

Hardware Reference Manual

Document Number: 100092-00
Revision F

March 2016

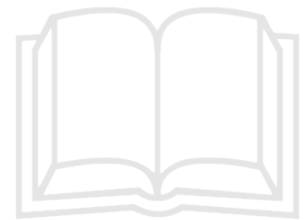

Table of Contents

1. Preface4

1.1. Purpose.....4

1.2. Applicability4

1.3. Notices.....6

1.4. Compliance.....6

2. Overview and System Requirements.....7

2.1. General Description7

2.2. Initial Inspection.....7

2.3. Options8

2.4. System Requirements10

3. Installation.....11

3.1. Integration.....11

3.2. Setup.....12

4. Operation13

4.1. Calibration13

4.2. Software Upgrades13

4.3. Controlling the Scanner and Acquiring Data.....13

4.4. Holdover Option Operation13

5. RF Antenna Information.....14

5.1. Antenna Verification.....14

5.2. Cellular Antennas.....14

5.3. GPS Antenna Information15

6. Walk Test Kit Information16

6.1. Walk Test Kits.....16

6.2. Indoor RF Antenna Information16

7. Troubleshooting.....17

7.1. No Power: Receiver LEDs not Illuminated17

7.2. Changing the Fuse in the Power Plug17

7.3. Received Signal Strength Appears Low17

8. Support18

8.1. Contact Information18

8.2. Warranty Information.....18

8.3. Calibration Notice.....19

8.4. Return Material Authorization Procedure for the SeeGull EXflex Scanning Receiver19

9. Accessories and Service Options20

9.1. Accessories20

9.2. Service Options.....20

List of Figures

<i>Figure 1 - SeeGull EXflex Scanning Receiver</i>	<i>7</i>
<i>Figure 2 - Front View of SeeGull EXflex Scanning Receiver Showing Connections.....</i>	<i>7</i>
<i>Figure 3 - SeeGull EXflex Scanning Receiver top view.....</i>	<i>11</i>
<i>Figure 4 - SeeGull EXflex Scanning Receiver side view</i>	<i>11</i>
<i>Figure 5 - SeeGull EXflex Scanning Receiver rear view</i>	<i>11</i>
<i>Figure 6 - SeeGull EXflex Scanning Receiver front display.....</i>	<i>12</i>
<i>Figure 7 - OP123.....</i>	<i>14</i>
<i>Figure 8 - OP278H.....</i>	<i>14</i>
<i>Figure 9 - OP278H and OP379H Gain.....</i>	<i>14</i>
<i>Figure 10 - OP379H.....</i>	<i>15</i>
<i>Figure 11 - OP034H.....</i>	<i>15</i>
<i>Figure 12 - OP207 Walk Test Kit</i>	<i>16</i>
<i>Figure 13 - SeeGull EXflex Scanning Receiver Power Plug</i>	<i>17</i>

List of Tables

<i>Table 1: Phone Numbers</i>	<i>18</i>
<i>Table 2: Email Addresses</i>	<i>18</i>
<i>Table 3: SeeGull EXflex Cables</i>	<i>20</i>
<i>Table 4: SeeGull EXflex Antennas.....</i>	<i>20</i>
<i>Table 5: SeeGull EXflex Walk Test Kit Accessories</i>	<i>20</i>
<i>Table 6: SeeGull EXflex Calibration Service</i>	<i>21</i>
<i>Table 7: SeeGull EXflex Repair Service</i>	<i>21</i>
<i>Table 8: SeeGull EXflex Warranty Options.....</i>	<i>21</i>

1. Preface

1.1. Purpose

This document is a reference manual for the SeeGull EXflex. It describes the main features and options available for SeeGull EXflex scanner and provides instructions related to setup, operation, and maintenance of the scanners. This document may be supplemented by other documentation for SeeGull EXflex scanner or related PCTEL products and applications.

1.2. Applicability

The SeeGull EXflex Scanning Receiver conducts drive test and site-specific measurements of mobile networks around the world to optimize wireless network performance, survey tower sites, monitor base stations, demodulate RF signals and analyze wireless market data.

The SeeGull EXflex Scanning Receiver is a software-defined receiver, capable of supporting multiple protocols and any supported cellular band. Two configurations are available: the 6900 model which supports frequencies between 300 MHz and 3.8 GHz and the 6901 model with supports frequencies between 150 MHz and 6 GHz. It can be configured for TD-LTE, LTE FDD, UMTS [WCDMA/HSPA(+)], CDMA, EV-DO, GSM and TD-SCDMA technologies which can all be measured simultaneously. The following bands are supported for LTE FDD with a subset of these bands supported for UMTS [WCDMA/HSPA(+)], CDMA, EV-DO and GSM:

- R-GSM-900
- E-UTRA 1 (2100 MHz UMTS)
- E-UTRA 2 (1900 MHz)
- E-UTRA 3 (1800 MHz)
- E-UTRA 4 (2100 MHz AWS)
- E-UTRA 5 (850 MHz)

- E-UTRA 6 (850 MHz Japan)
- E-UTRA 7 (2600 MHz IMT)
- E-UTRA 8 (900 MHz UMTS)
- E-UTRA 9 (1700 MHz Japan)
- E-UTRA 10 (Ext. 2100 MHz AWS)
- E-UTRA 11 (1500 MHz Japan)
- E-UTRA 12 (Lower 700 MHz A/B/C)
- E-UTRA 12/17 Lower 700 MHz A/B/C and Lower 700 MHz B/C)
- E-UTRA 13 (Upper 700 MHz C)
- E-UTRA 13/14L (Upper 700 MHz C and lower half Upper 700 MHz D)
- E-UTRA 14 (Upper 700 MHz D)
- E-UTRA 17 (Lower 700 MHz B/C)
- E-UTRA 18 (Lower 800 MHz Japan)
- E-UTRA 19 (Upper 800 MHz Japan)
- E-UTRA 20 (800 MHz EU)
- E-UTRA 21 (1510 MHz Japan)
- E-UTRA 22 (3500 MHz)
- E-UTRA 23 (2000 MHz)
- E-UTRA 25 (1990 MHz [Ext. 1900])
- E-UTRA 26 (Upper Ext 850 MHz)
- E-UTRA 27 (Lower Ext 850 MHz)
- E-UTRA 28 (700 MHz APAC)
- E-UTRA 29 (US 700 MHz)
- E-UTRA 30 (2300 MHz WCS)
- E-UTRA 31 (450 MHz)
- E-UTRA 66 (AWS-3)

The following bands are supported for TD-LTE:

- E-UTRA 33 (1900 MHz)
- E-UTRA 34 (2000 MHz)
- E-UTRA 35 (1900 MHz Lower)
- E-UTRA 36 (1900 Upper)
- E-UTRA 37 (1900 MHz Center Gap)
- E-UTRA 38 (2.6 GHz)
- E-UTRA 39 (1.9 GHz)
- E-UTRA 40 (2.3 GHz)
- E-UTRA 41 (2.5 GHz)
- E-UTRA 42 (3.4 GHz)
- E-UTRA 43 (3.6 GHz)
- E-UTRA 44 (700 MHz)
- TDD Proprietary (1.4 MHz)

For more information about the SeeGull EXflex, please contact your sales or marketing representative (contact information provided in *Section 8*).

Features

- Fast scanning speeds
- High dynamic range
- Low false detection rate
- Built-in GPS
- LTE FDD Measurement Averaging
- Blind Scan for all technologies
- LTE (FDD), TD-LTE, UMTS (WCDMA/HSPA+), GSM Layer 3
- USB Interface
- Plug-and-play capabilities
- Compatibility with industry-leading drive test, data analysis, and RF planning tools
- Modular architecture for easy upgrades
- Sleek, durable design

Supported Measurements

LTE (FDD and TDD)

- Maximum # of Channels: 24
- eTop N Reference Signal Scan
- P-SCH/S-SCH
- RSRP, RSRQ
- CINR
- Cyclic Prefix
- Time Offset
- Multi-Path Delay Spread

TD-LTE Specific

- Uplink/Downlink Configuration #
- DwPTS Symbol

GSM

- BSIC Decoding Scan
- RSSI Channel Scan
- C/I (Co-Channel Interference)

UMTS [WCDMA/HSPA+]

- Maximum # of Channels: 24
- Top N Scan

- P-SCH/S-SCH Scan
- Io
- Ec/Io and Aggregate Ec/Io
- Signal to Interference Ratio (SIR)
- Rake Finger Count
- Time Offset
- Delay Spread

CDMA

- Maximum # of Channels: 24
- Top N Scan
- Ec
- Ec/Io and Aggregate Ec/Io
- Pilot Delay and Delay

EV-DO

- Maximum # of Channels: 24
- Top N Scan
- Ec
- Ec/Io and Aggregate Ec/Io
- Pilot Delay and Delay

TD-SCDMA

- Maximum # of Channels: 34
- Top N Beacon Scan
- Ec
- Io
- P-CCPCH Midamble Ec/Io
- Sync DL Ec/Io
- Signal to Interference Ratio (SIR)
- Time Offset

MULTI-TECHNOLOGY

- Aggregate Power measurement (RSSI, EPS or Spectrum Analysis)
- Delay and Signal Strength of neighboring cells
- RSSI Channel Scans
- Spectrum Analyzer measurements
- High Performance GPS Receiver
- **Blind Scan**

Blind Scan is available for LTE FDD, TD-LTE, UMTS [WCDMA/HSPA], GSM, CDMA, EV-DO and TD-SCDMA

technologies. This feature scans the selected band and provides the active channel numbers. Blind Scan is useful for conducting a full band network search where prior knowledge about active channels is incomplete or unknown. It is also beneficial for network benchmarking to obtain a first-glance view of the RF infrastructure density and configuration.



ISO Compliance

RF Solutions Quality Management System has been certified to be compliant with ISO 9001:2008.

For more information please visit www.pctel.com.

1.3. Notices

WARNING: These devices have no protection against lightning. Please turn off the scanning receiver during a thunderstorm and, if applicable, take the antenna inside the car before a thunderstorm approaches. The scanning receiver itself is not intended for “in weather” outdoor use.

NOTICE: There are no user serviceable parts inside the SeeGull EXflex Scanning Receiver.

1.4. Compliance

RoHS Compliance

The PCTEL SeeGull EXflex Scanning Receiver being delivered to participating European nations is compliant to EU Directive 2002/95/EC (RoHS).

The PCTEL SeeGull EXflex Scanning Receiver is compliant to "Administrative Measure on the Control of Pollution Caused by Electronic Information Products" ("China RoHS").

2. Overview and System Requirements

This section describes the SeeGull EXflex Scanning Receiver, including the applicable system configuration and software requirements.

2.1. General Description

The SeeGull EXflex is a tool for signal strength and modulation measurement, engineered for the rigors of mobile network testing during planning, installation and maintenance of wireless networks. The SeeGull EXflex is shown in *Figure 1*.

The USB communication link allows the host to control the operation of the scanner and to receive measurement results. (Refer to *Section 4* for more details.)



Figure 1 - SeeGull EXflex Scanning Receiver

2.2. Initial Inspection

Upon receipt of the scanning receiver, inspect the shipping container and verify that the contents are complete and match the packing list. The EXflex receiver should look similar to the picture in *Figure 2*. If the contents are incomplete or the SeeGull EXflex Scanning Receiver appears damaged, please call the Technical Support line at (240) 460-8833.

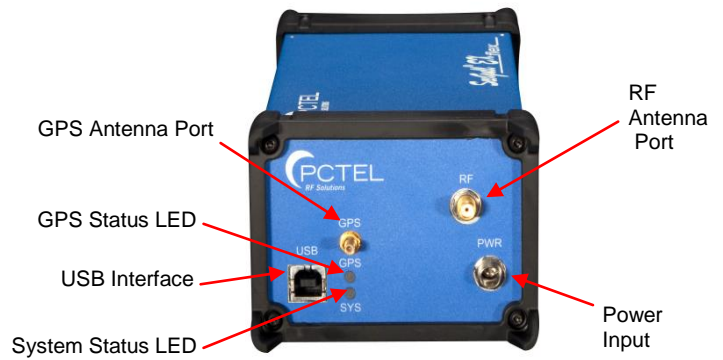

Figure 2 - Front View of SeeGull EXflex Scanning Receiver Showing Connections

2.3. Options

Optional multi-technology measurements available for the SeeGull EXflex are described below. These options can be installed at the time of purchase or later on as a field upgradeable option with the exception of OP640, CDMA/EV-DO Holdover Option. Refer to section 9 for a complete list of options available for the SeeGull EXflex Scanning Receiver and their part numbers. Please contact your PCTEL sales or marketing representative for pricing and delivery information.

Enhanced Power Scan (EPS™) Option (OP602)

EPS Mode provides customizable power measurements, improving flexibility and precision over RSSI and Spectrum Analyzer measurements for highly-tuned analysis of individual parts of the RF signal. EPS features include:

- Absolute Time Stamp
- Auto and Immediate Measurement Modes
- Ability to set both Time and Frequency parameters
- Measure Frequency Spans from 7.5 kHz to 20 MHz user selectable in multiples of 2.5 kHz
- Measures Time Periods from 1 chip (50 µs) to 20,000 chips (1sec)

Spectrum Analyzer Option (OP601)

The built-in Spectrum Analyzer feature provides an effective means to detect and troubleshoot frequency-related problems. The Spectrum Analyzer shows a wealth of information about the signal spectrum that is not obtainable from the standard channel power measurement. The Spectrum Analyzer measures and reports power spectral density using frequency domain techniques (a segmented FFT approach

that ensures various resolution bandwidths and fast update rates), whereas RSSI measurements use analog and digital filters to select the right frequency band and subsequently measure total power.

One advantage of this approach is that the Spectrum Analyzer can analyze the fast-changing spectrum of an unstable transmitter. The RSSI measurement in this case will most often show a normal smooth picture, as it averages a limited set of data over time. The Spectrum Analyzer, however, if used with an appropriate resolution bandwidth, will reveal erratic signal behavior due to its fast update rate and unaveraged data.

The user may set the resolution bandwidth to 5, 10, 20, 40, 80 or 160 kHz or 2, 4 or 8 MHz. Output data may be set to an average of 1, 2, 4, 8, or 16 sweeps.

LTE Power Analysis (OP632)

LTE Power Analysis is available for TD-LTE and provides power of the resource block and slot of the TD-LTE frame. This enables users to identify interference that is time (slots) or frequency (RBs)-selective, to obtain a snapshot of overall traffic levels, and to determine whether base station is properly using the available resources.

Layer 3 Options

(OP620 All Layer 3 Options)

(OP620-GSM)

(OP620-WCDMA)

(OP620-FD-LTE)

(OP620-TD-LTE)

(OP620-TD-SCDMA)

Layer 3 decoding is available for LTE FDD, TD-LTE, GSM, UMTS [WCDMA/HSPA(+)] and TD-SCDMA technologies. This option, provides decoding for:

- GSM BCCH (Broadcast Control Channel) messages
- UMTS [WCDMA/HSPA(+)] BCH (Broadcast Control Channel) Type 3 messages

In the GSM BCCH, types 1, 2, 3, 4, 9, and type 13 messages are supported. For WCDMA, TD-SCDMA and LTE, transport block from the scanner enable support of the Master Information Block (MIB) and System Information Blocks (SIBs).

In the UMTS [WCDMA/HSPA(+)] BCH, the MIB and SIBs 1, 2, 3, 5, 7, 11 and 19 are available.. In the TD-SCDMA the MIB and SIBs 1, 3, 5, 5bis, 7, 11 and 19 are available.

In the GSM BCCH,UMTS [WCDMA/HSPA(+)] and the TD-SCDMA BCH, these messages contain the Cell Identity and Local Area Identification information broadcast by the network infrastructure. This information includes the:

- MCC (Mobile Country Code),
- MNC (Mobile Network Code),
- LAC (Location Area Code)
- RAC (Routing Area Code)

These messages also contain significant information on the configuration, activity and performance of the network. This includes information concerning:

- Neighbor list
- Mobility management (handovers, etc.)
- Group and broadcast call control

- GPRS mobility management, transparent transport and session management
- Radio resource management
- SMS messages
- Location services
- Uplink Interference parameters (UMTS [WCDMA/HSPA(+)] only).

The LTE BCCH layer 3 option conveys system information about the cell. These transport blocks contain the cell identity, channel bandwidth, mobility management (handovers), neighbor lists, barred cells, intra-frequency selection, public safety messages, etc. It supports decoding of the MIB and SIBs 1-13.

The SeeGull EXflex supports scanning of numerous GSM and LTE BCCH, and UMTS [WCDMA/HSPA(+)] and TD-SCDMA BCH channels during the same test.

GSM C/I Option (OP631)

A C/I option is available for the GSM SeeGull EXflex Scanning Receiver. This option provides co-channel interference (C/I) measurements as well as decoding of BSIC (Base Station Identification Code).

CDMA/ EV-DO Holdover Option (OP640)

The Holdover Option enables users to collect measurements even when a GPS signal is not present for CDMA/EV-DO technologies. This option maintains the stability of the internal clock for a greater period in the absence of the GPS signal (normally the GPS signal is used for this). Examples include indoor applications, driving through tunnels or in urban areas, where maintaining GPS (which is used by the EXflex scanning receiver for both location and timing) is difficult. (See Section 3 Operations for more details.)

2.4. System Requirements

This section describes the system requirements for the SeeGull EXflex Scanning Receiver.

Typical System

Depending on a user's requirements, various hardware and software components may be used in the scanning system along with the SeeGull EXflex Scanning Receiver. However, in most cases, a typical configuration will include a host PC connected to the scanning receiver via a USB cable and running the user's application software.

Antenna Requirements

Use a 50 Ohm impedance antenna with an SMA male connector at the end of the cable. Refer to PCTEL's product offering matrix in the back of this document for part number information.

Note: Outdoor antennas, including those used by other devices, should be placed a minimum of 6 in. (15 cm) apart, with a recommended distance of 34 in. (86 cm). Refer to the Instructional Guide: **SeeGull Antennas for MIMO and MISO Antenna Schemes** for further details.

Power Source Requirements

Maximum power the SeeGull EXflex Scanning Receiver draws:

- 21 watts (max)
- 17 watts (typical)

Voltage range for the EXflex Scanning Receiver:

- 8 to 16 VDC

Use a car battery, a 12-volt battery, or an AC/DC adapter. It is imperative that the power source be capable of supplying the receiver with the voltage and current levels as described above. It is HIGHLY recommended that the power supply not exceed the working DC voltage range of the scanning receiver. Applying excessive voltage to the receiver will void the unit's warranty.

The scanning receiver should be powered through the power cord provided by PCTEL. If another power cord is used, the power cord must be one that incorporates a fuse for protection and safety purposes or this will void any warranties.

3. Installation

This section describes how to set up the SeeGull EXflex Scanning Receiver.

3.1. Integration

There are sixteen (16) mounting holes (4-40 screw) on the chassis of the unit that are used for mounting in the user's enclosure/rack. Note that the maximum depth of screw insertion from the chassis exterior is 1/4". Refer to *Figure 3* and *Figure 4*. Care should be taken when mounting this unit in a system enclosure, rack, or case, not to obstruct airways. Unobstructed convection airflow is recommended.

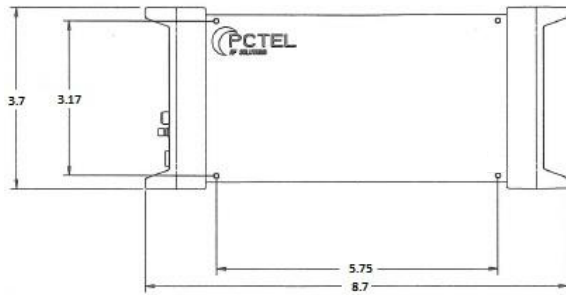

Figure 3 - SeeGull EXflex Scanning Receiver top view.

Note: Do not obstruct air intakes or exhaust on unit. Do not place the unit intakes next to the exhaust of another heat source.

Airway intakes are located on the left and right sides of unit as shown in *Figure 4* and *Figure 5*. Fan exhaust on rear of unit.

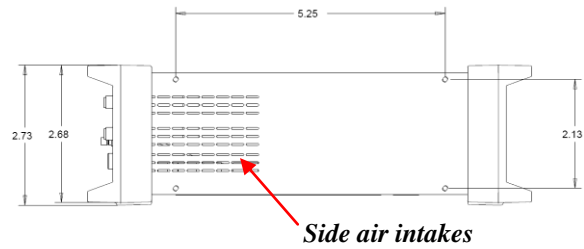

Figure 4 - SeeGull EXflex Scanning Receiver side view

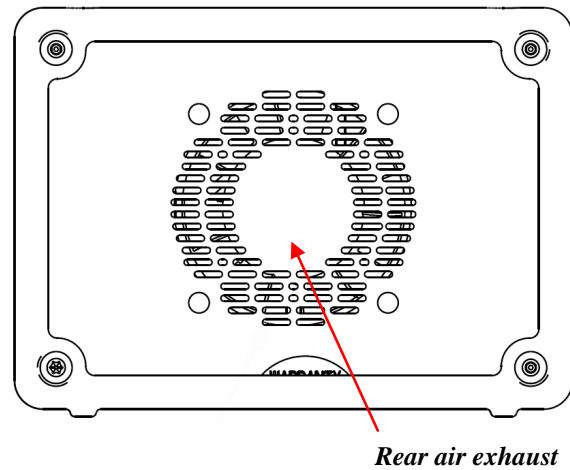

Figure 5 - SeeGull EXflex Scanning Receiver rear view

3.2. Setup

The following steps explain how to connect the unit to the host PC and power source and to begin collecting data.

1. Connect the antennas to the SMA connectors on the unit (*Figure 6*).
2. Connect the GPS antenna (or input) to the SMB connector.
3. Connect the USB data cable to both the SeeGull EXflex scanning receiver and to a PC USB port.
4. Connect the power cable to the SeeGull EXflex Scanning Receiver and to the car cigarette lighter adapter. After the power is applied, the LED on the receiver blinks orange. After a short delay, the light turns green. If the light turns dark red, the unit has failed the power-up test. Please contact Customer Support.
5. Install and start the PC program. If you are using SeeHawk refer to the SeeHawk User Manual for specific instructions.
6. The system is ready for use.

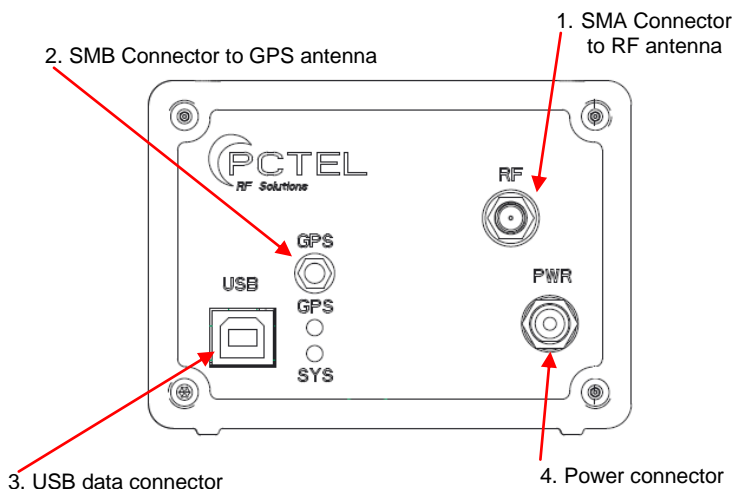

Figure 6 - SeeGull EXflex Scanning Receiver front display

4. Operation

This section discusses calibration, software upgrades, and integrating the SeeGull EXflex scanning receiver into the user's test system.

4.1. Calibration

SeeGull EXflex scanning receivers are calibrated at the factory. The calibration data is stored in the internal non-volatile memory for each 1 dB step for the whole input signal dynamic range. Recalibration is recommended every year in order to maintain the specified accuracy levels. Please refer to the Calibration Notice in Calibration section for more information. Re-calibration is available as an optional service from PCTEL Inc., RF Solutions.

Note: It is highly recommended to have the SeeGull EXflex Scanning Receiver recalibrated every year.

4.2. Software Upgrades

SeeGull EXflex scanning receiver stores the application program in internal non-volatile memory, and accordingly, is capable of being upgraded via software. Upgrades may be needed to incorporate new features or bug fixes. Please note that some upgrades can only be performed at PCTEL's factory.

4.3. Controlling the Scanner and Acquiring Data

A unit is controlled, and the measurement data is received via the USB data cable. Control of the SeeGull EXflex scanning receiver is dependent upon the PC software in order to collect data coming from measurements taken from the SeeGull EXflex scanning receiver.

4.4. Holdover Option Operation

When a GPS signal is present, CDMA and EV-DO technologies use the GPS data for timing information to decode the signals. With the Holdover option, the SeeGull EXflex will continue to accurately decode the pilots and cell IDs for a period of 4 hours in the absence of any GPS signal. To get the best performance of the Holdover option during indoor measurements, we recommend that the GPS be locked for at least 30 minutes before using the SeeGull EXflex scanning receiver in an unlocked / holdover mode (with power maintained).

5. RF Antenna Information

This section discusses antennas that are used with the SeeGull EXflex Scanning Receiver system.

5.1. Antenna Verification

Verify that all the necessary antennas are included in the shipment and that each is marked. Each antenna comes in a bag labeled with the antenna's model number and its corresponding frequency range, while the antenna itself is labeled by the frequency range.

5.2. Cellular Antennas

PCTEL offers several antennas that are industry superior antennas supporting low dB loss cable, extended temperature ranges and a frequency range wide enough to cover PCTEL's SeeGull EXflex Scanning Receiver.



Figure 7 - OP123

The OP123 supports a frequency range of 450 to 512 MHz. It provides unity gain¹ of 1 dBi across the entire spectrum. The antenna comes standard with a magnetic

¹ dBi gain does not include base and cable losses. Gain measured on a 1x1 foot ground plane.

mounting base and a male SMA² connector for the RF, as shown in Figure 7.



Figure 8 - OP278H

The OP278H supports a wide frequency range from 698 MHz to 3.8 GHz. The antenna gain is shown in Figure 9. The antenna comes standard with a magnetic mounting base and a male SMA² connector for the RF, as shown in Figure 8.

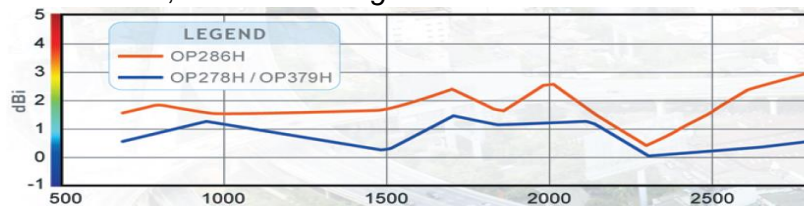

Figure 9 - OP278H and OP379H Gain

The OP379H shown in Figure 10 supports a wide frequency range from 698 MHz to 3.8 GHz. The antenna gain is shown in Figure 9. These antennas come standard with a male SMA² connector for the RF and

² Torque specification for SMA connector is 3-5 in-lb (0.3 – 0.6 N-m)

an SMB (push-on/pull-off) adapter for the GPS.



Figure 10 - OP379H

5.3. GPS Antenna Information

PCTEL offers a single standalone GPS antenna, the OP034H. The OP034H is a High Gain GPS standalone antenna which comes standard with a magnetic mounting base and a SMB connector. See *Figure 11*.



Figure 11 - OP034H

6. Walk Test Kit Information

This section discusses walk test options that can be used with the SeeGull Scanning Receiver system.

Deployment of wireless data services is resulting in further increases of in-building traffic and coverage requirements. The measurement, enhancement and optimization of indoor coverage are now an increasingly important aspect of wireless engineering.

The PCTEL SeeHawk Walk Test Kit comprises a complete set of accessories that enable the indoor use of the PCTEL SeeGull EXflex Scanning Receiver. The Walk Test Kit provides a cost effective solution for evaluating existing in-building coverage and for planning, deploying and testing indoor coverage systems.

The PCTEL's Walk Test Kit provides the right solution for "Walk Testing" that enables wireless engineers to address the three key steps of in-building coverage assessment and planning:

- Evaluating In-building Coverage from Outside Networks
- Planning New In-Building Networks
- Coverage Validation for New or Existing In-Building Networks

6.1. Walk Test Kits

PCTEL offers a Walk Test Kit for the SeeGull EXflex Scanning Receiver, the OP207 Walk Test Kit as shown in *Figure 12*. It delivers a convenient way to carry and power the SeeGull EXflex Scanning Receiver for indoor measurements. The OP207 Walk Test Kit consists of:

- Carrying case
- Battery Pack w/ Battery Case
- Battery Charger w/ Power Cord
- EX USB Data Cable



Figure 12 - OP207 Walk Test Kit

6.2. Indoor RF Antenna Information

PCTEL offers wideband rubber duck style antennas for indoor use. There are three models depending on the frequency required.

- OP293: Indoor Ant. 700-1100 MHZ, 1475-2700 MHZ
- OP241: Indoor Ant., 698-2700 MHZ

7. Troubleshooting

This section describes a few suggestions for several common problems that might occur. These suggestions are user serviceable.

7.1. No Power: Receiver LEDs not Illuminated

If the SYS LED located on the face of the scanning receiver is not illuminated, please check the connection first, then the fuse, which is located in the cigarette lighter end of the power cord.

Note: Check The Fuse in the Cigarette Lighter Plug First!

The fuse can be “blown” by a surge in the portable or mobile battery system. A temporarily shorted wire can also cause other problems.

If the fuse is not operating normally, it will open up, thereby disconnecting the input power from the SeeGull EXflex Scanning Receiver. The fuse is the first line of defense should any short circuit, large spike, or other problems occur within the power wiring circuitry. When the fuse “blows”, there will be no power to the receiver.

7.2. Changing the Fuse in the Power Plug

If it is necessary to change the fuse in the power plug, remove the cigarette lighter plug end from the power source. See *Figure 13* for an illustration of the power plug.

Loosen the fuse-holding finger nut by turning it counter-clockwise until the plug comes apart. The fuse is inside the power plug housing and can be removed.

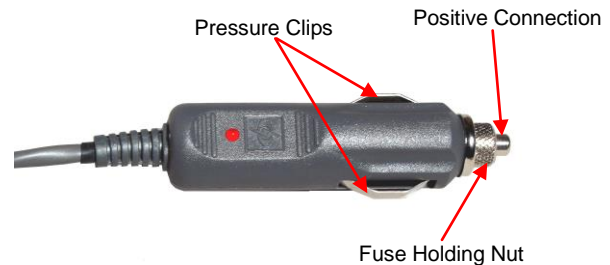

Figure 13 - SeeGull EXflex Scanning Receiver Power Plug

Replace the fuse with an identical 3-amp fuse.

Note: Only use a 3-amp fuse (EXflex); any other fuse value may cause severe problems with the unit and void the warranty. In order not to violate the safety approval of the receiver, the fuse must be safety approved.

Insert the new fuse in the housing and re-assemble the plug by turning the knurled finger nut in a clockwise direction. Tighten this nut as tight as you can with your fingers.

Note: Do Not Use Tools to Tighten.

7.3. Received Signal Strength Appears Low

If the received signal strength appears to be lower than expected, it is likely that (1) an incorrect antenna is being used, (2) an antenna is not properly connected or (3) the antenna or antenna cable is damaged.

Check that the antenna is properly connected to the scanning receiver, and that the antenna is of the correct frequency.

8. Support

This section provides support information, including PCTEL RF Solutions Group contacts, warranty information, calibration notice, and technical specifications.

8.1. Contact Information

Phone Numbers	
Departments	Contact Information
CUSTOMER SUPPORT / RMA REQUESTS	+1-240-460-8833
QUALITY MANAGER	+1-301-444-2045
SALES	+1-301-515-0036

Table 1: Phone Numbers

Email Addresses	
Departments	Contact Information
PRODUCT FEEDBACK	PRODUCTFEEDBACK@PCTEL.COM
CUSTOMER SUPPORT / RMA REQUESTS	SUPPORT.RFSG@PCTEL.COM
QUALITY MANAGER	QUALITY.RFSG@PCTEL.COM
SALES	RFS.SALES@PCTEL.COM

Table 2: Email Addresses

8.2. Warranty Information

WARRANTY

PCTEL warrants that the Product will be free from defects in material and workmanship for a period of five (5) years from the date of shipment under normal use and operation. PCTEL's sole and exclusive obligation under the foregoing warranty shall be, at its option, to repair or replace

any defective Product, which fails during the warranty period, provided that PCTEL receives written notice of the defect during the warranty period. The expense of removal and reinstallation of any item(s) of equipment is not included in this warranty. This warranty shall only apply to the Product purchased or licensed and shall not apply to any other equipment and its removal and reinstallation. THE FOREGOING WARRANTY IS EXCLUSIVE AND IN LIEU OF ALL OTHER WARRANTIES, EXPRESS OR IMPLIED, INCLUDING THE IMPLIED WARRANTIES OF MERCHANTABILITY OR FITNESS FOR A PARTICULAR PURPOSE. Repair or replacement in the manner provided above shall be the sole and exclusive remedy of Buyer for breach of warranty and shall constitute fulfillment of all liabilities of PCTEL with respect to the quality and performance of the Products. PCTEL shall have no obligation to make repairs or replacement necessitated by catastrophe, fault, negligence, misuse, abuse or accident of Buyer or other users. IN NO EVENT SHALL PCTEL BE LIABLE FOR ANY SPECIAL, INCIDENTAL OR CONSEQUENTIAL DAMAGES TO BUYER OR ANY THIRD PARTY ARISING OUT OF THESE TERMS AND CONDITIONS OR ANY DEFECTIVE PRODUCT WHETHER THE DEFECT IS WARRANTED AGAINST OR NOT, WHETHER THE CLAIM IS BASED UPON CONTRACT, TORT, STRICT LIABILITY OR OTHERWISE, NOR SHALL PCTEL BE LIABLE TO BUYER FOR ANY AMOUNT EXCEEDING THE PURCHASE PRICE OF THE PRODUCT.

Warranty Procedures

See Return Material Authorization (RMA) Process further below.

8.3. Calibration Notice

Note: It is highly recommended to have the SeeGull EXflex Scanning Receiver recalibrated every year.

SeeGull EXflex Scanning Receiver is calibrated at the factory. The calibration data is stored in the internal non-volatile memory in 1 dB steps for the whole input signal dynamic range. Recalibration is recommended every year in order to maintain the specified accuracy levels. Recalibration is available as an optional service from PCTEL RF Solutions Group.

The SeeGull EXflex Scanning Receiver is calibrated for several sources of variations including amplitude levels, ambient temperature, input frequency, and internal noise levels for narrow and wide channel bandwidths. The calibration parameters are stored as single values or arrays in the scanning receivers' non-volatile memory. Automated test and calibration stations use proprietary software which performs the process with no or minimum human intervention. The calibration process is followed by a fully automated production test. The test results are stored in a central quality database and they are extracted and used for periodic quality audits.

Every unit that passes the calibration and test process successfully receives a Certificate of Calibration. This Certificate is shipped back with the unit.

The complexity of the calibration process precludes field calibration. It is highly recommended that PCTEL's scanning receivers be returned to the factory annually to maintain the units' exceptional measurement capability.

8.4. Return Material Authorization Procedure for the SeeGull EXflex Scanning Receiver

NOTICE: There are no user serviceable parts inside the SeeGull EXflex Receiver. *Any tampering with the components within the unit will void any applicable warranties.*

All repairs must be performed by PCTEL in accordance to the procedure outlined below:

1. Complete the RMA form on the website at:

http://rfsolutions.pctel.com/rfs_rma_form.cgi

Alternatively, you can provide the information (your name and contact information, the company's name and address, the serial number and protocol of the unit, and a description of the problem) via fax at +1 (301) 515-0037.

2. A response including an RMA number and in-warranty or out-of-warranty information will be provided within 24 hours, or the next working day.
3. Please ship the unit to:

PCTEL, Inc.
RF Solutions Group
Attn: RMA Coordinator
20410 Observation Drive
Suite 200
Germantown, MD 20876
+1 240.460.8833

4. Reference PCTEL's RMA number on all shipping documentation.

Note: Units shipped without an RMA number may be returned to the customer without the unit being repaired.

9. Accessories and Service Options

9.1. Accessories

SeeGull EXflex Scanning Receiver Accessories	
Cables and Keys	
Part Number	Description
OP203	EX/EXFLEX POWER CABLE, CAR LIGHTER - 9'
OP204	EX/EXFLEX USB DATA CABLE
OP143	EXTRA USB KEY, HASP4

Table 3: SeeGull EXflex Cables

Antennas	
Part Number	Description
OP034H	ANT, GPS HIGH GAIN
OP123	ANT, 450-512 MHZ MULTI-BAND MAG. MOUNT, HIGH PERFORMANCE
OP278H	ANT, 698-3800 MHZ MULTI-BAND MAG. MOUNT, HIGH PERFORMANCE
OP379H	ANT, 698-3800 MHZ MULTI-BAND MAG. MOUNT W/ GPS, HIGH PERFORMANCE
OP241	INDOOR ANTENNA 698-2700 MHZ
OP293	INDOOR ANTENNA 700-1100 MHZ, 1475-2700 MHZ

Table 4: SeeGull EXflex Antennas

Walk Test Kits, Battery Packs	
Part Number	Description
OP024	UNIV INPUT AC/12VDC ADPT.
OP207	WALK TEST (INDOOR) KIT - CX/EX/EXFLEX INCLUDES BAG, BATTERY KIT AND PC TO SCANNING RECEIVER CABLE; MUST PURCHASE INDOOR ANTENNA SEPARATELY
OP206	BATTERY KIT - EX/EXFLEX/EX+ LITEPACK INCLUDES BATTERY, CHARGER, 2 CORDS FOR US AND EU, BATTERY POUCH
OP431	WALK TEST (INDOOR) KIT (DUAL BATTERY VERSION) - MX/EXFLEX/EX FAMILY INCLUDES BAG, BATTERY KIT AND PC TO SCANNING RECEIVER CABLE; MUST PURCHASE INDOOR ANTENNA SEPARATELY
OP417	DUAL BATTERY POWER PACK AND CHARGER KIT - MX/EXFLEX/EX FAMILY INCLUDES 2 BATTERIES, US POWER CORD AND EU ADAPTER
OP205	SPARE BATTERY CABLE AND BAG - EX/EXFLEX/EX+ LITEPACK
OP137	SPARE US BATTERY POWER CORD
OP138	SPARE EU BATTERY POWER CORD

Table 5: SeeGull EXflex Walk Test Kit Accessories

9.2. Service Options

SeeGull EXflex Service Options	
Calibration Services	
Part Number	Description
OPS130	CALIBRATION CHECK: SEEGULL EXFLEX RECEIVER
OPS131	FULL CALIBRATION FOLLOW-ON: SEEGULL EXFLEX RECEIVER
OPS132	FULL CALIBRATION: SEEGULL EXFLEX RECEIVER
OPS133	EXTENDED CALIBRATION REPORT: EXFLEX RECEIVER

Table 6: SeeGull EXflex Calibration Service

Fixed Cost Repair Service	
Part Number	Description
OPR05	RMA EVALUATION FEE: QUOTED TO CUSTOMERS WITH UNITS OUTSIDE OF WARRANTY WHO SEND UNITS IN FOR EVALUATION. ONLY CHARGED IF UNIT DOES NOT NEED REPAIR. IF REPAIR IS NEEDED, THE CUSTOMER PAYS THE FIXED COST REPAIR PRICE.
OPR32	FIXED COST REPAIR: SEEGULL EXFLEX RECEIVER

Table 7: SeeGull EXflex Repair Service

Warranty Extensions	
Part Number	Description
OPS134	1 YR EXTENDED WARRANTY: SEEGULL EXFLEX RECEIVER

Table 8: SeeGull EXflex Warranty Options

For further information please contact your PCTEL sales or marketing representative.

Trademarks

© 2016 PCTEL, Inc. All rights reserved. PCTEL, SeeHawk[®] Collect, SeeHawk Collect logo, SeeHawk[®] Touch, SeeHawk Touch logo, SeeWave[®], SeeWave logo, SeeGull[®], MXflex[®], IBflex[®], EXflex[®], and the PCTEL logo are trademarks of PCTEL, Inc.

Android[™] is a trademark of Google Inc.

Bluetooth[®] is a registered trademark of Bluetooth SIG.

Samsung[®] and Galaxy Tab[®] S are registered trademarks of Samsung Electronics, Co. Ltd.

Windows[®] is a registered trademark of Microsoft Corporation.

Notices and Warranty Information

The information in this document is subject to change without notice. PCTEL assumes no responsibility or makes no warranties for any errors that may appear in this document and disclaims any implied warranty of merchantability or fitness for a particular purpose. Further, PCTEL shall not be liable for incidental, consequential or other damages in connection with the use of this document.

Copyright Information

No part of this document may be used or reproduced in any form or any means, in whole or in part, without prior written consent of PCTEL.

Restrictions

This document contains proprietary information that is protected by copyright; it is intended for use by PCTEL and its customers only. It is not to be disclosed to a third party. All rights reserved. No part of this document may be photocopied or reproduced in any way without the prior written permission of PCTEL, Inc. The information contained in this document is subject to change without notice. PCTEL makes no warranty of any kind relating to this document.

All Rights Reserved

Copyright 1997-2016

PCTEL, Inc.
RF Solutions
20410 Observation Drive, Suite 200
Germantown, MD 20876 USA
Phone: +1 301 515 0036
Fax: +1 301 515 0037

