

# INSTRUCTION MANUAL

## *ARC FUSION SPLICER*

# **FSM-60S**

**Please read this instruction manual carefully  
before operating the equipment.**

**Adhere to all safety instructions and  
warnings contained in this manual.**

**Keep this manual in a safe place.**

 **Fujikura**



---

***Warning and Caution* ..... 3**

***Introduction* ..... 9**

***Description of Product* ..... 12**

1. Components of Splicer ..... 12

2. Other Necessary Items for Splicing Operation ..... 14

3. Description and Function of Splicer ..... 16

***Point of the splice procedure*..... 20**

1. To get a stable low splice loss ..... 20

2. Power Supply..... 25

***Basic Operation* ..... 26**

1. How to use the work table on the carrying case ..... 26

2. Inserting Power Supply to Splicer ..... 28

3. Turning splicer "ON" ..... 34

4. Cleaning optical fiber ..... 36

5. Placing protection sleeve over fiber..... 36

6. Stripping and cleaning fiber ..... 36

7. Fiber Cleaving ..... 38

8. Loading fiber to splicer ..... 40

9. Splicing procedure ..... 43

10. Removing spliced fiber ..... 48

11. Heating protection sleeve ..... 48

***Maintenance of Splicing Quality*..... 52**

1. Cleaning and Checking before Splicing ..... 52

2. Periodical Checking and Cleaning..... 54

***Splice Menu* ..... 58**

1. Splice Mode ..... 58

2. Splice Option ..... 73

3. Splice Memory ..... 74

4. Splice Memory Comment ..... 79

***Heater Menu*..... 80**

1. Heater Mode..... 80

2. Auto Start..... 83

***Setting Menu*..... 84**

1. Splice Settings ..... 84

2. Maintenance Settings ..... 86

3. Machine Settings..... 87

4. Menu Lock Settings ..... 91

<b><i>Maintenance Menu</i></b> .....	<b>92</b>
1. Replace Electrodes.....	93
2. Stabilize Electrodes.....	94
3. Clear Arc Count.....	94
4. Battery Discharge .....	95
5. Set Calendar.....	96
6. Maintenance Info.....	96
7. Diagnostic Test Function.....	97
8. Dust Check .....	98
9. Arc Calibration .....	99
10. Motor Calibration .....	101
11. Motor Drive .....	101
<b><i>Error Message List</i></b> .....	<b>102</b>
<b><i>Questions and Troubleshooting</i></b> .....	<b>110</b>
1. Power Supply .....	110
2. Splicing Operation.....	111
3. Tube-heating Operation .....	113
4. Supervising.....	113
5. Other Functions .....	114
<b><i>Guarantee and Contact Address</i></b> .....	<b>116</b>
6. Guarantee.....	116
7. Contact Address.....	117

The splicer has been designed for splicing Silica-based optical fibers for telecommunications. Do not attempt to use this machine for other applications. Fujikura Ltd. gives much consideration and regard to personal injury. Misuse of the machine may result in electric shock, fire and/or serious personal injury.

## Follow all safety instructions

Read and understand all safety instructions

## Stop using it when it malfunctions

Ask our service centers for repair as soon as possible.

## Instruction Manual

Read this instruction manual carefully before operating this machine.

Store this instruction manual in a safe place.

The following alert symbols are used in this instruction manual and machine to indicate warnings and caution for safe use. Understand the meanings of these symbols.



### WARNING

There is a possibility of death or serious injury resulting from improper use by ignoring this indication.



### CAUTION

There is a possibility of personal injury or physical loss resulting from improper use by ignoring this indication.



Symbol means "Pay attention"



Pay attention to hot surface!



Symbol means "Must not do"



You must not disassemble!



Symbol means "Must do"



You must disconnect a plug!

## Warning and Caution



### WARNINGS

- ⊘ Do not take the protector off the splicer, or consult your distributor for instruction. Tightening the original screw without the protector may damage mechanism inside.



An environmental performance decreases when the protector is detached.



## WARNINGS

Disconnect the AC power cord from the AC adapter inlet or the wall socket (outlet) immediately if user observes the following or if the splicer receives the following faults:



- Fumes, bad smell, noise, or over-heat occurs.
- Liquid or foreign matter falls into cabinet.
- Splicer is damaged or dropped.

If this occurs, ask our service center for repair. Leaving the splicer in a damaged state may cause equipment failure, electric shock or fire and may result in personal injury, death or fire.



Use only the AC adapter / battery charger (ADC-13) designed for this splicer.

Using an improper AC power source may cause fuming, electric shock or equipment damage and may result in personal injury, death or fire.



Use the supplied AC power cord. Do not place heavy objects on the AC power cord. Use of an improper cord or a damaged cord may cause fuming, electric shock or equipment damage and may result in personal injury, death or fire.



Do not disassemble or modify the splicer, AC adapter or battery. In particular, do not remove or bypass any electrical or mechanical device (e.g. a fuse or safety switch) incorporated into the design and manufacturing of this equipment.

Modification could cause damage that may result in personal injury, death, electric shock or fire.



Never operate the splicer in an environment where flammable liquids or vapors exist. Risk of dangerous fire or explosion could result from the splicer's electrical arc in such an environment.



Do not use compressed gas or canned air to clean the splicer. They may contain flammable materials that could ignite during the electrical discharge.



Do not touch the electrodes when the splicer is on and power is supplied to the unit. The electrodes generate high voltage and high temperatures that may cause a severe shock or burn.

**Note** Arc discharge stops when wind protector is opened. Turn the splicer off and disconnect the AC power cord before replacing electrodes.



Safety glasses should always be worn during fiber preparation and splicing operation. Fiber fragments can be extremely dangerous if it comes into contact with the eye, skin, or is ingested.

## Warning and Caution

### WARNINGS

Use only proper power source.

- Proper AC power source is AC100-240V, 50-60Hz. Check the AC power source before use. Proper DC power source is DC10-12V. Improper AC or DC power source may cause fuming, electric shock or equipment damage and may result in personal injury, death or fire.
- AC generators commonly produce abnormally high AC output voltage or irregular frequencies. Measure the output AC voltage with a circuit tester before connecting the AC power cord. Such abnormally high voltage or frequency from a generator may cause fuming, electric shock or equipment damage and may result in personal injury, death or fire. Make sure the generator is regularly checked and serviced.
- An AC Adapter Protection Circuit is included in the ADC-13 AC Adapter. If the “High AC Input” lamp of the AC adapter is lit or the protection circuit in the AC adapter is tripped, this indicates that the incoming voltage is dangerously high and may cause injury or damage to the equipment, as mentioned above. When using an AC generator with AC output voltage of AC220-240V especially, Fujikura Ltd. recommends the following measures to correct the condition.
  - (1) Connect a step-down transformer between the generator and the AC adapter in order to lower the AC voltage from AC220-240V to AC100-120V.
  - (2) Or, use an AC generator with AC output voltage of AC100V.
  - (3) Or, use an AC generator that has an inverter circuit to stabilize the output.



Do not modify, abuse, heat or excessively pull on the supplied AC cord. The use of a damaged cord may cause fuming, electric shock or equipment damage and may result in personal injury, death or fire.



The splicer uses a three-prong (core) AC cord that contains an earthed ground safety mechanism. The splicer **MUST** be Grounded. Use only the supplied three-prong (core) AC power cord. **NEVER** use a two-prong (core) power cord, extension cable or plug.



Connect AC power cord properly to the splicer (inlet) and wall socket (outlet). When inserting the AC plug, make sure there is no dust or dirt on the terminals.

Engage by pressing the female plug into the splicer (inlet) and the male plug into the wall socket (outlet) until both plugs are fully seated. Incomplete engagement may cause fuming, electric shock or equipment damage and may result in personal injury, death or fire.



Do not short-circuit the terminals of AC adapter (ADC-13) and optional battery (BTR-08). Excessive electrical current may cause personal injury due to fumes, electric shock and equipment damage.





## WARNINGS



Do not touch the splicer, AC power cord and AC plugs with wet hands. This may result in electric shock.



Do not operate splicer near hot objects, in hot temperature environments, in dusty / humid atmospheres or when water-condensation is present on the splicer. This may result in electric shock, splicer malfunction or poor splicing performance.

When using optional battery (BTR-08), follow the instructions below.

Failure to follow these may result in explosion or personal injury.

- Do not charge battery with other methods than instructed.
- Do not discard battery into an incinerator or fire.
- Do not charge or discharge battery near a flame or under direct sunlight.
- Do not excessively shake or jar the battery.



• If battery leaks of liquid residue, be careful handling the battery so the liquid does not get in skin or eye contact. If it reaches contact, immediately wash skin or eyes thoroughly and see the doctor. Dispose of the battery and call the service center for replacement.

- Do not stack battery on top of AC adapter while charging.

• If charge did not complete in three hours or the "CHARGE" LED does not turn ON, immediately stop charging and call the service center for repair.



When transporting the carrying case using the shoulder belt, check the belt and hooks for damage before use. Carrying the case with a damaged shoulder belt may cause the belt to break or come off and result in personal injury or equipment damage.



## CAUTIONS



Do not store splicer in any area where temperature and humidity are extremely high. Possible equipment failure may result.



Do not touch protection sleeve or tube-heater during heating or immediately after completion of heating. Their surfaces are very hot and touching these may result in skin burn.



Do not place the splicer in an unstable or unbalanced position. The splicer may shift or lose balance, causing the unit to fall. Possible personal injury or equipment damage may result.



The splicer is precision adjusted and aligned. Do not allow the unit to receive a strong shock or impact. Possible equipment failure may result. Use supplied carrying case for transportation and storage. The carrying case protects the splicer from damage, moisture, vibration and shock during storage and transportation.

## Warning and Caution



### CAUTIONS

Follow the below listed instructions for handling electrodes.



- Use only specified electrodes.
- Set the new electrodes in the correct position.
- Replace the electrodes as a pair.

Failure to follow the above instructions may cause abnormal arc discharge. It can result in equipment damage or degradation in splicing performance.



Do not use any chemical other than pure alcohol (99% or greater) to clean the objective lens, V-groove, mirror, LCD monitor, etc., of the splicer. Otherwise blurring, discoloration, damage or deterioration may result.



The splicer requires no lubrication. Oil or grease may degrade the splicing performance and damage the splicer.



The equipment must be repaired or adjusted by a qualified technician or engineer. Incorrect repair may cause fire or electric shock. Should any problems arise, please contact your distributor.

### RECYCLING and DISPOSAL

#### In European Union



In accordance with the European Parliament Directive 2002/96/EC, electrical parts and materials that can be re-used and/or recycled have been identified in order that the use of new resources and the amount of waste going for landfill can be minimised.

In the European Union, do not discard this product as unsorted municipal waste. Contact your local authorities.

#### In other countries

##### [Recycling]

To recycle this product, disassemble it first, sort each part separately by material components and follow your local recycling regulations.

##### [Disposal]

This product can be disposed of same as the standard electric products. Follow your local disposal regulations.

The core alignment fusion splicer FSM-60S with technology is designed for splicing many types of fibers. It is small in size and light in weight, making it suitable for any operating environment. It is easy to operate and it splices fast while maintaining low splice loss. In order to achieve the splicer's full capabilities, read the following important information.

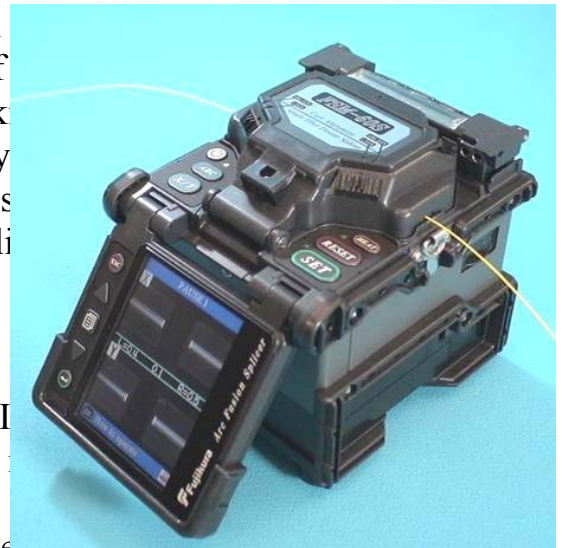

## **Splice mode**

Use [SM] splice mode for standard SM fiber (ITU-T G.652) splicing. It completes in 9 seconds and is the quickest mode for SM fiber splicing.

Use [AUTO] splice mode if fiber type is not identified.

Splice takes longer but it covers most conventional fibers splicing for following reasons.

- (1) [AUTO] mode first identifies fiber type by analyzing fiber profile, and then unique splicing condition is chosen for the type of fiber. The types of fibers covered by [AUTO] are all the conventional fibers, such as SMF (G652), NZDSF (G655), MMF (G651), etc. The [AUTO] modes takes longer for the above processes but is recommended in fiber type is not sure.
- (2) [AUTO] mode comes with automatic arc calibration function, which observes the splicing process and feedback adequate heat power information to the next splice (See next chapter for detail).

## **Automatic arc calibration function**

This function calibrates the arc power at every splice. When the automatic arc calibration function is enabled, performing the [Arc calibration] function before a splice operation is not necessary. The automatic arc calibration function works in AUTO modes only. It doesn't work in the standard splice modes. When using those modes, performing [Arc calibration] before splicing is strongly recommended.

# Introduction

## Environment Performance

To operate by the bad environment, the splicer has improved the performance.

### Dropping

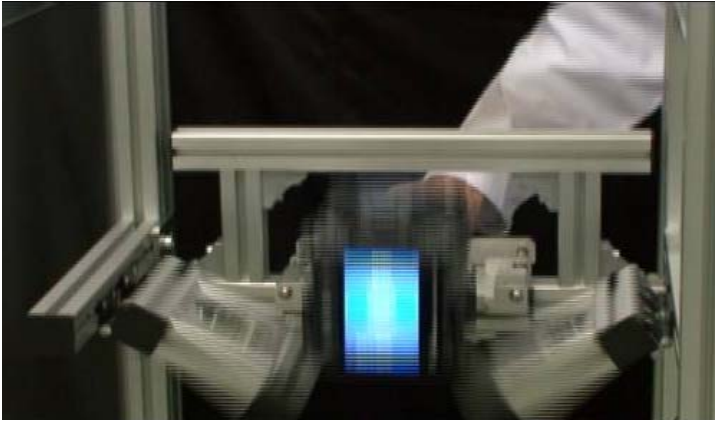

### Water-Proof



### Dust



Fujikura does not guarantee that the splicer will not be damaged under these conditions.

## Unique function

### (1) Automatic change of operating display

The FSM-60S can be operated with monitor in front or at back. The fiber/display image on the monitor automatically turns over depending on the angle of the monitor.



### (2) Sheathe clamping method

Either conventional sheathe clamping system or “fiber holder system (optional)” can be selected. See page 39 for “Stripping and cleaning fiber” and page 40 for “Loading fiber to splicer”.

### (3) The fiber clamp release lever

The fiber clamp arms are attached to wind protector and they close when wind-protector is closed. However, the fiber clamps can be detached by setting “clamp arm release lever” [UNLOCK]. This option can be recommended when fiber has some memory curl, so operator can make sure the fiber is surely clamped before wind-protector is closed.

### (4) Carrying Case with worktable.

The top cover of carrying case can be detached, and used as a work table. See page 26 [How to use the work table on the carrying case].

### (5) Upgrade the software

FSM-60S's software can be upgraded via internet by using “FSM Data Connection” software. Refer to the instruction manual of “FSM Data Connection” software.

### (6) FSM Data Connection software

Splicing condition can be downloaded and splice result is downloaded. In addition, screen image of the monitor can also be downloaded. Refer to the instruction manual of “FSM Data Connection” software for detail.

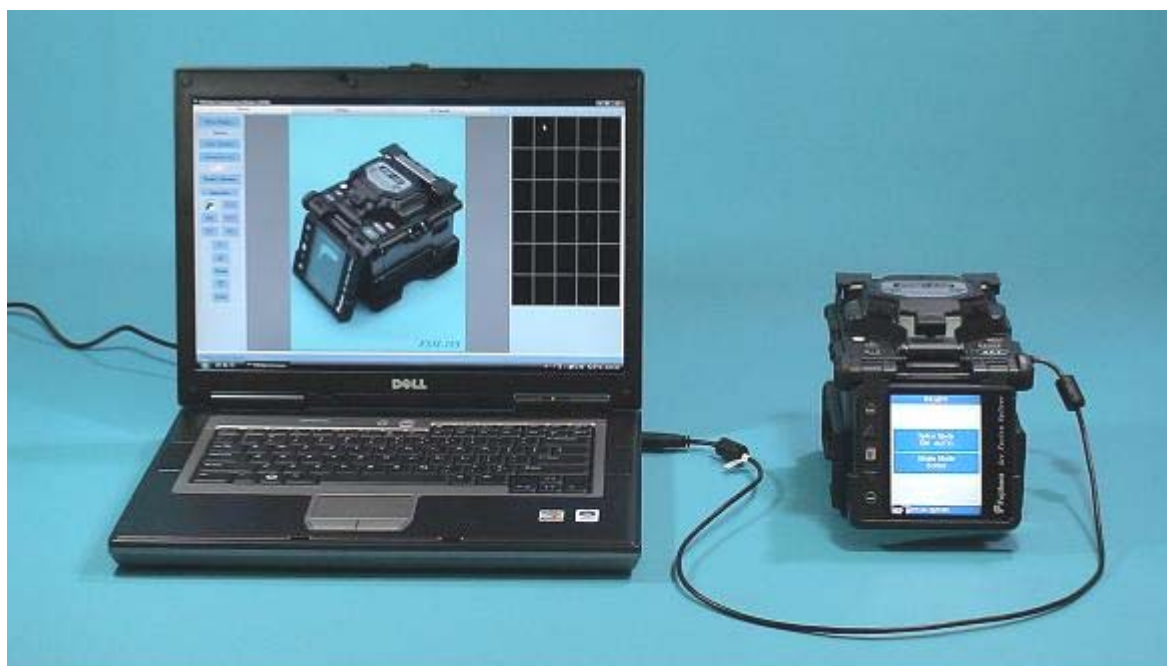

### Notes

#### LCD (Liquid Crystal Display) monitor

The splicer is equipped with a LCD monitor, manufactured in a high quality-controlled factory environment. However, some black dots may appear, or red/blue/green dots may remain on the screen. The screen brightness may not appear uniformly depending on viewing angle. Note that these symptoms are not defects, but are nature of LCD.

# Description of Products

## 1. Components of Splicer STANDARD SET

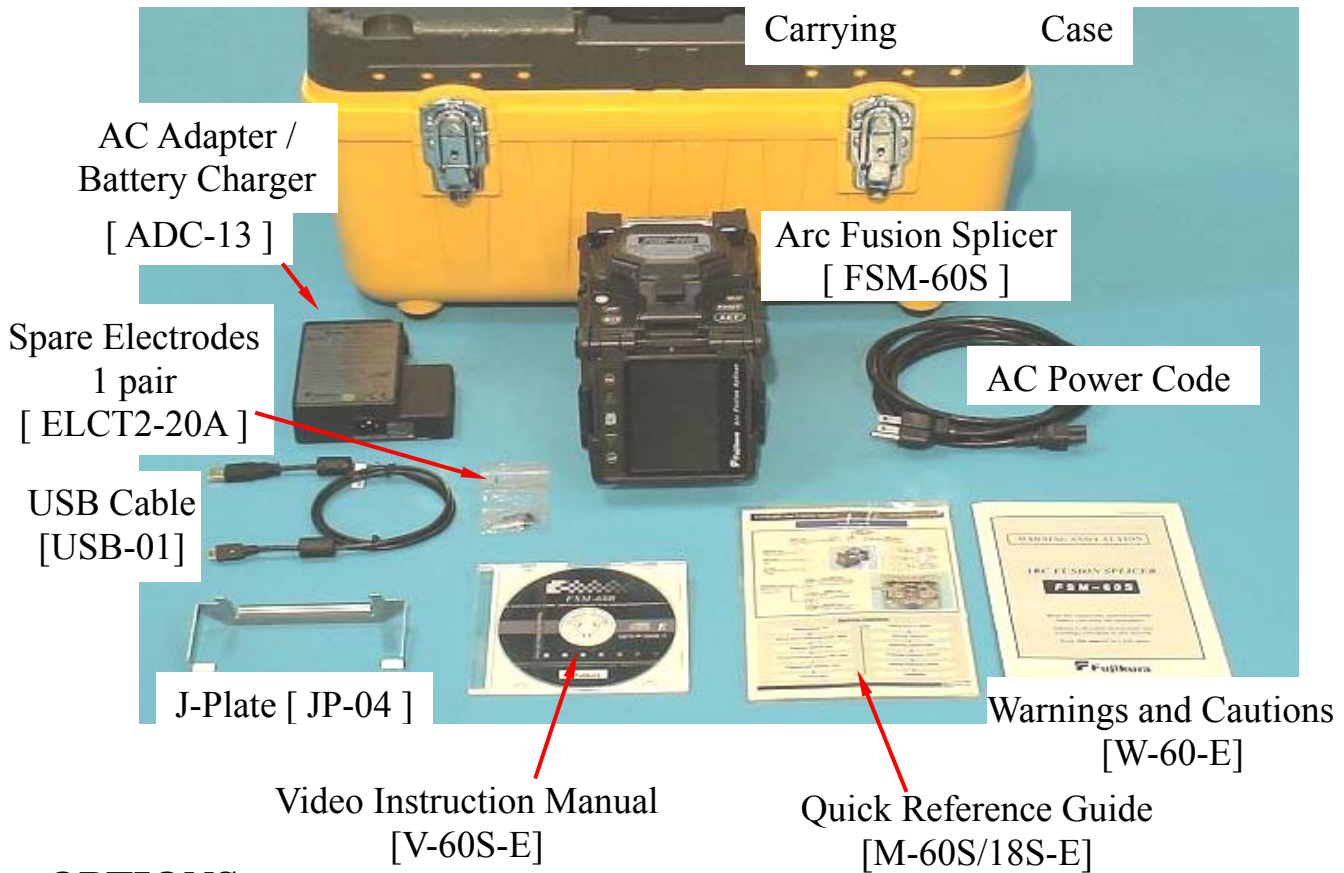

## OPTIONS

### 1. Sheath Clamp

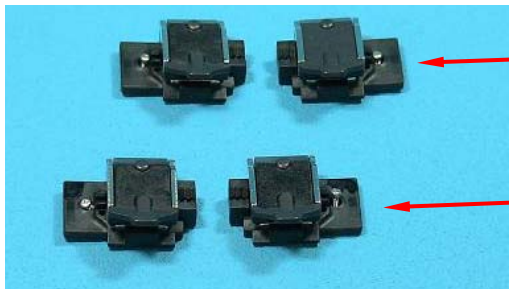

For 900 $\mu$ m, 8mm cleave length [CLAMP-S60B]

For 900 $\mu$ m loose tube fiber [CLAMP-S60C]

\*Note : Standard clamp [CLAMP-S60A]

### 2. Fiber Holder



For 250 $\mu$ m coating [FH-60-250]







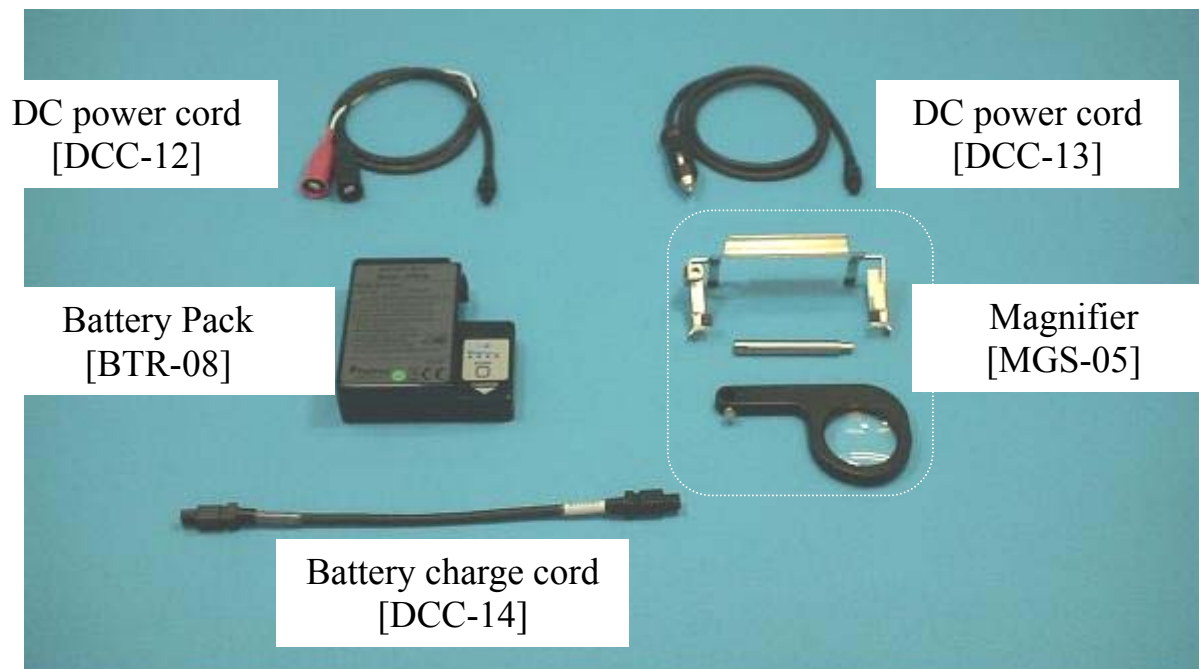

For 900 $\mu$ m coating [FH-60-900]

*3.others*

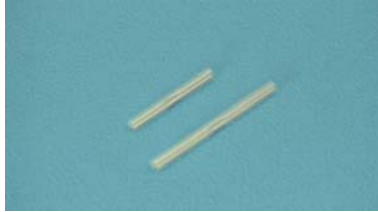

# Description of Products

## 2. Other Necessary Items for Splicing Operation

Fiber coating diameter	0.25mm	0.9mm
Fiber protection sleeves	<u>Standard sleeve</u> 60mm length [ FP-03 ] 40mm length [ FP-03 ( L = 40 ) ]	
	<u>Micro sleeve</u> 20mm length [ FPS01-250-20 ] 25mm length [ FPS01-250-25 ] 34mm length [ FPS01-250-34 ]	<u>Micro sleeve</u> 45mm length [ FPS01-900-45 ]
Fiber stripping tools	Primary coat stripper [ PS-02 ] 	Jacket stripper [ JS-01 ] 
Fiber Holder (Option)	Fiber Holder [FH-60-250] 	Fiber Holder [FH-60-900] 
Fiber cleaving tools	Fiber Cleaver [CT-30] 	
	<u>Fiber Plate [ AD-30B ]</u> Cleave length : 16mm fixed <u>Fiber Plate [ AD-30A ]</u> Cleave length : 6 to 20mm	<u>Fiber Plate [ AD-30B ]</u> Cleave length : 16mm fixed <u>Fiber Plate [ AD-30A ]</u> Cleave length : 10 to 20mm
Fiber cleaning tools	Alcohol dispenser with alcohol (purity > 99% ) Lint-free tissue or gauze	



Blank Page

## *Description of Products*

### *3. Description and Function of Splicer*

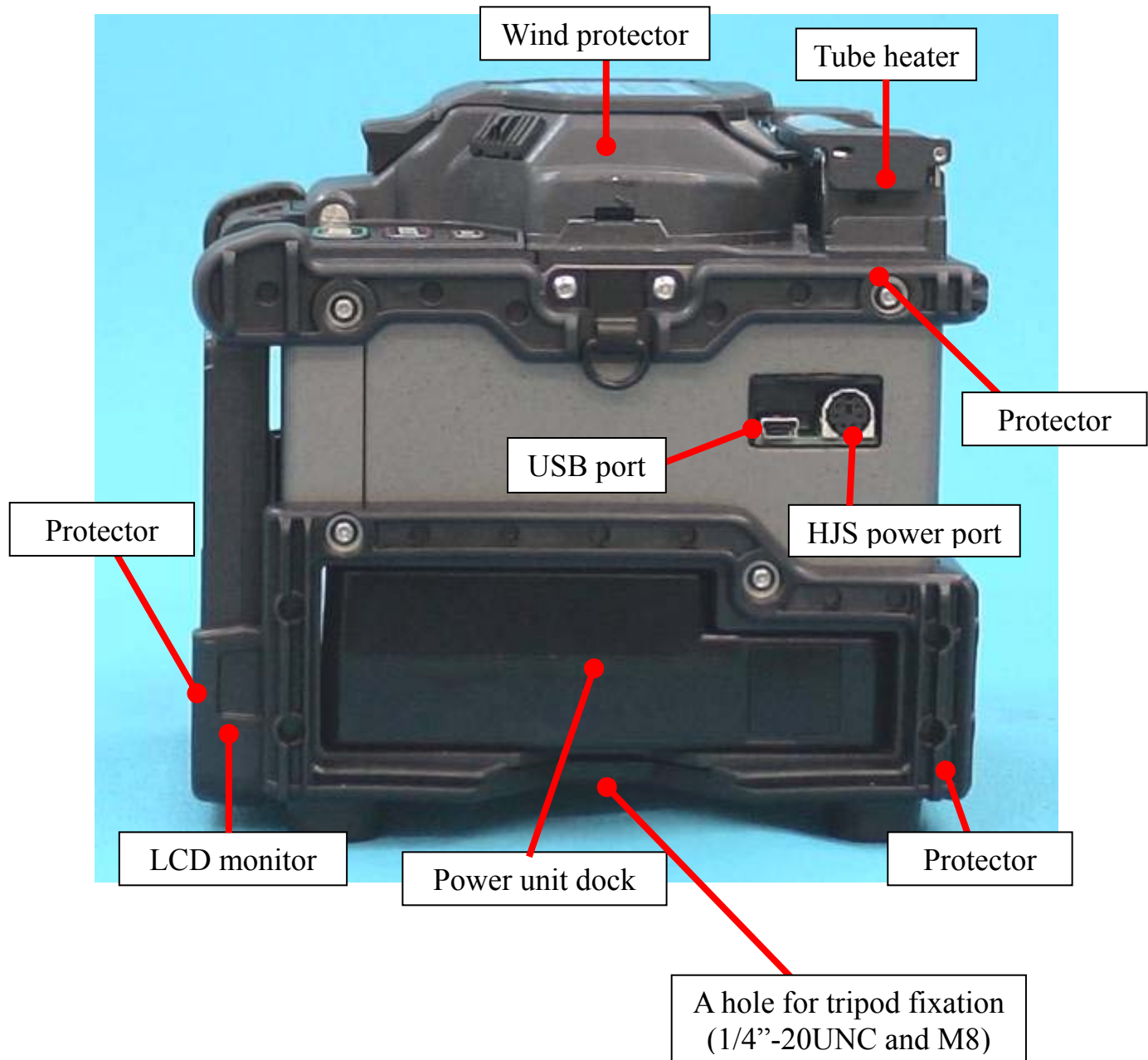

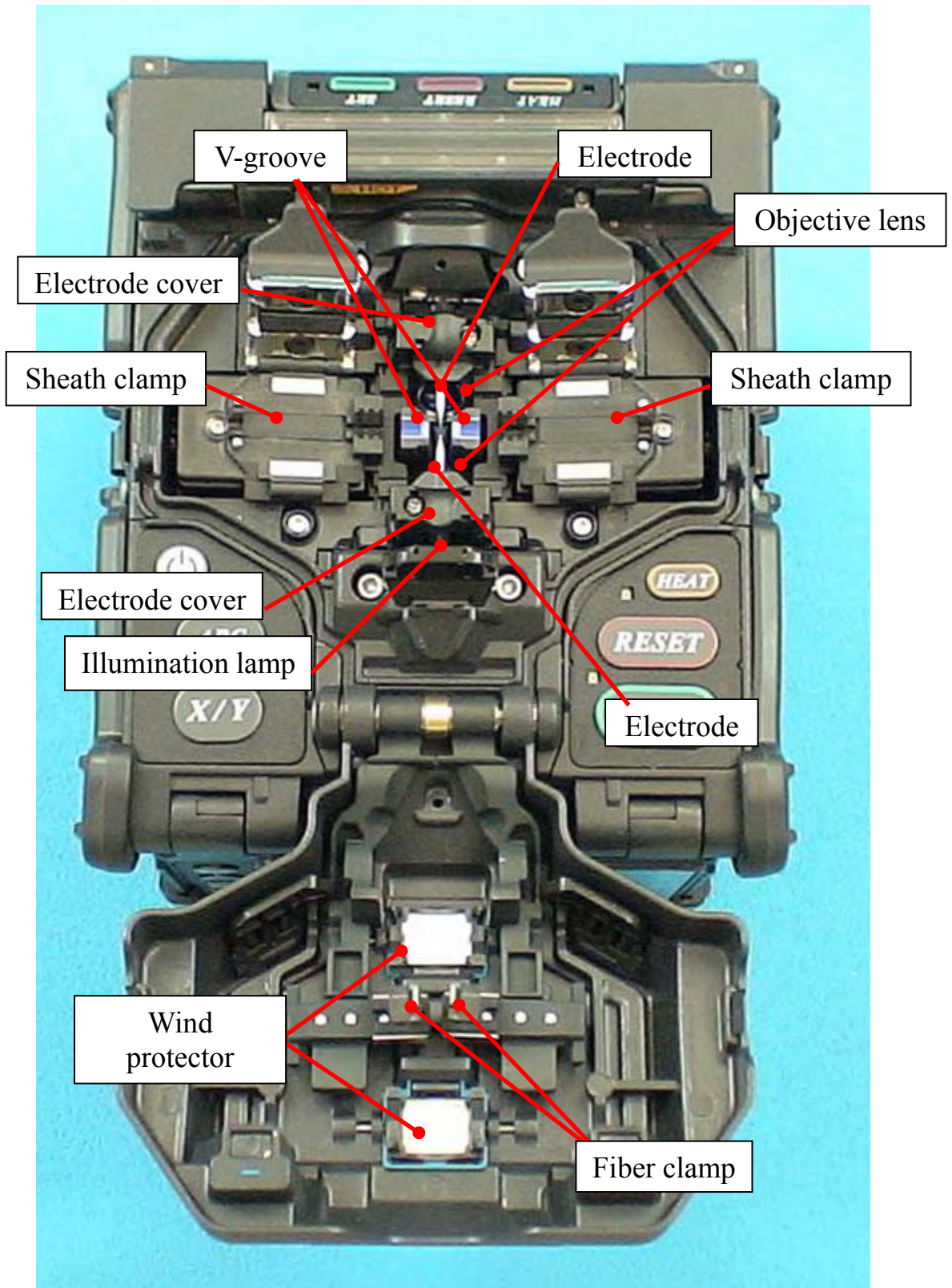

# Description of Products

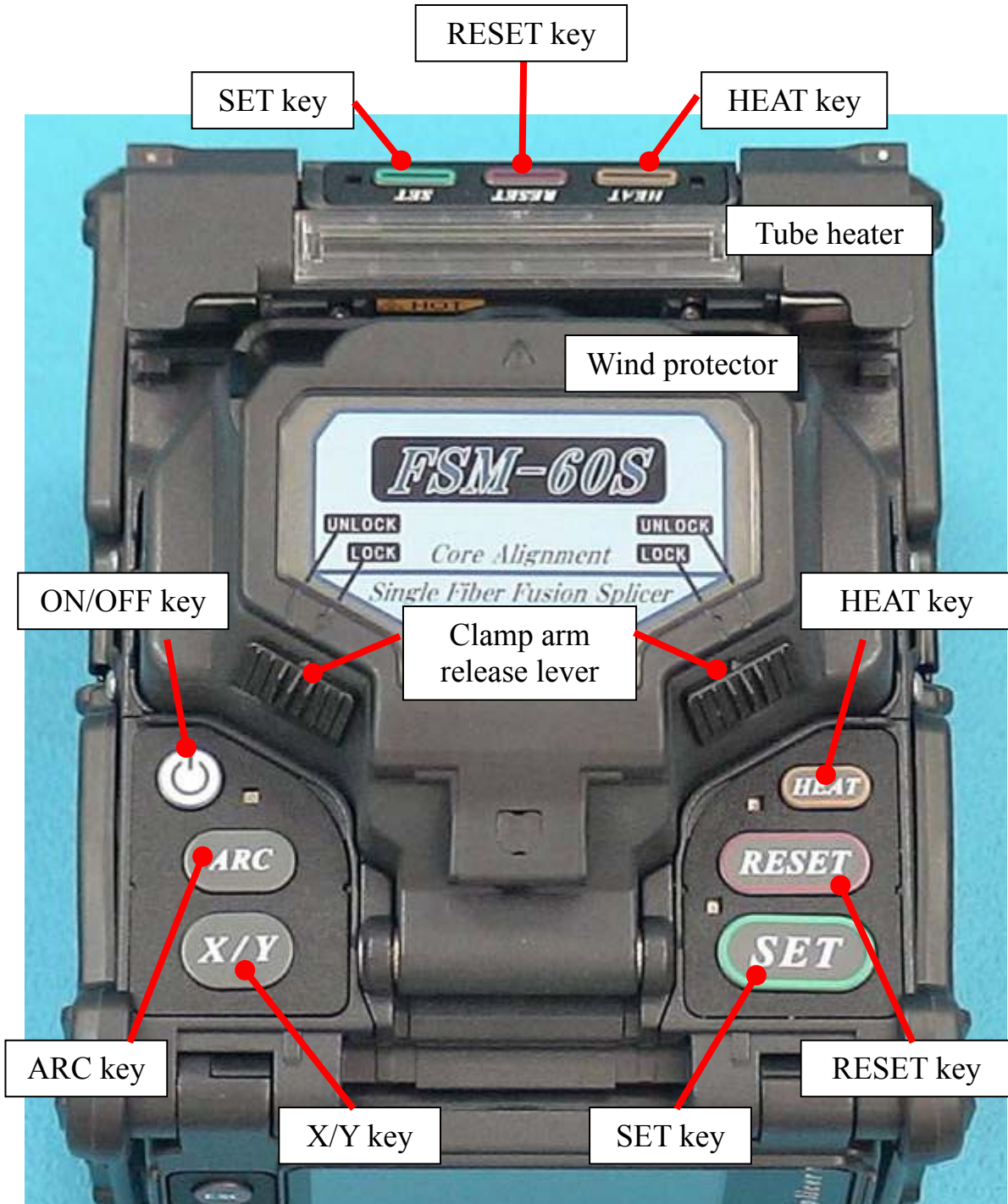



# *Point of the splice procedure*

## **1. To get a stable low splice loss**

### **1-1. Daily cleaning before Splicing Operation**

- Clean the V-grooves.

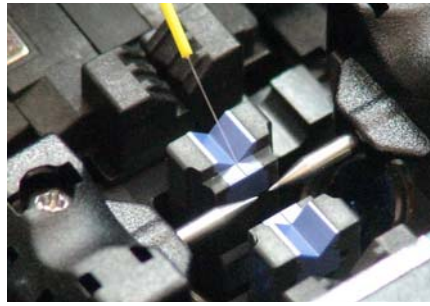
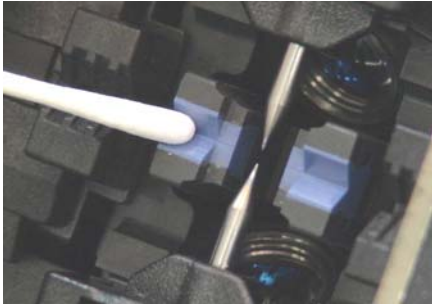

- Clean the wind protector mirrors.



- Clean the Clamp Chips.



- Clean Objective Lens every week, or when it's dirty.

In this case electrodes do not remove from the splicer.

 • Do not touch or hit electrode tips.



### ***1-2. Select / use the suitable splice mode***

How to select the “Splice Mode”

- When splicing only standard SM fibers (ITU-T G.652), “SM AUTO” mode is recommended.
- When splicing many types of fibers, “AUTO” mode is recommended, but splice speed is slow.
- Splicing speed of “SM FAST” mode is fast, but periodical Arc calibration is required.

### ***1-3. Cleaning the equipment before every splicing***

- Clean the blade of stripper.
- Clean the cleaver pads and blade and rubber anvil.

### ***1-4. Splicing Procedure***

- Make sure the stripped fiber is free of coating debris or contamination.
- Use only 99% or better purity alcohol.

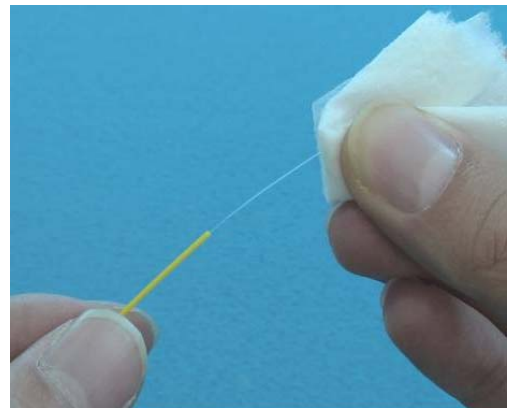

- Do not allow the cleaved fiber ends to touch anything or become contaminated.
- Place the fiber end between V-groove edge and Electrode center.

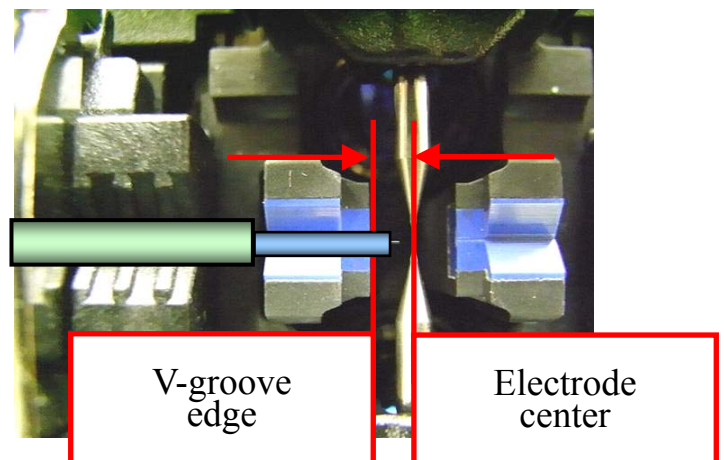

## *Point of the splice procedure*

- Place fiber in the bottom of V-groove for successful splicing.

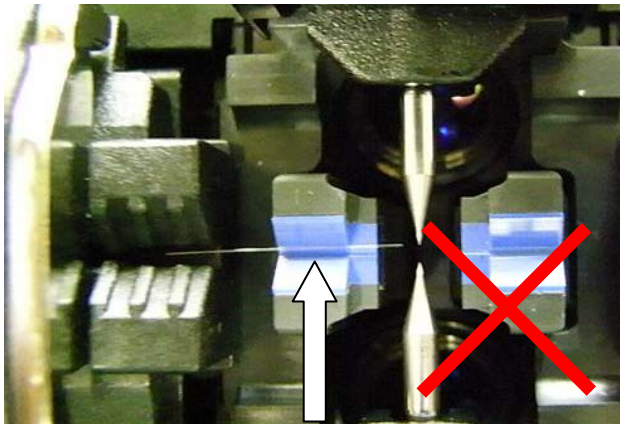

No Good

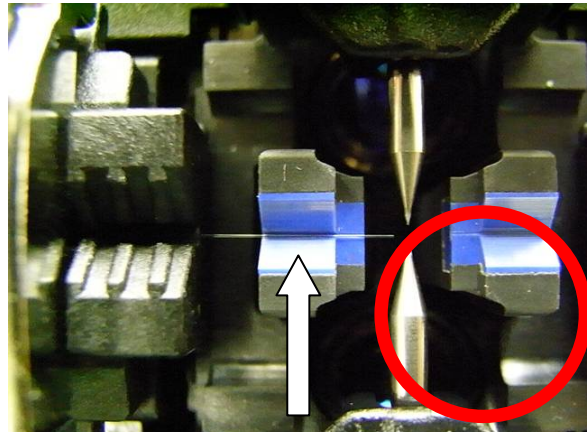

Good

- Make sure if the cleave length is correct. Fiber coating edge may hit the V-groove in case with shorter cleave length, and then the fibers may not be stuffed each other during arc discharge and result in worse splice loss.

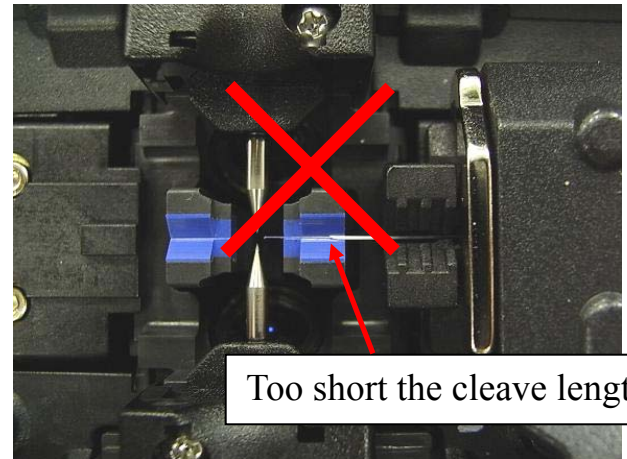

- Do not put tension to the fibers, or the fibers may not be stuffed each other during arc discharge and result in worse splice loss.

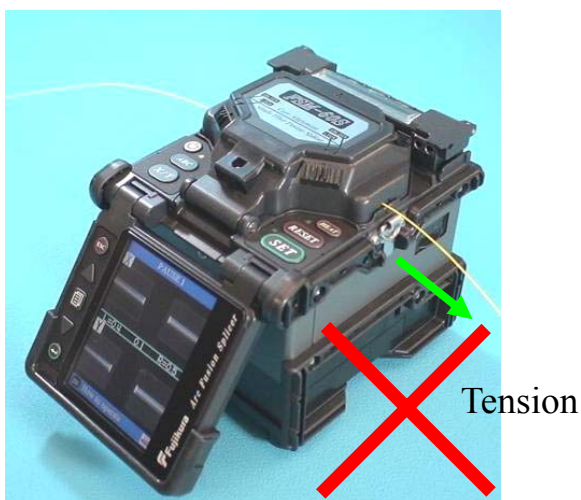



## Point of the splice procedure

- Check the fiber angle and cleave shape. The fiber cleave angle affects splicing quality. Large cleave angle worsens splice loss.

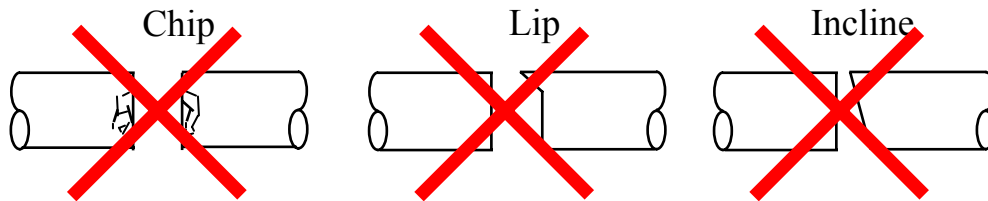

- Visually check the arc discharge with the monitor. In case the arc discharge is observed “wobbling” or “brightness changes”, arc discharge may be unstable and the heat distribution to the fibers as well resulting in worsened splice loss. Perform “Stabilize Electrodes”

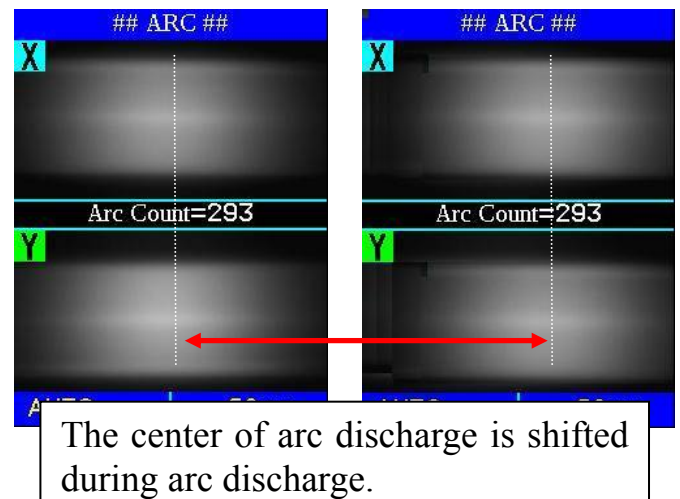
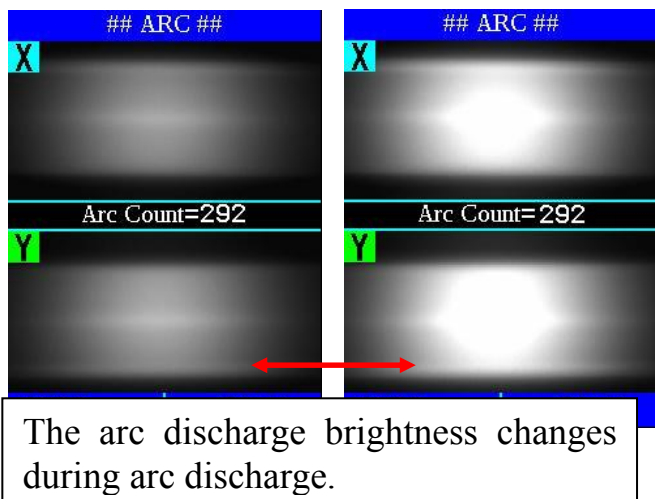

- **When splicer indicates following message, splice loss may be high.**

**“Arc discharge is not stable. Electrodes should be stabilized to reform the arc discharge.”**

**Load prepared SM fibers onto splicer in order to stabilize electrodes. After completing it, re-splice fibers.**

## *Point of the splice procedure*

### Heating

- Select the heater mode most suitable for the protection sleeve to be used.  
Each tube-heating mode is optimized for a type of Fujikura protection sleeve.  
Other manufacture's fiber protection sleeve may not shrink completely.  
At that time extend the heating time. See page 80 [Heater Mode].
- Centering protection sleeve in tube heater

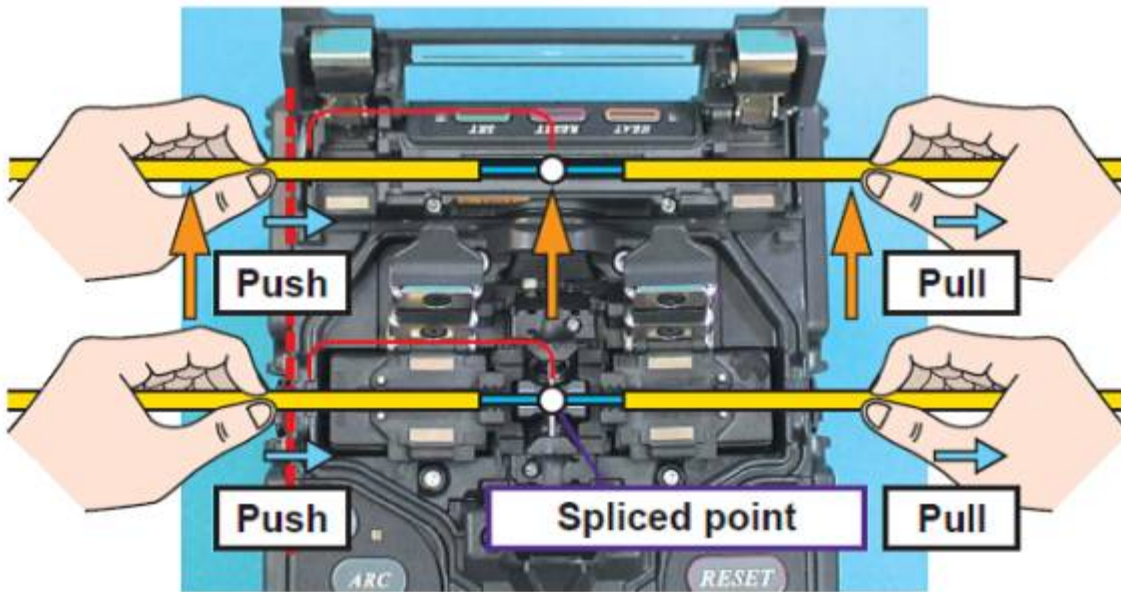

### **2. Power Supply**

Use only supplied AC power cord.

Connect to ground with ground terminal of AC power cord.

#### **2-1. To prevent the damage of AC adapter**

AC generators may produce abnormally high AC output voltage or irregular frequencies. Such abnormally high voltage or frequency from a generator may cause fuming, electric shock or equipment damage and may result in personal injury, death or fire. Measure the output AC voltage with a circuit tester before connecting the AC power cord. In addition, make also sure that the generator is regularly serviced.



Check the voltage before connecting  
the AC power code

#### **2-2. Battery**

(1) The capacity of the battery gradually decreases as nature even if it is not used. If the battery discharges completely, the battery may no longer be able to be re-charged. Charge the battery before long time storage and after use.

(2) If a battery is to be stored for a long time, periodical charge of every six months is recommended regardless of battery charge level of the battery.

(3) Follow below conditions for operation/charge/long time storage (1 week or longer).

Operation : -10 degree C ~ 50 degree C

Charge : 0 degree C ~ 40 degree C

Long Time Storage : -20 degree C ~ 30 degree C

# Basic Operation

## 1. How to use the work table on the carrying case

The worktable can be attached / detached to the carrying case.



• The splicer can not be attached to the work table without protector.

(1) Detach the work table from the carrying case by loosen the screw.

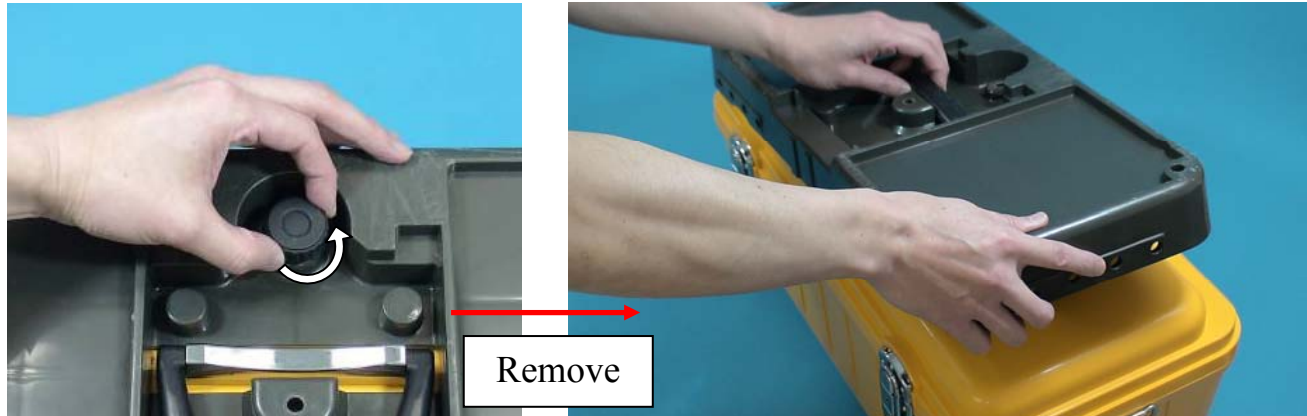

(2) Tighten the screw behind the worktable to fix the splicer.

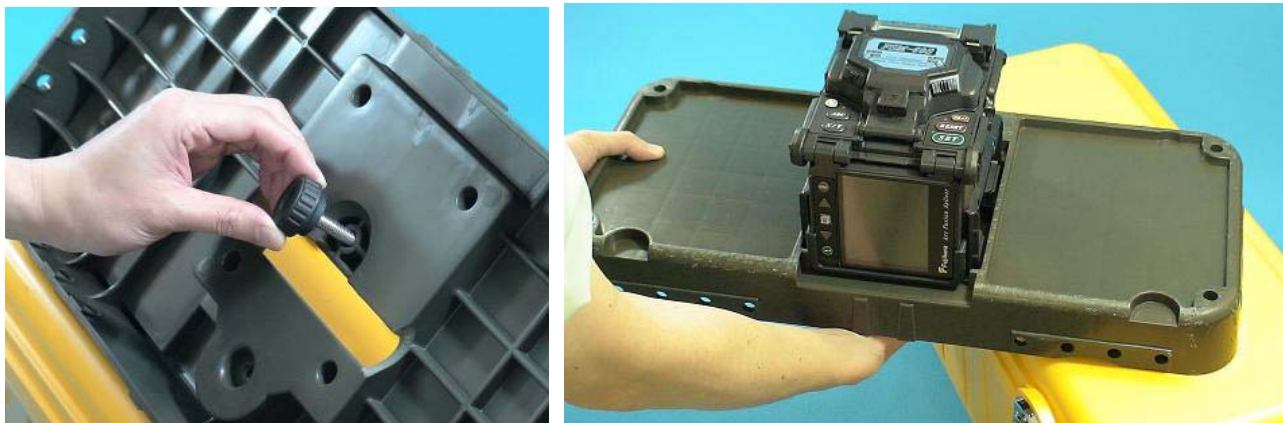

(3) Place necessary items for splicing operation on the table.



- (4) Holes on the worktable can be used to create your original work tray suitable for your unique splicing style.

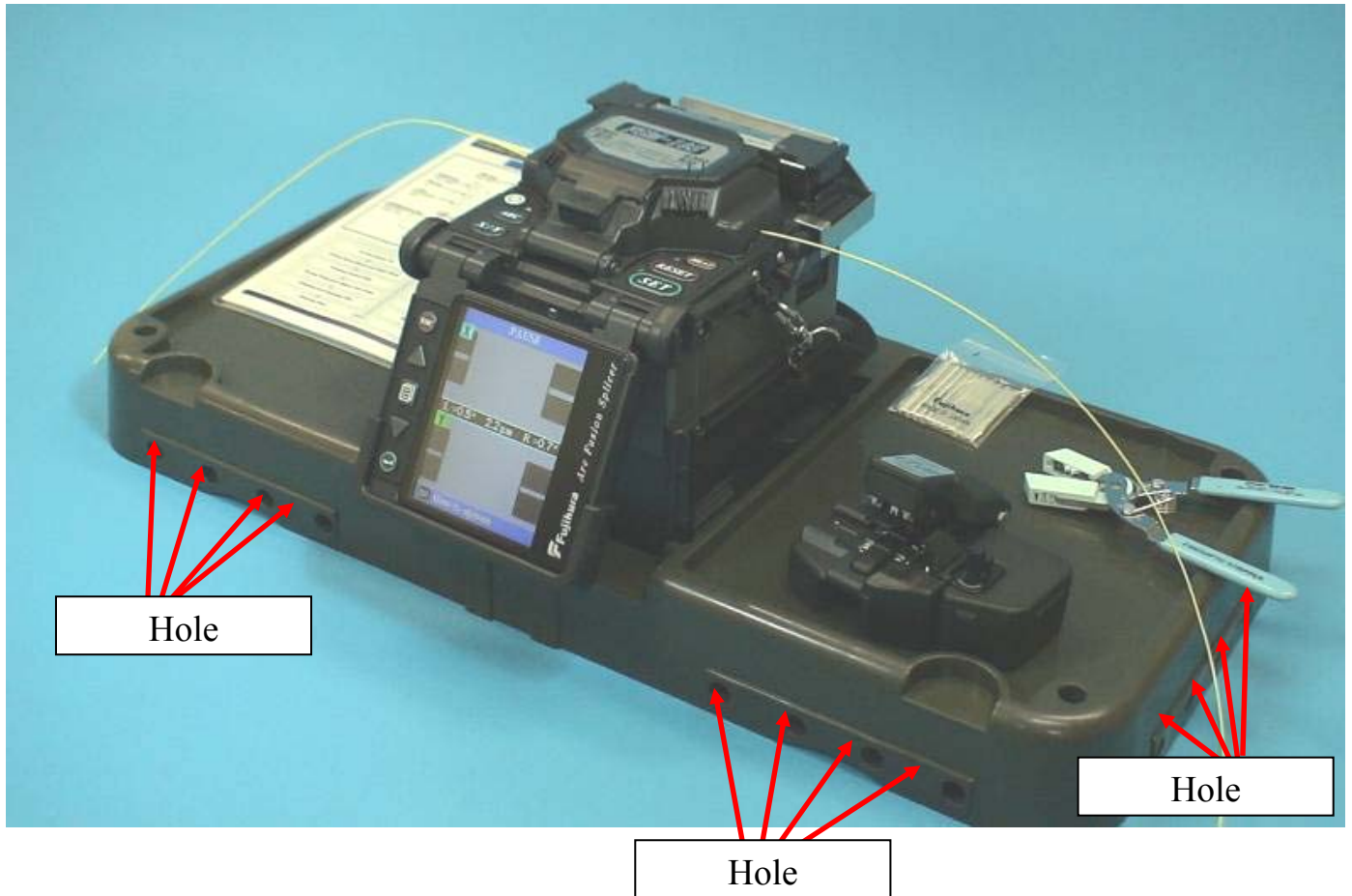

-  Arrange safety belts/devices for equipments and accessories on the tray before use. Straps for small accessories may be recommended. In case the equipment/accessories were dropped to a person under operation area, this would result in serious injury or fatal accident.

# Basic Operation

## 2. Inserting Power Supply to Splicer

For AC operation or DC operation with external battery, use AC adapter (ADC-13). For battery operation, use detachable battery (BTR-08). The Power Unit Dock, located on the splicer body, can accommodate both power supplies (ADC-13 and BTR-08).

### 2-1. Inserting or detaching power unit

#### Inserting power supply unit

Insert power unit into Power unit dock until it clicks into place.

#### Detaching power supply unit.

Turn off the splicer before removing the power supply unit. Press the release button, located on the side of the splicer body, and remove the unit from the other side of the release button.



### 2-2. AC Operation

Plug the supplied AC cord into the AC inlet of the AC adapter. The power ON LED in the AC adapter turns green (green color) when suitable AC voltage is supplied. If high AC Voltage is supplied, the AC adapter will be immediately damaged.

AC generators commonly produce abnormally high output voltage or irregular frequencies. Measure the output AC voltage with a circuit tester before connecting the AC power cord.

Such abnormally high voltage or frequency from a generator may cause fuming, electric shock or equipment damage and may result in personal injury, death or fire. Make sure the generator is regularly checked and serviced.

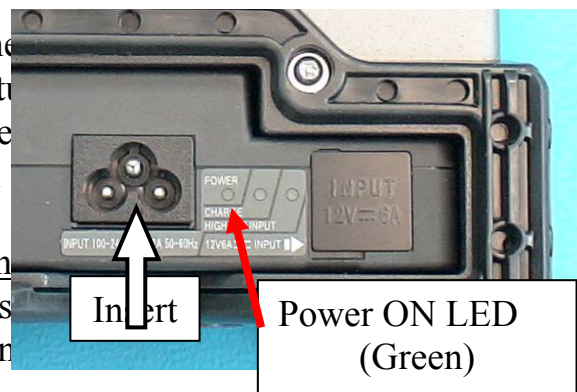

## 2-3. DC operation with external battery

Open shutter for DC inlet of AC adapter.



Do not supply DC16V or greater, the AC adapter will be damaged immediately.

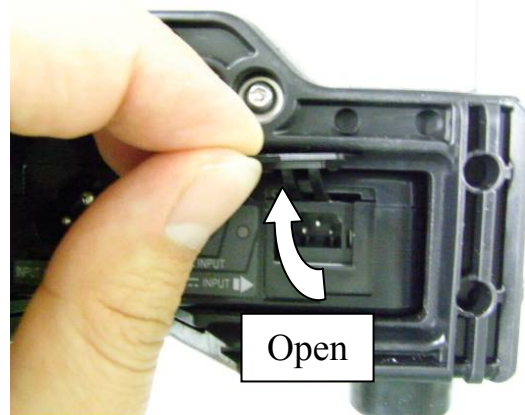

Plug DC cord (DCC-12 or DCC-13) into DC inlet of AC adapter. The ON LED turns on (green color) when suitable DC voltage is supplied. In case DC16V or greater is supplied, or polarity (positive / negative) is wrong, The AC adapter protection circuit shuts down the DC output and DC Warning LED [HIGH ~ INPUT] turns on (red color).

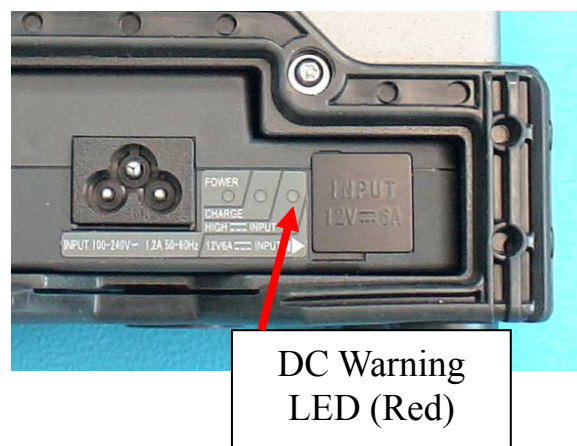
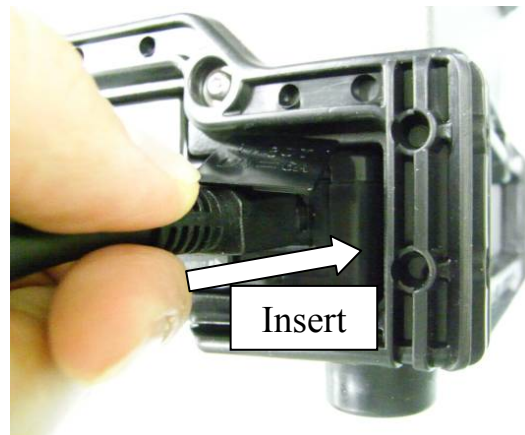

# Basic Operation

## 2-4. Battery operation

Check and make sure the remaining battery capacity is 20% or greater before operation otherwise few splices can be made.

- Fully discharge battery at least every three months, or the battery degrades due to memory effect. See page 95 for [Battery Discharge].



Keep below practices to prevent battery damage.

1. Fully charge the battery after every use.
2. Follow below conditions.

Operation	: -10 degree C ~ 50 degree C
Charging	: -10 degree C ~ 40 degree C
Storage	: -20 degree C ~ 30 degree C

### How to check remaining battery capacity

- If battery is already inserted in the splicer, turn splicer ON. Power source of "Battery" is automatically identified and the remaining battery capacity is displayed on the "READY" screen.
- If battery is not inserting in the splicer, simply press the battery check button (1) on the battery pack. The remaining battery capacity is indicated on the LED indicator (2). Just after turning splicer ON. If battery capacity is not enough to do operation, splicer warn the message appear in the LCD monitor. Then execute "Battery Discharge" in maintenance menu. After discharge, recharge battery.





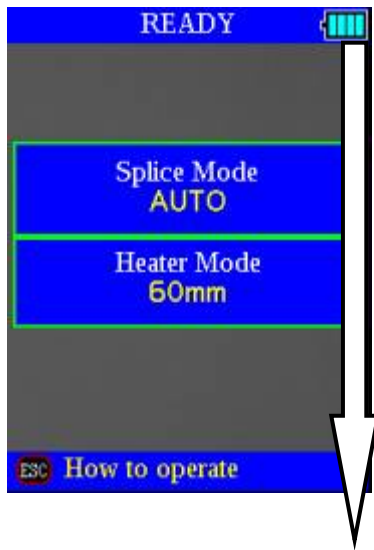



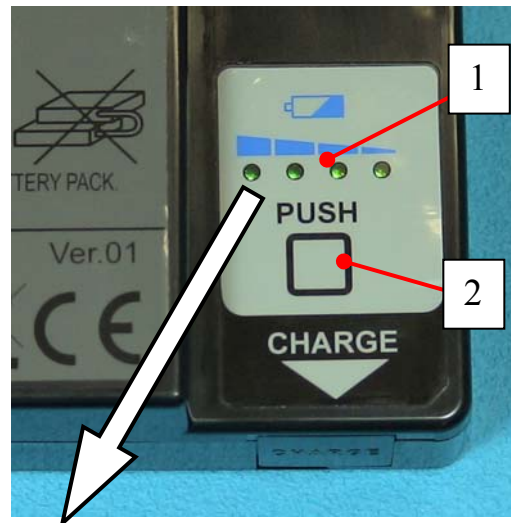

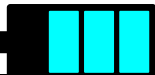

READY screen



Remaining battery capacity indicator



Remaining battery capacity display	Remaining battery capacity indicator	Remaining battery
(Blue Color) 	 4 LED	75~100%
(Blue Color) 	 3 LED	50~75%
(Yellow Color) 	 2 LED	25~50%
(Red Color) 	 1 LED	10~25%
(Red Color) 	 1 LED Flashing	Less than 10%

# Basic Operation

## How to charge battery

Open shutter for battery charge plug inlet of the Battery Pack. Plug the supplied battery charge cord (DCC-14) into both the battery charge inlet of the AC adaptor (ADC-13) and the battery charge terminal located on the battery pack (BTR-08) side. The CHARGE LED turns on (orange color) and battery charging begins. Battery charge is completed in approximately five hours. After completion, disconnect the AC cord, and then charge cord.

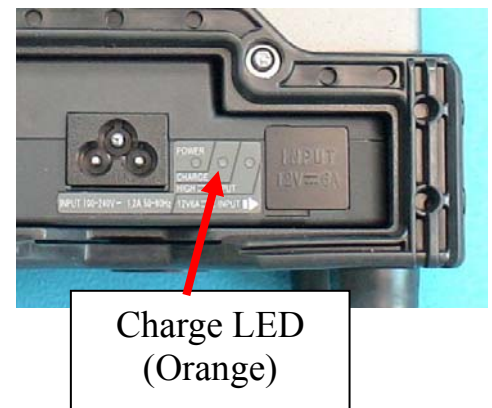
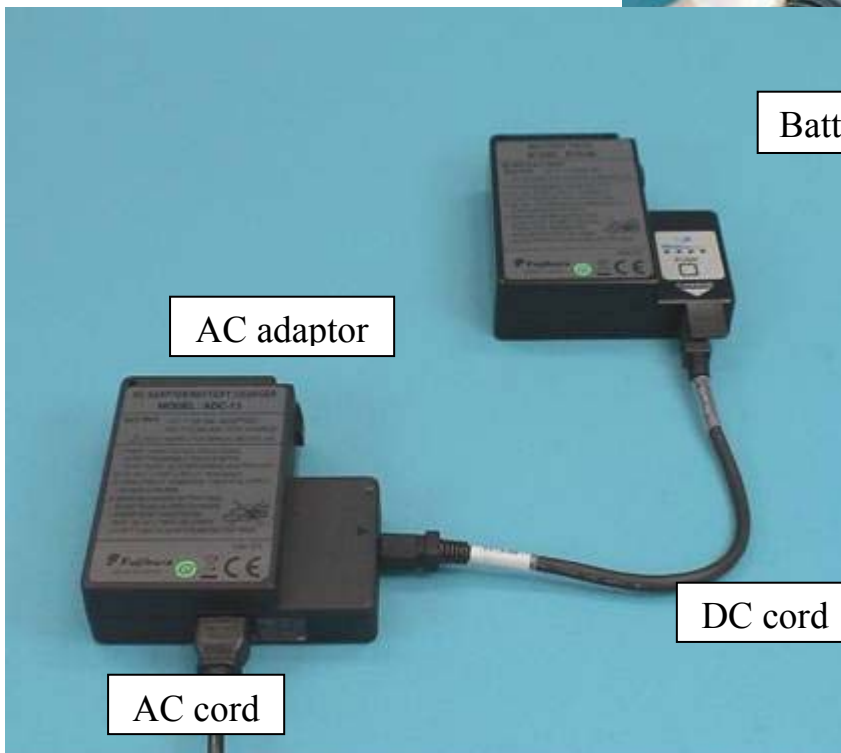
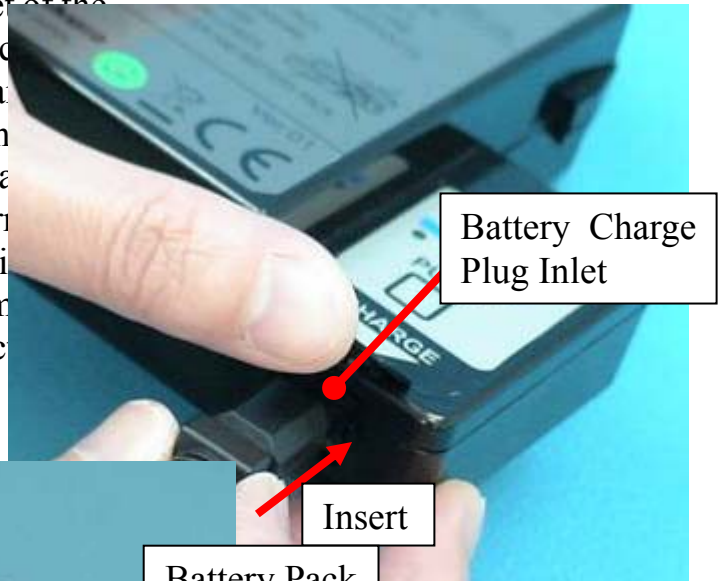

•The battery packing can be charged also with AC and DC.

- Do not place battery on top of AC adapter or vise-versa.
- Battery can be charged while AC adapter (ADC-13) is in power unit dock of FSM-60S regardless of under operation or not.
- 💡 • CHARGE LED turns off when battery charge is completed. If CHARGE LED flashes, replace the battery with a new one.
- If battery charge does not complete in five hours or CHARGE LED does not turn ON, the battery, AC adapter or both need replacement. Ask your service agent for further instruction.

# Basic Operation

## 3. Turning splicer "ON"

Press **ON/OFF** key and hold it until the green LED on. The following warning screen is displayed.



- It is displayed in 3 per 1 month when turn the splicer power on.
- There is the case that a language is fixed depending on the country of shipment.

The READY screen is displayed after all the motors are reset to their initial positions when you select [Agree]. The power source type is then identified. If the battery is used, the remaining battery capacity is displayed.

### Monitor Angle

Adjust the monitor angle so that screen is viewed clearly.



## Monitor brightness

Monitor visibility changes depending on environmental conditions. To change monitor brightness, press **Up/Down** Arrow key to change value and press **Enter** key to set value.

## Splice Mode

Select appropriate splicing mode for the specific fiber combination. Current mode is displayed on the READY screen.



- AUTO mode is recommended for splicing SM, DS, NZDS and MM fibers. Arc calibration is automatically performed for consistent splicing performance.

## Heat Mode

Select appropriate heating mode for the specific protection sleeve used. Current mode is displayed on the READY screen.

READY



**UP/DOWN**  
Arrow key

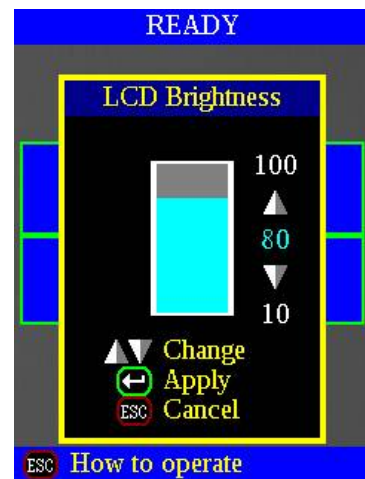

**Enter** key

Decided

## Basic Operation

### 4. Cleaning optical fiber

Clean optical fiber with alcohol-impregnated gauze or lint-free tissue approximately 100mm from the tip. Dust particulates from the fiber coating surface can enter inside the protection sleeve and might result in a future fiber break or attenuation increase.

### 5. Placing protection sleeve over fiber

Place the protection sleeve over the fiber

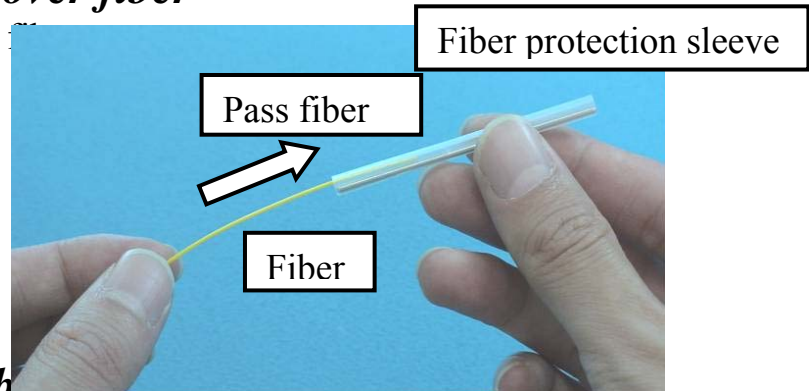

### 6. Stripping and cleaning fiber

#### 6-1. Sheath Clamp

Strip outer coating 30 to 40 mm from its tip with a stripping tool. Clean the fiber with alcohol impregnated gauze or lint-free tissue thoroughly. Use fresh gauze or wipe only. Do not use gauze or wipe twice.

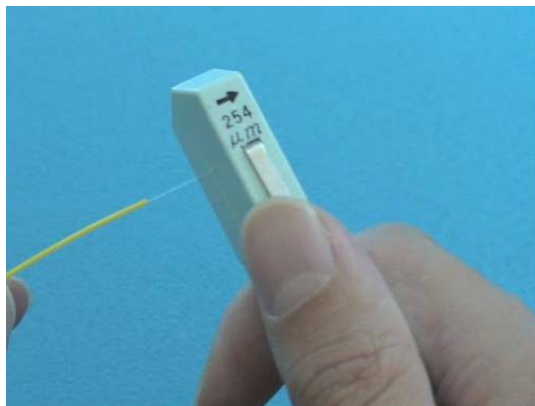

Stripping

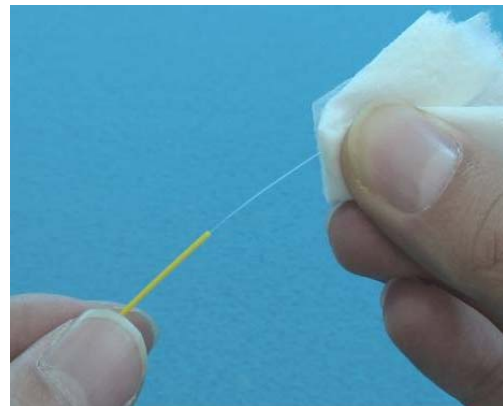

Cleaning



• Use a high quality alcohol, greater than 99% pure.

## 6-2. Fiber holder System

(1) Set the fiber onto the fiber holder with the fiber protruding 30 to 40mm from the end of the fiber holder and then close the fiber holder lid.

- Close the lid of a fiber holder while pressing down with a finger on the coating (refer to figure below).
- Select a suitable fiber holder based on the fiber coating diameter.
- If fiber coating has some memory curl, place fiber so that the curve of memory is turned upwards.

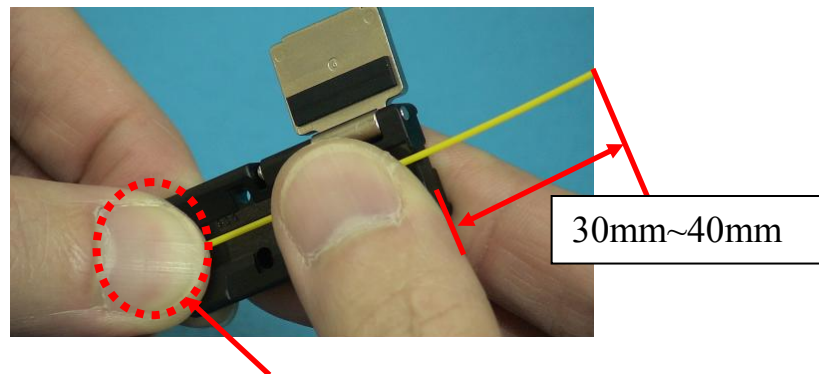

Pressing down with a finger

(2) Strip the sheath by tool from the fiber.

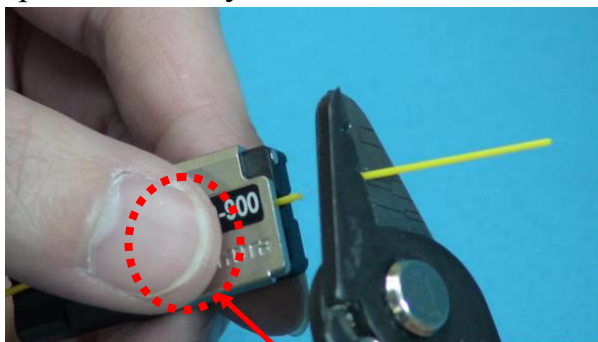

Pressing down with a finger strongly

### Notes

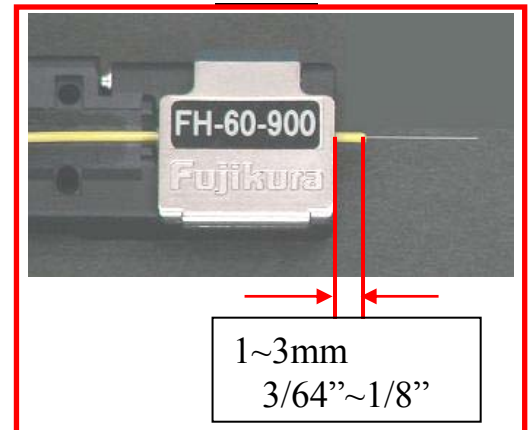

(3) Clean the bare part of the fiber with alcohol-impregnated gauze or lint-free tissue.

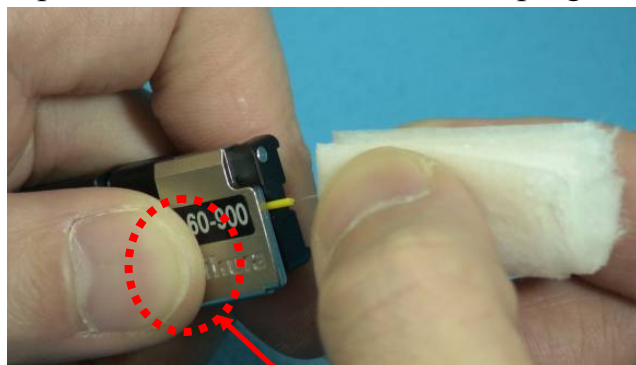

Pressing down with a finger strongly

# Basic Operation

## 7. Fiber Cleaving

(1) To unlock the cutting lever, press it gently and slide the stopper.



(2) Push the slide button until it locks.

(3) Set the stripped optical fiber on the cleaver.



- Confirm the sheath of fiber is not on pad when fiber holder is used.

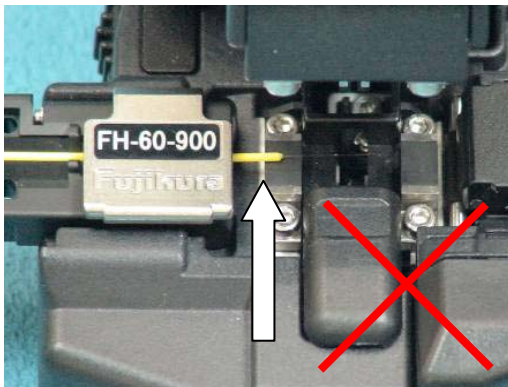

No Good

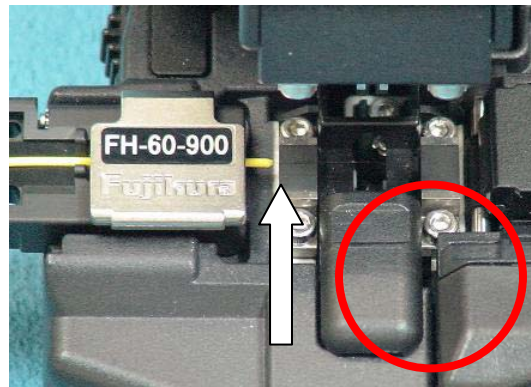

Good

(4) Press down the cutting lever.

(5) Release the pressure on the cutting lever. A spring force will bring it to its open position.

(6) The scrap collector rollers drive the fiber scrap into the fiber scrap container box automatically when the cutting lever is raised.



- Do not put fingers in the driving area of the slide button as personal injury may result.
- After pressing it half way down, releasing the pressure on the cutting lever may result in bad cleaving quality.
- Discard the fiber scrap container box contents frequently.
- If using the CT-30A, align the end of the fiber coating to the position on the graduated scale for the desired cleave length.



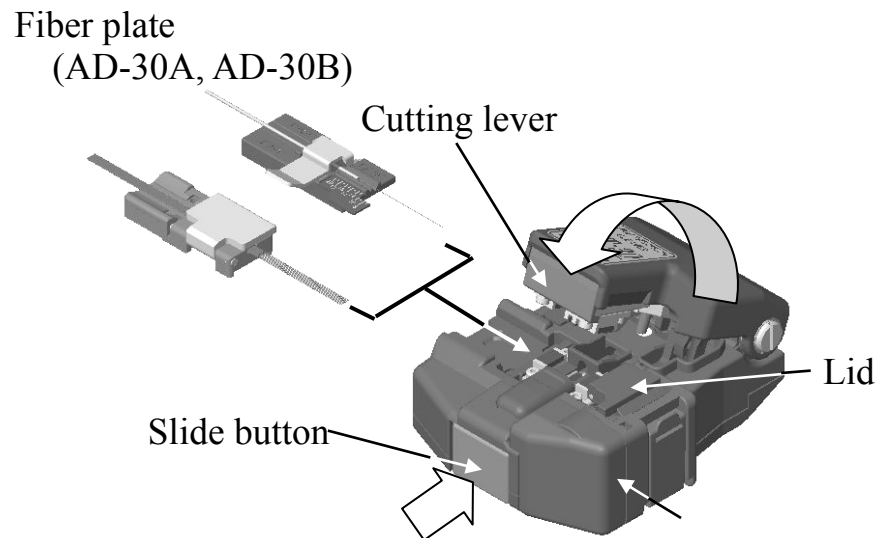

(7) Close cutting lever completely then set stopper to lock the cutting lever closed.

# Basic Operation

## 8. Loading fiber to splicer

### 8-1. Sheath Clamp

- (1) Open wind protector and sheath clamps.
- (2) Place prepared fiber onto v-groove so that fiber tip is located between the v-groove edge and tip of electrode.

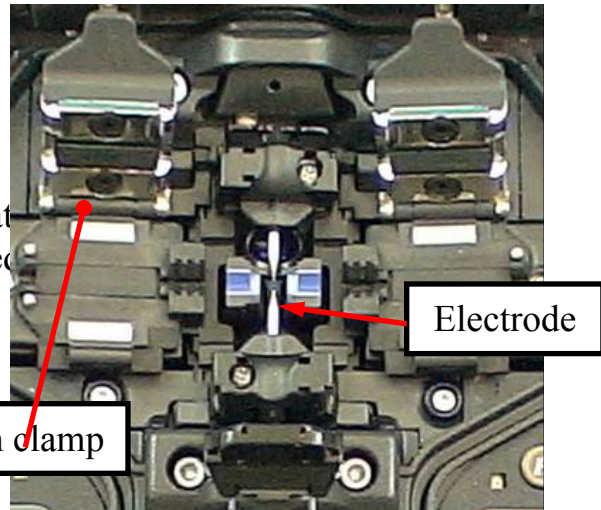

- If fiber coating has some memory curl, place fiber so that the curve of memory is turned upwards.
- Be careful to not bump the prepared fiber tips into anything to maintain fiber end-face quality.

- (3) Hold fiber with fingers and close sheath clamps so that the fiber does not move. Make sure fiber is placed in the bottom of the v-groove. If fiber is not placed properly, reload fiber.
- (4) Load another fiber in the same manner as (3) above.
- (5) Close wind protector. The splicer starts the procedure automatically.

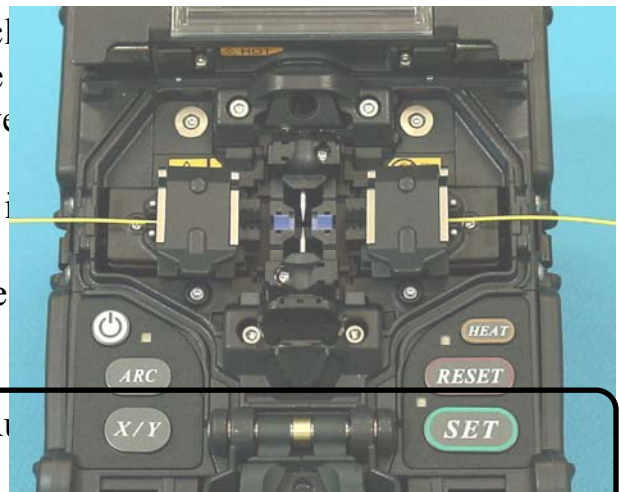

To disable the “Auto Start” function, set [Auto Start] to OFF. See page 58 [Splice Menu].

## 8-2. Fiber Holder System

(1) Loosen a screw beside sheathe clamps and take sheathe clamps off the splicer.

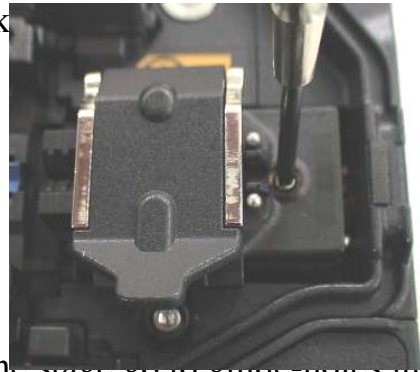

(2) Open the wind protector.

(3) Place fiber holders so that the guide pins on the stage go to guide holes in the fiber.

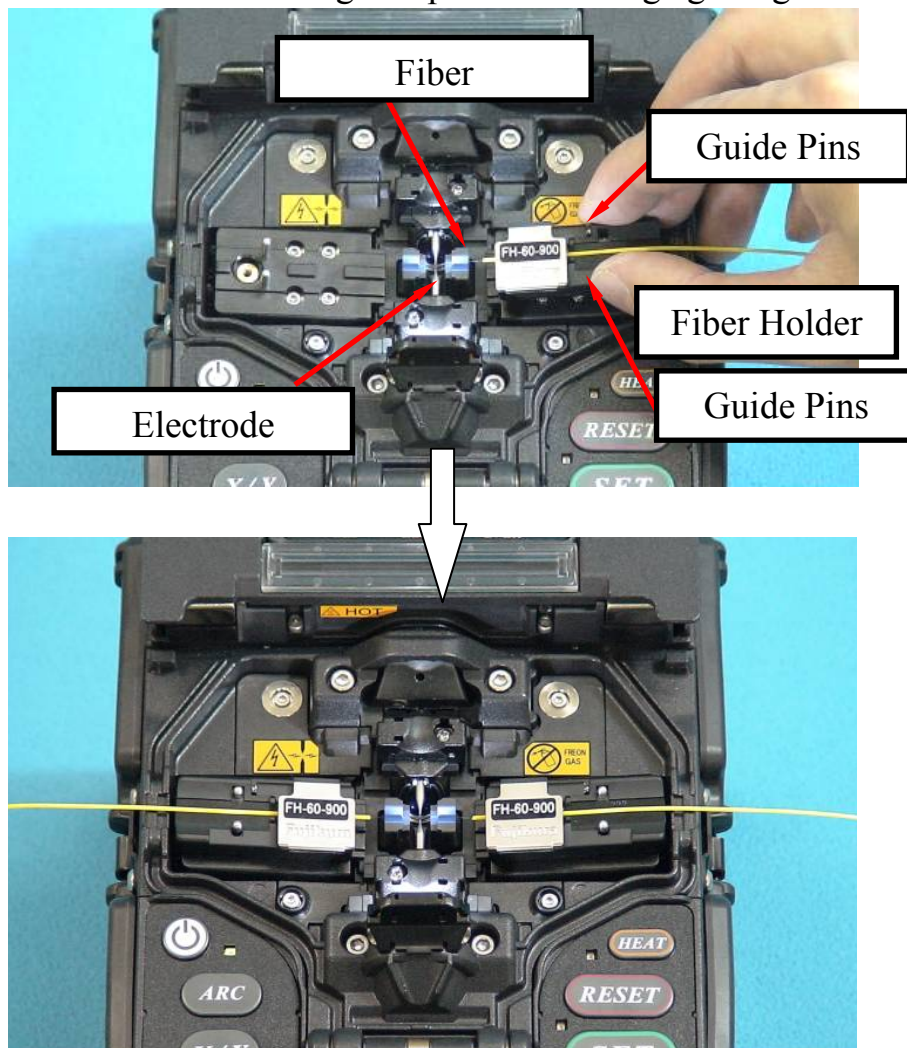

• Be careful to not bump the prepared fiber tips into anything to maintain fiber end-face quality.

(4) Close wind protector. The splicer starts the splice procedure automatically.

## Basic Operation

### The fiber clamp release lever

The fiber clamp arms are attached to wind protector and they close when wind-protector is closed. However, the fiber clamps can be detached by setting “clamp arm release lever” [UNLOCK], then the fiber clamp can be moved independently. This option can be recommended when fiber has some memory curl, so operator can make sure the fiber is surely clamped before wind-protector is closed.

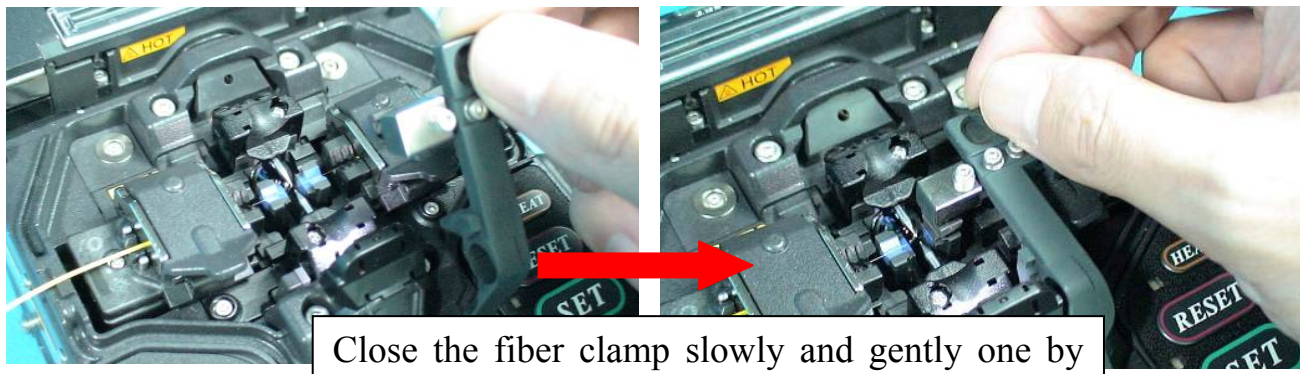

## 9. Splicing procedure

To make a good splice, the optical fiber is observed with the image processing system equipped in the FSM-60S. However, there are some cases when the image processing system cannot detect a faulty splice. Visual inspection with the monitor is often necessary for better splicing yield. Procedure below describes standard operating procedure.

- (1) Fibers loaded in the splicer move forward toward each other. The fiber forwarding motion stops at a certain position shortly after the cleaning arc is performed. Next, the cleave angle and end-face quality are checked. If the measured cleave angle is greater than its set threshold or fiber chipping is detected, the buzzer will sound and an error message warns the operator.

If no error message is displayed, the below stated end-face conditions are used for visual inspection. If observed, remove the fiber from the splicer and repeat fiber preparation. These visual defects may cause a faulty splice.

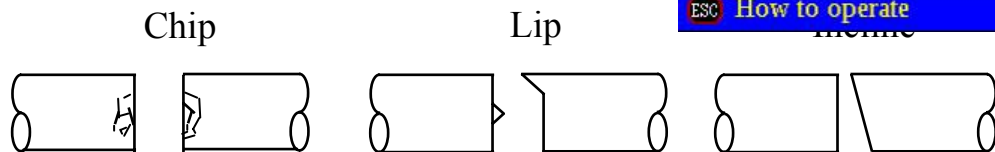
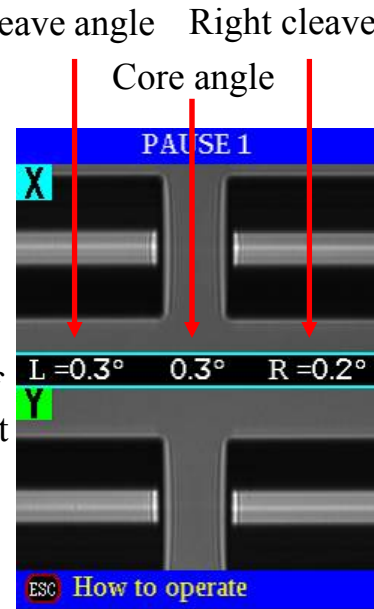

- (2) After fiber inspection, the fibers are aligned core-to-core or cladding-to-cladding. Cladding axis offset and core axis offset measurements can be displayed.



- Pause after cleave angle check and fiber alignment can be set “disabled”. See page 84 [Splice Settings] for detail.
- The cleave angle threshold can be changed. See page 84 [Splice Settings] for detail.
- The cleave angle error message can be ignored by pressing **SET** key to go on to the next step. To disable the cleave angle error. See page 84 [Splice Settings] for detail.
- Cleave angle, cladding axis offset and core axis offset during the splicing operation can be hidden. See page 84 [Splice Settings] for detail.

## Basic Operation

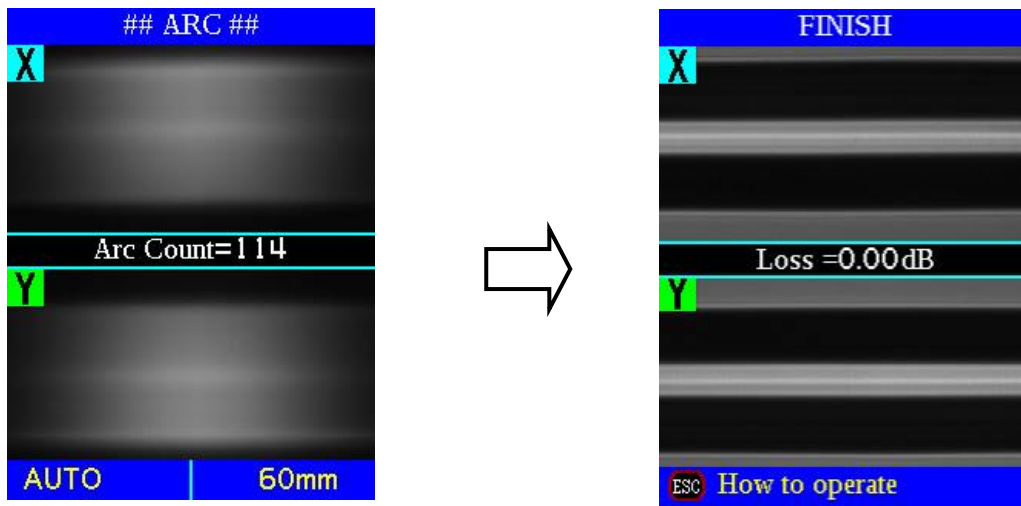

- (3) After completion of fiber alignment, arc discharge is performed to splice the fibers.
- (4) Estimated splice loss is displayed upon completion of splicing. Splice loss is affected by certain factors stated in the next page. These factors are taken into account to calculate, or estimate, splice loss. The calculation is based on certain dimensional parameters, such as MFD.
- If either the cleave angle measured or the estimated splice loss exceeds its set threshold, an error message is displayed. If the spliced fiber is detected as abnormal, such as "Fat", "Thin" or "Bubble", an error message is displayed.
- If no error message is displayed but the splice looks poor by visual inspection through the monitor, it is strongly recommended to repeat the splice from the beginning.

Splice loss may be improved in some cases by additional arc discharges. Press **ARC** key for an additional arc discharge (re-arc). Splice loss estimate and splice check are performed again.

- Splice loss may be worsened in some cases by additional arc discharges (re-arcs).  Additional arc discharge can be set to "disabled", or limited to the number of additional arcs. See [Splice Settings] page 84 for detail.

**•When splicer indicates following message, splice loss may be high.**



**“Arc discharge is not stable. Electrodes should be stabilized to reform the arc discharge.”**

**Load prepared SM fibers onto splicer in order to stabilize electrodes. After completeing it, re-splice fibers.**

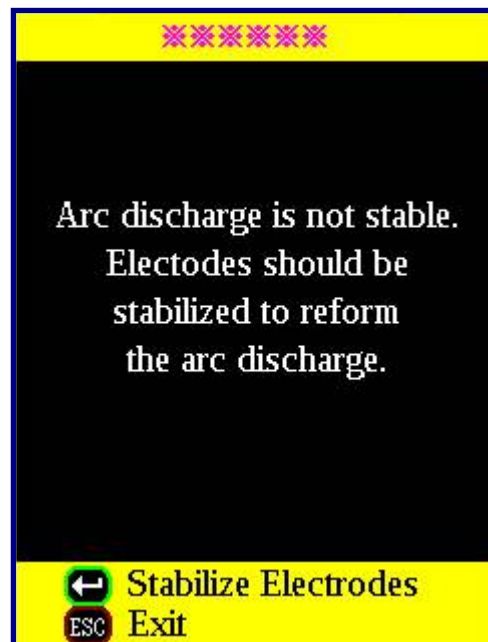



**When there is an environmental change (altitude), we recommend you to perform arc discharge proofreading.**

- Splice point sometimes looks a bit fatter than other parts. This is considered a normal splice, and does not affect splice loss.
- To change threshold for estimated splice loss or fiber angle, see [Splice Mode] page 58 for details.
- Error messages, such as "Estimated splice loss", "Splice angle", "Fat", "Thin" and "Bubble" can be ignored. This function can be set to "disabled". See [Splice Settings] page 84 for detail.

## Basic Operation

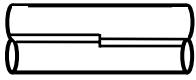
Splice loss increase: Cause and remedy

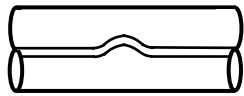
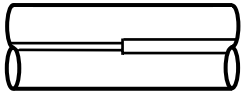
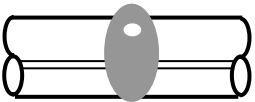
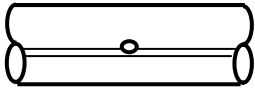
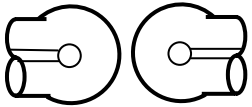
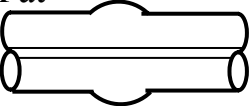
Symptom	Cause	Remedy
Core axial offset 	Dust on v-groove or fiber clamp chip	Clean v-groove and fiber clamp chip.
Core angle 	Dust on v-groove or fiber clamp chip	Clean v-groove and fiber clamp chip.
	Bad fiber end-face quality	Check if fiber cleaver is well conditioned.
Core step 	Dust on v-groove or fiber clamp chip	Clean v-groove and fiber clamp chip.
Core Curve 	Bad fiber end-face quality.	Check if fiber cleaver is well conditioned.
	Prefuse power too low or prefuse time too short.	Increase [Prefuse Power] and/or [Prefuse Time].
MFD Mismatch 	Arc power too low	Increase [Arc Power] and/or [Arc Time].
Combustion 	Bad fiber end-face quality	Check the cleaver.
	Dust still present after cleaning fiber or cleaning arc.	Clean fiber thoroughly or Increase [Cleaning Arc Time].
Bubbles 	Bad fiber end-face quality	Check if fiber cleaver is well conditioned.
	Prefuse power too low or prefuse time too short.	Increase [Prefuse Power] and/or [Prefuse Time].
Separation 	Fiber stuffing too small	Perform [Motor Calibration].
	Prefuse power too high or prefuse time too long.	Decrease [Prefuse Power] and/or [Prefuse Time].
Fat 	Fiber stuffing too much	Decrease [Overlap] and perform [Motor Calibration].

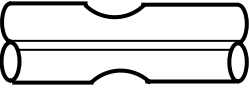
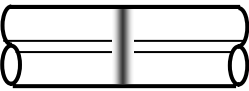

Symptom	Cause	Remedy
Thin 	Arc power not adequate	Perform [Arc Calibration].
	Some arc parameters not adequate	Adjust [Prefuse Power], [Prefuse Time] or [Overlap].
Line 	Some arc parameters not adequate	Adjust [Prefuse Power], [Prefuse Time] or [Overlap].



- A vertical line sometimes appears at the splice point when MM fibers, or dissimilar fibers (different diameters) are spliced. This does not affect splice quality, such as splice loss or tensile strength.

### Storing splicing results

Splicing results is stored in memory.



- After the 2000th result is stored, 2001st splice result is written over 1st result.

The splicing result is automatically stored in memory when **SET** key or **RESET** key is pressed upon completion of the splice at the [Finish] screen, or when the wind protector is opened upon completion of the splice at the [Finish] screen.

Once a certain comment is inputted, the same comment is inputted into subsequent splice results. To change comments, see [Splice Memory Comment].

# Basic Operation

## 10. Removing spliced fiber

- (1) Open lids of tube heater.
- (2) Open wind protector.
- (3) Hold left fiber with left hand at the edge of wind protector and open left sheath clamp or fiber holder lid.

• Keep on holding fiber until fiber is completely transferred to tube heater.

- (4) Open right sheath clamp or fiber holder lid.
- (5) Hold right fiber with right hand, and remove spliced fiber from the splicer.

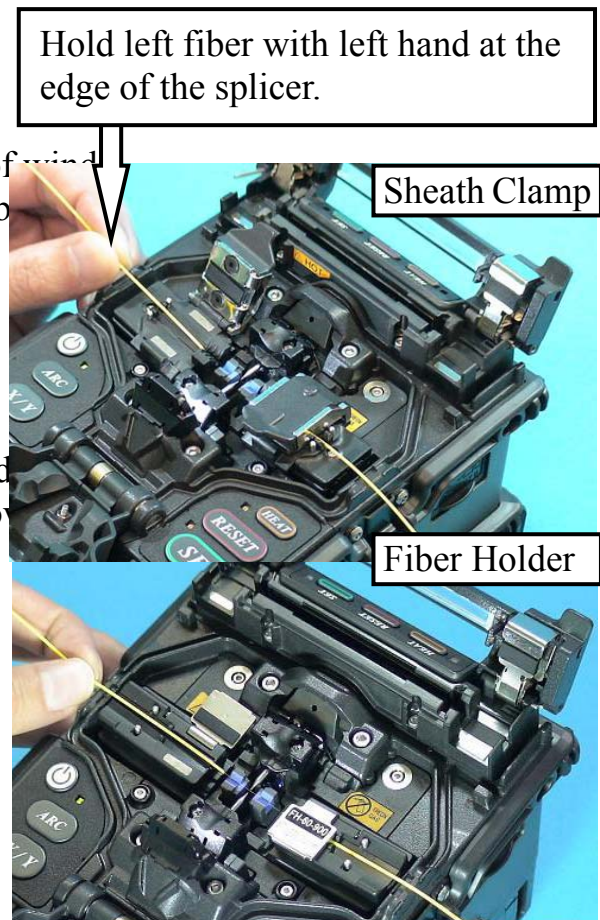

## 11. Heating protection sleeve

- (1) Transfer fiber with protection sleeve to tube heater. Protection sleeve is placed in the center of the tube heater.
- (2) Place fiber with protection sleeve in tube heater. Slide spliced fiber slowly to the right until left hand reaches the edge of the tube heater. While placing it in the tube heater, apply some tension on the fiber so the tube heater lids automatically close. . Then heating starts automatically as soon as the tube heater is closed.

• To disable the “Auto Start” function, set [Auto Start] in [Heater Menu] to turning off. See page 83 [Auto Start]. Press **HEAT** key to start tube heating when “Disable” is selected.

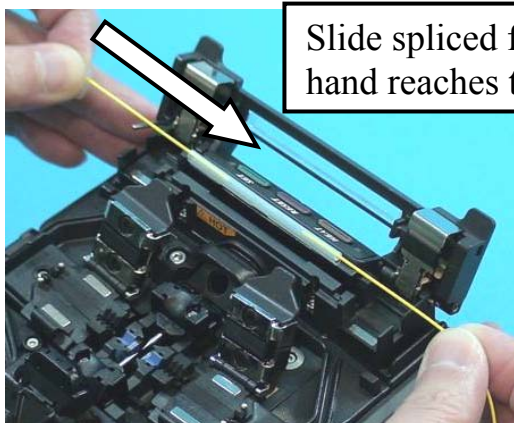

Slide spliced fiber to the right until left hand reaches the edge of tube heater.

- Make sure the splice point is located at the center of the protection sleeve.
- Make sure the strength member in the protection sleeve is placed downwards.

(3) Then HEAT LED turn on and HEAT mark displayed on the monitor.

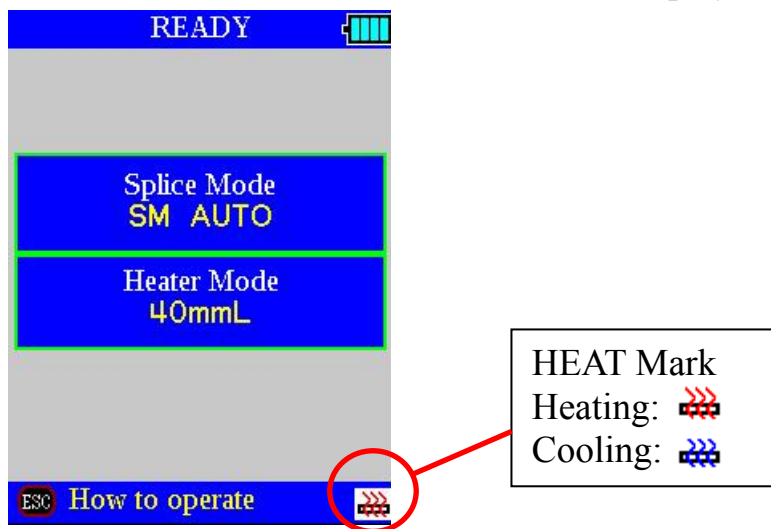

- Tube heating does not start when heater lid is opening.
- 💡 If **HEAT** key is pressed during tube heating, the HEAT LED blinks. If **HEAT** key is pressed again, the tube heating process is aborted.

The buzzer beeps and the HEAT LED (orange color) turn off when tube heating is completed.

(4) Open tube heater lids and remove protected fiber from the tube heater. Apply some tension to the fiber while removing it from the tube heater.

- 💡 • Protection sleeve may stick to bottom plate of heater. Use a cotton swab to help remove sleeve from heater.

(5) Visually inspect the finished sleeve to verify no bubbles or debris/dust is present in the sleeve.

## Basic Operation

(6) Attach the J-plate onto the splicer by installing aslant.

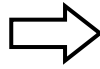

(7) Remove the protected fiber from the splicer.

- Do not touch the shrunken sleeve after removing the fiber from the tube heater. It may be hot.



(8) Place the removed fiber into the J-plate.

(9) Leave the fiber in the J-plate until the shrunken sleeve is cooled down.



## When Magnifier MGS-05 is used.

(1) Please extend both sides and insert from back.

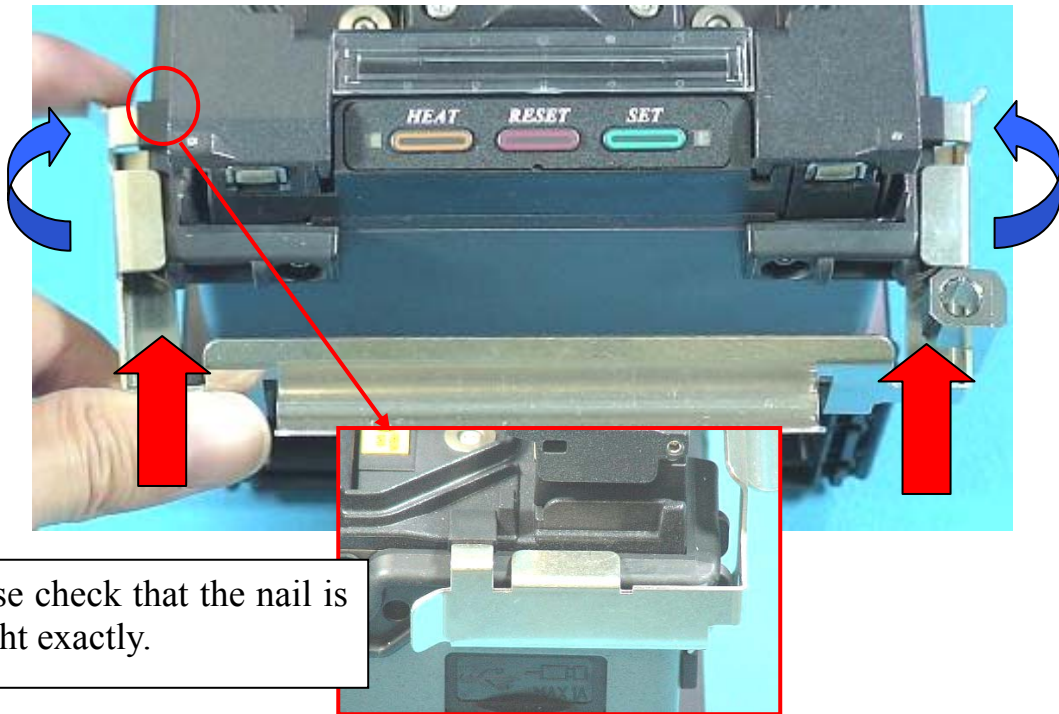

(2) A magnifying glass is fixed with an attached screw.



(3) The assembled magnifying glass is fitted over a for a shaft like the following photograph.



# Maintenance of Splicing Quality

## 1. Cleaning and Checking before Splicing

Critical cleaning points and maintenance checks are described below.

### 1-1. Cleaning V-grooves

If contaminants are present in the V-grooves, proper clamping may not occur, resulting in higher splice loss. The V-grooves should be frequently inspected and periodically cleaned during normal operation. To clean the V-grooves, do the following:

- (1) Open the wind protector.
- (2) Clean the bottom of the V-groove with an alcohol-impregnated thin cotton swab. Remove excess alcohol from the V-groove with a clean dry swab.

- Be careful to not contact the electrode tips.
- 💡 • Do not use excessive force when cleaning the V-groove. The V-groove arm may get damaged.

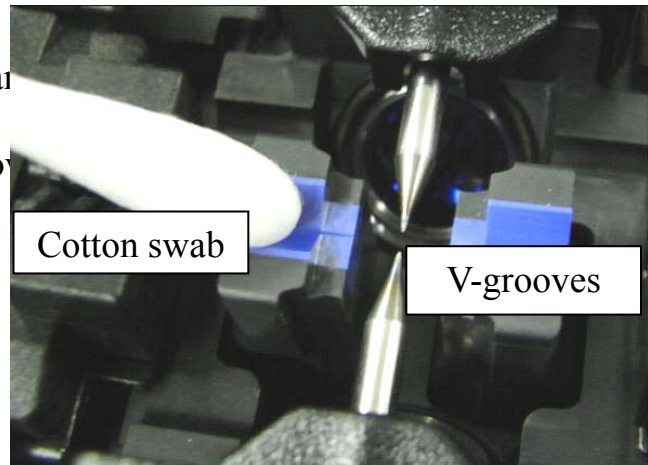

- (3) If the contaminants in the V-groove cannot be removed with an alcohol-impregnated thin cotton swab, use a cleaved fiber end-face to dislodge contaminants from the bottom of the V-groove. Repeat step (2) after this procedure.

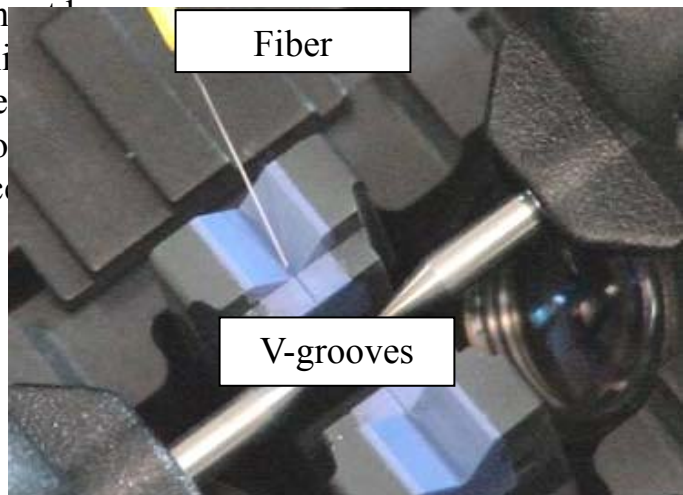

## 1-2. Cleaning Fiber Clamp Chips

If contaminants are present on the clamp chips clamping may not occur, resulting in poor quality splices. The fiber clamp chips should be frequently inspected and periodically cleaned during normal operation. To clean the clamp chips, do the following:

- (1) Open the wind protector.
- (2) Clean the surface of the chip clamp with an alcohol-impregnated thin cotton swab. Remove excess alcohol from the chip clamp with a clean dry swab.

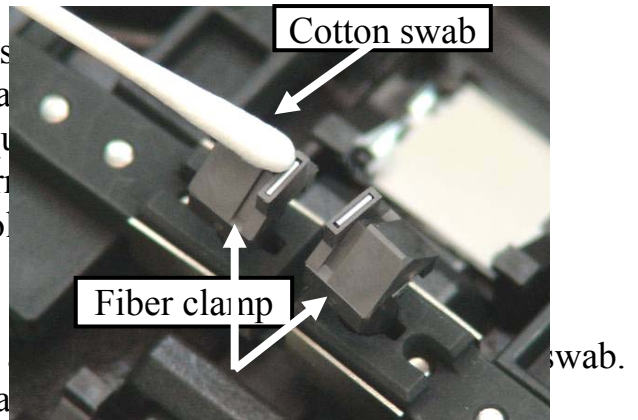

## 1-3. Cleaning Wind Protector Mirrors

If the wind protector mirrors become dirty, the core position may be incorrect due to decreased optical path clarity, resulting in higher splice loss. To clean the mirrors, do the following:

- (1) Clean the mirror surface with an alcohol-impregnated thin cotton swab. Remove excess alcohol from the mirror surface with a clean dry swab.
- (2) Mirror should look clean with no streaks or smudges.

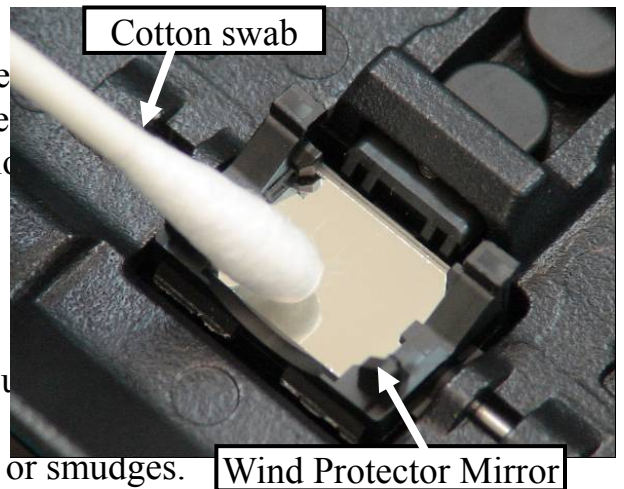

## 1-4. Cleaning Fiber Cleaver

If the circular blade or clamp pads of the fiber cleaver become contaminated, the cleaving quality could degrade. This may lead to fiber surface or end-face contamination, resulting in higher splice loss. Clean the circular blade or clamp pads with cotton swab soaked with alcohol.

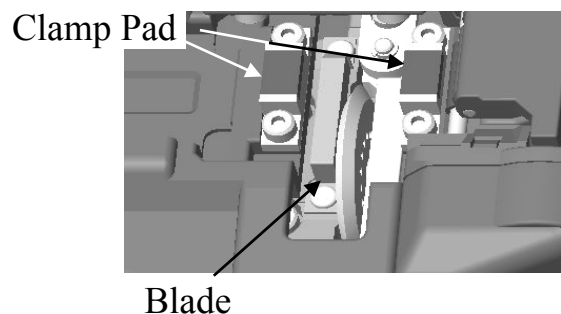
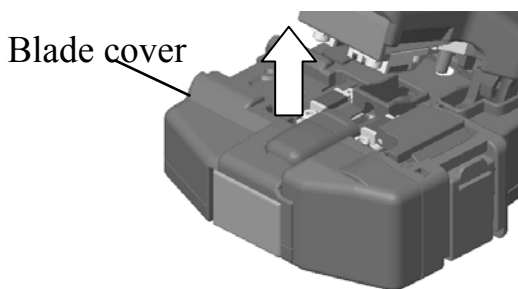

## 1-5. Arc Calibration

See Page 99 [Arc Calibration].

# Maintenance of Splicing Quality

## 2. Periodical Checking and Cleaning

In order to maintain the splicing quality of the splicer, periodical inspection and cleaning are recommended.

### 2-1. Cleaning Objective Lenses

If the objective lens's surface becomes dirty, normal observation of the core position may be incorrect, resulting in higher splice loss or poor splicer operation. Therefore, clean both of them at regular intervals. Otherwise, dirt may accumulate and become impossible to remove.

To clean the objective lenses, do the following:

- (1) Before cleaning the objective lenses, always turn off the splicer.
- (2) Gently clean the lenses' (X-axis and Y-axis) surface with an alcohol-impregnated thin cotton swab. Using the cotton swab, start at the center of the lens and move the swab in a circular motion until you spiral out to the edge of the lens surface. Remove excess alcohol from the mirror surface with a clean dry swab.

- Fujikura recommends to clean the objective lens when replace the electrode.
- Remove electrode before cleaning objective lens.
- Do not hit or touch tip of electrode when cleaning it.

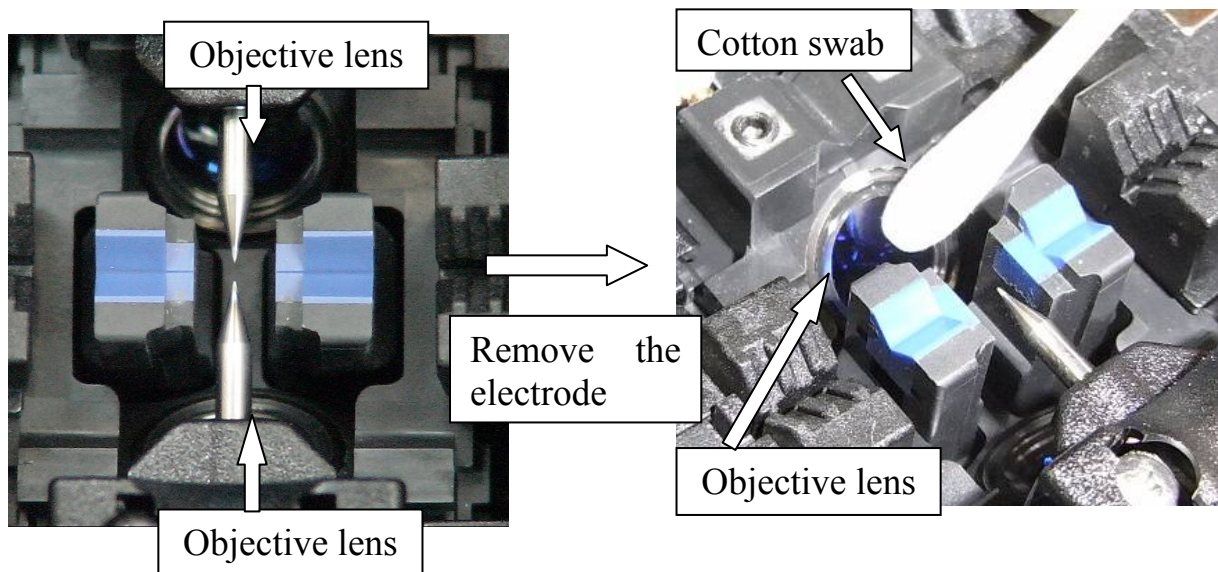

- (3) The lens surface should be clean and free of streaks or smudges.
- (4) Turn on the power and make sure no smudges or streaks are visible on the monitor screen. Press **X/Y** key to change the screen and check the state of the lens surface on both the X- and Y-screens. Perform dust check.



## 2-2. Rotating Cleaver Blade

If the cleaver does not cleave properly, rotate the blade 1/16th of a turn to replace the worn out blade position with a sharp blade position. Blade life is normally 1000 cleaves or 250 ribbon cleaves per blade position. To rotate the blade, do the following:

- (1) Remove the blade cover.
- (2) Using a 1.5mm hex wrench, remove the fiber scrap container box or the side cover.
- (3) Push the slide button until it locks.



• When rotating the blade, do not touch the cutting edge. Move the blade with a thin cotton swab, for easy and safe rotation.

- (4) Using a 1.5mm hex wrench, loosen the blade lock screw.
- (5) Rotate the circular blade 1/16th of a turn.
- (6) Tighten the blade lock screw.
- (7) Attach the blade cover.

### Blade Height Adjustment

After the circular blade has been rotated a complete revolution (16 positions), its height needs to be adjusted to compensate for the wear.

- (1) Using a 1.5mm hex wrench, remove the fiber scrap collector or the side cover.
- (2) Using a 1.5mm hex wrench, loosen the blade lock screw.
- (3) Using a 1.5mm hex wrench, loosen the adjuster lock screw.
- (4) Using a 1.5mm hex wrench, turn the adjuster clockwise so that the reference dot aligns with the next position mark. Never attempt to rotate the adjuster more than 2 position marks.
- (5) Tighten the adjuster lock screw.
- (6) Tighten the blade lock screw.



• After blade height adjustment, the 16 blade positions can be used again. If the cleaver does not cleave properly, rotate the blade.

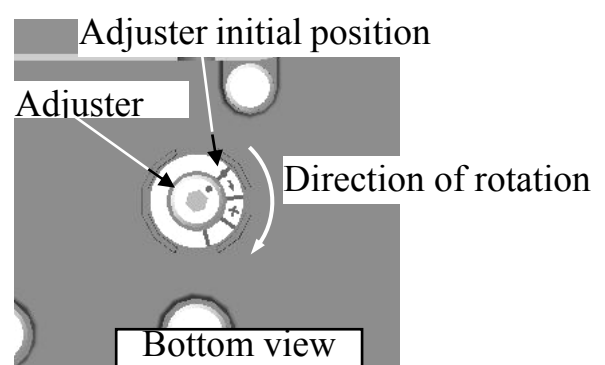
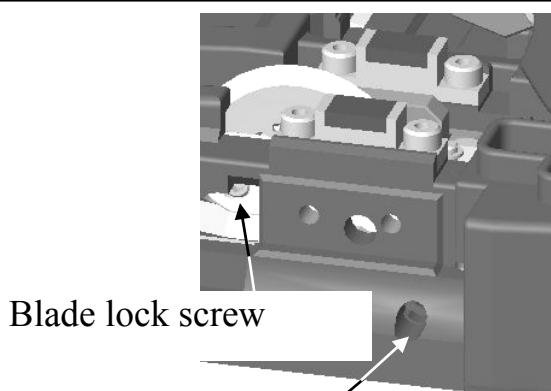

### Blade Replacement

After the circular blade has been raised 3 times and rotated through all positions (a total of approximately 48,000 fiber splices), it needs to be replaced. Contact your Fujikura splicer distributor.

# Maintenance of Splicing Quality

## 2-3. Replace Wind Protector Mirrors

Replace the wind protector mirror if it cannot be cleaned or if it remains clouded. To replace, do the following:

- (1) Turn the splicer power off.
- (2) Open the wind protector. Pull and unlock wind protector mirror latch with fingers. While still pulling on mirror latch, use other hand's fingers to pull on wind protector mirror frame. The frame should raise and rotate back. Pull out the mirror from its frame.

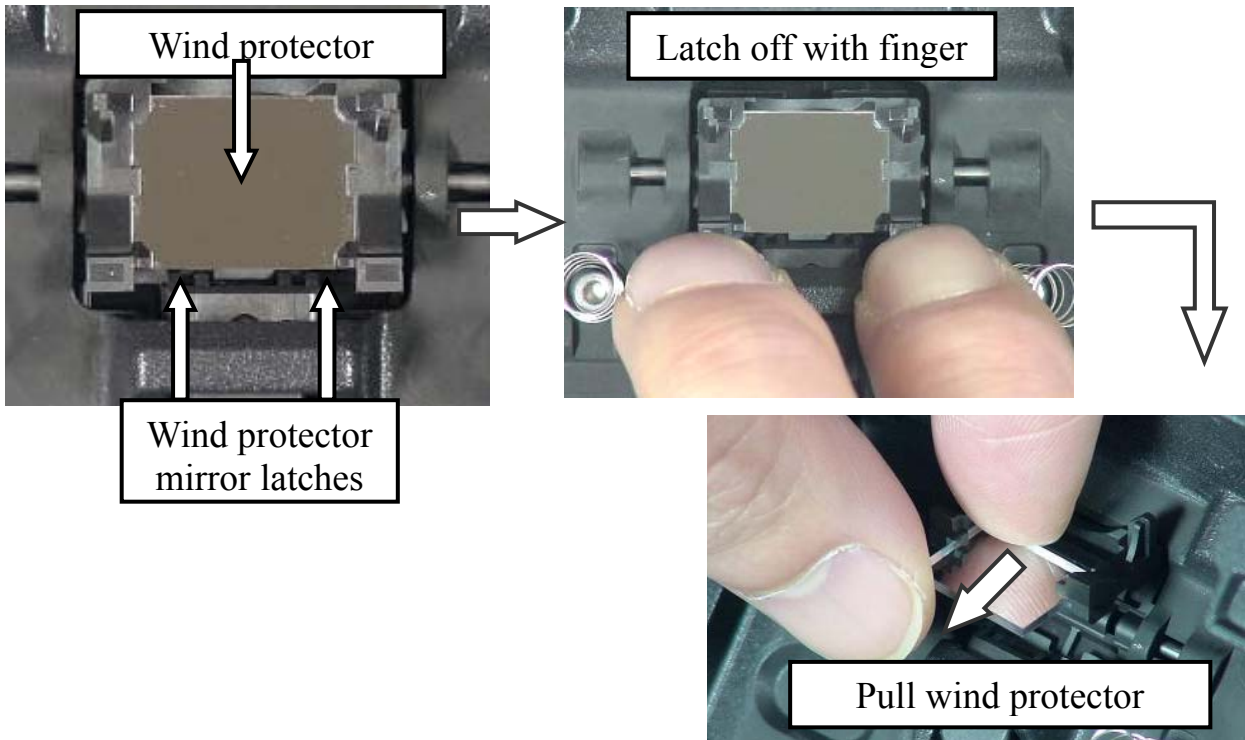

- (3) Insert the new mirror into the frame. The clear glass side should face upward while inserting mirror into the frame. Look into the mirror obliquely to identify. If it is the clear side, black line can be seen.

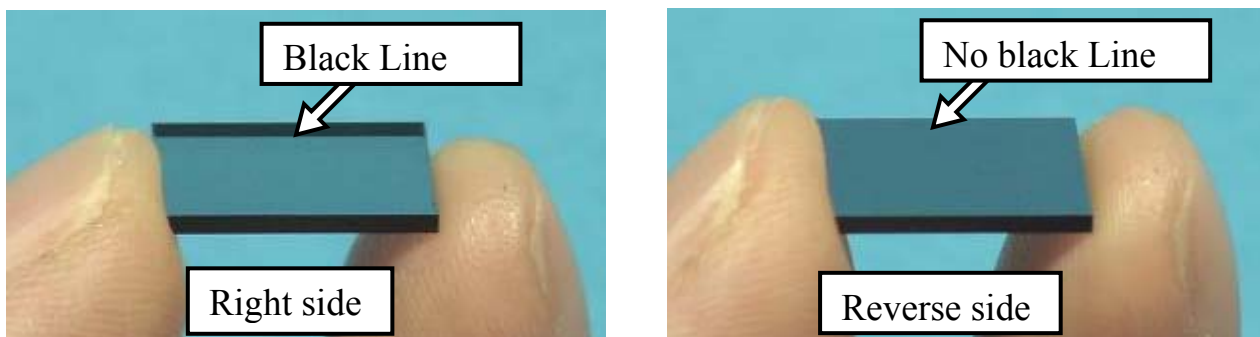

- Make sure the wind protector mirror is inserted the correct way. If not, the fiber cannot be observed correctly.
- Wind Protector Mirror is **WPM-08**.

(4) Clean Wind Protector Mirrors.

(5) Turn on the power and make sure no smudges or streaks are visible on the monitor screen. Press **X/Y** key to change the screen and check the state of the lens surface on both the X- and Y-screens. Perform dust check.

### ***2-4. Electrode Replacement***

See page 93 [Replace Electrodes].

### ***2-5. Diagnostic Test***

See page 97 [Diagnostic Test Function].

## 1. Splice Mode

The optimum splice setting for a specific fiber combination consists of the below listed splicing parameters. In other words, the optimum splicing parameters depend on the fiber combinations, and are different from fiber to fiber.

- Parameters for controlling arc discharge / heating.
- Parameters for calculating estimated splice loss.
- Parameters for controlling fiber alignment and splicing procedures.
- Threshold for error messages.

A series of optimum splice parameters for major fiber combinations are already stored in the splicer. These parameters are stored in the database area and can be copied to the user-programmable area. These splice parameters can be edited for a specific fiber combination.

### How to select the “Splice Mode”

- For those who prefer stable splice loss (rather to quick splicing with high yield). Use the “AUTO” mode.
- For those who are not sure of the optical fiber type to be spliced. Use the “AUTO” mode.
- For those who would like to shorten splicing time with AUTO modes. If the type of optical fiber has already been identified, use “SM AUTO”, “MM AUTO” or “NZ AUTO” depending on the fiber type. These exclusive AUTO modes skip a process for fiber type identification, so the total splicing processes take less time.
- For those who prefer quick splice of SMF with high yield to consistent splice loss. Use “SM FAST” Mode
- For those who splice non-conventional fibers, select the best suit splicing mode in “Other Mode”. “AUTO” splice modes do not cover non-conventional fiber splicing.
- For those who prefer the lowest possible splice loss to any other considerations. Use “Other Mode” and optimize splicing condition for your specific fiber combination.



## Database

Splice Mode	Description
<p style="text-align: center;">AUTO</p>	<p>This splice mode observes the core profile of the optical fiber, and automatically identifies the fiber type being SM, MM or NZDS. A set of splicing parameters is selected for the identified fiber type and the fibers are automatically spliced. This is beneficial if the fiber type is uncertain. The identified fiber type is displayed in the lower left hand corner of the monitor.</p> <p>The heat amount applied to the fiber is calibrated in real time by analyzing the cladding illumination during arc discharge then adjusting the arc current accordingly. This splice mode does not require operator to perform an arc calibration.</p> <div style="border: 1px solid black; border-radius: 15px; padding: 10px; margin-top: 10px;"> <p style="text-align: center;"> Points to note of AUTO mode</p> <ol style="list-style-type: none"> <li>(1) Fiber types that can be identified are standard SM, MM and NZDS. However, some fibers with unique core profile may not be correctly identified. If this is the case, the recommendation is to use the other splice modes.</li> <li>(2) NZDS fiber is spliced using the splicing mode for standard NZDS. However, for best results, it is recommended that the optimum splice mode be selected for a specific type of NZDS fiber. This is due to the variation in the NZDS fiber properties and optimum splicing parameters are different from one type of NZDS fiber to the next.</li> <li>(3) DS fiber is identified as NZDS when using AUTO mode.</li> </ol> </div>

## Splice Menu

Splice Mode	Description
SM	For splicing standard Single-mode fiber (ITU-T G652). The MFD is 9 to 10 $\mu\text{m}$ at wavelength of 1310 nm. Automatic arc calibration doesn't work in this splice mode.
NZ	For splicing Non-zero dispersion-shifted fiber (ITU-T G655). The MFD is 9 to 10 $\mu\text{m}$ at wavelength of 1550 nm. Automatic arc calibration doesn't work in this splice mode.
DS	For splicing Dispersion-shifted fiber (ITU-T G653). The MFD is 7 to 9 $\mu\text{m}$ at wavelength near 1550 nm. Automatic arc calibration doesn't work in this splice mode.
MM FAST	For splicing Multi-mode fiber (ITU-T G651). Core diameter : 50.0 to 62.5 $\mu\text{m}$ Automatic arc calibration does not work in this mode. AUTO mode uses this splice condition with the automatic calibration when splicing MM fibers. By using this mode, occurrence of bubbles is low even if the cleaver or electrode condition is not good, but the appearance of splice point may appear slightly fat. If a bubble still occurs, use the MM-MM mode, and increase [Prefuse Time] and [Prefuse Power].
SM AUTO	For splicing standard Single-mode fiber (ITU-T G652). The MFD is 9 to 10 $\mu\text{m}$ at wavelength of 1310 nm. Automatic arc calibration works in this splice mode.
NZ AUTO	For splicing Non-zero dispersion-shifted fiber (ITU-T G655). The MFD is 9 to 10 $\mu\text{m}$ at wavelength of 1550 nm. Automatic arc calibration works in this splice mode.
MM AUTO	For splicing Multi-mode fiber (ITU-T G651). Core diameter : 50.0 to 62.5 $\mu\text{m}$ Automatic arc calibration works in this splice mode.
DS AUTO	For splicing Dispersion-shifted fiber (ITU-T G653). The MFD is 7 to 9 $\mu\text{m}$ at wavelength of 1550 nm. Automatic arc calibration works in this splice mode.
Other splice modes	There are many types of splice modes in this splicer, other than the ones stated above, stored in the splicer database. Select a "BLANK" splice mode, and press <b>Menu</b> key. Then press <b>Enter</b> key. Nearly 60 splice modes stored in the database are displayed. Select one splice mode to be used.

## 1-1. Splice mode selection

Select an appropriate splice mode for type of fiber to be spliced.

- (1) Press **Menu** key at [READY], [PAUSE1], [PAUSE2] or [FINISH] state to open [Splice Menu]. Select [Select Splice Mode] and the [Select Splice Mode] menu is displayed.
- (2) Move cursor by pressing **Up/Down** Arrow key and press **Enter** key to select [Splice mode].

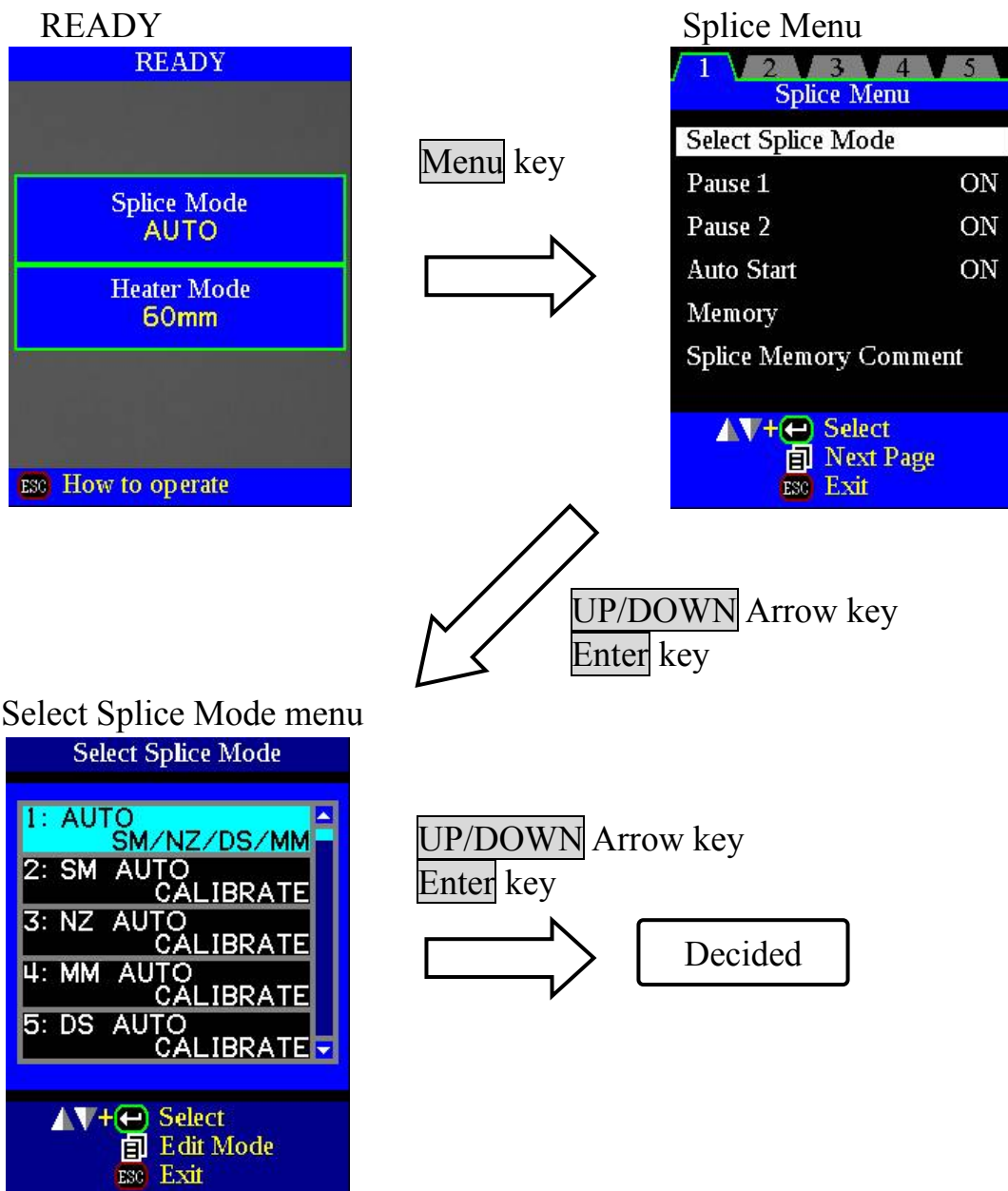

# Splice Menu

## 1-2. Creating or erasing splice mode

### How to create splice mode

There are 8 splice modes stored when the splicer is first delivered, and all the other modes are displayed [BLANK]. Follow the below steps to add splice mode.

Select a “BLANK” splice mode and press **Menu** key. Nearly 60 splice modes stored in the splicer database are displayed. Select one splice mode to be copied. Press **Enter** key to execute. Press **Escape** key to verify the fiber type is named in the specific splice mode.

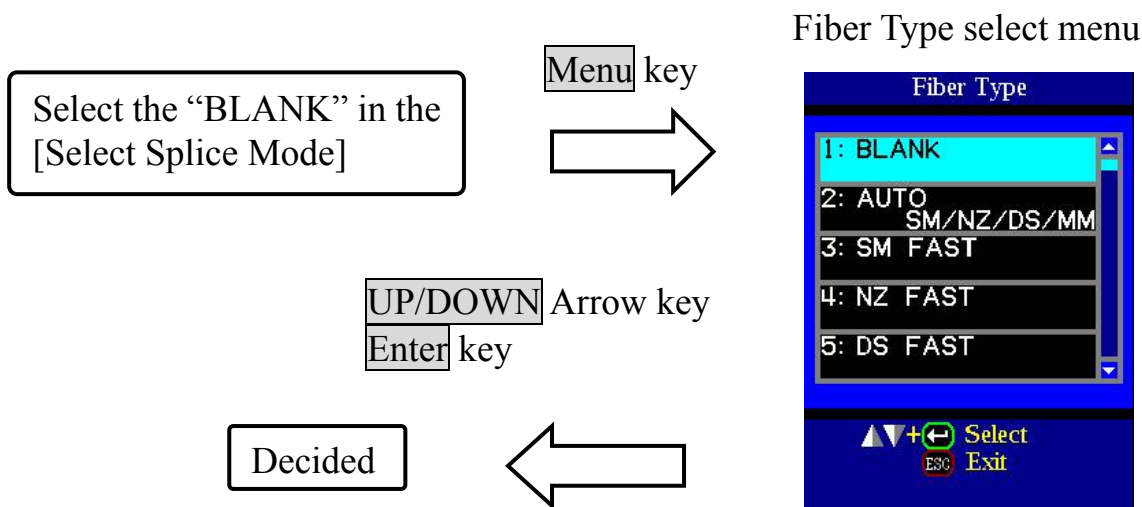

### How to erase splice mode

Splice mode can be erased. Follow the below steps to erase splice mode.

- (1) Select the specific splice mode and press **Menu** key to go to [Edit Splice Mode] menu. Select [Fiber Type] by pressing **Enter** key.
- (2) Select the “0: BLANK” and press **Enter** key to execute.

 • Mode No.1 cannot be erased.  
• Mode No.1 is automatically selected after erasing a splice mode.

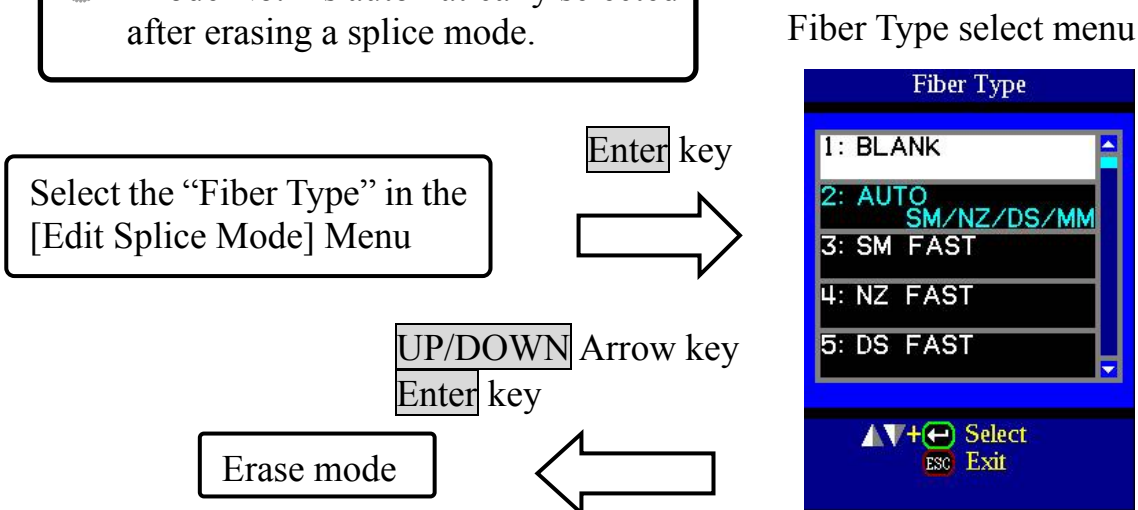



## 1-3. Referring or editing splice mode

Splicing parameters in each splice mode can be modified. Arc power and Arc time are considered the two most vital parameters. To edit parameters follow below steps:

- (1) In [Select Splice Mode] menu, move cursor to a splice mode to be modified. Press **Menu** key to display [Edit Splice Mode] menu.
- (2) Move cursor by pressing **Up/Down** Arrow key to a parameter to be changed.
- (3) Press **Enter** key to select parameter. Press **Up/Down** Arrow key to change its value. Press **Enter** key to accept changed values.

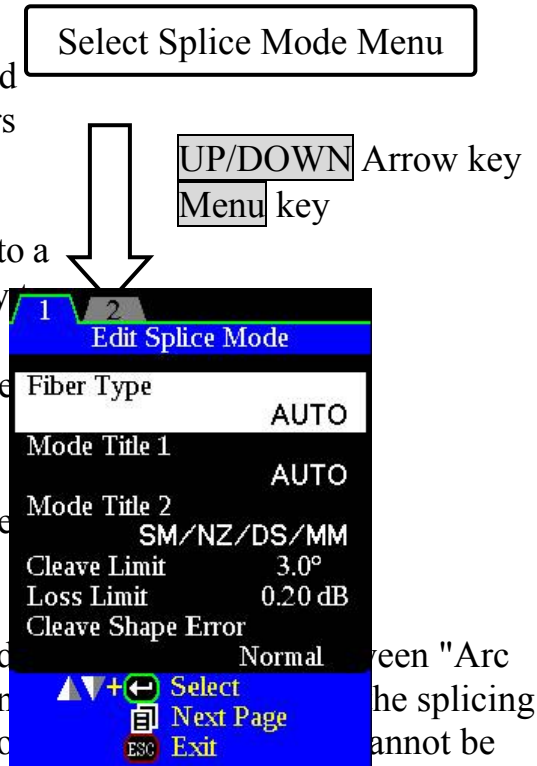

Below is a figure showing the Arc discharge condition (Arc power" and "Motor motion"). The conditions can be changed. Depending on splice mode, some parameters listed below. Depending on splice mode, some parameters cannot be changed.

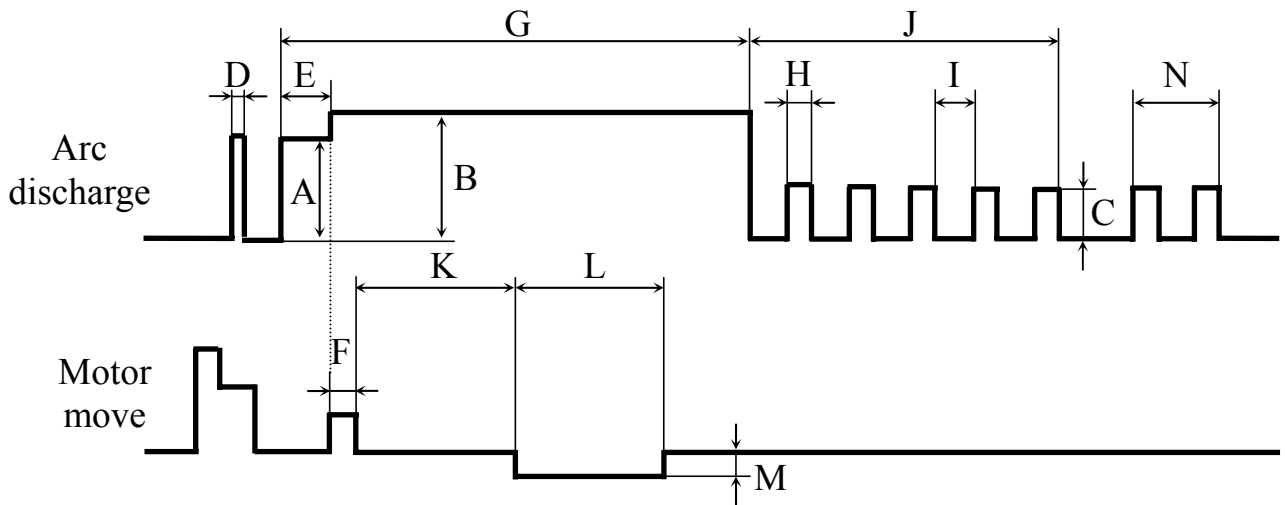

- |                                     |  |                |
|-------------------------------------|--|----------------|
| A: Prefuse Power,                   | B: Arc1 Power,                         | C: Arc2 Power, |
| D: Cleaning Arc,                    | E: Prefuse Time,                       |                |
| F: Forward Time related to Overlap, | G: Arc1 Time,                          |                |
| H: Arc2 ON Time,                    | I: Arc2 OFF Time,                      | J: Arc2 Time,  |
| K: Taper Wait Time,                 | L: Taper Time related to Taper Length, |                |
| M: Taper Speed,                     | N: Rearc Time                          |                |

## Splice Menu

Below is a list of Splicing parameters for AUTO modes

AUTO mode : [AUTO], [SM AUTO] , [MM AUTO] , [NZ AUTO] , [DS AUTO]

Only a limited number of parameters listed below are displayed for AUTO, SM, DS, MM and NZ modes to simplify the operation. Additional hidden parameters are all fixed values set at the factory.

Parameter	Description
Fiber Type	List of splice modes stored in database is displayed. A selected splice mode stored in the database area is copied to a selected splice mode in the user-programmable area.
Mode Title1	Title for a splice mode expressed in up to nine characters.
Mode Title2	Detail explanation for a splice mode expressed in up to 15 characters. Title2 is displayed at the [Splice Mode Select] menu.
Cleave Limit	An error message is displayed if the cleave angle of either the left or right fiber ends exceeds the selected threshold (cleave limit).
Loss Limit	An error message is displayed if the estimated splice loss exceeds selected threshold (loss limit).
Cleave Shape Error	Error message is displayed if the cleaved end face of either left or right fiber exceeds the selected threshold (cleave shape).
Arc Power	The Arc Power is fixed at STANDARD. The Arc Power is changed automatically.
Arc Time	Arc Time is fixed at 1500 ms for SM and DS modes, 2000ms for NZ mode, and 3000 ms for MM mode. This is automatically set depending on the fiber type when AUTO mode is selected.
Cleaning Arc	A cleaning arc burns out micro dust on the surface of the fiber with an arc discharge for a short period of time. The duration of the cleaning arc can be changed by this parameter.
Rearc Time	Splice loss may be improved by an additional “rearc” discharge in some cases. The duration of this additional arc can be changed by this parameter.



- Menus change when [Fiber Type] is set other splice modes, e.g. SM-SM mode.

## Splicing parameters: standard modes

Standard mode : [SM], [MM], [NZ], [DS]

In other splice modes in the user-selectable database, the user can select one from a series of factory-set splicing modes for various splicing combinations. Below are the descriptions of the various parameters used in these modes.

Parameter	Description
Fiber Type	A list of splice modes stored in the splicer database is displayed. Upon inputting the appropriate mode, the selected splice mode stored in database area is copied to a selected splice mode in user-programmable area.
Mode Title1	Title for a splice mode expressed in up to seven characters.
Mode Title2	Detail explanation for a splice mode expressed in up to 15 characters. Title2 is displayed at the [Splice Mode Select] menu.
Align	Sets the aligning method for the fibers. “Core” : Aligns fibers by core position. “Clad” : Aligns fibers by center position of the cladding of the fiber. “Manual” : Aligns fibers manually.
Focus-L Focus-R	Sets the focal point for fiber observation. The focal point moves closer to the core when [Focus] value is increased. "Auto" focus is strongly recommended, as [Focus] optimization is very difficult. Left and right fibers are focused independently even if they are a different fiber type (dissimilar fiber splicing). If the fiber core cannot be observed (e.g. MM fiber), use the “Edge” parameter. [Align] and [Est. Mode] are automatically fixed to the “Clad” setting. [ECF] and [Auto Power] are automatically fixed to the "OFF" setting.
ECF	Sets the axial offset ratio for ECF. See page 70 [ECF Splice] for detail. For a splice mode in which arc time is 5 sec. or longer, setting [ECF] "OFF" is recommended. If [Align] is set to "Edge", “Clad” or "Manual", [ECF] is automatically fixed to "OFF". If [ECF] is set "OFF", [Auto Power] is automatically fixed to "OFF".
Auto Power	Optimizes Arc power according to core concentricity-error. This function is used in combination with ECF. If [ECF] is set to "OFF", [Auto Power] is automatically fixed to "OFF"
Proof Test	If [Proof Test] is set to "ON", a proof-test is performed upon opening the wind protector after splicing or by pressing the <b>SET</b> key.

## Splice Menu

Parameter	Description
Cleave Limit	An error message is displayed if the cleave angle of either the left or right fiber ends exceed the selected threshold (cleave limit).
Loss Limit	An error message is displayed if the estimated splice loss exceeds the selected threshold (loss limit).
Fiber Angle Limit	An error message is displayed if the bend angle of the two fibers spliced exceeds the selected threshold (Fiber Angle Limit).
Cleave Shape Error	Error message is displayed if the cleaved end face of either left or right fiber exceeds the selected threshold (cleave shape).
Cleaning Arc	A cleaning arc burns out micro dust on the surface of the fiber with an arc discharge for a short period of time. The duration of the cleaning arc can be changed by this parameter.
Gap	Sets the end-face gap between the left and right fibers at the time of aligning and pre-fusion discharge.
Gapset Position	Sets the relative position of the splicing location to the center of electrodes. Splice loss may be improved in the case of dissimilar fiber splicing by shifting [Gapset Pos] towards a fiber whose MFD is bigger than the other fiber MFD.
Prefuse Power	Sets the power of the prefuse arc, which is an arc discharge occurring from the beginning until the fibers begin stuffing. If [Prefuse Power] is set too low, axial offset may occur if cleaved angles are relatively poor. If [Prefuse Power] is set too high, fiber end faces are fused excessively and splice loss gets worse.
Prefuse Time	Sets the duration of the prefuse arc, which is arc discharge occurring from the beginning until the fibers begin stuffing. Longer [Prefuse Time] is synonymous with higher [Prefuse Power].
Overlap	Sets the overlap amount of fibers at the fiber stuffing stage. Relatively small [Overlap] is recommended if the [Prefuse Power] is low, while relatively large [Overlap] is recommended if the [Prefuse Power] is high.
Arc1 Power	Arc discharge can be separated into two stages. Arc1 Power is the first stage. This sets Arc1 Power.
Arc1 Time	Sets Arc1 time. <b>Caution</b> If Arc1Time is set 1 sec. or less and Arc2 Power is set to "OFF", the splice may break during proof-test stage.

Parameter	Description
Arc2 Power	Arc2 is the second arc discharge stage. This sets Arc2 Power.
Arc2 Time	Sets the total Arc2 time. Usually set this value to "OFF". It is possible to set a very long arc time. However, when the total of the Arc 1 time and Arc2 time exceeds 30 seconds, always adjust the function [Arc2 ON Time] and [Arc2 OFF Time] to weaken the arc power. A continuous arc over 30 seconds, without weakening the arc power, may damage the arc discharge unit.
Arc2 On-Time	During Arc2 discharge, arc power can be pulsed by turning the arc on and off. This sets the amount of time that Arc2 is ON.
Arc2 Off-Time	Sets Arc2 OFF Time during Arc2. When the Arc2 discharge is intermittent, re-arc discharge is also intermittent. When continuous re-arc discharge is necessary, set this parameter to "OFF".
Rearc Time	Sets Rearc Time. In other splice modes, the Re-arc power is automatically fixed to the same arc power of [Arc2 Power]. If Arc2 is set ON and OFF, Re-arc is automatically set ON and OFF.
Taper Splice	Splice loss is sometimes improved when the fiber is tapered (pulled) during arc discharge to make the splice thinner. This sets taper function "ON". The following three parameters determine the taper shape.
Taper Wait	Sets the taper wait time from the end of fiber stuffing until the start of pulling fiber.
Taper Speed	Sets the fiber pulling speed.
Taper Length	Sets the fiber pulling length.
Estimating Mode	Selects splice loss estimation mode to "OFF", "Clad", "Core" or "Core-Fine". When MM fibers are spliced, select "Clad".
MFD-Left	Sets MFD of the left and right fibers. Both MFD-L & R are taken into account for estimating splice loss.
MFD-Right	
Minimum Loss	This amount is added to the estimated splice loss originally calculated. When splicing specialty or dissimilar fibers, a high actual splice loss may occur even with optimized arc conditions. To make the actual splice loss concur with the estimated splice loss, set the minimum value of estimate to the minimum optimized actual splice loss.
Core Step	Determines how Core step, Core curve and MFD mismatch influences splice loss estimate. If Est. Mode is set "OFF" or "CLAD", these Core step, Core curve and MFD mismatch are automatically set "OFF". If the estimated splice on certain fiber combinations needs adjustment, Core step, Core curve and MFD mismatch are used. These are advanced splicer functions and should be discussed with your Fujikura representative before changing.
Core Curve	
MFD Mismatch	

# Splice Menu

## 1-4. How to input Mode Title / Comment / Password

Character list below is displayed by selecting Mode Title / Comments / Password.

(1) Move the cursor by pressing **Up/Down** Arrow key, **Menu** key, and press **Enter** key to input the selected character. If an incorrect character is inputted, move the cursor to **[BS]** and press **Enter** key to highlight the character, and then input the proper character over it.

(2) Move cursor to **[ENTER]** on left side and press **Enter** key on completion of inputting characters. In the case of Password input, the next screen image is displayed if the correct password is inputted. If the input password is incorrect, the previous screen image is displayed.



	Description
[ENTER]	Input the Password
[BS]	Back Space
[DEL]	Delete the character
[INS]	Insert the Space
[Left] and [Right] arrow	Move the cursor on inputted character
[SMALL] or [CAPS]	Change the character type

## 1-5. Manual Splice Mode

This mode is to manually align and splice fibers. The following procedure is required, and is different from standard automatic splicing.

- (1) Press **SET** key to drive the fibers forward. The fibers stop moving forward at the Gapset position.
- (2) Select a motor to be manually moved by pressing **Up/Down** Arrow key. The name of the motor to be moved is displayed in the monitor. Motor speed can be selected "fast" or "slow" by pressing **Enter** key.
- (3) Press **Up/Down** Arrow key to move the selected motor and drive the fibers forward or backward.
- (4) After manual alignment is completed, press **ARC** key to arc and splice the fibers.

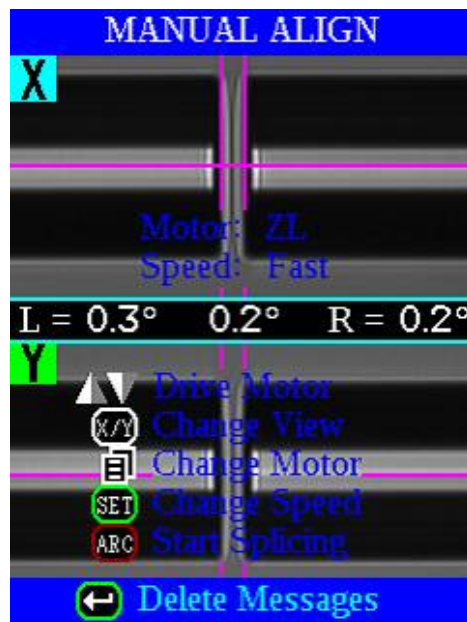

- The splicer beeps if motor stroke comes to its limit and the motor stops. Press the opposite arrow key to move the motor again.
- 💡 • Display messages can be erased by pressing **Menu** key. The message can be displayed by pressing **Menu** key again.

Motor	<b>Up</b> Arrow key	<b>Down</b> Arrow key
ZL/ZR	Forward	Backward
X/Y	Upward	Downward
Focus X Focus Y	Lens moves nearer fiber.	Lens moves away from fiber.

# Splice Menu

## 1-6. ECF Splice

When fibers having some core concentricity-error are aligned using the core-to-core method, their outer claddings are not aligned in line with each other as shown below. However, surface tension created during arc discharge aligns the fibers cladding-to-cladding due to the viscous self-centering effect. This results in a high splice loss due to the fact that the cores of the fibers are offset during the process.

The ECF (Eccentricity Correct Function) function in the splicer prevents this from happening. The amount of offset expected due to this surface tension phenomenon is calculated in advance, and this is taken into account to determine an intentional core axis offset amount that is added after the fiber cores are aligned. With this function, the fibers are core-to-core spliced even with the effect mentioned above. Some "Core step" may remain at splice point but this gives much lower splice loss than core axial offset. A long arc discharge counteracts ECF, because surface tension eventually aligns and splices fibers cladding-to-cladding. Canceling [ECF] by setting this "OFF" reduces core step amount and increases core axial offset.

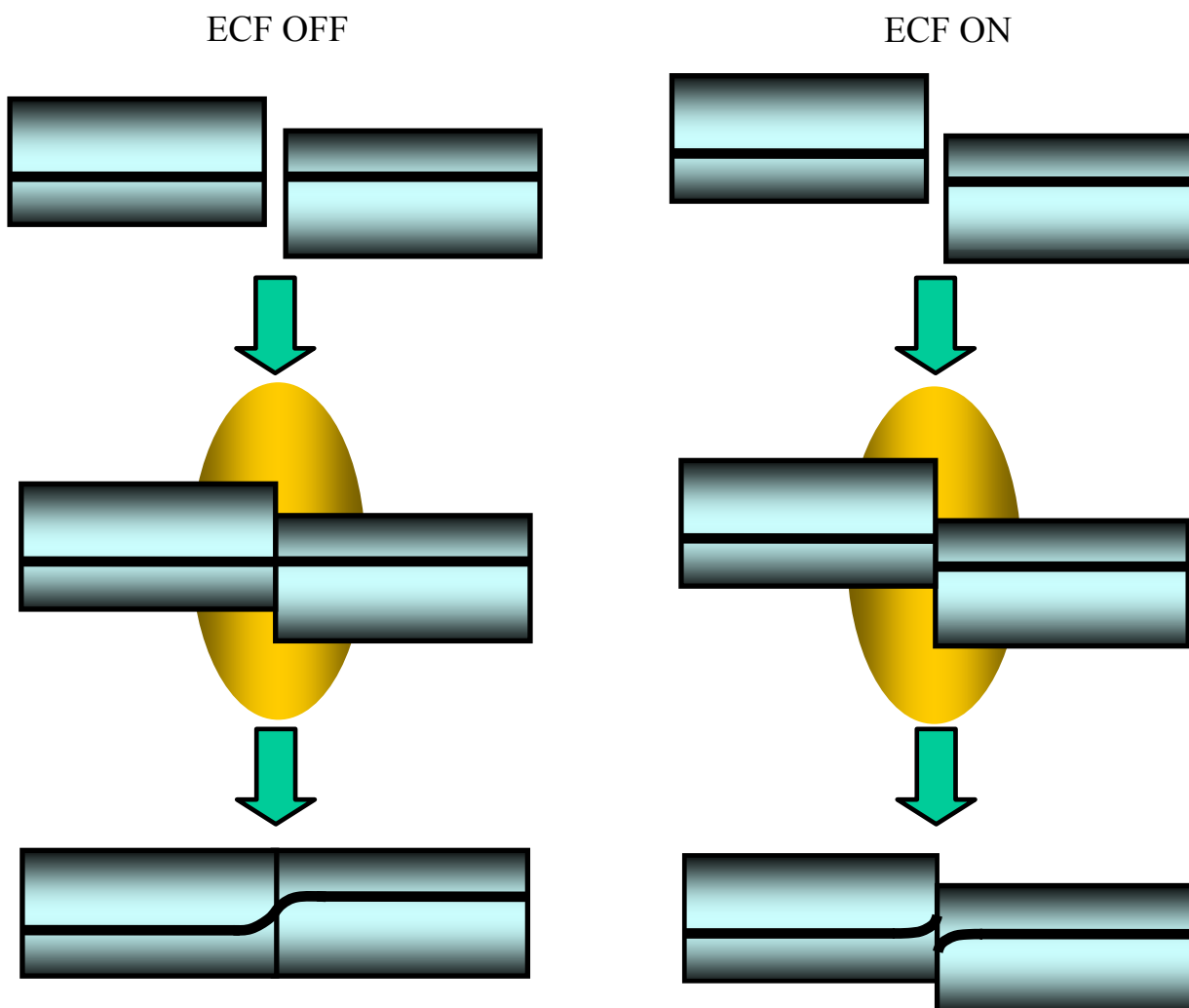



## 1-7. Attenuation splice mode

Attenuation splice mode makes an intentional core axial offset to create attenuation at the splice point. Two types of attenuation splice modes are included in the splicer as stated below.

Select either "AT1(SM)", "AT1(DS)", "AT2(SM)", "AT2(DS) or AT2(MM) in data base area at [Fiber Type].

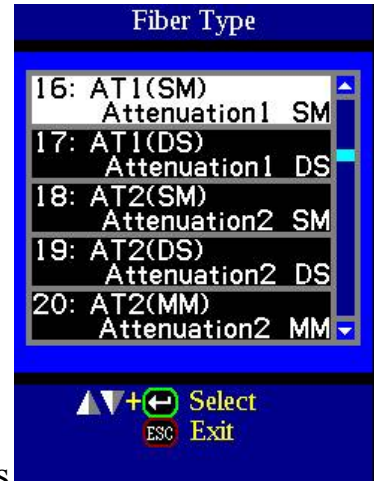

### [AT1] mode

[AT1] creates an intentional core axial offset and splices fibers. It provides an estimated splice loss, but this should be regarded as a reference as the estimated splice loss may not be correct in some cases, depending on fiber properties. A power meter is recommended for correct splice loss measurements.

#### Splicing parameters

Parameter	Description
Target Loss	Sets target splice loss.
MFD	Sets MFD of fibers to be spliced.
Coefficient	If actual splice loss measured does not match [Target Loss], the "coefficient" can be used to adjust this. This is often more practical than "Target loss" or "MFD" in terms of accuracy.
Other Parameters	Refer to other splice modes for complete description.

### [AT2] mode

This mode allows the users to set a starting core offset value and a finishing core offset value. Set [Start Offset] manually and then splicing starts. Re-arc is performed continuously / automatically until the axial offset reaches [Stop Offset] value. A splice loss estimate is not performed.

#### Splicing parameters

Parameter	Description
Start Offset	Sets axial offset amount before splicing.
Stop Offset	Re-arc is continuously performed until axial offset reaches specific offset amount [Stop Offset]. Axial offset amount decreases as splicing occurs, so [Stop Offset] must always be smaller than [Start Offset]. The maximum amount of [Stop Offset] is 80% of [Start Offset].
Other Parameters	Refer to other splice modes for complete description.

## *Splice Menu*

---

- [AT2] mode provides more stable performance than [AT1] mode, but some variation may inevitably occur. To decrease variation, set the [Cleave Limit] as low as possible.



- Attenuation splices made with [AT1] / [AT2] modes are not as accurate as power meter attenuation feedback splicing.
- [AT2 (MM)] mode is for attenuation splicing with MM fiber. Cladding alignment is performed with [AT2 (MM)] mode.

## 2. Splice Option

Common parameters for all the modes for splicing and tube heating can be set.

- (1) Press **Menu** key at [READY], [PAUSE1], [PAUSE2] or [FINISH] state to open [Splice Menu].
- (2) Select a parameter to be changed.
- (3) Press **Enter** key to change values.

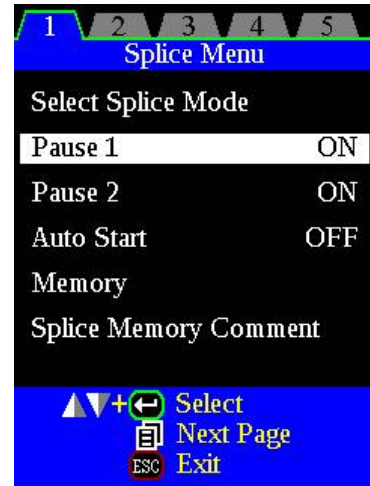

### Setting parameters

Parameter	Description
Pause1	If "Pause1" is set to "ON", splicing operation pauses when fibers are forwarded to gap-set position. Cleave angles are displayed during the pause.
Pause2	If "Pause 2" is set to "ON", splicing operation pauses after fiber alignment is completed. With ECF "ON", core-to-core alignment is made after this pause.
Auto Start	If "Auto Start" is set to "ON", splicing starts automatically as soon as the wind protector is closed. Fibers should be prepared and placed into the splicer in advance.

# Splice Menu

## 3. Splice Memory

This splicer stores up to 2,000 splicing results. Contents of data stored are different depending on splicing mode. No results are stored for "attenuation splicing".

SM / NZ / DS / MM / AUTO

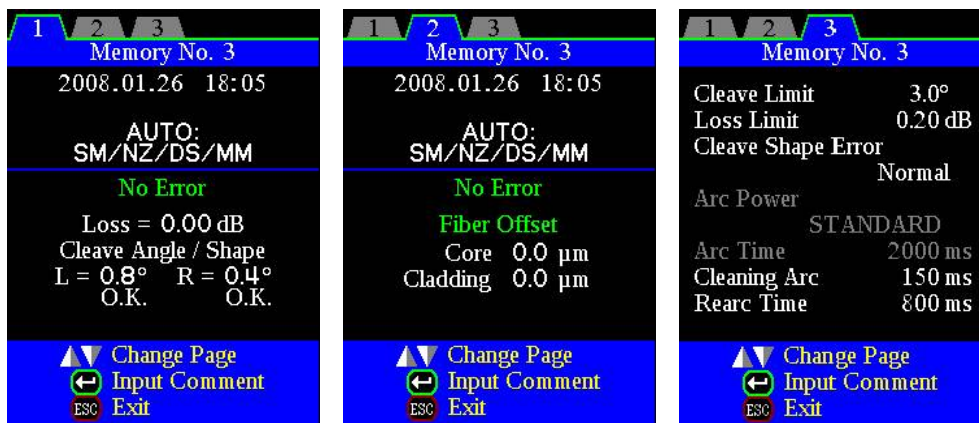

Others



## 3-1. List of Splice Results

Splicing results stored in the memory can be displayed. Comments can be added or edited.



- Memory Data can be download by USB. Refer to instruction manual of “FSM Data Connection”.

### How to display the splice Result data

- (1) Select [Memory] in [Splice Menu].
- (2) Select [List of Splice Results] and press **Enter** key to display [List of Splice Results] Menu.
- (3) Select memory number by moving cursor to a specific memory number and press **Enter** key. The selected splicing result is displayed.  
It can jump to press **Menu** key in [Splice Result] Menu to display [Jump /Remove] screen. Select the oldest data or Latest data by pressing **Up/Down** Arrow key.
- (4) The selected splicing result is displayed. For adding or editing comments, press **Enter** key to display [Input Comment] screen.

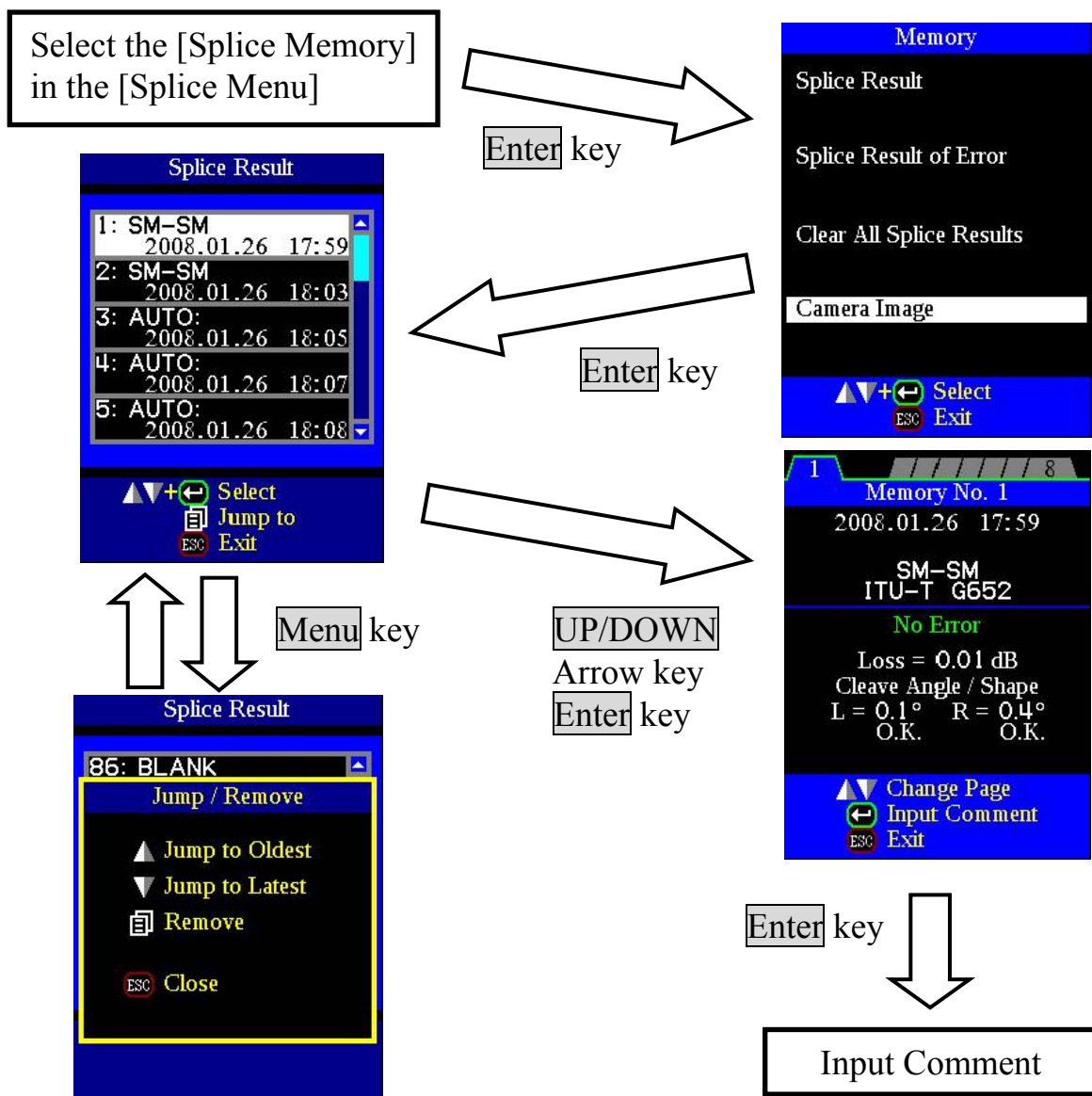

# Splice Menu

## How to Clear the Splice Results data

- (1) Press **Menu** key in [Splice Result] Menu.
- (2) Press **Menu** key in [Jump / Remove] Menu.
- (3) The memory can be deleted by pushing **Enter** key again.
- (4) Select the memory of beginning of the range that wants to delete by **Enter** key.
- (5) Select the memory of ending of the range that wants to delete by **Up/Down** arrow key.
- (6) Press the **Enter** key to decide the range. And press the Enter key to delete the memory.

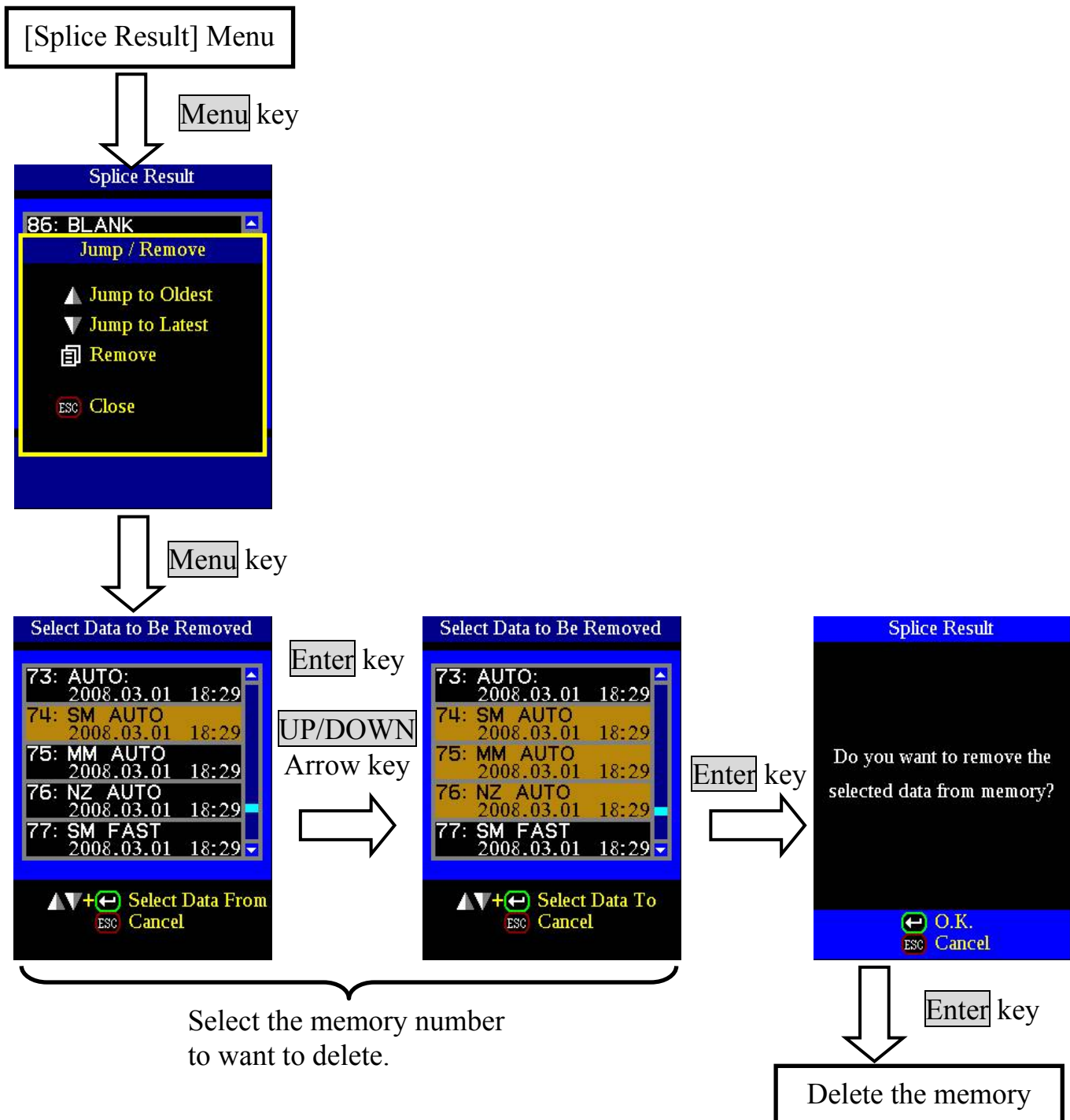

## 3-2. Splice Result of Error

Only splice result with the error is sorted out among Splice Result and displayed. The method of the display and the deletion is the same as "List of Splice Results".

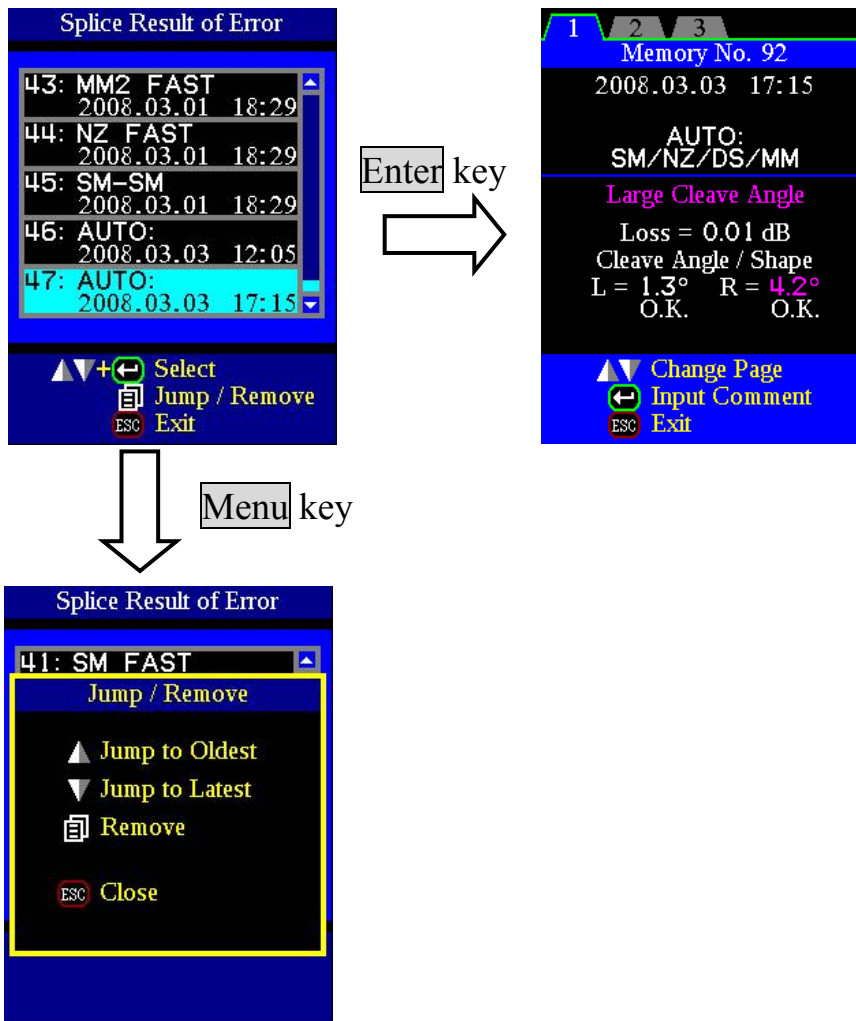

## 3-3. Clear All Splice Results

The all splicing results can be cleared at once.

- (1) Move cursor to [Clear All Splice Result] in Memory Menu. And Press the **Enter** Key.
- (2) Press **Enter** key to display [Clear All Splice Result].

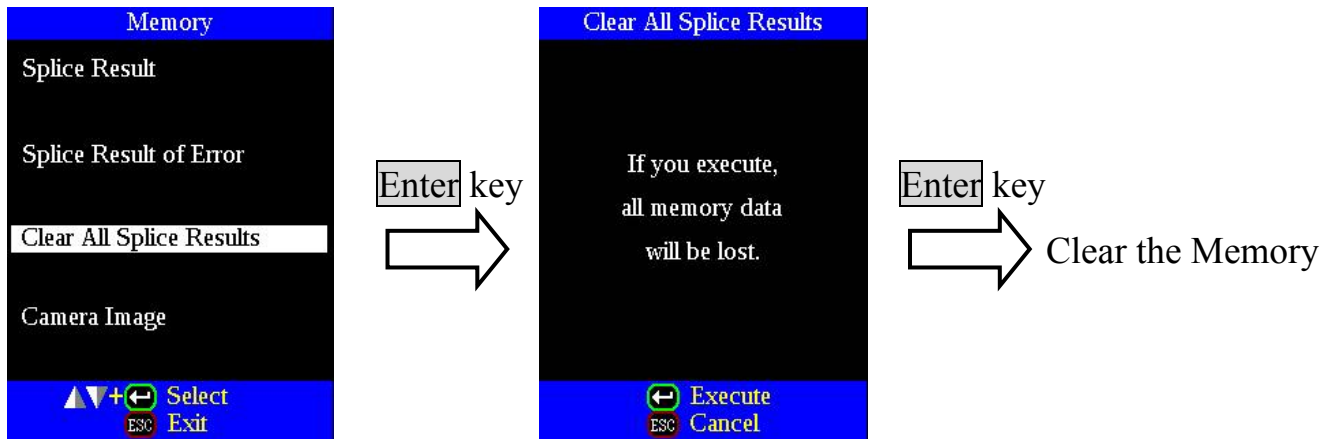

# Splice Menu

## 3-4. Camera Image

This function is to store the fiber image after splice or error occurred. Total 8 images can be stored.

- (1) Select [Memory] in [Splice Menu].
- (2) Select [Camera Image] and press **Enter** key to display [Camera Image] Menu.

### How to store the Camera Image Data

Select [No Image] by moving cursor to a specific memory number and press **Enter** key. The fiber image data is stored.



- Max number of image storage is 8, and the image cannot be over-written, so delete some images to store new images..

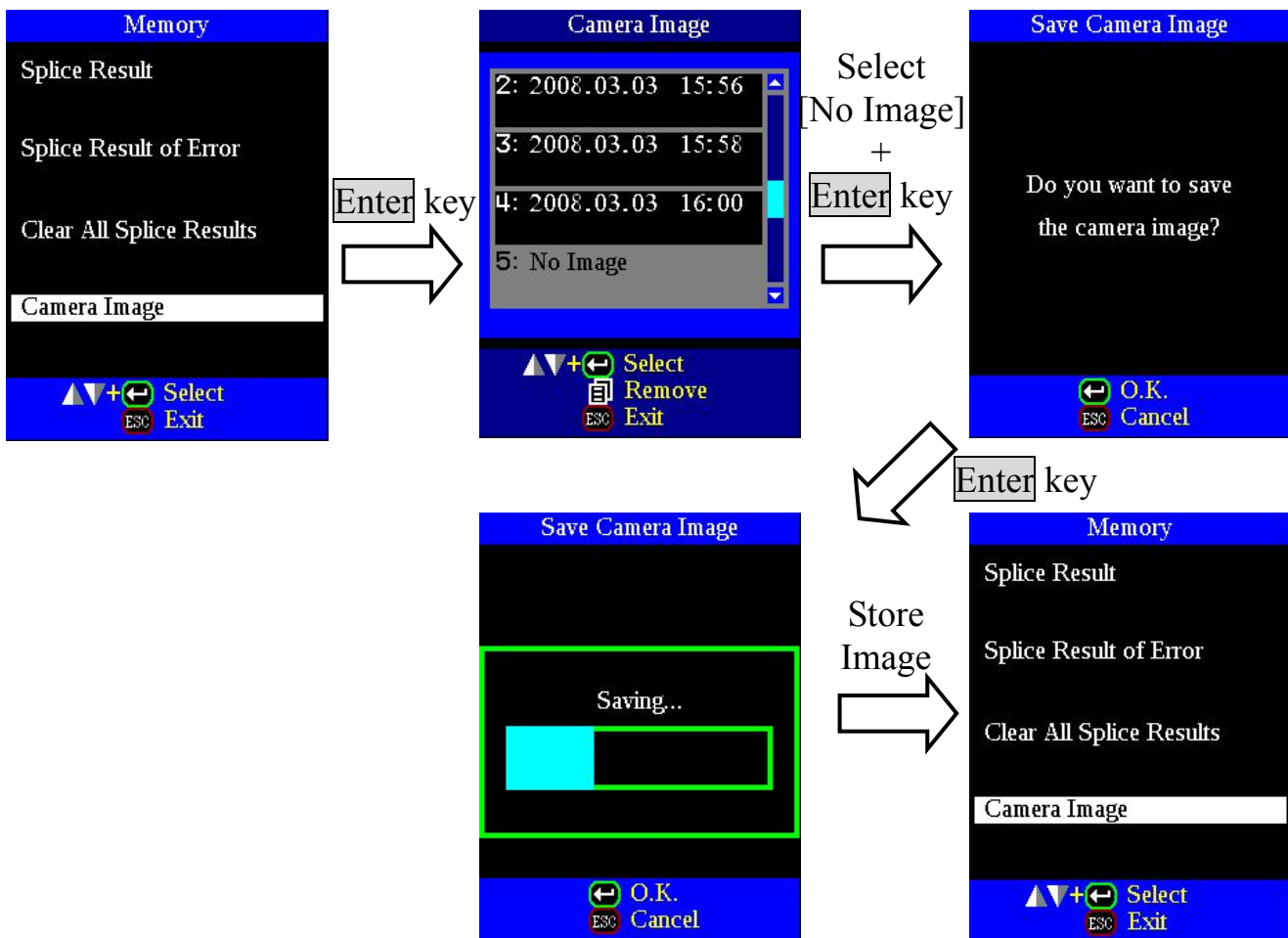



## How to display Camera Image Data

Select memory number by moving cursor to a specific memory number and press **Enter** key. The fiber image data is displayed.

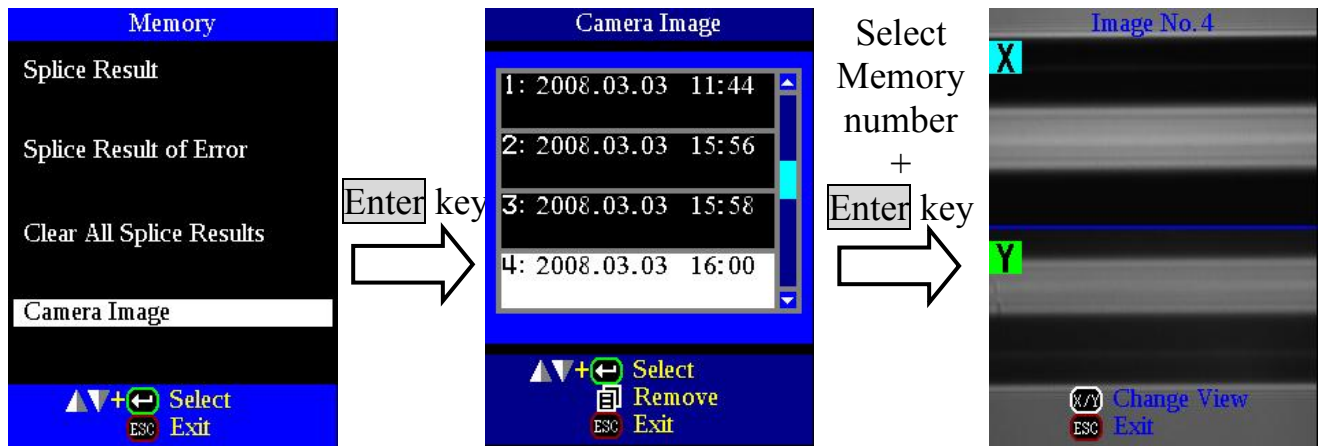

## How to delete Camera Image Data

Select the number in [Camera Image] and press the **Menu** key. The confirmation screen is displayed and **Enter** key.

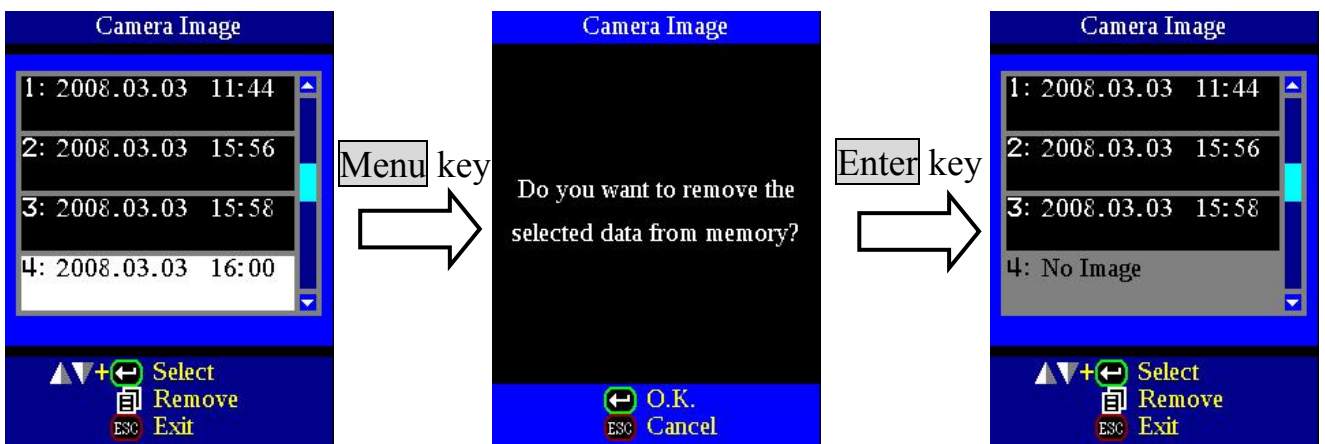

## 4. Splice Memory Comment

The splicing result is automatically stored in memory when **SET** or **RESET** is pressed upon completion of the splice at the [Finish] screen, or when the wind protector is opened upon completion of the splice at the [Finish] screen.

Once a certain comment is inputted, the same comment is inputted into subsequent splice results. To change comments, see page 68 [How to input Mode Title / Comment / Password] how to input the comment.

At the time of shipment from factory, the no comment is inputted.

# Heater Menu

## 1. Heater Mode

There are 30 user-programmable heating modes. Select one best suitable for the protection sleeve used.

Each tube-heating mode is optimized for a type of Fujikura protection sleeve. These modes can be found in database area for reference. Copy the appropriate one and paste it to the user-programmable area. The operator can edit the user-programmable modes.

Data Base

Parameter	Description
60mm	For standard 60mm protection sleeve, Such as Fujikura FP-03 or FP-03M protection sleeves.
60Ny8	For standard 60mm protection sleeve, Such as Fujikura FP-03 or FP-03M protection sleeves. Note : Cleave length 8mm.
40mm	For standard 40mm protection sleeves, Such as Fujikura FP-03 (L=40).
45mmC	For 45mm micro sleeves, such as Fujikura FPS01-900-45.
34mmC	For 34mm micro sleeves, such as Fujikura FPS01-900-34.
25mmC	For 25mm micro sleeves, such as Fujikura FPS01-900-25.
20mmC	For 20mm micro sleeves, such as Fujikura FPS01-900-20.
40mmB	For 40mm micro sleeves, such as Fujikura FPS01-400-40.
34mmB	For 34mm micro sleeves, such as Fujikura FPS01-400-34.
25mmB	For 25mm micro sleeves, such as Fujikura FPS01-400-25.
20mmB	For 20mm micro sleeves, such as Fujikura FPS01-400-20.

## 1-1. Selecting Heater mode

Select the heater mode most suitable for the protection sleeve to be used.

- (1) Press **Menu** key in [READY], [PAUSE1], [PAUSE2], [FINISH] state and press **Menu** key to display [Heater Menu].

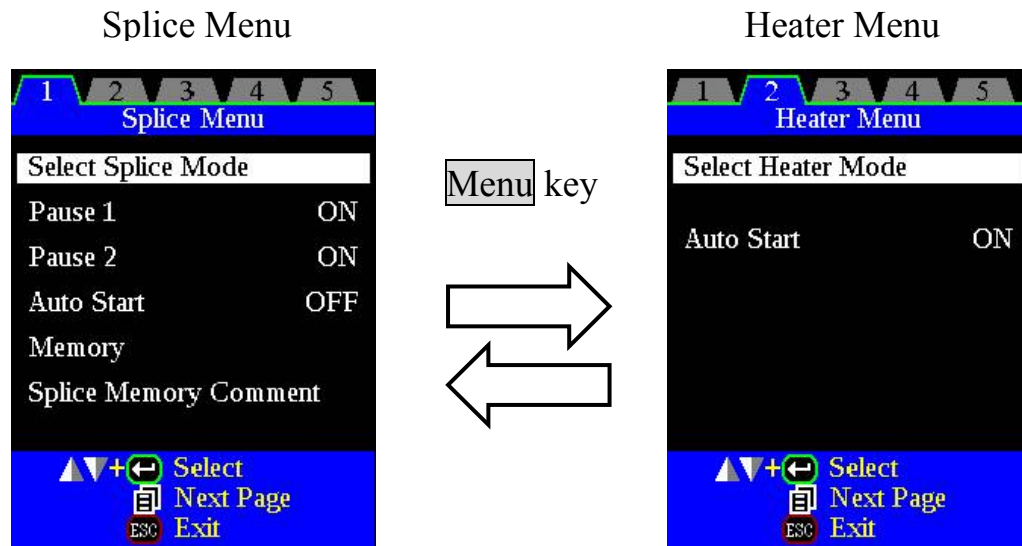

- (2) Select [Select Heater Mode] in [Heater Menu]. [Select Heater Mode] menu is displayed.
- (3) Move cursor by pressing **Up/Down** Arrow key and press **Enter** key to select a heater mode.

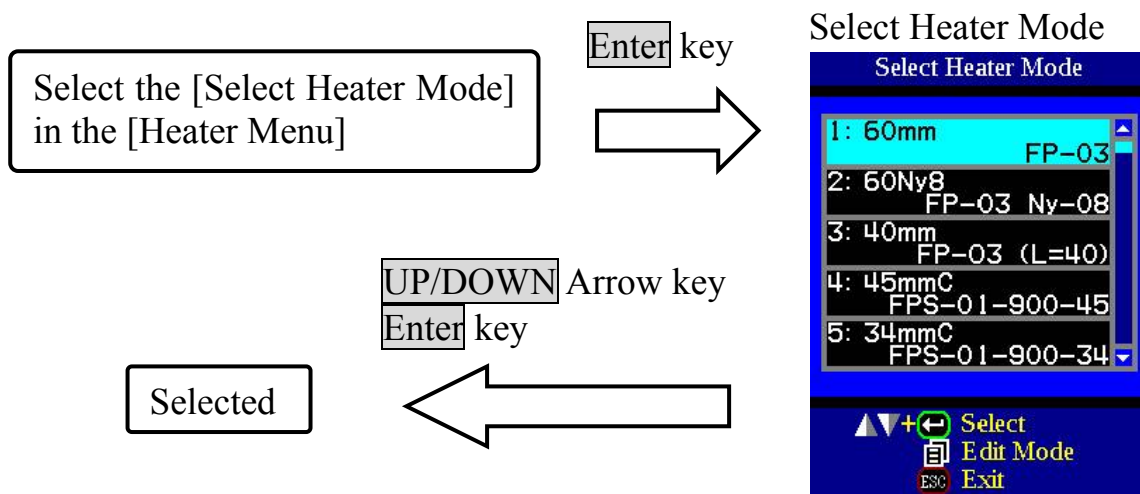

# Heater Menu

## 1-2. *ferring or editing Heater Mode*

Tube-heating conditions stored in heater mode can be edited or changed.

- (1) Move cursor and select a mode to be edited in [Select Heater Mode] menu. Press **Menu** key to display [Edit Heater Mode] menu.
- (2) Press **Up/Down** Arrow keys to move cursor to a parameter to be changed, then press **Enter** key to enter.
- (3) Change value by pressing **Up/Down** key, then press **Enter** key to enter.

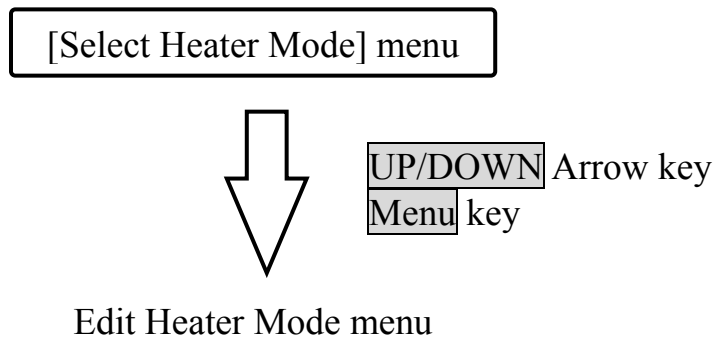

## Heater mode parameters

Parameter	Description
Sleeve type	Sets sleeve type. List of all heating modes are displayed. Select a mode in the list and this is copied to a user-programmable mode.
Mode Title1	Title of a heater mode that is displayed in the lower right part of the monitor during the splicing/heating process. Max number of characters used is 5.
Mode Title2	Description of a heater mode in the [Sleeve Type] screen. Max number of characters used is 13.
Heat Time	Sets heating time from the beginning to the end (cool-down completion). Heating time is automatically adjusted with atmospheric conditions, such as ambient temperature. Heating time may be longer or shorter than [Heat time] set.
Heat Temperature	Sets heating temperature. In the case that Ny coated fiber is used with 8mm cleave length, the Ny coating may melt if [Heat Temp] is over 190 degrees Celsius.
Finish Temperature	Sets the finish temperature. When heater approaches this temperature, the buzzer beeps announcing the sleeve is cooled down and is ready to be taken out of the heater. <b>Caution</b> If the [Finish Temp] is set for over 100 degrees Celsius, the buzzer beeps before sleeve is cooled down and ready. Hot sleeves easily deform and can cause some residual stress at the splice point once the sleeve is finally cool.

## 2. Auto Start

- (1) Select [Auto Start] in [Heater Menu].
- (2) Press **Enter** key to change value.



Parameter	Description
Auto Start	If “Auto Start” is set "ON", heating starts automatically as soon as the tube heater is closed. Fibers should be prepared and placed into the tube heater in advance. Press the <b>HEAT</b> key necessary when “Auto Start” is disable.

# Setting Menu

## 1. Splice Settings

Common parameters for all the modes for splicing can be set.

- (1) Press **Menu** key in [READY], [PAUSE1], [PAUSE2], [FINISH] state and press **Menu** key to display [Setting Menu].

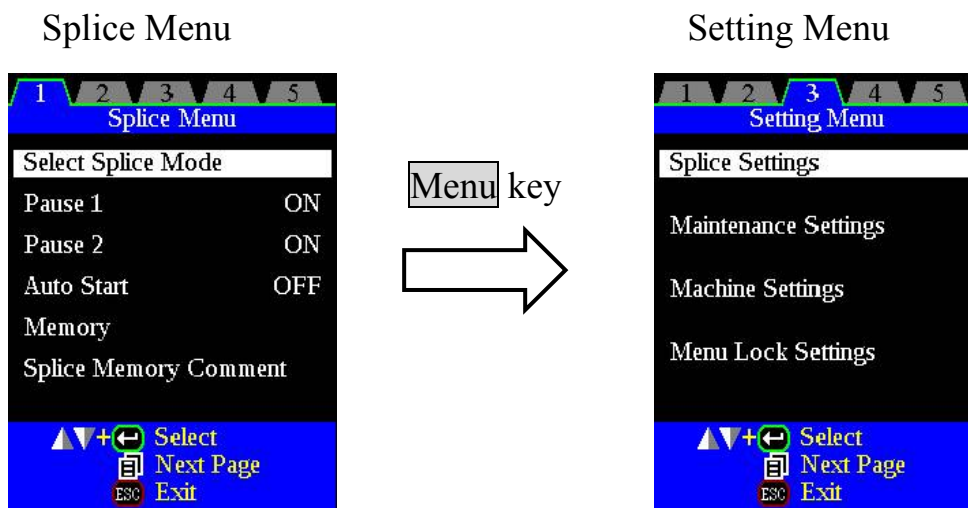

- (2) Select [Splice Settings] in [Setting Menu] to display [Splice Settings] menu.
- (3) Select a parameter to be changed.
- (4) Press **Enter** key to change values.

Select the [Splice Settings]  
in the [Setting Menu]

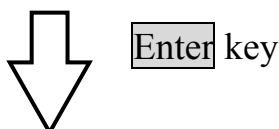

Splice Settings



Parameter	Description
<b>Ignore Splice Error</b>	
Loss	Setting to “Disable” prevents the splicer from normally finishing its operation even if the message “Loss Error,” “Bubble Error,” “Fat Error” “Thin Error” or “Fiber Angle Error” is disregarded.
Bubble	
Fat	
Thin	
Fiber Angle	
Cleave	Setting to “Disable” prevents the splicer from continuing a splice even if the message “Cleave Angle Error” is disregarded.
<b>Fiber Image on Screen</b>	
Gapset	Sets the method of displaying the fiber image on the screen during Splicing operation. X : Enlarged display of X-axis image Y : Enlarged display of Y-axis image X▲▼Y : Composite display vertically of X-axis and Y-axis images DATA : Display result of cleave angle and offset.
Pause1	
Align	
Pause2	
Arc	
Estimate	
Finish	
<b>Others</b>	
Auto Fiber Forward	If “Auto Fiber Forward” is set to “ON”, fibers are automatically moved closer to gapset as soon as wind protector is closed.
Max. Num. Of Rearcs	The re-arcng process sometimes improves the splice loss, but sometimes worsens it. Re-arcng decreases the splice strength. With this function, it is possible to limit the number of re-arcs or to disable re-arc discharge.

# Setting Menu

## 2. Maintenance Settings

Available to set the parameters about warning and maintenance item.

Electrode	
Electrode Caution	When the number of splices made exceeds 1,000, the caution message prompting for electrode replacement is displayed when the power is turned on. When the number of splices exceeds 2,000, the caution message changes to the warning message. The number of arc discharges at which to start these messages is set in this field.
Electrode Warning	
Arc Calibration	
Cleave Limit	Sets the threshold of cleave angle error in the [Arc Calibration].
Max Number of Tests	Sets the number of tests to finish the [Arc Calibration] with “Test Finished” message.
Maintenance Date	
Last Maintenance	The date of last maintenance and the scheduled date for next maintenance are entered in the respective fields. This information is displayed on the [Maintenance Info.] screen. Refer to the next section.
Next Maintenance	



## 3. Machine Settings

- (1) Select [Machine Settings] in [Setting Menu].
- (2) Select a parameter to be changed.

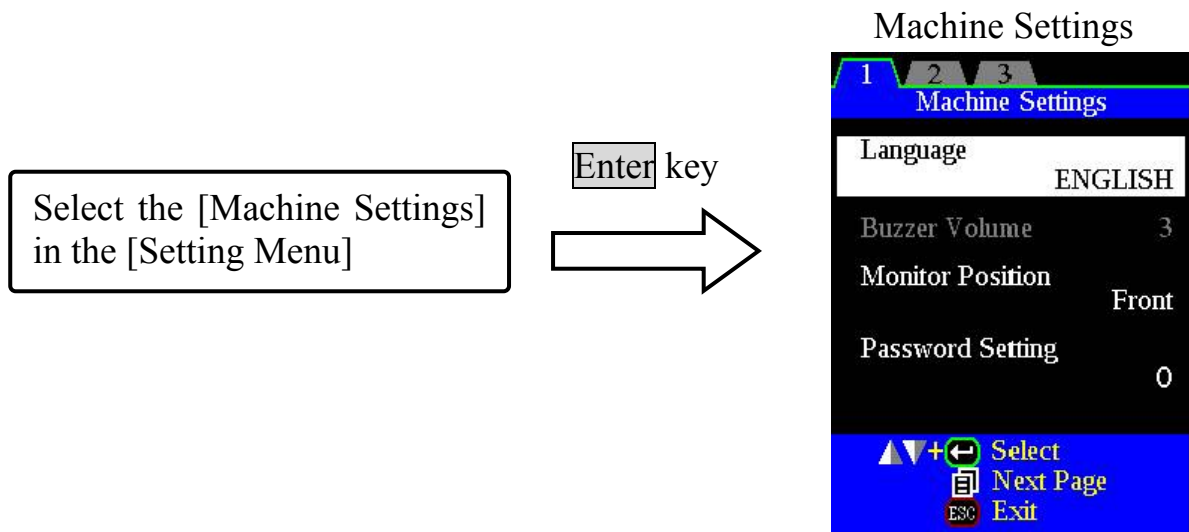

Parameter	Description
Language	Sets a language to be displayed on the screen. Select a language to be displayed. The language that can be displayed changes by a software version and region code.
Buzzer Volume	Sets the sound volume of the buzzer.
Monitor Position	Sets the operational direction of splicer. [Front] is for front monitor operation. [Rear] is for rear monitor operation. [Auto] is switched to front monitor operation or rear monitor operation automatically. Refer to next page for detail.
Password Setting	Changes the password to access the [Splice Settings], [Maintenance Settings], [Machine Settings], [Menu Lock Settings] menus. Maximum Characters : 7 At the time of shipment from factory, the password is set at "0". In the event you have forgotten your password, contact the distributor.

# Setting Menu

## 3-1. Change of Operating Direction

The splicer is shipped from the factory with settings for the “Monitor Front” operation style. This can be changed to “Monitor Rear” operation style. The sheath clamp direction can also be changed for the selected style. When [Monitor Position] is changed, the direction of the four arrow keys is reversed.

### Changing monitor position

- (1) Change monitor angle. The Monitor image direction changes automatically when [Auto] is selected. See previous page for detail.



Monitor Front



Monitor Rear

- (2) Change direction of sheath clamps.

1. Loosen and remove screws with a driver, and remove sheath clamp.



Loosen the screw



Remove the sheath clamp

2. Remove the other sheath clamp by same way.

3. Attach the opposite sheath clamps and tightens screws.



Attach the sheath clamp (opposite)

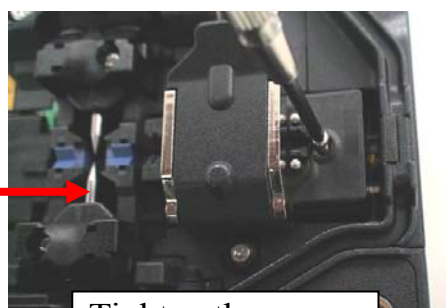

Tighten the screw

## 3-2. Power Save function in Machine Settings

This function is important for energy conservation. If the power saving function is not set during battery pack use, the number of splice cycles will be decreased. The splicer automatically identifies the type of power supply unit. In addition, it can program an independent power saving setting. Utilizing these features enables automatic turning on or off of the power saving function after detecting the power supply units.

### Setting Power Save

- (1) Select [Machine Settings] in the [Setting Menu] to display [Turn-Off Time] setting menu.
- (2) Change value of [Monitor] Turn-Off Time and [Splicer] Turn-Off Time.

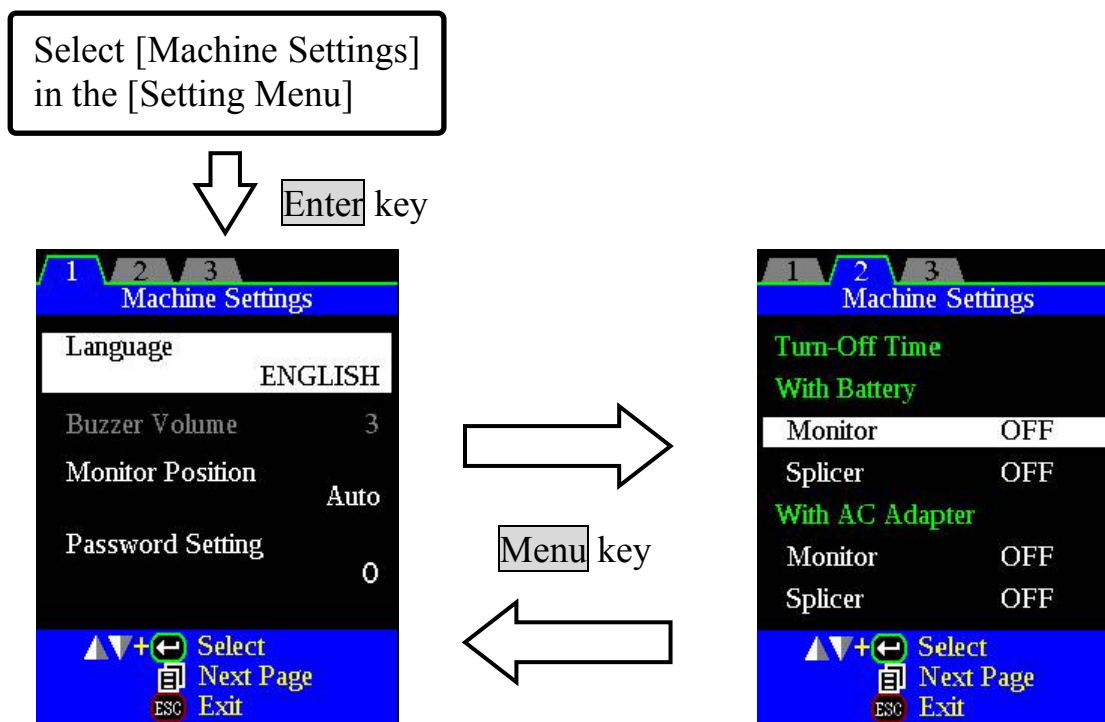

Parameter	Descriptions
Monitor	Setting this function turns off the power supply to the LCD monitor if the splicer performs no operation after a certain period of time. Always set this function to a specific shutdown time when using the battery pack. When the power supply to the LCD monitor turns off, the LED near the <span style="border: 1px solid black; padding: 1px;">ON/OFF</span> key blinks. Pressing any key turns on the LCD monitor.
Splicer	Automatically turns off the power supply to the splicer if it performs no operation for a certain period of time. The function serves to prevent the battery capacity from running low if the splicer is left on for an extended period of time.

# Setting Menu

## 3-3. Power On Option in Machine Settings

Set Opening title and Password Lock function

Parameter	Descriptions
Opening Title1	Sets the message to be displayed when the power is turned on. Max. number of characters : 15 (Opening Title1)
Opening Title2	15 (Opening Title2) To edit Title, see page [Title] on how to input title.
Password Boot Lock From	<p>From selected date set and beyond, a password is required at splicer boot up in order to operate it.</p>  <p style="text-align: right; border: 1px solid black; padding: 2px;">Input Date</p> <p>Password is common to the Password for [Maintenance Settings] (Page 86).</p>
Quick Boot	If set to "ON", the splicer boots up quickly.

## 4. Menu Lock Settings

(1) Select [Menu Lock Settings] in the [Setting Menu]. Password input screen is displayed.

(2) Input Password.

See page 68 [How to input Mode Title / Comment / Password] on how to input password.

(3) Change a parameter value.

Used for Administrator to limit operator from selecting or changing certain functions.

Parameter	Descriptions
<b>Splice Mode</b>	
Edit	Setting to “Disable” prevents unauthorized editing and selecting of splice modes.
Select	
<b>Heater Mode</b>	
Edit	Setting to “Disable” prevents unauthorized editing and selecting of heater modes.
Select	
<b>Machine Settings</b>	
Buzzer Volume	Setting to “Disable” prevents unauthorized.
<b>Turn-Off Time</b>	
Monitor	Setting to “Disable” prevents unauthorized changing of the power saving function.
Splicer	
<b>Splice Settings</b>	
Edit	[Splice Setting] Menu cannot be edited if this is set to “Disable”.
<b>Splice Memory</b>	
Clear	Setting to “Disable” prevents unauthorized erasing of splice result data on the memory.
Cancel Recording	Setting to “Disable” prevents unauthorized canceling of recording of splice result data on the [FINISH] screen.
<b>Maintenance Menu</b>	
Replace Electrodes	Setting to “Disable” prevents various functions related to maintenance.
Stabilize Electrodes	
Clear Arc Count	
Battery Discharge	
Set Calendar	
Diagnostic Test	
Dust Check	
Arc Calibration	
Motor Calibration	
Motor Drive	

# Maintenance Menu

The splicer has the ability to perform routine maintenance. This section describes how to use the maintenance menu.

- (1) Press **Menu** key in [READY], [PAUSE1], [PAUSE2], [FINISH] state. Press **Menu** key to display [Maintenance Menu1], [Maintenance Menu2].
- (2) Select a function to perform.

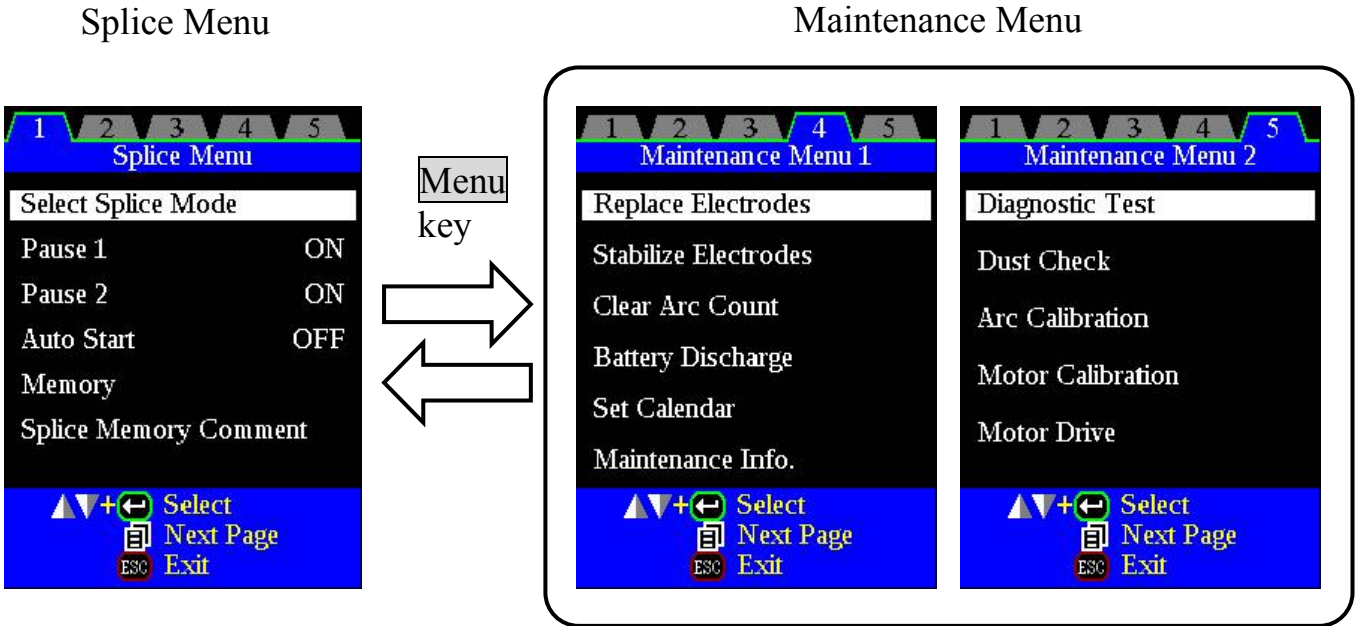

## 1. Replace Electrodes

It is recommended that the electrodes be replaced after 1,000 arc discharges. When the number of arc discharges reaches a count of 2,000, a message prompting to replace the electrodes is displayed immediately after turning on the power. Using the electrodes without a replacement will result in greater splice loss and reduced splice strength. In certain high strength applications, cleaning the electrodes can be beneficial. Contact your distributor for information on these applications.

### Replacement Procedure

- (1) Execute [Replace Electrode] in [Maintenance Menu 1].
- (2) Instruction messages will appear on the screen to turn off the power. Press and hold **Enter** key till the LED color changes from green to red.
- (3) Remove the old electrodes.

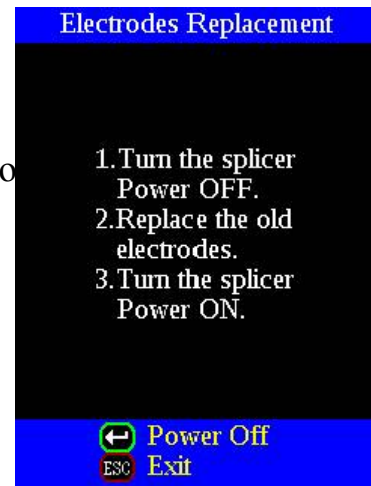

To remove and replace the electrodes:

- (i) Loosen screw located on electrode cover.
- (ii) Take electrode out of electrode cover. (Electrode is fit in electrode cover)

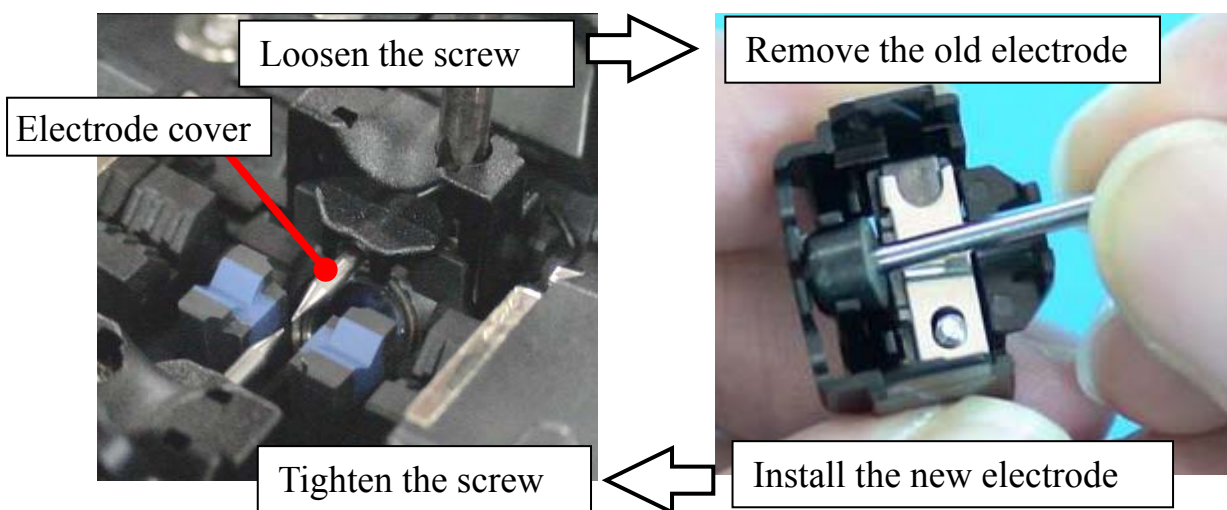

- (4) Clean the new electrodes with alcohol-impregnated clean gauze or lint-free tissue and install them in the splicer.
  - (i) Fit the electrode in the electrode cover.
  - (ii) Place the electrode cover on the splicer and tighten screw.



• Apply tightening torque of 2kgf-cm when tightening screw to fix electrode cover.

## Maintenance Menu

- (5) Turn on the power, prepare and load fibers into the splicer and press **Enter** key. After executing the arc calibration, the splicer will repeat arc discharge 45 times in succession to stabilize the electrodes.
- (6) Upon completion of repeated arc discharge, the splicer executes an arc calibration again. The operator should repeat arc calibration until the “Test Finish” message appears. For details of the arc calibration process, see page 84.

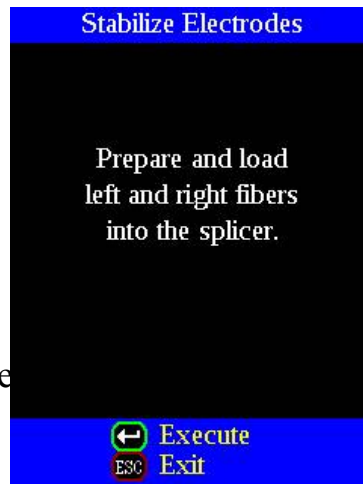

### 2. Stabilize Electrodes

In the event of sudden change in environmental conditions, etc., the arc power sometimes becomes unstable, resulting in higher splice loss. Especially when the splicer is moved from lower altitudes to higher altitudes, it takes time for the arc power to stabilize. In this case, stabilizing electrodes will expedite the process of making the arc power stable. If many tests are needed until the “Test OK” message appears in [Arc Calibration], use this function as well.

#### Operation Procedure

- (1) Select the [Stabilize Electrodes].
- (2) Set prepared fibers in both sides of the splicer as in the case of splicing.
- (3) Press **Enter** key and the splicer begins to stabilize the electrodes in the following ways:
  - Repeats short arc discharge four times to measure the arc position.
  - Performs [Arc calibration] to calibrate the arc power.
  - Perform 45-cycle continuous discharge to stabilize the electrodes.
- (4) After completing stabilization, always perform an additional [Arc Calibration].

### 3. Clear Arc Count

This function enables the stored number of arc discharges to be reset.

- (1) Select the [Clear Arc Count].
- (2) As the confirmation screen “Is it OK to clear?” appears, press **Enter** key to clear.



- This function is included in the [Replace Electrodes] function.
- The number of arc discharges in the “Total Arc Count” field displayed on the [Maintenance Info.] screen cannot be reset.



## 4. Battery Discharge

The battery pack (BTR-08) uses Ni-MH cells. If the battery pack is recharged repeatedly even though a sufficient capacity still remains, a memory effect would make it seem as if the battery capacity has decreased. If such a phenomenon occurs, execute [Battery Discharge] to reduce the remaining capacity to zero. Then, recharge the battery pack to restore the capacity. It is recommended that complete discharge of the battery pack should be performed once in a half year.

- If the splicer is left in the normal power-on state, the splicer will shut down before the battery is discharged completely. Therefore, it is necessary to use the [Battery Discharge] function to discharge the battery pack completely.
- The power saving function turns off automatically during [Battery Discharge].

### Operation Procedure

- (1) Insert the battery pack inside the splicer that is intended to discharge completely, and turn on the power.
- (2) Change the screen from [Main Menu] to [Maintenance Menu] and execute [Battery Discharge].
- (3) The [Battery Discharge] screen is displayed, and the remaining battery voltage is indicated.
- (4) Upon completion of full discharge, the buzzer sounds and the power turn off.

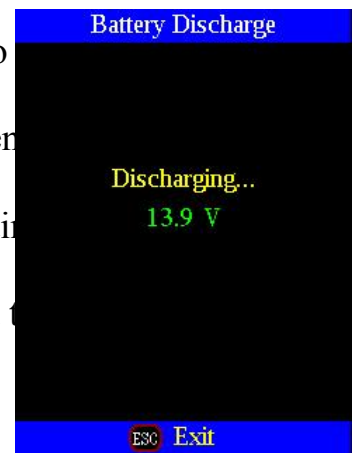

- If the battery pack is almost fully charged, it will take a significant amount of time to discharge it completely. It is recommended that this function be used after considerable time of use when the capacity is low.

- (5) Recharge the battery pack.

# Maintenance Menu

## 5. Set Calendar

This function sets the date and time in the calendar incorporated in the splicer.

### Operation Procedure

- (1) Select the [Set Calendar].
- (2) As the year, month, day and time are displayed, press **Menu** key to move the cursor to the parameters, and press **Up/Down** Arrow key to adjust numerical values.
- (3) After completion of calendar setting, press **Enter** key. The date and time are stored.



## 6. Maintenance Info.

Select the [Maintenance Info]. The following information is displayed.

Parameter	Description
Serial Num.	Displays the serial number of the splicer.
ROM Version	Displays the version number of the software.
Arc Count	Displays the number of arc discharges after electrode replacement. Performing the function [Replace Electrodes] or [Clear Arc Count] resets this parameter to zero.
Total Count	Displays the total number of arc discharges.
Last Maintenance	Displays the date of last maintenance.
Next Maintenance	Displays the scheduled date of next maintenance.

To enter the date, see page 86 [Maintenance Settings].

## 7. Diagnostic Test Function

The FSM-60S has a built in diagnostic test feature that allows the operator to perform a simple one step evaluation of splicer performance covering several different critical variables. Perform this function in the event of splicer operation trouble.

### Operation Procedure

- (1) Select the [Diagnostic Test] in the [Maintenance Menu 2] and execute [Diagnostic Test]. The following checks will be made.

	Check Item	Description
1	LED Check	Measures and adjusts the brightness of the illumination LED.
2	Motor Check	Check the Motor Limit Sensor.
3	Dust Check	Checks the optical path for dust or dirt and judges whether they disturb fiber observation. If contamination exists, this function indicates the location.
4	Motor Calibration	Automatically calibrates the 6 Motor Speeds.
5	Arc Calibration	Automatically calibrates the arc power factor and fiber splicing position.
6	I/O Port Check	Checks for normal operation of the input and output terminals of the internal circuit.
7	Memory Check	Checks the memory of the internal circuit.



- Before the start of the test, remove the fibers from the splicer.
- When item 2 (dust check) is completed, prepare and load the fibers into the splicer and press **Enter** key.

- (2) Upon completion of all checks and adjustments, a list of results is displayed. If the dust check result is not good, clean the objective lenses. In the case that cleaning cannot eliminate contamination, there is a possibility that the contamination may have entered the inside of the optical path. Please contact your distributor for additional instructions.

The dust check and Motor Calibration functions exist as independent instructions in [Maintenance Menu 2]. It is possible to execute them independently.

## 8. Dust Check

The splicer observes fibers through image processing. Dust or contaminants on the cameras, lenses and wind protector mirrors disturbs normal observation of fibers and may result in improper splicing. This function checks the optical path for the presence or absence of contaminants and judges whether they cause trouble for fiber splicing.

### **Operation Procedure**

- (1) Select the [Dust Check] in the [Maintenance Menu 2].
- (2) If fibers are set in the splicer, remove them and press Enter key again. The splicer begins the dust check.
- (3) The message “Now Checking” is displayed in the middle of the screen. After observation, the location of contamination judged as a potential problem blinks. If contamination is discovered, clean the wind protector mirrors and objective lenses and redo [Dust Check]. See page 52 the section of [Maintenance of Splicing Quality] for cleaning instructions.
- (4) Press to finish dust check.



- In case you have cleaned or replaced the wind protector mirrors, and have cleaned the objective lenses, and dirt or dust still remain, contact your distributor.

## 9. Arc Calibration

Atmospheric conditions such as temperature, humidity, and pressure are constantly changing, which creates variability in the arc temperature. This splicer is equipped with temperature and pressure sensors that are used in a constant feedback monitoring control system to regulate the arc power at a constant level.

Changes in arc power due to electrode wear and glass adhesion cannot be corrected automatically. Also, the center position of arc discharge sometimes shifts to the left or right. In this case, the fiber splicing position has to be shifted in relation to the arc discharge center. It is necessary to perform an arc power calibration to eliminate both of these issues.

- Arc calibration is performed automatically using [AUTO] mode only. So arc calibration does not have to be performed when splicing in this mode.
- Performing the [Arc Calibration] function changes the arc power “factor” value. The factor value is used in the algorithm program for all splicing. The arc power value will not change in the splice modes.

### Operation procedure

- (1) Select [Arc Calibration] in [Maintenance Menu 2] to display Arc Calibration screen.
- (2) Set prepared fibers in the splicer.

- Use standard SM or DS or MM fiber for arc calibration.
- Use well prepared fibers for arc calibration. Dust on the fiber surface affects arc calibration.

- (3) The following is performed after pressing **Enter** key.
  1. Calculating the Arc center  
Arc discharge is performed without fibers in the view screen to detect the center of arc discharge and adjust the gapset position.
  2. Cleaning arc discharge  
The left and right fibers move forward. The splicer performs the cleaning arc discharge.
  3. Gap setting  
The left and right fibers further move forward and stop at the specified gap setting position.
  4. Arc discharge  
The splicer performs an arc discharge without stuffing the fibers together. The gap between the left and right fibers is melted back by the arc discharge.
  5. Measurement result  
After the arc discharge, the melt-back amounts of the left and right fibers are measured by image processing circuits in the splicer.

# Maintenance Menu



- Cleave angle threshold does not link to the parameter "Cleave Limit" in splicing modes. Cleave angle threshold is independently set for arc calibration. See page 84 [Splice Settings] to change cleave angle threshold.

## “Good” message

Arc power and splicing position calibration are successfully completed. Press **Escape** key to exit.

## “Not Adequate” message

Arc power and splicing position calibration are completed but further calibration is strongly recommended, as the change from the previous arc calibration is too large. Press **Enter** key to perform arc calibration, or **Escape** key to exit even though arc calibration is not completed.

Select the [Arc Calibration]  
in the [Maintenance Menu]



**Enter** key

### Arc Calibration

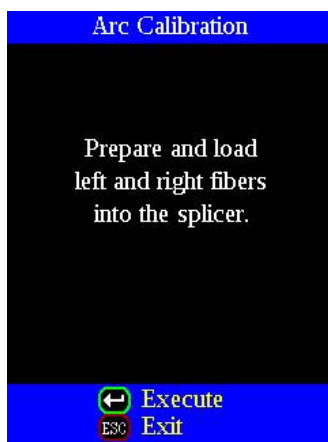

**Enter** key

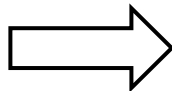

### Arc Calibration Result

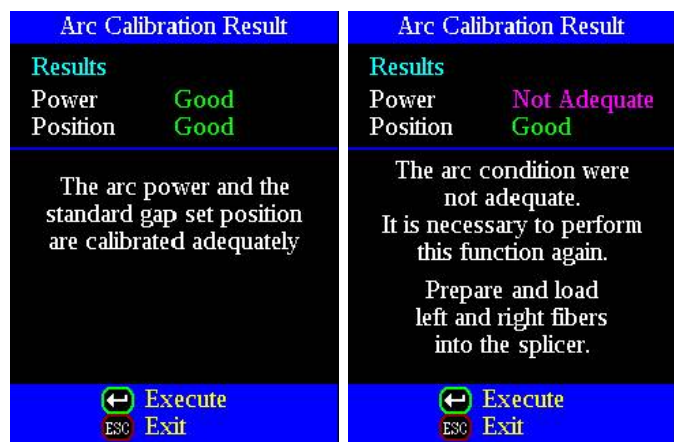

- In some cases, multiple iterations of arc calibration are needed until the calibration process is successfully completed and the "Test Finish" message is displayed. Arc calibration can be considered almost completed if multiple iterations are completed without receiving the message.
- Number threshold can be set so that "Test Finish" message is displayed after specific number of arc calibrations are performed. See page 84 [Splice Settings] for detail.

## 10. Motor Calibration

Motors were adjusted at the factory before shipping. However, settings could change due to various reasons. This function automatically calibrates the speed of all six motors.

### Operation Procedure

- (1) Select the [Motor Calibration] in the [Maintenance Menu 2].
- (2) Load prepared fibers in the splicer and press **Enter** key.
- (3) Speeds for all motors are automatically calibrated. Upon completion, [Maintenance Menu 2] is displayed.



• Perform this function when "Fat" or "Thin" error has occurred, or fiber aligning or focusing is taking too much time.

## 11. Motor Drive

The six motors incorporated in the splicer can be manually operated individually. In the course of splicing, the motors can also be operated by calling this menu in the [PAUSE1], [PAUSE2] or [FINISH] state.

- (1) Select the [Motor Drive].
- (2) Pressing **Menu** key changes motor selection. The name of the selected motor is displayed in the upper section of the screen.
- (3) Press **Up/Down** Arrow key to drive the motor in the desired direction.

Motor	<b>Up</b> Arrow key	<b>Down</b> Arrow key
ZL/ZR	Forward.	Backward.
X/Y	Upward.	Downward.
Focus X Focus Y	Lens moves nearer fiber.	Lens moves away from fiber.



- When the motor reaches the limit of the operating range, the buzzer sounds and the motor stops. Press the opposite arrow key to reverse and move the motor again.
- Display messages can be erased by pressing **Enter** key. The message can be displayed by pressing **Enter** key again.
- If you finish this operation by pressing **RESET** key, the motor will return to the reset position. To finish the operation with the motor held in the adjusted position, press **Escape** key.
- If the motor is moved too much with respect to the spliced fiber, the fiber may break.

## Error Message List

Press **Enter** when an error is shown on the monitor. The [HELP] screen displays the following:

- If error does not have an error code, such as “Cleave Shape NG”, the keystrokes are displayed with information explaining what each keystroke does if pressed.
- If error has an error code, additional information according to the Error Code and Message is displayed.

Follow the solution precisely as shown in the list below. If it is not possible to eliminate the problem, the splicer may require service by a qualified service center. Consult your distributor with the following information:

- Model name of the splicer
- Serial number of the splicer
- Error message
- Error code (if shown)
- Situation when the error occurs

Error Message	Reason	Solution
L-Too Long Fiber	<ul style="list-style-type: none"> <li>• The fiber end-face is placed on the electrode centerline, or beyond it.</li> </ul>	<ul style="list-style-type: none"> <li>• Press <b>RESET</b>, and set the fiber end-face between the electrode centerline and the V-groove edge.</li> </ul>
R-Too Long Fiber	<ul style="list-style-type: none"> <li>• The cleave length (bare fiber part) is too long.</li> </ul>	<ul style="list-style-type: none"> <li>• Confirm the setting position of the stripped fiber end on the fiber cleaver. Check the cleave length.</li> </ul>
LR-Too LongFiber	<ul style="list-style-type: none"> <li>• Dust or dirt is on the objective lens or the wind protector mirror.</li> </ul>	<ul style="list-style-type: none"> <li>• Execute the [Dust Check]. Clean the lens or the mirror when dust or dirt exists.</li> </ul>
X-Dark BackGround	Dust or dirt is on the objective lens or the wind protector mirror.	Execute the [Dust Check]. Clean the lens or the mirror if dust or dirt exists.
Y-Dark BackGround		
X-Dark BackGround	The LED or Camera might be damaged.	Consult your distributor.
Y-Dark BackGround		



Error Message	Reason	Solution
L-Too Dusty Fiber	<ul style="list-style-type: none"> <li>• Dust or dirt is on the fiber surface.</li> <li>• Dust or dirt is on the objective lens or the wind protector mirror.</li> <li>• [Cleaning Arc] time is too short or “OFF.”</li> </ul>	<ul style="list-style-type: none"> <li>• Completely prepare the fiber again (strip, clean and cleave).</li> <li>• Execute the [Dust Check]. Clean the lens or the mirror if dust or dirt exists.</li> <li>• Set the [Cleaning Arc] time to “30ms.” When splicing carbon coated fibers, set to “100ms.”</li> </ul>
R-Too Dusty Fiber	<ul style="list-style-type: none"> <li>• Splicing indistinct core fibers with the SM or DS modes.</li> <li>• [Align] is set to “Core” to splice indistinct core fibers when using other splice modes.</li> <li>• [Focus] is incorrectly set when using other splice modes.</li> </ul>	<ul style="list-style-type: none"> <li>• Use the MM mode to splice indistinct core fibers (i.e. MM fiber).</li> <li>• Set [Align] to “Clad” to splice indistinct core fibers (i.e. MM fiber).</li> <li>• Set [Focus] to “Edge” to splice indistinct core fibers (i.e. MM fiber). To splice distinct core fibers, “Auto” or the correct focus value should be entered.</li> </ul>

## Error Message List

Error Message	Reason	Solution
ZL Motor Overrun (Forward)	<ul style="list-style-type: none"> <li>The fiber is set too far back and does not reach the splice point.</li> <li>The fiber is not set correctly at the bottom of the V-groove. The fiber is not located in the Camera's field of view.</li> <li>The cleave length (bare fiber part) is too short.</li> </ul>	<ul style="list-style-type: none"> <li>Press <b>RESET</b> key, re-position the fiber again with the end-face closer to the electrodes.</li> <li>Press <b>RESET</b> key, and set the fiber again to seat it correctly at the bottom of the V-groove.</li> <li>Confirm the setting position of the stripped fiber end on the fiber cleaver. Check the cleave length.</li> </ul>
ZR Motor Overrun (Forward)		
ZL Motor Overrun (Backward)	The taper speed or taper time is set too high.	Adjust the taper parameters in the splice mode.
ZR Motor Overrun (Backward)	Only occurs in manual motor operation.	
X motor Overrun (Forward)	The fiber is not set correctly at the bottom of the V-groove. The fiber is offset too far and it exceeds the X or Y motor range.	Press <b>RESET</b> key and re-position the fiber again to seat it correctly at the bottom of the V-groove.
X motor Overrun (Backward)		
Y Motor Overrun (Forward)		
Y Motor Overrun (Backward)		

## Error Message List

Error Message	Reason	Solution
Focus X Motor Overrun (Forward)	<ul style="list-style-type: none"> <li>• The fiber is not set correctly at the bottom of the V-groove. The fiber position is out of focus range.</li> <li>• Dust or dirt is on the fiber surface resulting in focus failure.</li> <li>• Dust or dirt is on the objective lens or the wind protector mirror.</li> </ul>	<ul style="list-style-type: none"> <li>• Press <b>RESET</b> key, and re-position the fiber again to seat it correctly at the bottom of the V-groove.</li> <li>• Completely prepare the fiber again (strip, clean and cleave).</li> <li>• Execute the [Dust Check]. Clean the lens or mirror if dust or dirt exists.</li> </ul>
Focus X Motor Overrun (Backward)		
Focus Y Motor Overrun (Forward)		
Focus Y Motor Overrun (Backward)		
Close Cover	Unable to start splicing when the wind protector opens.	The splicer automatically starts splicing after closing the wind protector.
Cover Open	The wind protector is opened during splicing operation.	Press <b>RESET</b> key after closing the wind protector.
ZL Motor Trouble	Motor might be damaged.	Consult your distributor.
ZR Motor Trouble		
X-Motor Trouble		
Y-Motor Trouble		
Focus X Motor Trouble		
Focus Y Motor Trouble		

## Error Message List

Error Message	Reason	Solution
Cannot detect fiber in AUTO mode	Dust or dirt is on the fiber surface.	Completely prepare the fiber again (strip, clean and cleave). Select the suitable splice mode. Pressing the
	The left and right fiber types are different.	<b>SET</b> key cancels the error and continues the splice operation.
	Splicing non-standard fibers.	The AUTO mode can identify standard SM, DS, MM and NZDS fiber only.
Strong Arc Power	Unable to calibrate due to strong arc.	Replace the electrodes by using the [Electrode Replace] function. If this does not eliminate the problem, consult your distributor.
Weak Arc Power	Unable to calibrate due to weak arc.	
Too Left Arc	Unable to calibrate due to poor arc field position (too far left).	
Too Right Arc	Unable to calibrate due to poor arc field position (too far right).	
Fiber Separation	The fiber stuff amount is insufficient.	Execute the [Motor Calibration] function. If using other splice modes, check the [Overlap] setting in the splice mode.
	The pre-fuse power or pre-fuse time is set too high.	Check the [Prefuse Power] and [Prefuse Time] settings in the splice mode.
L-Bad Fiber Position	The fiber is not set correctly at the bottom of the V-groove.	Press <b>RESET</b> key, and re-position the fiber again to seat it correctly at the bottom of the V-groove.
R-Bad Fiber Position		
No Arc Discharge	Arc Discharge did not occur.	<ul style="list-style-type: none"> <li>• Assure the electrodes are in proper position.</li> <li>• Replace the electrodes.</li> <li>• Consult your distributor.</li> </ul>

## Error Message List

Error Message	Reason	Solution
Large Cleave Angle	Bad fiber end-face.	Check the condition of the fiber cleaver. If the blade is worn, rotate the blade to a new position.
	[Cleave Limit] is set too low.	Increase the [Cleave Limit] to an adequate limit.
Large Fiber Angle	[Core Angle Limit] is set too low.	The splicer measures the core angle only when using other splice modes. Increase the [Core Angle Limit] to an adequate limit. (1.0 degree is standard)
	Dust or dirt is on the V-groove or the clamp chip.	Clean the V-groove and clamp chip, and set the fibers again. If the error occurs again, strip, clean and cleave the fibers.
	Bad fiber end-face.	Check the condition of fiber cleaver. If the blade is worn, rotate the blade to a new position.
Cleave Shape NG	Bad fiber end-face.	Check the condition of fiber cleaver. If the blade is worn, rotate the blade to a new position.
Arc Discharge Delayed	Arc Discharge is delayed	<ul style="list-style-type: none"> <li>• Assure the electrodes are in proper position.</li> <li>• Execute the [Stabilize Electrode] function.</li> <li>• Replace the electrodes.</li> </ul>
Thin Fiber	Inadequate arc power	Calibrate the arc power with the [Arc Calibration] function.
	Prefuse power or time is set too high	If using the Other mode, adjust or initialize [Prefuse Power] or [Prefuse Time] settings. For normal splice mode, the prefuse is fixed and cannot be adjusted.
	Insufficient [Overlap] setting	<ul style="list-style-type: none"> <li>• If using the Other mode, adjust or initialize [Overlap] setting. For normal splice mode, the overlap is fixed and cannot be adjusted.</li> </ul>
Fat Fiber	Too much [Overlap] setting	<ul style="list-style-type: none"> <li>• Execute [Motor Calibration] function in the maintenance menu to calibrate the stuff amount.</li> </ul>
Too Tapering Fiber	Too much fiber taper.	If using the taper splice function, the error message may appear meaning the fiber is tapered too much.
Bubble	Bad fiber end-face.	Check the condition of fiber cleaver. When the blade is worn, rotate the blade.
	Prefuse power or time is set too low	If using the Other mode, adjust or initialize [Prefuse Power] or [Prefuse Time] settings. For normal splice mode, the prefuse is fixed and cannot be adjusted.
Large Dust Burn	Bad fiber end-face.	Check the condition of the fiber cleaver. If the blade is worn, rotate the blade to a new position.
	[Cleaning Arc] time is too short or "OFF."	Dust still present after cleaning fiber or cleaning arc. Clean fiber thoroughly or Increase [Cleaning Arc Time]

## Error Message List

Error Message	Reason	Solution
High Estimated Loss	Insufficient fiber cleaning.	Dust or dirt on the fiber surface results in bad splice loss and low tensile strength. <ul style="list-style-type: none"> <li>• Clean the fiber surface sufficiently.</li> <li>• Do not clean the fiber after cleaving to prevent dust on the fiber end-face.</li> <li>• Avoid any contact with the fiber end-face.</li> </ul>
	Bad fiber end-face.	<ul style="list-style-type: none"> <li>• Check the condition of fiber cleaver. If the blade is worn, rotate the blade to a new position.</li> <li>• Confirm the [Cleave Limit] setting. 2.0° or less is recommended.</li> </ul>
	Dust or dirt is on the V-groove or the clamp chip.	Dust or dirt on the V-groove or clamp chip causes poor fiber movement during fiber stuffing. Clean them periodically.
	Dust or dirt is on the lens or mirror	Execute the [Dust Check]. If dust or dirt exists, clean the lenses or mirrors.
	Bad electrode condition.	Replace the electrodes if they appear worn (rounded tip shape), dirty or bent.
	Inadequate arc power.	Calibrate the arc power with the [Arc Calibration] function.
	Using unsuitable splice mode	Select a suitable splice mode for the fibers to be spliced.
	[Loss Limit] is set too low.	Increase [Loss Limit] to an adequate limit.
	Fibers were spliced after Error 08 was canceled.	Select the appropriate splice mode from the Other modes.
	Inadequate arc parameters in other splice modes	Confirm the arc parameters are adequate to splice the fibers.
Inadequate estimating parameters in Other mode	Confirm the estimating parameters are adequate to estimate the loss. The MFD mismatch function does not work for certain types of specialty fibers. In these cases, set the [MFD Mismatch] to “OFF”.	

## *Error Message List*

Error Message	Reason	Solution
There is dust after executing Dust Check function	Dirt or dust exists in optical path.	<ul style="list-style-type: none"><li>• Clean the wind protector mirrors by referring page 53. If it is not possible to remove the dirt or dust on the mirror, replace the wind protector mirror by referring page 56.</li><li>• Clean the objective lenses by referring page 54.</li><li>• When the above processes cannot remove the dirt or dust, consult your distributor.</li></ul>
X Camera Y Camera Trouble	The Camera may be damaged.	Consult your distributor.
Heater Oven Trouble	Heater does not heat.	Consult your distributor.
Communication error	Broken the internal device	Consult your distributor.
Temperature Sensor NG	Temperature Sensor may be damaged.	Consult your distributor.

# *Questions and Troubleshooting*

---

## *1. Power Supply*

### (1) Power does not turn off when pressing **ON/OFF** key

- Press and hold the key until the LED color changes from green to red.

### (2) Few splices can be made with a fully charged battery pack

- If the power saving function is not enabled, battery power degrades quicker. See page 87 [Machine Settings]. Always enable it to conserve power usage.
- If degradation appears (memory effect), or if the battery pack is stored for an extended period of time, completely discharge it. See page 95 [Battery Discharge]. After discharge completion, recharge the battery pack.
- The battery pack has reached the end of its service life. Install a new battery pack.
- The battery pack uses chemical reaction. The capacity decreases at low temperature, especially at lower than 0 degree C.
- At high altitude, the arc discharge current is increased. In this condition, battery power degrades quicker due to large power consumption.
- The AC adapter does not charge the battery pack correctly. See next item.

### (3) “CHARGE” LED on AC adapter blinks during battery recharge

- The battery pack has a fault or has reached the end of its service life. Install a new battery pack. If the LED blinks again after install, contact your distributor.

### (4) Method to change the power saving function settings

- See page 87 [Machine Settings] function.

### (5) Battery indicator is not displayed / Power saving function does not work

- If using the AC adapter, the function does not work.
- Battery pack indicator on the battery pack does not work correctly.

### (6) Incorrect indication of battery indicator

- The indicator display serves as a reference only.
- Battery Pack Indicator on the battery does not work correctly.

### (7) “POWER ON” LED on AC adapter blinks

- ADC-11 has a cooling fan. If the cooling fan stops running, the “POWER ON” LED will blink. Contact your distributor.



## 2. Splicing Operation

### (1) Error message appears on monitor

- See page 102 [Error Message List].

### (2) Inconsistent splice loss / High splice loss

- Clean the V-grooves, fiber clamps, wind protector mirrors, and objective lenses. See page 52 [Maintenance of Splicing Quality].
- Replace the electrodes. See page 57 [Electrode Replacement].
- See page 102 to the “High Estimated Loss” error message section in the [Error Message List].
- If the fiber has curl or bend memory, position the fiber so the crown (curve) of the memory is turned upward.
- The splice loss varies according to the cleave angle, arc conditions and fiber cleanliness.
- If the splice loss is still too high or inconsistent after performing the above-mentioned remedies, contact your distributor. Regular service (at least once a year) is recommended to maintain high splicing quality.

### (3) Confirmation of splicing procedures

- See page 26 [Basic Operation].

### (4) Monitor suddenly turned off

- The power saving function is automatically enabled when using a battery pack. The splicer switches to the power saving state after an extended period of splicer inactivity. Press any key to return to the normal state. To change the length of time before the splicer switches to the power saving state, See page 87 [Machine Settings] on.

### (5) Splicer power suddenly turned off without “Low Battery” message

- The power saving function is automatically enabled when using a battery pack. The splicer turns the splicer power off after an extended period of splicer inactivity. Press **ON/OFF** key to turn on the splicer again. To change the length of time before the splicer turns the splicer power off, see page 87 [Machine Settings] function.

### (6) Method to initialize arc condition of Splice mode

- See page 63 [Referring or editing splice mode].

### (7) Method to change error thresholds for Cleave angle, Splice loss and Fiber angle

- See page 63 [Referring or editing splice mode] when using the SM, NZ, MM or AUTO mode. There is no fiber angle threshold in these modes.
- See page 63 [Referring or editing splice mode] when using the OTHER mode.

## *Questions and Troubleshooting*

---

### (8) Error message can be over-ridden

- See page 84 [Splice Settings] to not allow error message override.

### (9) Unable to change Arc Power and Arc Time

- The settings cannot be changed in SM, NZ, MM or AUTO modes.
- Performing [Arc Calibration] maintains adequate arc power in these modes.
- If using the “Other Mode”, the Arc Power and Arc Time may be locked by administrator, preventing them from being changed.

### (10) Method to set Pause

- See page 58 [Splice Menu].

### (11) Method to display Cleave Angle, Fiber Angle and Core / Cladding Offsets

- See page 84 [Splice Settings]. The fiber angle is not displayable in the SM, DS, MM or AUTO mode.

### (12) Incorrect splice mode selected and used in AUTO mode

- The AUTO mode can detect only standard SM, DS, MM and NZDS fibers. When splicing specialty fibers, the AUTO mode may identify them incorrectly. For other possible troubles in AUTO mode, see page 58 [Splice Mode].

### (13) Mismatch between Estimated splice loss and Actual splice loss

- The estimated loss is a calculated loss, so it can be used for reference only.
- The optical components of the splicer may need to be cleaned.
- When splicing specialty fibers, adjust [MFD-L], [MFD-R], [Core Step] and [Core Curvature]. When splicing dissimilar fibers, adjust also [Min. Loss] and [MFD Mismatch]. To adjust these parameters, refer to parameter settings of the other splice modes stored in the database area.

### (14) If using the “Other Mode”, Re-arc discharge becomes intermittent

- Set the [Arc2 OFF Time] to “OFF”. See page 63 [Referring or editing splice mode].

### (15) Method to operate Focus motor after splicing

- Use the [Motor Drive] function in [Maintenance Menu] while in [PAUSE1], [PAUSE2] or [Finish] states. Press Up/Down Arrow key to adjust the focus.

### (16) Realignment performed after manual aligning in Pause2

- To disable the realignment, see page 84 [Splice Settings]. An alternative option is to use the manual splice mode. See page 69 [Manual Splice Mode].

### 3. Tube-heating Operation

#### (1) Fiber protection sleeve does not shrink completely

- Extend the heating time. See page 80 [Heater Mode].

#### (2) Heater LED on panel keyboard blinks

- Pressing the **HEAT** key during heating causes the LED to blink. The tube heater is turned off if the **HEAT** key is pressed again. If, after 2 seconds have gone by without pressing the **HEAT** key again, the LED stays on continuously and the heater returns to its normal state. The LED will turn off when the heat cycle is completed.
- If the heating temperature does not reach its inputted setting, the LED blinks and the alarm sounds. If this happens, contact your distributor.

#### (3) Fiber protection sleeve adhered to heating plate after shrinking

- Use a cotton swab or a similar soft tip object to push and remove the sleeve.

#### (4) Method to initialize heating condition of Heater mode

- See page 82 [Heater Mode].

#### (5) Method to cancel heating process

- **RESET** key does not cancel the heater. Press **HEAT** key twice to cancel the heating process.

### 4. Supervising

#### (1) What functions can be disabled

- See page 91 [Menu Lock Settings].

#### (2) Method to lock “selection” or “editing” of Splice or Heater mode

- See page 91 [Menu Lock Settings].

#### (3) Method to set parameters of Splice or Heater mode from a PC

- To set or change the parameters, contact your distributor.

#### (4) Forgot password

- Contact your distributor.

# Questions and Troubleshooting

---

## 5. Other Functions

### (1) Method to hide messages on [READY] screen

- Change the fiber image from X/Y view to X magnified view or Y magnified view by pressing **[X/Y]** key.

### (2) Too many repetitions until “Test Finish” indicated in [Arc Calibration]

- The splicer needs to repeat the arc calibration after replacing the electrodes or when the environmental conditions change drastically (page 87). The number of arc calibrations can be set to a specific amount. When the splicer completes the set amount of calibrations, it indicates “Test Finish”. However, this does not mean it is completely calibrated.

### (3) “Test Finish” is never indicated after many repetitions in [Arc Calibration]

- Execute [Stabilize Electrodes] function in [Maintenance Menu]. If the splicer still does not indicate “Test Finish”, replace the electrodes. See [Replace Electrodes] section.

### (4) No arc power change after [Arc Calibration]

- An internal factor is calibrated and adjusted for the specific arc power selected. The displayed arc power in each splice mode does not change.
- The calibration results affect all splice modes.

### (4) Method to input different comments after each splice in splice results data

- See page 79 [Splice Memory Comment].

### (5) Method to download splice results from splicer to PC

- Contact your distributor.

Blank Page

### **6. Guarantee**

#### 1. Guarantee period and limits

If the splicer becomes out of order within one year from the date of delivery, we will repair it free of charge. However, note that repairs will be charged for the following cases regardless of the guarantee period:

- (1) Trouble or damage due to natural disaster.
- (2) Trouble or damage due to mishandling.
- (3) Trouble or damage due to handling in disregard of the operating procedures or instructions described in the instruction manual.
- (4) Consumable items (discharge electrodes etc.)
- (5) Trouble or damage due to abnormal voltage supply.

Most cases of damage to the AC adapter from an abnormal power supply occur within the warranty period. The specification of AC input voltage is up to AC240V (340V-peak). For this reason, Fujikura Ltd. will provide a warranty replacement of the AC adapter only one time. In a second AC adapter is damaged during the warranty period, Fujikura Ltd. will not replace it free of charge.

#### 2. Before shipping the splicer

Please consult your distributor first.

#### 3. Necessary information needed for repair

Include documentation with the splicer informing us of the details listed below.

- (1) Your full name, section, division, company, address, phone number, fax number and e-mail address.
- (2) Model name and serial number of the splicer.
- (3) Problems encountered
  - What problems did your splicer get into and when?
  - What is its present operational state?
  - The state of the monitor and the contents of the relevant error message.etc.

#### 4. Transporting the splicer

Since the splicer is a high-precision machine, always use the original carrying case for transportation and storage in order to protect it against humidity, vibration and shock. When requesting splicer repair, please send it, along with its accessories, in its original carrying case.

#### 5. Note for Repair

Please note the memory contents, such as splicing results, splice mode, etc., may be lost depending on the kind of repair.

### **7. Contact Address**

Inquiries concerning products should be made to the distributor or one of the following:

Fujikura Europe Ltd.  
C51 Barwell Business Park  
Leatherhead Road, Chessington, Surrey KT9 2NY  
England  
Tel. +44-20-8240-2000 (Service: +44-20-8240-2020)  
Fax. +44-20-8240-2010 (Service: +44-20-8240-2029)  
URL <http://www.fujikura.co.uk>

AFL Telecommunications  
260 Parkway East  
Duncan, SOUTH CAROLINA 29334  
U.S.A.  
Tel. +1-800-235-3423 (Service: +1-800-866-3602)  
Fax. +1-864-433-5560 (Service: +1-800-433-5452)  
P.O.Box 3127 Spartanburg, SC 29304-3127  
URL <http://www.AFLtele.com>

Fujikura Asia Ltd.  
460 Alexandra Road #22-01 PSA Building  
Singapore 119963  
Tel. +65-6-2711312 Fax. +65-6-2780965  
URL <http://www.fujikura.com.sg>

Fujikura Ltd.  
Optical Fiber & Equipment Department  
International Sales & Marketing  
1-5-1 Kiba, Koto-ku, Tokyo 135-8512  
Japan  
Tel. +81-3-5606-1164 Fax. +81-3-5606-1534  
URL <http://www.fujikura.co.jp>

----- End of Document -----