

## Passive Intermodulation Analyzers

### PIM Analyzer Site Type Manual



# Content

<b>Basic Safety Instructions .....</b>	<b>1</b>
Symbols and safety labels .....	6
<b>Chapter 1 Product Description .....</b>	<b>7</b>
Rosenberger PIA (Passive Intermodulation Analyzer) Site Type .....	7
Front Panel View .....	8
Front Panel Description .....	9
LCD Screen .....	13
Accessories .....	15
Standard adapters .....	15
Portable low PIM termination .....	15
<b>Chapter 2 Operating the PIM-Analyzer .....</b>	<b>16</b>
Preparation for Use .....	16
Intended Use / Operating environment .....	16
Connect test cables .....	16
Connect AC power .....	16
Manual operation .....	16
System setup .....	17
Operation mode setup .....	20
Start measurement .....	21
Software .....	24
Run PIA .....	24
System setup .....	25
Start measurement .....	31
Analyzer results .....	33
Store result and create report .....	38
Exit .....	44
Other functions .....	44
<b>Chapter 3 Application .....</b>	<b>47</b>
Measurement range .....	47
Measurement Uncertainty .....	47
Test and maintenance .....	50
Choose suitable test cables .....	50
Protect test port .....	50
Measurement example .....	52
Cable assembly measurement .....	52
Antenna measurement .....	53
Duplexer measurement .....	55
<b>Intermodulation Analyzer Technical Data .....</b>	<b>57</b>

## **Basic Safety Instructions**

### **Always read and comply with the following safety instructions!**

Rosenberger make every effort to keep the safety standards of our products up to date to offer our customers the highest possible degree of safety. Our products and the accessory equipment they require are designed, built and tested in accordance with the safety standards that apply in each case. The compliance with these standards is monitored by our quality assurance system. The product described here has been designed, built and tested in accordance with the attached EC Certificate of Conformity and has left the manufacturers plant in a condition fully complying with safety standards. To maintain this condition and to ensure safe operation, you must observe all instructions and warnings provided in this manual. If you have any questions regarding these safety instructions please contact Rosenberger to answer them.

Furthermore, it is your responsibility to use the product in an appropriate manner. This product is designed for use solely in industrial and laboratory environments or, if expressly permitted, also in the field and must not be used in any way that may cause personal injury or property damage. You are responsible if the product is used for any intention other than its designated purpose or in disregard of the manufacturer's instructions. The manufacturer shall assume no responsibility for such use of the product.

The product is used for its designated purpose if it is used in accordance with its product documentation and within its performance limits (see data sheet, documentation, the following safety instructions). Using the product requires technical skills and a basic knowledge of English. It is therefore essential that only skilled and specialized staff or thoroughly trained personnel with the required skills be allowed to use the product. If personal safety gear is required for using Rosenberger PIM Analyzer, this will be indicated at the appropriate place in the product documentation. Keep the basic safety instructions and the product documentation in a safe place and pass them on to the subsequent users.

Observing the safety instructions will help prevent personal injury or damage of any kind caused by dangerous situations. Therefore, carefully read through and adhere to the following safety instructions before and when using the product. It is also absolutely essential to observe the additional safety instructions on personal safety, for example, that appear in relevant parts of the product documentation.

### **Operating states and operating positions**

The product may be operated only under the operating conditions and in the positions specified by the manufacturer without the product's ventilation being obstructed. If the manufacturer's specifications are not observed, this can result in electric shock, fire and/or serious personal injury or death. Applicable local or national safety regulations and rules for the prevention of accidents must be observed in all work performed.

1. Never switch output power on (in manual mode or remote mode) without load or terminated DUT connected to the test port.
2. Unless otherwise specified, the following requirements apply to our products: predefined operating position is always with the housing floor facing down, IP protection 2X, pollution severity 2, over voltage category 2, max. operating altitude 2000 m above sea level, max. transport altitude 4500 m above sea level. A tolerance of:  $\pm 10\%$  shall apply to the nominal voltage and  $\pm 5\%$  to the nominal frequency.
3. Do not place the product on surfaces, vehicles, cabinets or tables that for reasons of weight or stability are unsuitable for this purpose. Always follow the manufacturers installation instructions when installing the product and fastening it to objects or structures (e.g. walls and shelves). An installation that is not carried out as described in the product documentation could result in personal injury or death.
4. Do not cover the heat sink or ventilation openings.
5. Do not place the product on heat-generating devices such as radiators or fan heaters. The ambient temperature must not exceed the maximum temperature specified in the product documentation or in the data sheet. Product overheating can cause electric shock, fire and/or serious personal injury or death.

### **Electrical safety**

If the information on electrical safety is not observed either at all to the extent necessary, electric shock, fire and/or serious personal injury or death may occur.

1. Prior to switching on the product, always ensure that the nominal voltage setting on the product matches the nominal voltage of the AC supply network. If the equipment is used at different voltages, the power fuse of the product may have to be changed accordingly.
2. In the case of products of safety class I with movable power cord and connector, operation is permitted only on sockets with an earthing contact and protective earth connection.
3. Intentionally breaking the protective earth connection either in the feed line or in the product itself is not permitted. Doing so can result in the danger of an electric shock from the product. If extension cords or connector strips are implemented, they must be checked on a regular basis to ensure that they are safe to use.
4. To disconnect the device from the AC supply network, the plug of the connecting cable is regarded as the disconnecting device. In such cases, always ensure that the power plug is easily reachable and accessible at all times (corresponding to the length of connecting cable, approx. 2 m). Functional or electronic switches are not suitable for providing disconnection from the AC supply network. If products without power switches are integrated into racks or systems, a disconnecting device must be provided at the system level.
5. Never use the product if the power cable is damaged. Check the power cable on a regular basis to ensure that it is in proper operating condition. By taking appropriate safety measures and carefully laying the power cable, you can ensure that the cable will not be damaged and that no one can be hurt by, for example, tripping over the cable or suffering an electric shock.

6. The product may be operated only from TN/TT supply networks fused with max. 16 A
7. Do not insert the plug into sockets that are dusty or dirty. Insert the plug firmly and all the way into the socket. Otherwise, sparks that result in fire and/or injuries may occur.
8. Do not overload any sockets, extension cords or connector strips; doing so can cause fire or electric shocks.
9. For measurements in circuits with voltages  $V_{rms} > 30$  V, suitable measures (e.g. appropriate measuring equipment, fusing, current limiting, electrical separation, insulation) should be taken to avoid any hazards.
10. Ensure that the connections with information technology equipment, e.g. PCs or other industrial computers, comply with the IEC60950-1 / EN60950-1 or IEC61010-1 / EN 61010-1 standards that apply in each case.
11. Unless expressly permitted, never remove the cover or any part of the housing while the product is in operation. Doing so will expose circuits and components and can lead to injuries, fire or damage to the product.
12. If a product is to be permanently installed, the connection between the PE terminal on site and the product's PE conductor must be made first before any other connection is made. The product may be installed and connected only by a licensed electrician.
13. For permanently installed equipment without built-in fuses, circuit breakers or similar protective devices, the supply circuit must be fused in such a way that anyone who has access to the product, as well as the product itself, is adequately protected from injury or damage.
14. Use suitable over voltage protection to ensure that no over voltage (such as that caused by a bolt of lightning) can reach the product. Otherwise, the person operating the product will be exposed to the danger of an electric shock.
15. Any object that is not designed to be placed in the openings of the housing must not be used for this purpose. Doing so can cause short circuits inside the product and/or electric shocks, fire or injuries.
16. Unless specified otherwise, products are not liquid-proof (see also section "Operating states and operating positions", item 1. Therefore, the equipment must be protected against penetration by liquids. If the necessary precautions are not taken, the user may suffer electric shock or the product itself may be damaged, which can also lead to personal injury.
17. Never use the product under conditions in which condensation has formed or can form in or on the product, e.g. if the product has been moved from a cold to a warm environment. Penetration by water increases the risk of electric shock.

**Operation**

1. Operating the products requires special training and intense concentration. Make sure that persons who use the products are physically, mentally and emotionally fit enough to do so; otherwise, injuries or material damage may occur. It is the responsibility of the employer/operator to select suitable personnel for operating the products.
2. Operation of the PIM analyzer can produce electromagnetic radiation. It must be made sure, that the radiation level doesn't exceed limits of national regulations. Persons with pacemakers and pregnant women are especially endangered.
3. Before you move or transport the product, read and observe the section titled "Transport".
4. Before you start processing the product mechanically and/or thermally, or before you take it apart, be sure to read and pay special attention to the section titled "Waste disposal", item 1.
5. Should a fire occur, the product may release hazardous substances (gases, fluids, etc.) that can cause health problems. Therefore, suitable measures must be taken, e.g. protective masks and protective clothing must be worn.

**Repair and service**

1. The product may be opened only by authorized, specially trained personnel. Before any work is performed on the product or before the product is opened, it must be disconnected from the AC supply network. Otherwise, personnel will be exposed to the risk of an electric shock.
2. Adjustments, replacement of parts, maintenance and repair may be performed only by electrical experts authorized by Rosenberger. Only original parts can be used for replacing safety parts (e.g. power switches, power transformers, fuses). A safety test must always be performed after safety parts have been replaced (visual inspection, PE conductor test, insulation resistance measurement, leakage current measurement, functional test). This helps ensure the continued safety of the product.

**Batteries and rechargeable batteries/cells**

If the information regarding batteries and rechargeable batteries/cells is not observed either at all or to the extent necessary, product users may be exposed to the risk of explosions, fire and/or serious personal injury, and, in some cases, death. Batteries and rechargeable batteries with alkaline electrolytes (e. g. lithium cells) must be handled in accordance with the EN 62133 standard.

1. Cells must not be taken apart or crushed.
2. Cells or batteries must not be exposed to heat or fire. Storage in direct sunlight must be avoided. Keep cells and batteries clean and dry. Clean soiled connectors using a dry, clean cloth.
3. Cells or batteries must not be short-circuited. Cells or batteries must not be stored in a box or in a drawer where they can short-circuit each other, or where they can be short-circuited by other conductive materials. Cells and batteries must not be removed from their original packaging until they are ready to be used.

4. Keep cells and batteries out of the hands of children. If a cell or a battery has been swallowed, seek medical aid immediately.
5. Cells and batteries must not be exposed to any mechanical shocks that are stronger than permitted.
6. If a cell develops a leak, the fluid must not be allowed to come into contact with the skin or eyes. If contact occurs, wash the affected area with plenty of water and seek medical aid.
7. Improperly replacing or charging cells or batteries that contain alkaline electrolytes (e.g. lithium cells) can cause explosions. Replace cells or batteries only with the matching Rosenberger type (see bill of materials) in order to ensure the safety of the product.
8. Cells and batteries must be recycled and kept separate from residual waste. Rechargeable batteries and normal batteries that contain lead, mercury or cadmium are hazardous waste. Observe the national regulations regarding waste disposal and recycling.

### **Transport**

1. The product may be very heavy. Therefore, the product must be handled with care. In some cases, the user may require a suitable means of lifting or moving the product (e.g. with a lift-truck) to avoid back or other physical injuries.
2. Handles on the products are designed exclusively to enable personnel to transport the product. It is therefore not permissible to use handles to fasten the product to or on transport equipment such as cranes, fork lifts, wagons, etc. The user is responsible for securely fastening the products to or on the means of transport or lifting. Observe the safety regulations of the manufacturer of the means of transport or lifting. Non-compliance can result in personal injury or material damage.
3. If you use the product in a vehicle, it is the sole responsibility of the driver to drive the vehicle safely and properly. The manufacturer assumes no responsibility for accidents or collisions. Never use the product in a moving vehicle if doing so could distract the driver of the vehicle. Adequately secure the product in the vehicle to prevent injuries or other damage in the event of an accident.

### **Waste disposal**

1. If products or their components are mechanically and/or thermally processed in a manner that goes beyond their intended use, hazardous substances (heavy-metal dust such as lead, beryllium, nickel) may be released. For this reason, the product may only be disassembled by specially trained personnel. Improper disassembly may be hazardous to your health. National waste disposal regulations must be observed.
2. If handling the product releases hazardous substances or fuels that must be disposed of in a special way, e.g. coolants or engine oils that must be replenished regularly, the safety instructions of the manufacturer of the hazardous substances or fuels and the applicable regional waste disposal regulations must be observed. Also observe the relevant safety instructions in the product documentation. The improper disposal of hazardous substances or fuels can cause health problems and lead to environmental damage.

## Cleaning

1. Prior to cleaning the product except the test port, disconnect it completely from the power supply (e.g. AC supply network or battery). Use a soft, non-linting cloth to clean the product. Never use chemical cleaning agents such as alcohol, acetone or diluents for cellulose lacquers.
2. Cleaning the 7/16 Test Port use pressurised air or alcohol soaked cotton swaps.

## Symbols and safety labels



Observe product documentation



Warning! Hot surface



Danger of electric shock



## Chapter 1 Product Description

### Rosenberger PIA (Passive Intermodulation Analyzer) Site Type



Fig 1-1 whole view

# Front Panel View

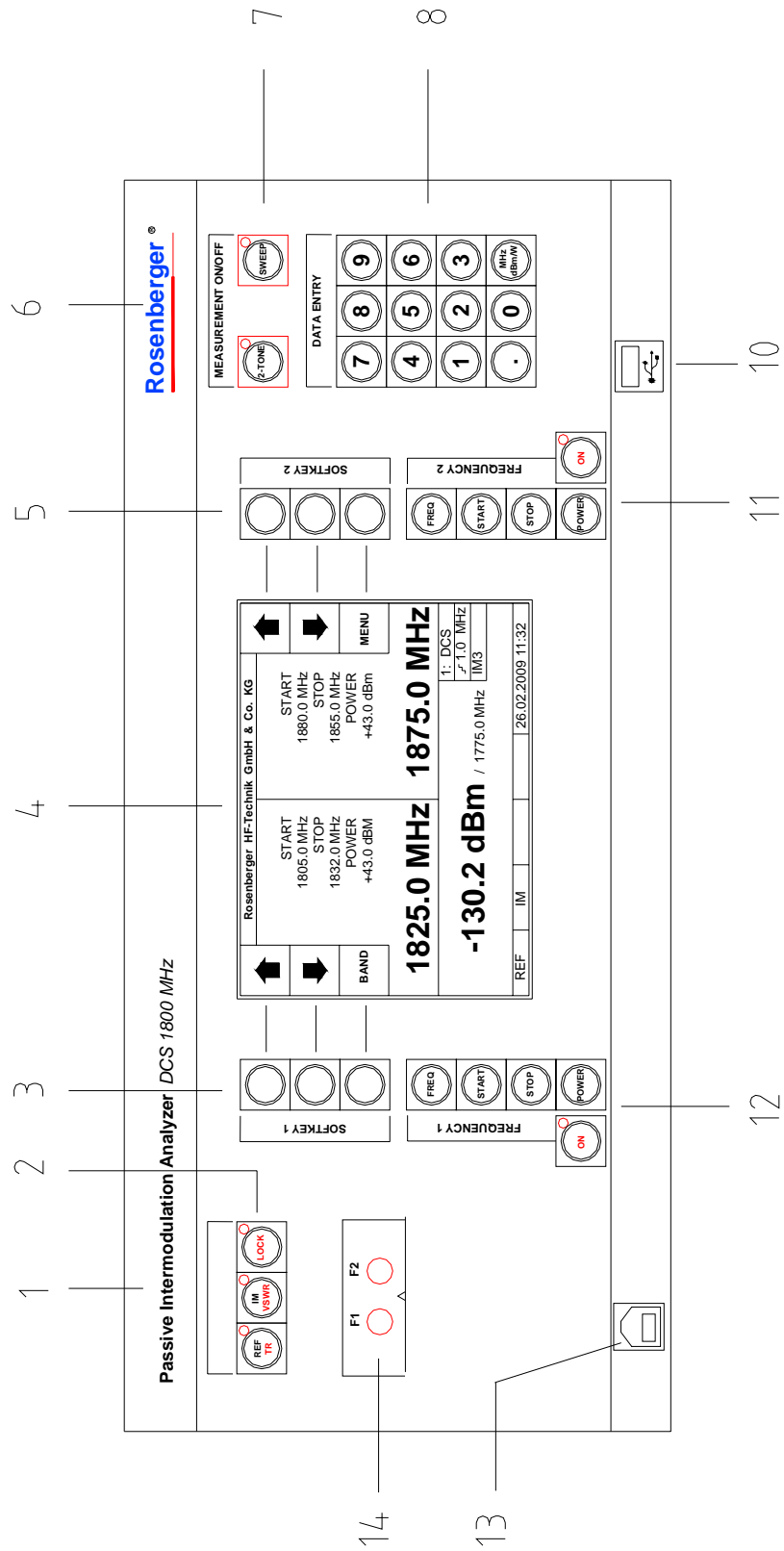

Fig 1-2 Front Panel View

## Front Panel Description

1

**Passive Intermodulation Analyzer:** Instrument description  
**i.e. DCS 1800MHz :** Operating band

2

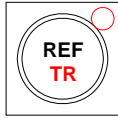

Reversed/Transmitted mode key. <sup>[1]</sup>



PIM/VSWR mode key. <sup>[2]</sup>



Panel key lock:  
 In the lock state, keys are disabled except the power switch.

3

Left soft keys

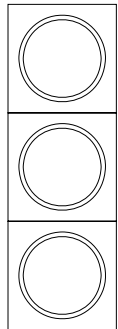

Execute the functions displayed on the left side of the screen.

4

Display

Rosenberger HF-Technik GmbH & Co. KG			
↑	START 1805.0 MHz	START 1880.0 MHz	↑
↓	STOP 1832.0 MHz	STOP 1855.0 MHz	↓
BAND	POWER +43.0 dBm	POWER +43.0 dBm	MENU
<b>1825.0 MHz</b>		<b>1875.0 MHz</b>	
<b>-130.2 dBm</b>		/ 1775.0 MHz	
		1: DCS 1.0 MHz IM3	
REF	IM	26.02.2009 11:32	

*Note[1]: Transmitted mode is only for rack type PIA not portable type.*

*Note[2]: The function requires the VSWR option.*

5

Right soft keys

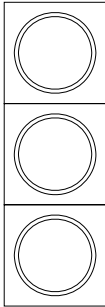

Execute the functions displayed on the right side of the screen.

6

**Rosenberger** Rosenberger logo

7



Button for measuring mode with two fixed frequencies.



Button for frequency sweep measuring mode.

8

Keypad

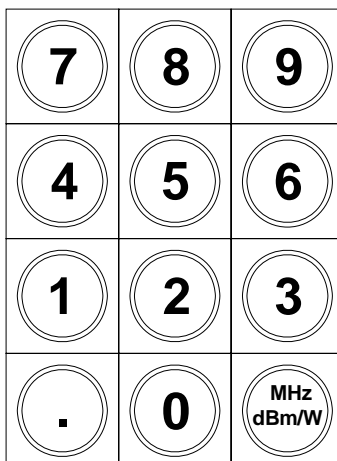

For entering a value. Use unit button (MHz / dBm) to confirm the entry.

9

Power switch, position on top of the left beam

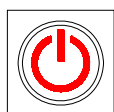

For switching the instrument on and off.

10

USB A port

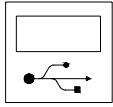

Data storing interface

11

Parameter setup for F1 channel output.

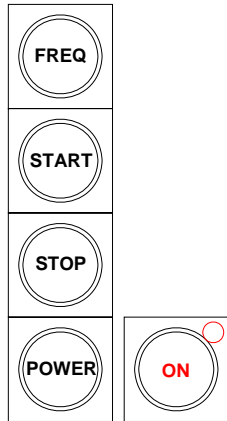

FREQ	output frequency F2 for 2-tone mode
START	start frequency for F2 in sweep mode
STOP	stop frequency for F2 in sweep mode
POWER	output power level for F2 channel
ON	switches F2 channel on

12

Parameter setup for F1 channel output.

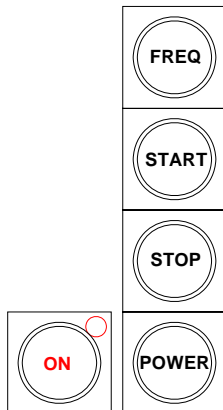

FREQ	output frequency F1 for 2-tone mode
START	start frequency for F1 in sweep mode
STOP	stop frequency for F1 in sweep mode
POWER	output power level for F1 channel
ON	switches F1 channel on

13

USB B port, for remote control by external software

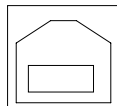

14

Signal source status indicating lamp

**F1**

**F2**



F1 and F2 power on indicator LED

15

Test port

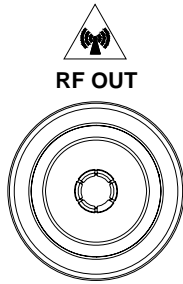

**CAUTION!**  
Do Not Touch Center Conductor  
2x +46 dBm Max

Connect DUT here.

Always have a load or DUT connected while measuring!

16

AC power source socket with fuses, on the side of the left protection beam

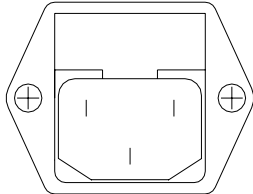

Connect the device to the AC supply by means of the supplied power cable.

The instrument is designed in line with protection class EN61010-1, it may only be connected to an earth contact type connector.

The Rosenberger PIA is fused by two fuses IEC127-F10.0H250V.

17

Fuses F2 and F3, on the right protection beam

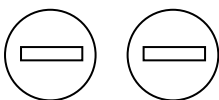

The fuses are to be replaced by two IEC127-T1.25H250V.

## LCD Screen

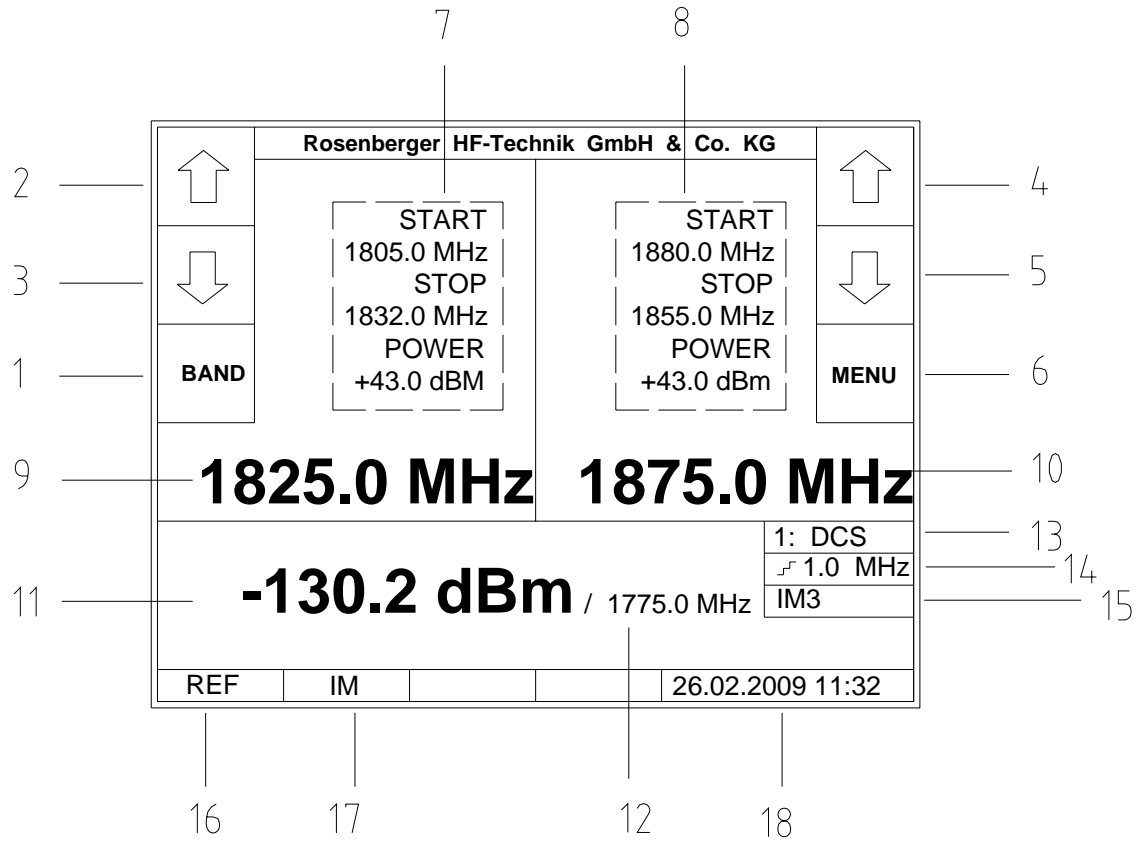

Fig 2-1 Display screen

1	<b>BAND soft key</b>	switches to a different frequency band <sup>1</sup>
2	<b>Left arrow up soft key</b>	increases $f_1$ by 1MHz
3	<b>Left arrow down soft key</b>	decreases $f_1$ by 1MHz
4	<b>Right arrow up soft key</b>	increases $f_2$ by 1MHz
5	<b>Right arrow down soft key</b>	decreases $f_2$ by 1MHz
6	<b>MENU soft key</b>	enters setup menu

<sup>1</sup> Not applicable with portable and site analyzers.

7

<b>Output parameters for frequency <math>f_1</math></b>	START	start frequency for sweep
	STOP	stop frequency for sweep
	POWER	output power

8

<b>Output parameters for frequency <math>f_2</math></b>	START	start frequency for sweep
	STOP	stop frequency for sweep
	POWER	output power

9

**Output frequency  $f_1$  for 2tone measurement**

10

**Output frequency  $f_2$  for 2tone measurement**

11

**Power level of PIM-product**

12

**Frequency of PIM-product**

13

<b>Current operating band</b>	AMPS/EGSM/DCS/PCS/UMTS/TD-SCDMA
-------------------------------	---------------------------------

14

<b>Frequency step for sweep measurement</b>	0.1~9.9MHz
---	------------

15

<b>Order of PIM-product</b>	IM3/IM5/IM7
-----------------------------	-------------

16

<b>Measurement mode</b>	REF (Reflected): reversed mode TR (Transmitted):transmitted mode <sup>2</sup>
-------------------------	--

17

<b>Measurement mode</b>	IM (intermodulation measurement mode) VSWR (VSWR measurement mode) <sup>3</sup>
-------------------------	--

18

**System time and date**

<sup>2</sup> Not applicable with portable and site type analyzers.

<sup>3</sup> For future applications.



## Accessories

The accessory kit includes several kinds of test cables, connectors, standard adapters, Terminators, etc from which customers can choose depending on their requirements.

### Standard adapters

Standard adapters have constant IM value. They are used to detect whether the system is accurate or not.

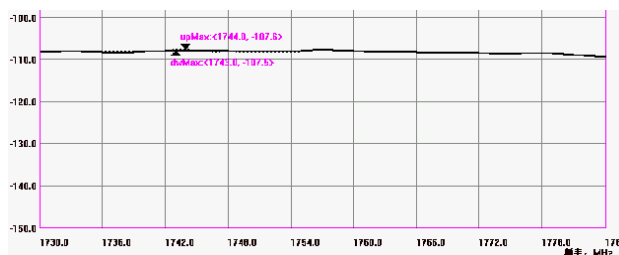
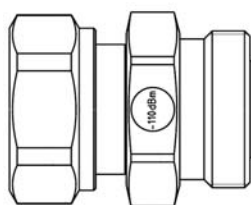

Fig 1-4 -110dBm Standard adapter

### Portable low PIM termination

The low PIM terminator absorbs the high power level which passes through the DUT and suppresses interference caused by reflected power. Never switch the Analyzer to TX-mode without a DUT or terminator connected. The intermodulation, caused by the low PIM termination should be less, then the noise level of the Analyzer.

A proper low PIM termination is essential for accurate measurements.

Refer to **Chapter 3 Application** for details.



Fig 1-5 Portable low PIM termination

## Chapter 2 Operating the PIM-Analyzer

### Preparation for Use

#### Intended Use / Operating environment

This PIA is specially designed for tor measurement of reversed 3<sup>rd</sup>, 5<sup>th</sup> and 7<sup>th</sup> order intermodulation products. The analyzer set up complies with the test methods suggested by proposal paper IEC 62037. Operate the Analyzer on an even and stable surface.

Environmental conditions should be dry and clean. Avoid sunshine to the analyzer, indoor use only.

#### Connect test cables

Before connecting test equipment clean the connectors with alcohol i.e. isopropyl. To dry the connectors and to remove metal abrasion, it is recommended to use cleaned and filtered compressed air.

Tighten connectors with a proper torque wrench.

For the first steps with the PIM analyzer it is recommended, that you connect the -110dBm standard adapter and the low PIM termination.

#### Connect AC power

The PIM analyzer adapts itself to different AC voltages, specified in the datasheet.

Make sure, the power connectors are pushed all the way into the wall outlet and the AC power socket on the Instrument.

### Manual operation

#### Power on

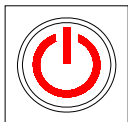

Push **POWER** button to switch power on. After initialisation and self check the analyzer shows the normal operation screen.

## System setup

The **MENU** button activates the setup menu.

Select PIM product to be detected:

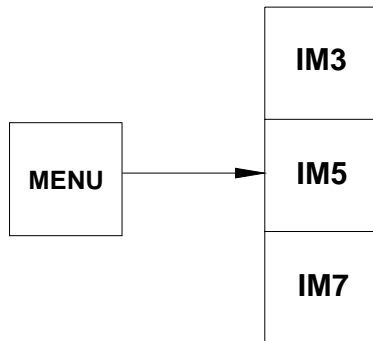

Select unit to be displayed (dBm or dBc):

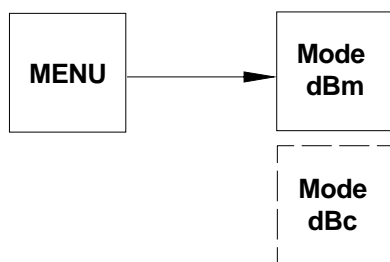

Set frequency step size for sweep measurement:

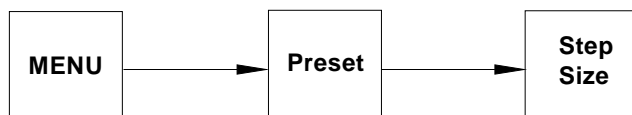

Enter a value in the format, displayed on the screen. Confirm with unit button.



Step Size can be set from 0.1MHz to 9.9MHz

**Set time:**

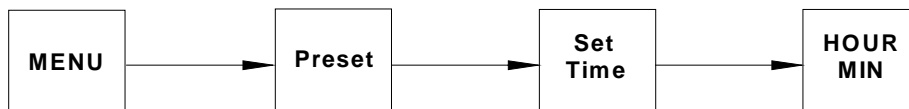

Enter a value in the format, displayed on the screen. Confirm with unit button.

Enter:  
Hour (0-23) / Min [ HH . MM ] :

**Set date:**

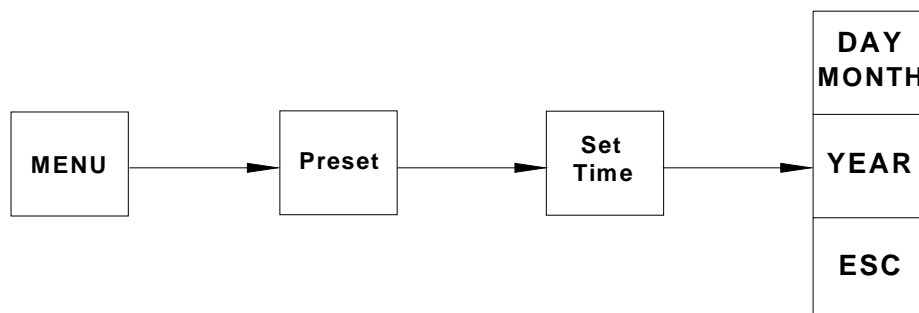

Enter a value in the format, displayed on the screen. Confirm with unit button.

Enter:  
Day / Month [ DD . MM ] :

Enter:  
Year [ 20YY ] :

**Select communication interface:**

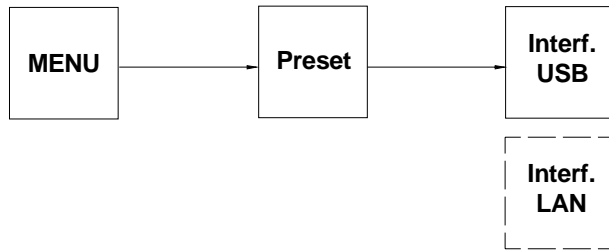

**Select internal detector or external spectrum analyzer:<sup>4</sup>**

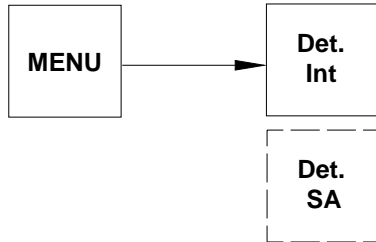

**Set limit line:**

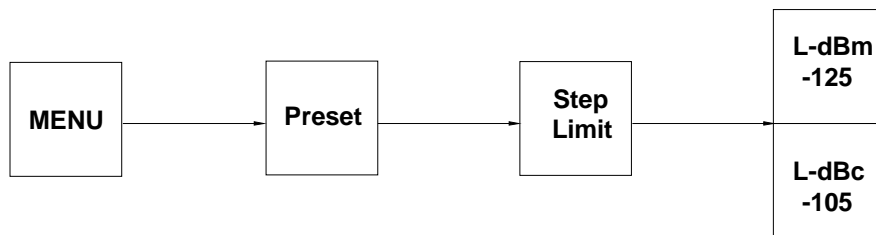

Set limit line in dBm

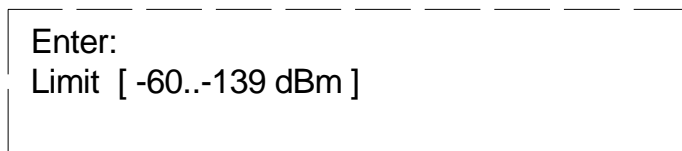

Set limit line in dBc

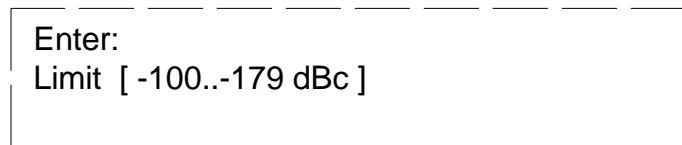

The limit line is displayed as a thick horizontal line on the graph screen. If a measurement exceeds the limit, the fail flag will show up and an alarm will sound.

<sup>4</sup> In portable and site analyzers the internal detector should be chosen.

## Operation mode setup

### Frequency setup

➤ **2-tone measurement mode**

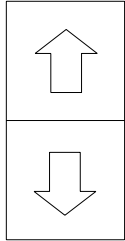

Press to increase or decrease the frequencies  $f_1$  and  $f_2$

The second way to set the frequencies for 2-tone measurement is via the key pad. Press **FREQ** on the right or left side, then input data with number keys and press unit key to confirm.

If you want to set 1825MHz, enter keys in following order:

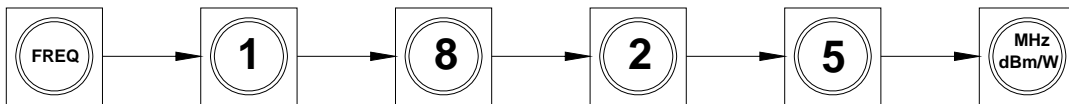

While typing, the entered value and allowed frequency range will be displayed on the screen.

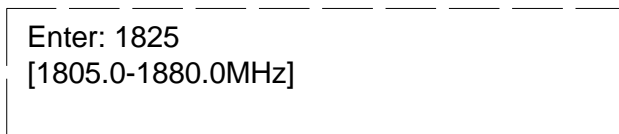

If you want to modify the second output frequency, press FREQ on the other side of the screen and repeat the steps above.

If the entered frequency is out of range, an error message is displayed:

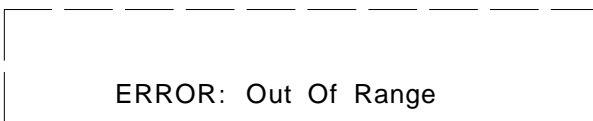

The frequency bands of the internal filters, diplexers and combiners limit the actual range of frequencies  $f_1$  and  $f_2$  which make sense to measure with. The frequencies  $f_1$  and  $f_2$  have to be within the TX range and the measured PIM frequency has to be within the RX range.

The frequency of the measured PIM frequency is calculated, depending on the order according to the following table:

Order	PIM frequency
3	$2 \cdot f_1 - f_2$
5	$3 \cdot f_1 - 2 \cdot f_2$
7	$4 \cdot f_1 - 3 \cdot f_2$

RX and TX ranges of the different frequency bands are listed in the following table.

Frequency Band	RX Range	TX Range
----------------	----------	----------

LTE 700	698 – 730 MHz	745 - 793 MHz
AMPS 800	824 – 849 MHz	869 – 894 MHz
EGSM 900	880 – 915 MHz	925 – 960 MHz
DCS 1800	1710 – 1785 MHz	1805 – 1880 MHz
PCS 1900	1850 – 1910 MHz	1930 – 1990 MHz
TD-SCDMA 2000	2015 MHz	2020 / 2025 MHz
UMTS 2100	1920 – 2060 MHz	2110 – 2170 MHz
UMTS II / LTE / BRS-EBS	2545 – 2580 MHz	2620 – 2695 MHz
WiMAX	3410 – 3484MHz	3510 – 3595 MHz

It is important, that  $f_1$  is always lower in frequency than  $f_2$ .

The lowest possible PIM-frequency calculates from the lowest  $f_1$  and the highest  $f_2$ .

### ➤ Sweep measurement mode

Start frequency and stop frequency can be set via Soft-key **START** and Soft-key **STOP**.

Frequency step can be set via Soft-key **Step Size**.



### Power setup

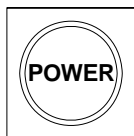

Press **POWER** key to set up the output power. The steps are the same as frequency setup.



If input data is out of range, the same Error as frequency setup will appear.

### Start measurement

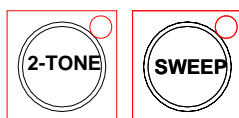

Make sure that all setups and connections are done.

Press **2-TONE** or **SWEEP** to start measurement.

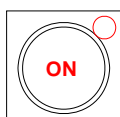

Status indicating lamps on both sides are on which means power are output.

Shortly press **2-TONE**, the test result will be displayed as graphic on the screen.

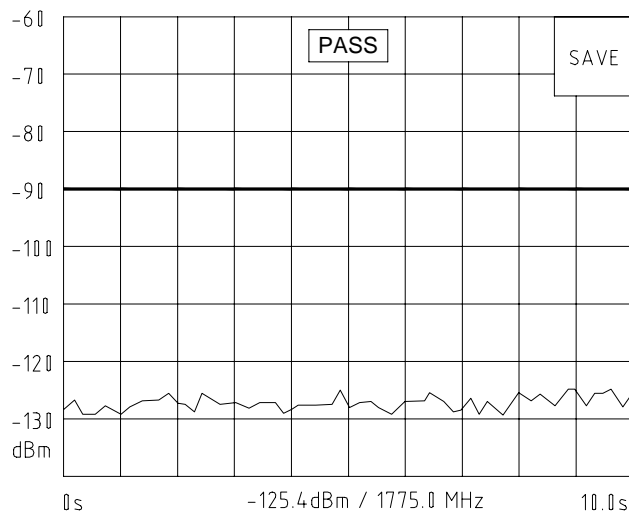

If all the measurement results are below the limit line, the system will declare **“PASS”** the measurement, otherwise **“FAIL”** the measurement.

Long press **2-TONE**, the real time test result will be displayed on the screen.

**-130.2 dBm** / 1775.0 MHz

The result means detected PIM at 1775MHz is -130.2 dBm.

Shortly press **SWEEP**, start single up & down sweep measurement.



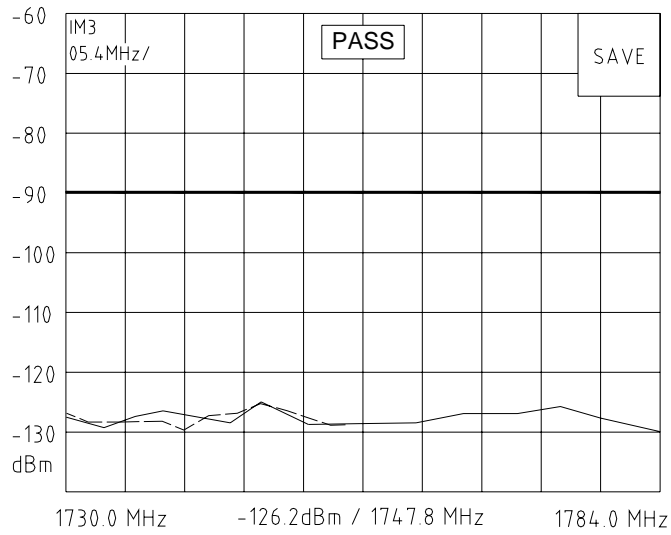

Long press **2-TONE**, start endless sweep measurement

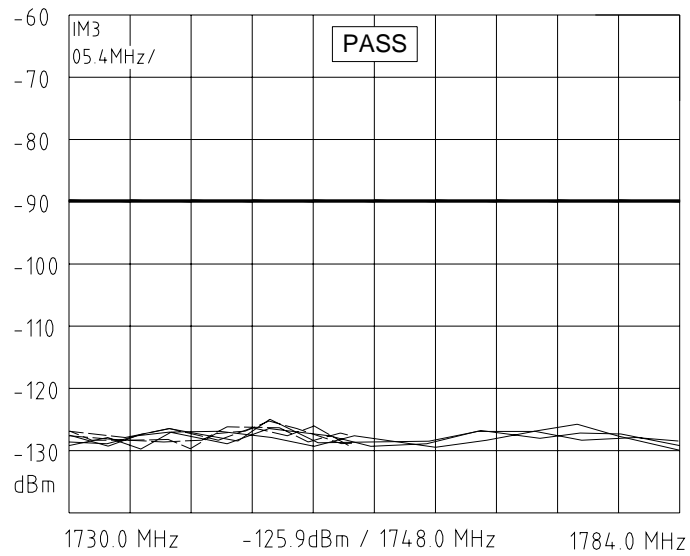

Plug memory stick into USB port (port 10 on the front panel), then press **SAVE** key:

Enter File Number ( 0 - 999 ) :

Type in the file number (3 bit), the measurement result will be saved in memory stick automatically.

*Notice: before modifying output power, make sure signal sources are off. After modification, switch on again.*



*Notice: After 1 minute of continuous operation let the instrument cool down for 5 minutes*

## Software

### Run PIA

Install PIA software provided by Rosenberger.

Double click PIA icon to run software, and measurement interface shows as Fig 2.2:

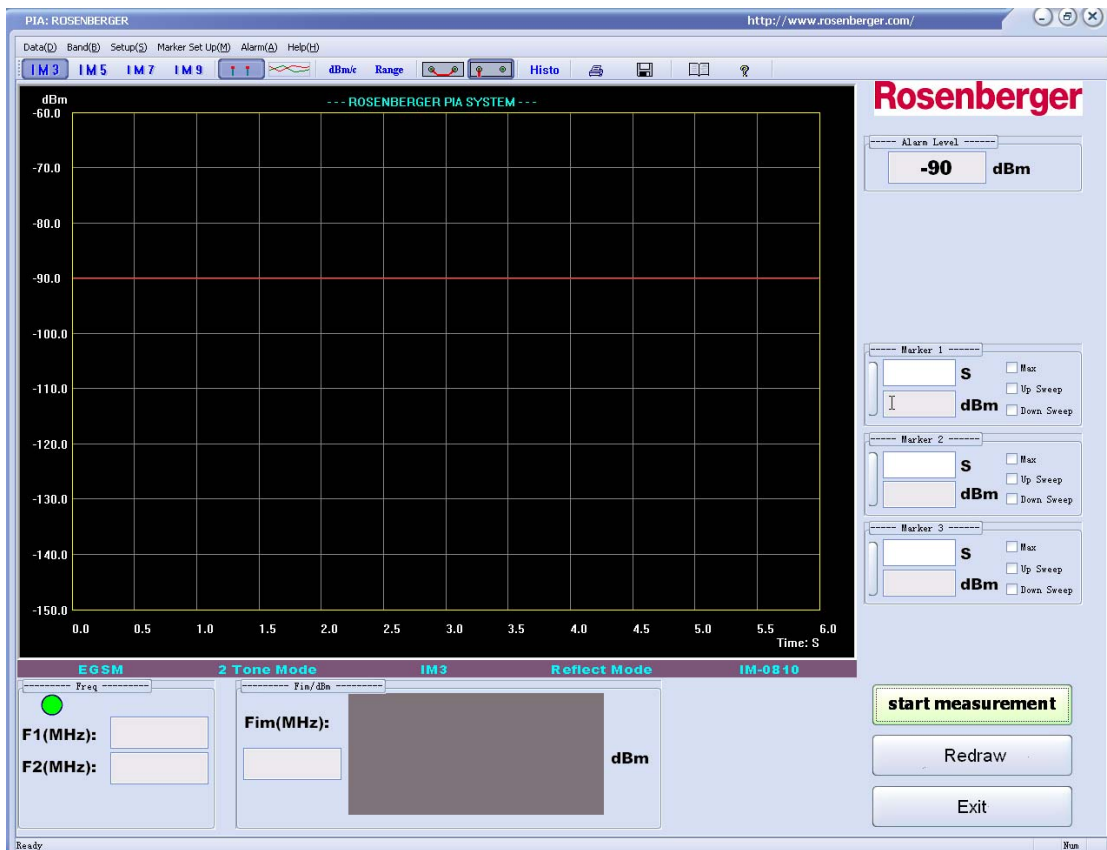

Fig 2.2 measurement interface

The default setup: current band of PIA、 2 Tone measurement mode、 IM3、 Reversed mode.

See the status bar:



If there is no need to change these default setups , make sure the frequency band has been set and then you can start measurement directly. If you need to change some setups, please follow steps below:

## System setup

### Port setup

If only one module is connected with PC, the port can be identified automatically. Otherwise, please choose correct port manually:

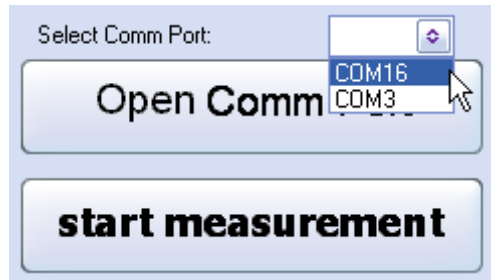

Click ” Open Com Port” to connect PIA. If it is connected successfully, the indicating lamp will turn green

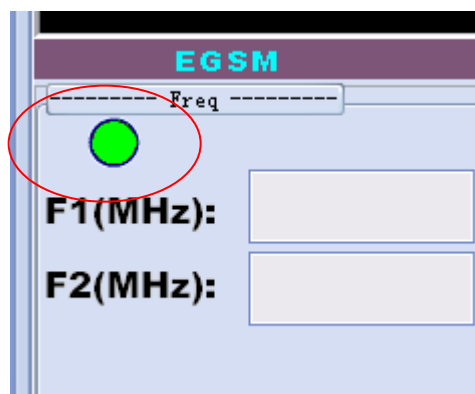

the information on status bar will show the equipment is identified

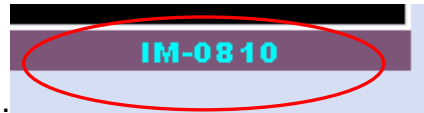

## Frequency band setup

Click "setup->Band->EGSM 900",

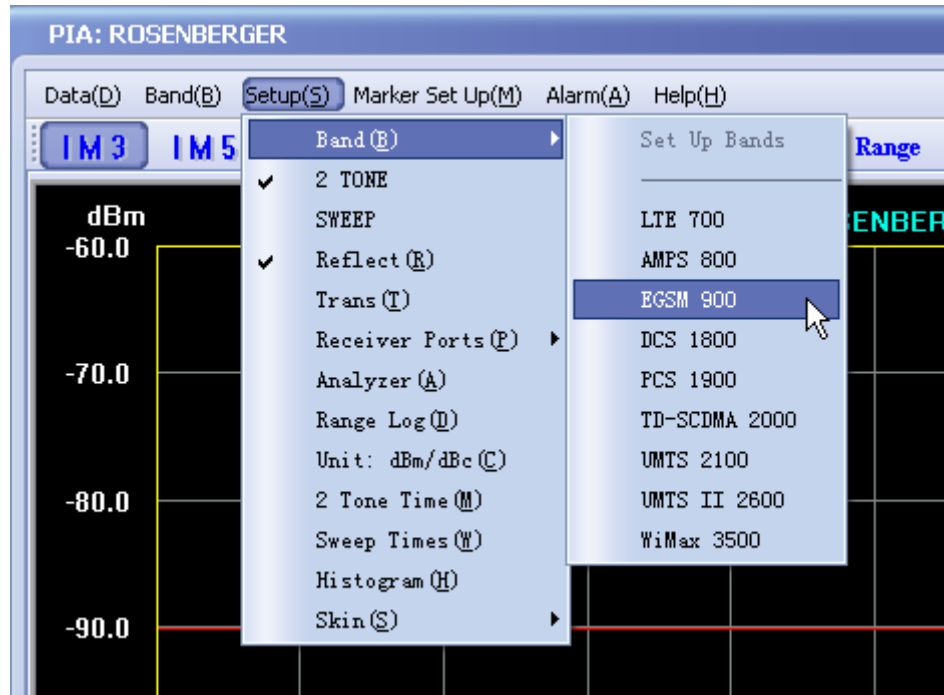

Window pops up as follows:

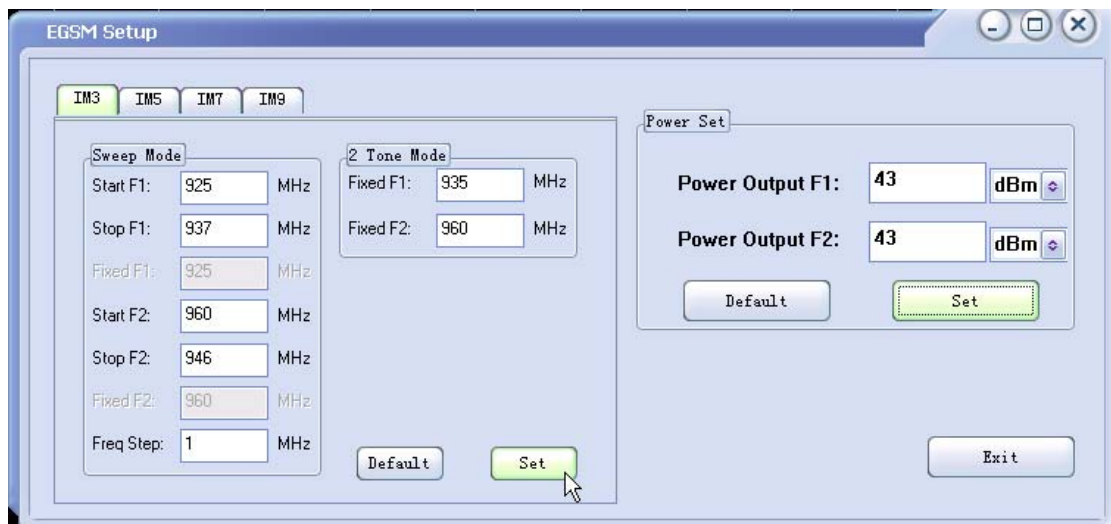

Fig 2-3 Frequency band setup

- Select IM3, IM5 or IM7 in left column, and set frequency parameters of carriers.
- 2 Tone measurement mode: input frequency of two carriers, then click "set" to confirm.

- Sweep measurement mode: input start and stop frequency of two carriers, then click “set” to confirm.
- Power setup: input power of two carriers, then click “set” to confirm.
- Click “default” to load back the default parameter setup.
- After all setups, click “exit”.

*Notice: The first time to start measurement at each frequency band, the setup above is request.*

## 2 Tone/Sweep measurement mode selection

- Click menu ”Setup”, select “2 Tone”

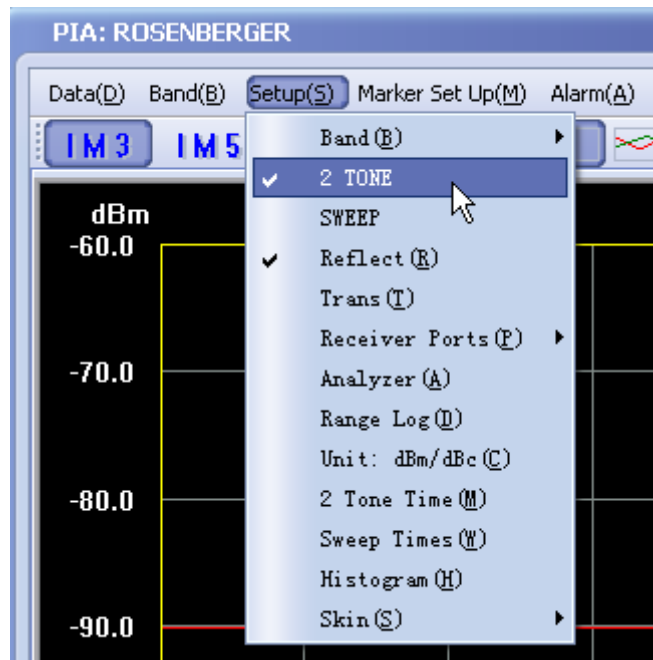

- 
- Click menu "Setup", select "Sweep":

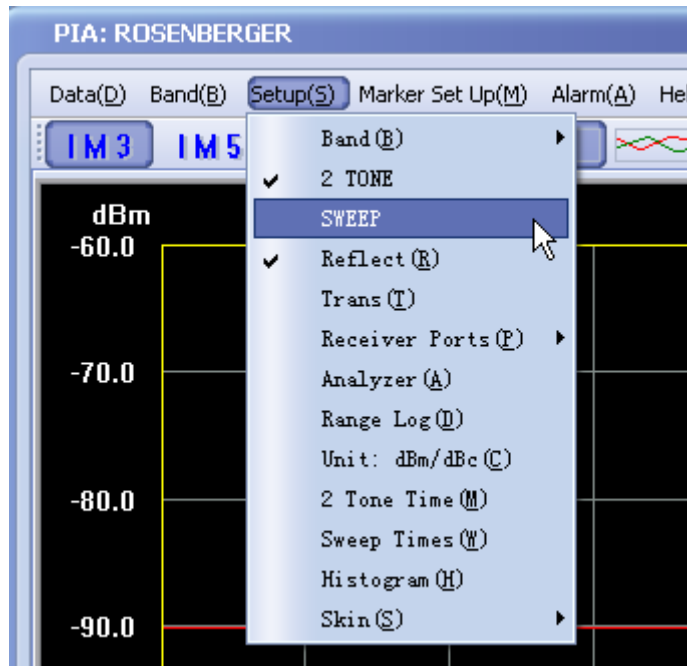

### Reflected/ Transmitted measurement mode selection

- Click menu "Setup", select "Reflect"(Transmitted mode is only for rack type):

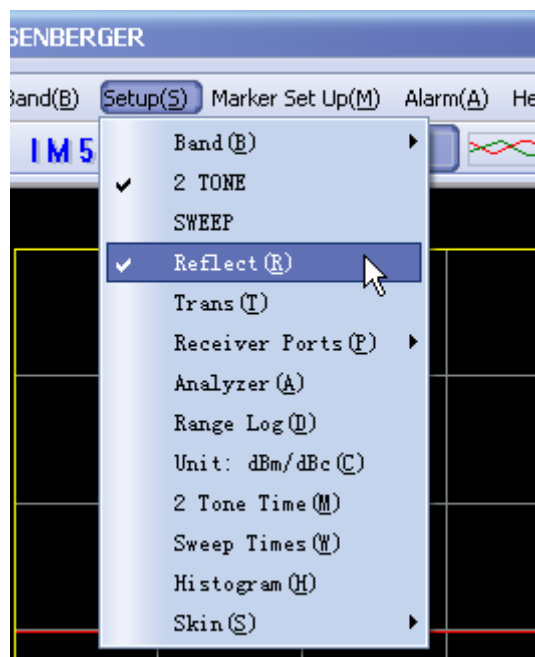

## Alarm setup

Click menu “Alarm->Modify”:

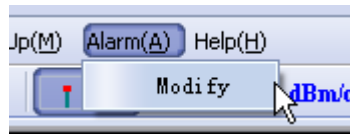
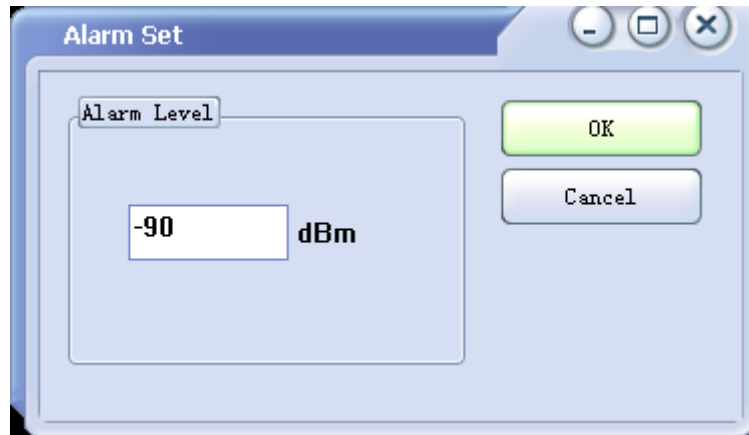

Fig 2.12 modify alarm



Input the alarm level, click “OK” to finish and exit.

The alarm level will be illustrated on the measurement interface:





## Start measurement

### Intermodulation product setup

Please pay attention before starting measurement:

- The order of intermodulation product

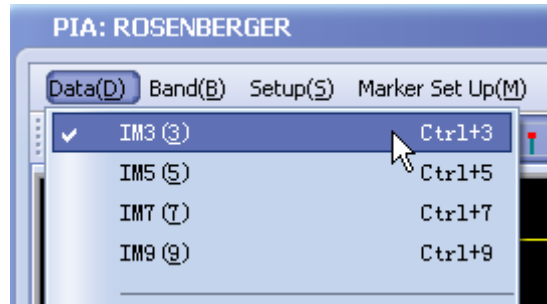

- Select operating band

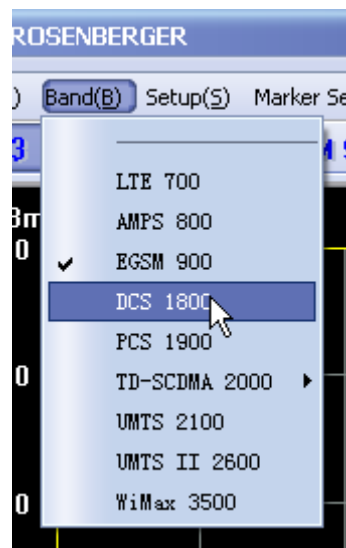

*Notice: If current status satisfy measurement requirement, there's no need to set again.*

### Start measurement

**start measurement**

Click to start measurement

### Measurement result

Observe the real-time measurement result:

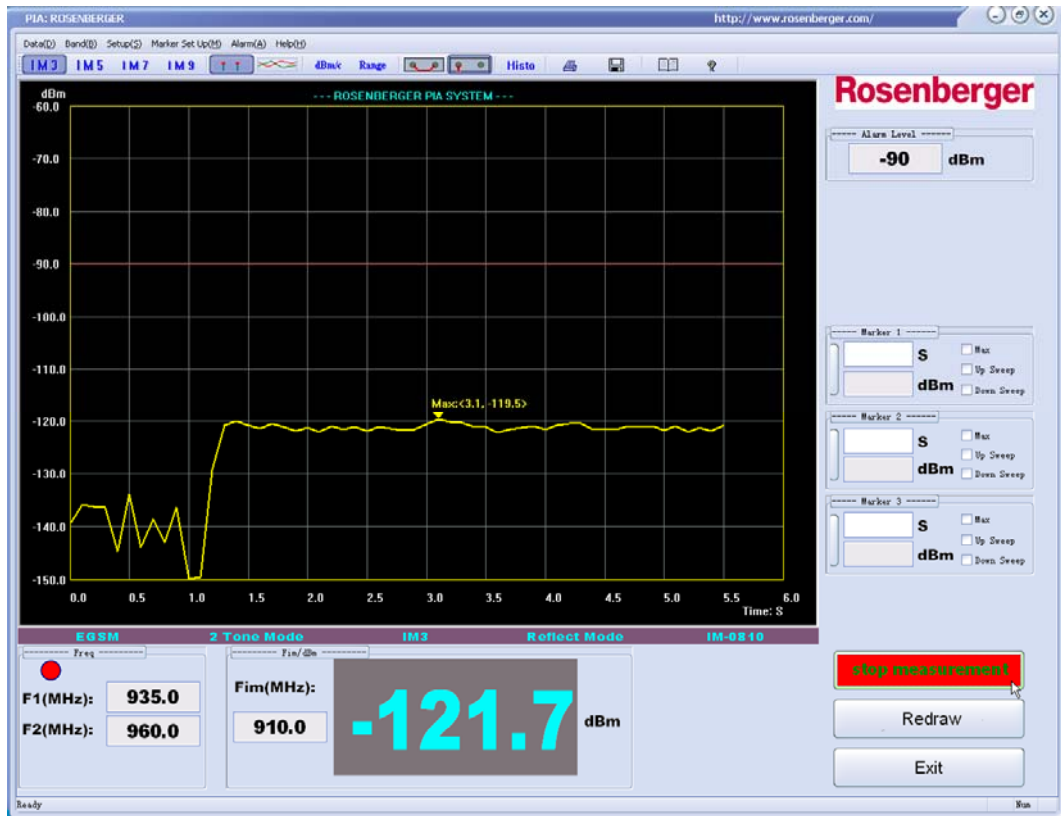

Fig 2-4 2 Tone measurement result

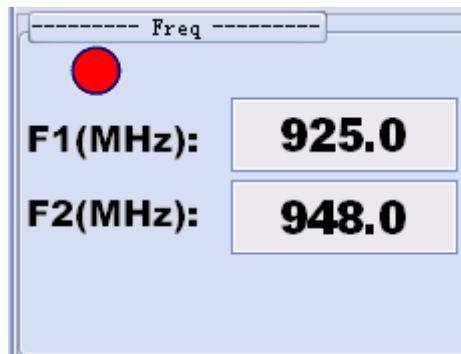

Fig 2-5 Sweep measurement result

During measurement, you can click  to stop at anytime.

## Analyzer results

- Real-time carrier frequency



- Display real-time intermodulation product during measurement and catch the worst result after measurement.

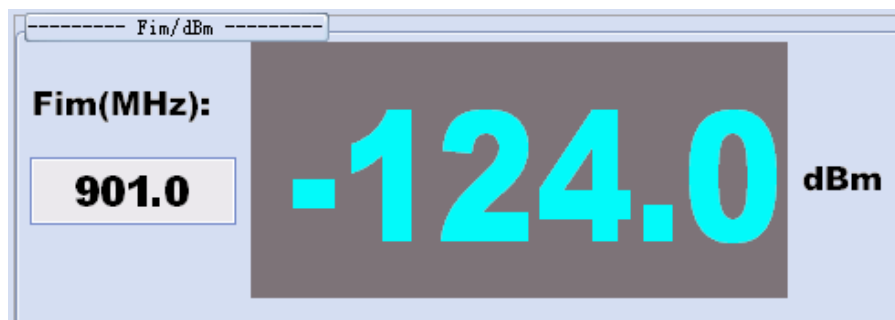

- If all results are below alarm line, pass the measurement.

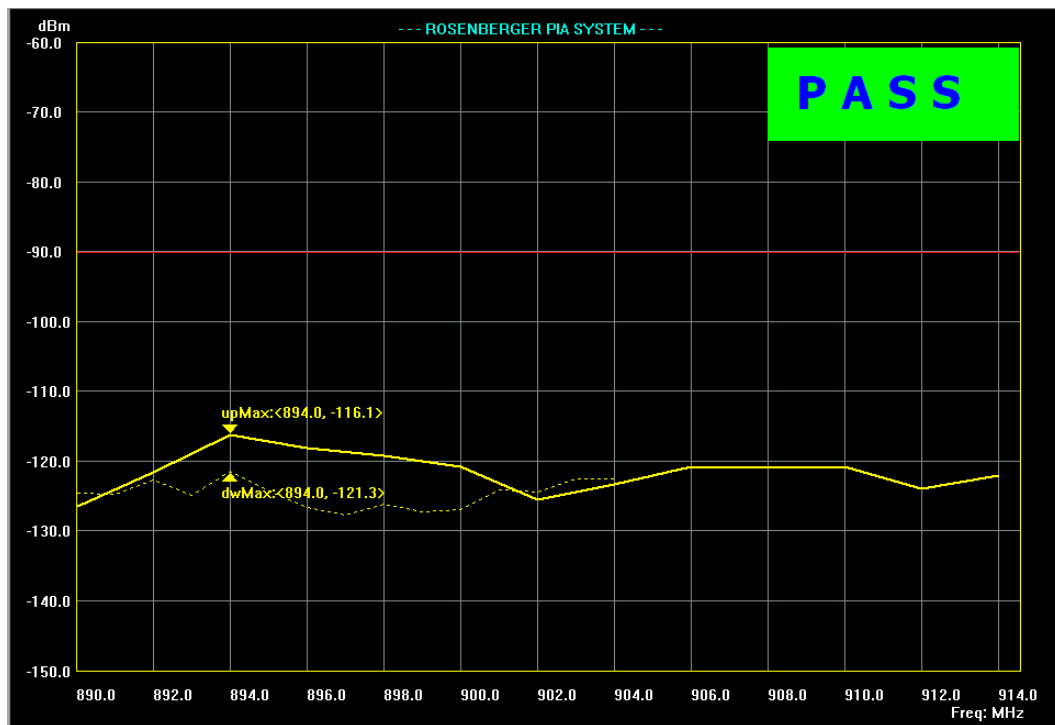

Fig 2-6 Pass the measurement

- If the results cross the alarm line, fail the measurement.

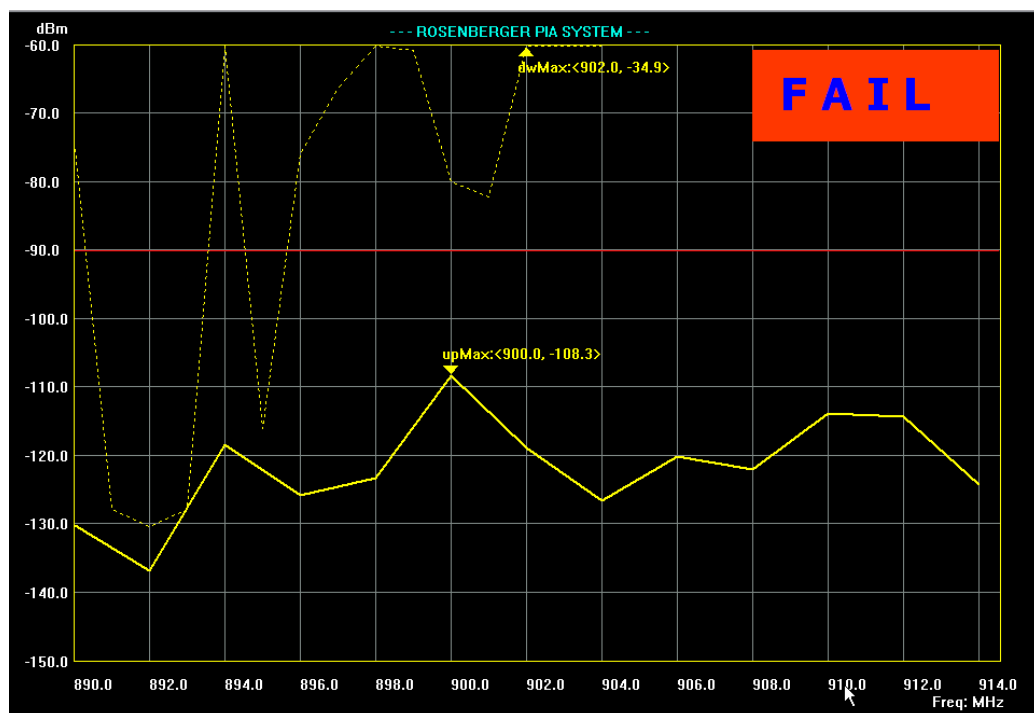

Fig 2-7 Fail the measurement

➤ Marker function

Customers can set markers to observe any point they are interested in under both 2 Tone and sweep measurement mode.

Click the indicating lamp on the left side to enable the marker ( Fig 2-8) .

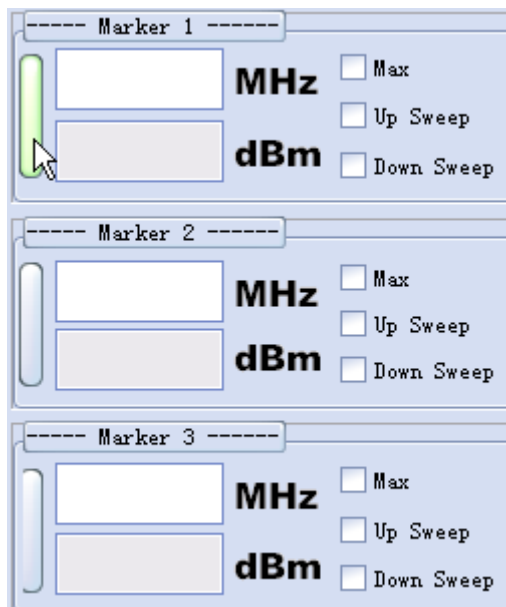
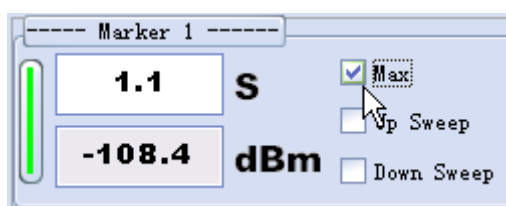
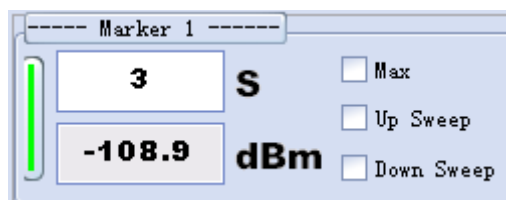

Fig 2-8 Marker function

After 2 Tone measurement, select” Max”, marker will search the worst point automatically (Fig2-9a). If don’t select “Max”, customer can input the time point they are interested in to observe the result (Fig2-9b).



a. the worst point



b. measurement result at any time

Fig 2-9 Marker function under 2 Tone measurement

After sweep measurement, marker can be used to catch the worst point of up sweep, down sweep and the whole measurement result (Fig 2-10) .

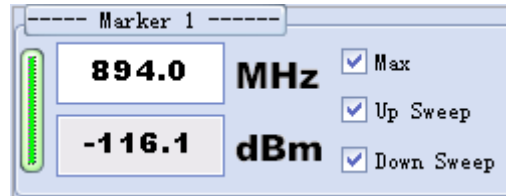

a. The worst point of the whole measurement result

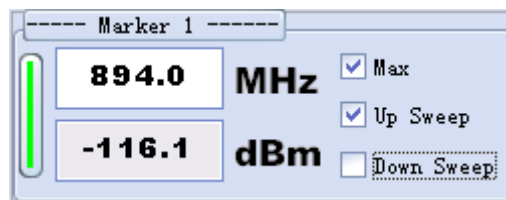

b. The worst point of the up sweep measurement

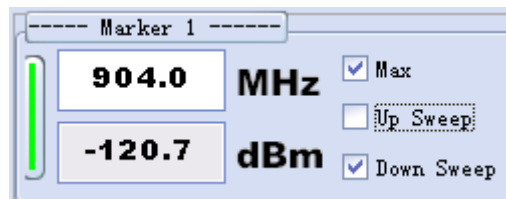

c. The worst point of the down sweep measurement

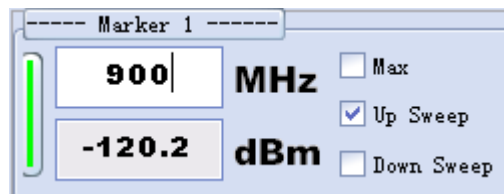

d. Any point of up sweep measurement

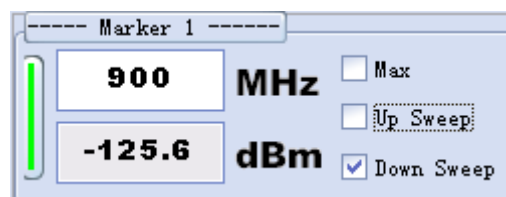

e. Any point of down sweep measurement

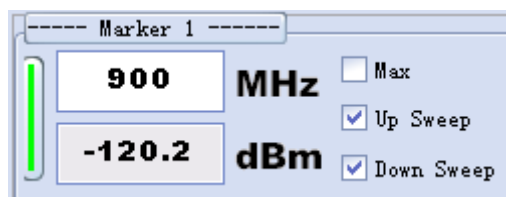

f. The worse result between up and down sweep measurement at the same frequency,

Fig 2-10 marker function under sweep measurement

If there are several groups of sweep measurements, you also should choose with group to be observed:

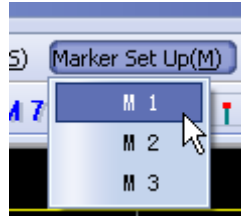

Marker2 and Marker3 are of the same setups as Marker1.

## Store result and create report

### Store and print

Click “Data-> Save BMP” to store result as a picture:

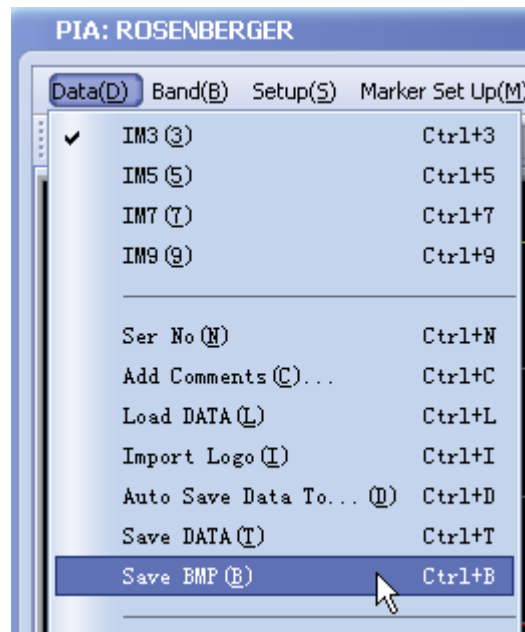

Click “Data-> Save DATA” to store result as a text file:

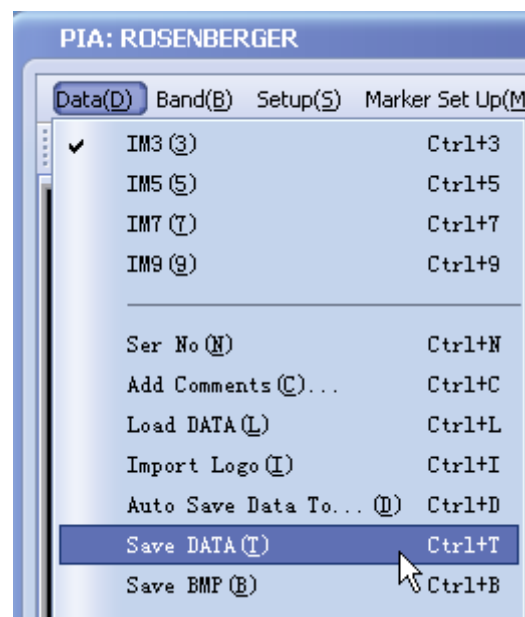



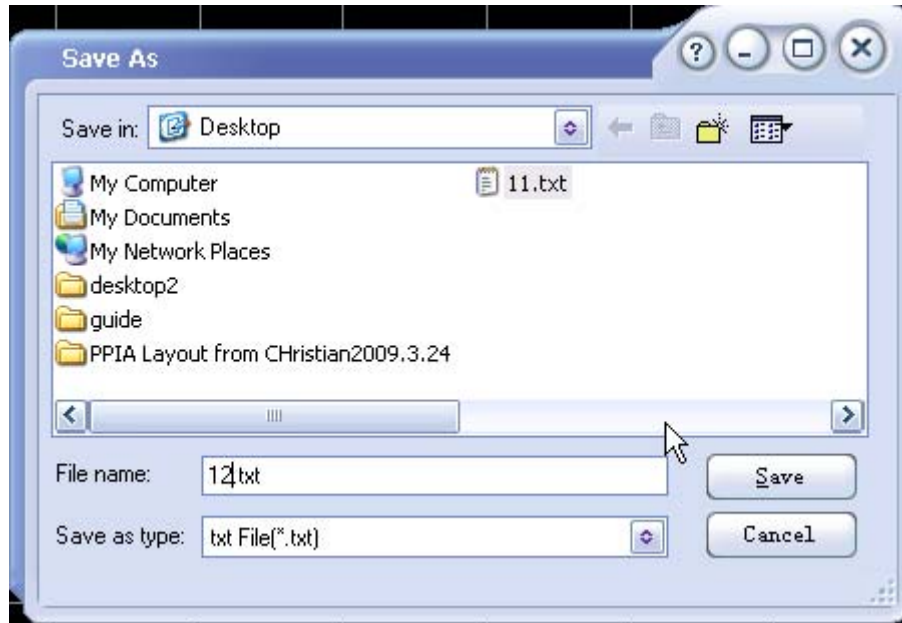

Click “Data-> Print” to print out report:

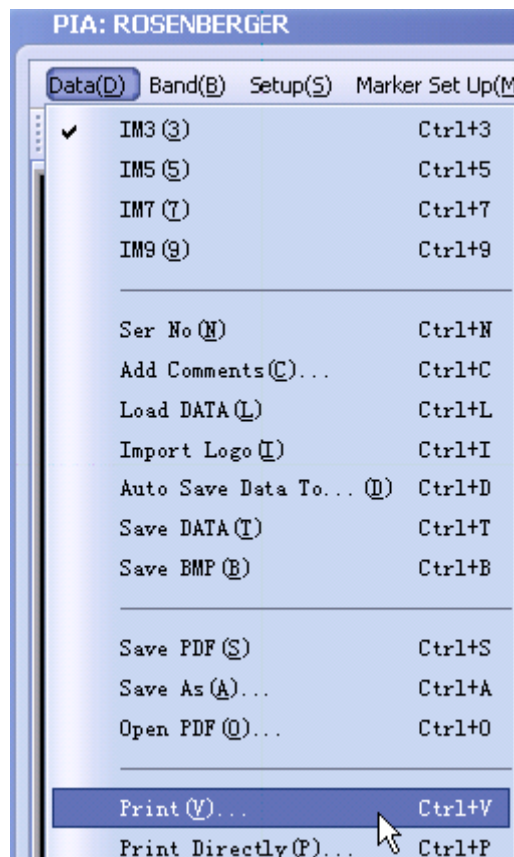

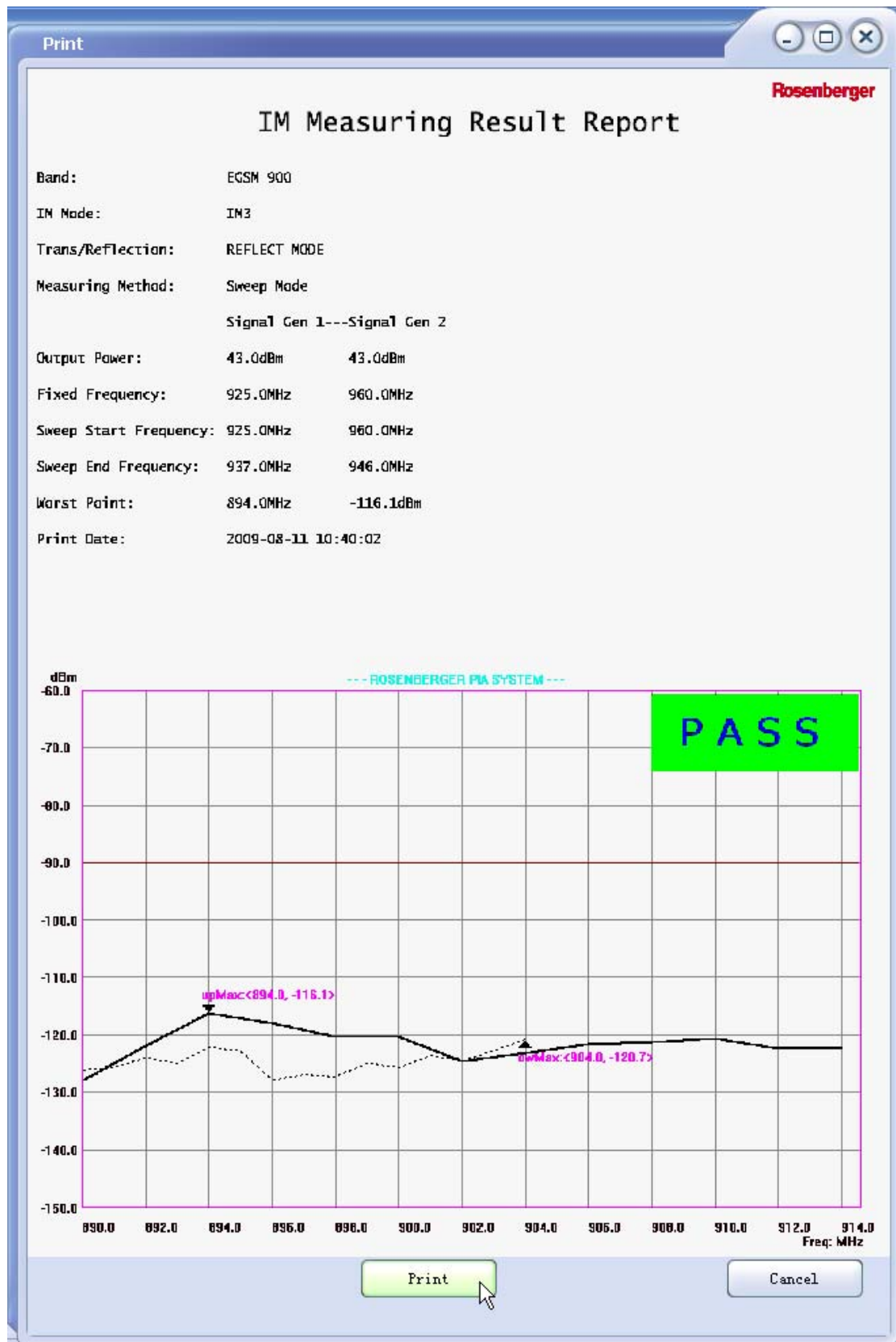
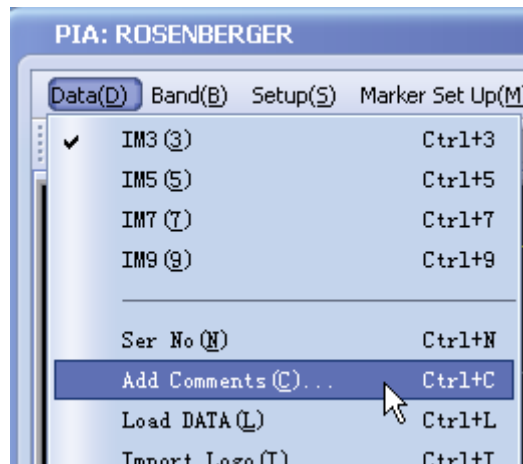

Fig 2-11 Report interface

Click button "Print" to print out the report.

## Add comments in report

Click “Data-> Add Comments”:



Type comments in and click "Add" button to confirm. Click "Close" to exit.

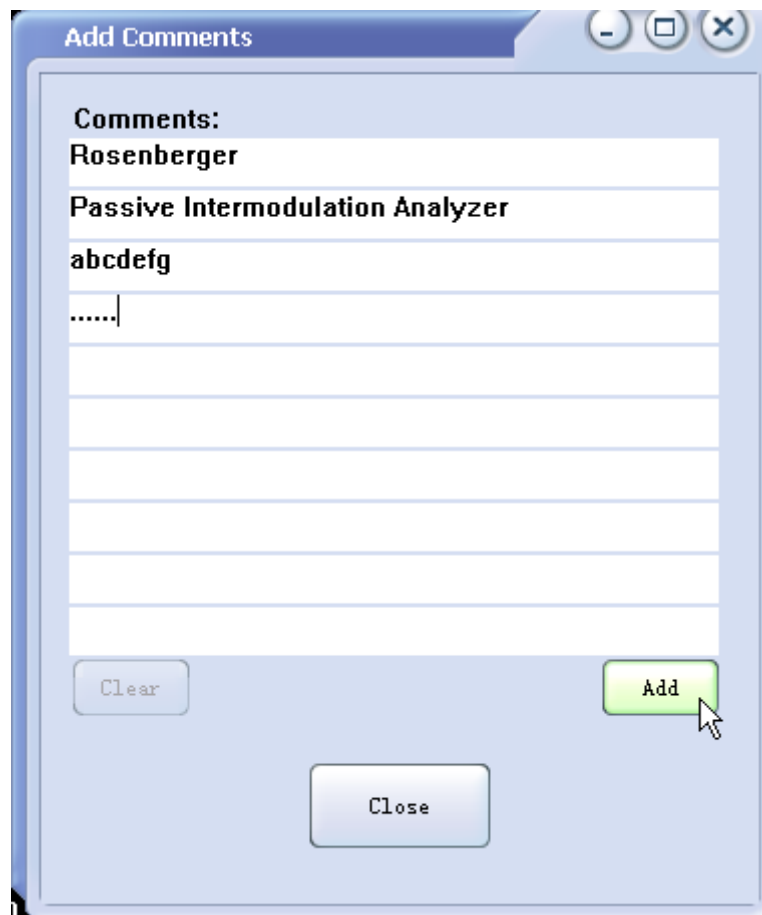

Comments have been added in report:

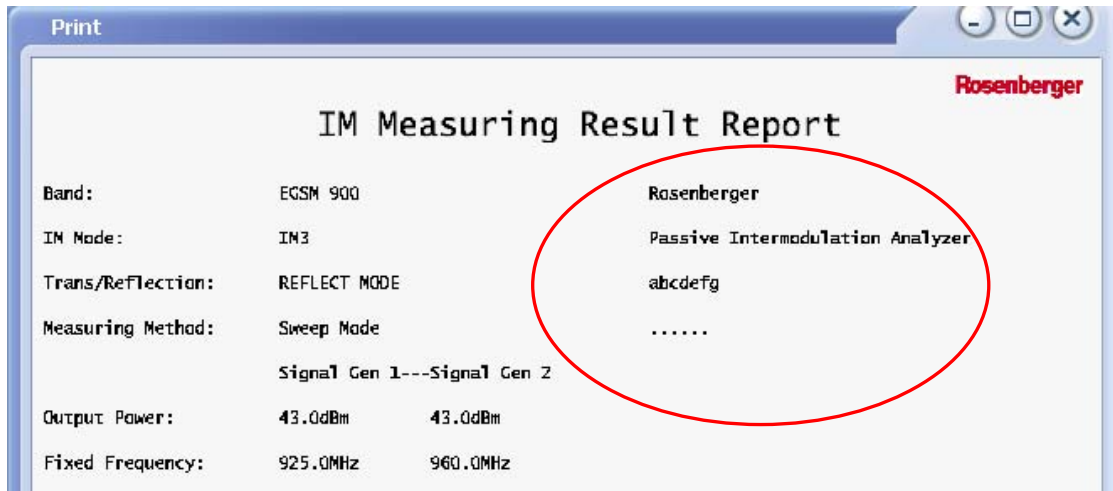

Fig 2-12 comments in report

### Modify Logo

Click “Data->Import Logo”

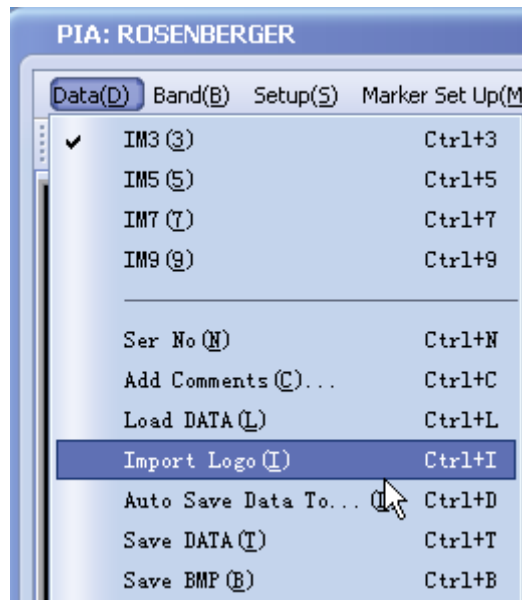
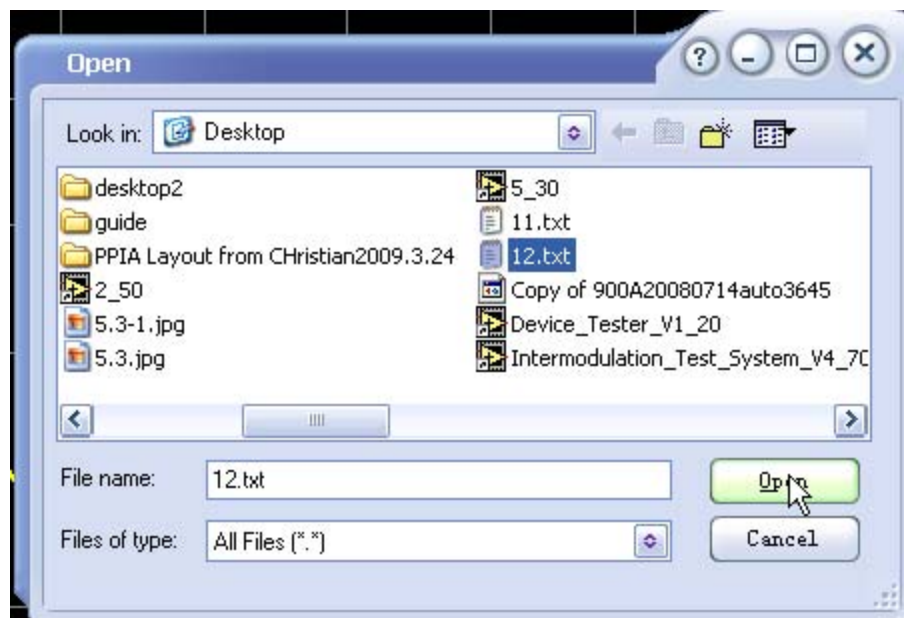
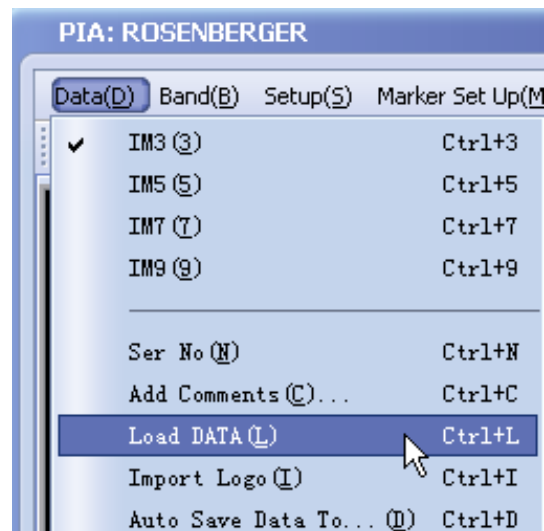

Fig 2.35 select “import logo” function

Find the existing logo file (bmp, size:136\*25) and import it.

## Load data

Click “Data-> Load DATA”, select the existing txt file, and open it.



## Exit

Click button "Exit" or icon "X" to exit when measurement is done.

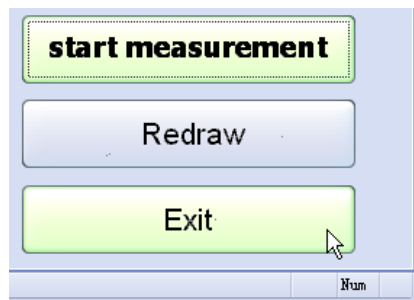

## Other functions

There are also some functions to make measurement easier:

### Histogram

Click "Setup->Histogram"

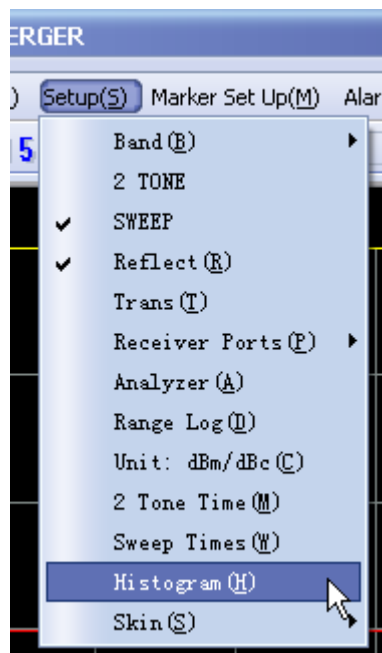

A histogram is located on the left side of display area. The altitude of the histogram indicates the current measurement result. If the result is above the alarm line, the histogram will turn red.

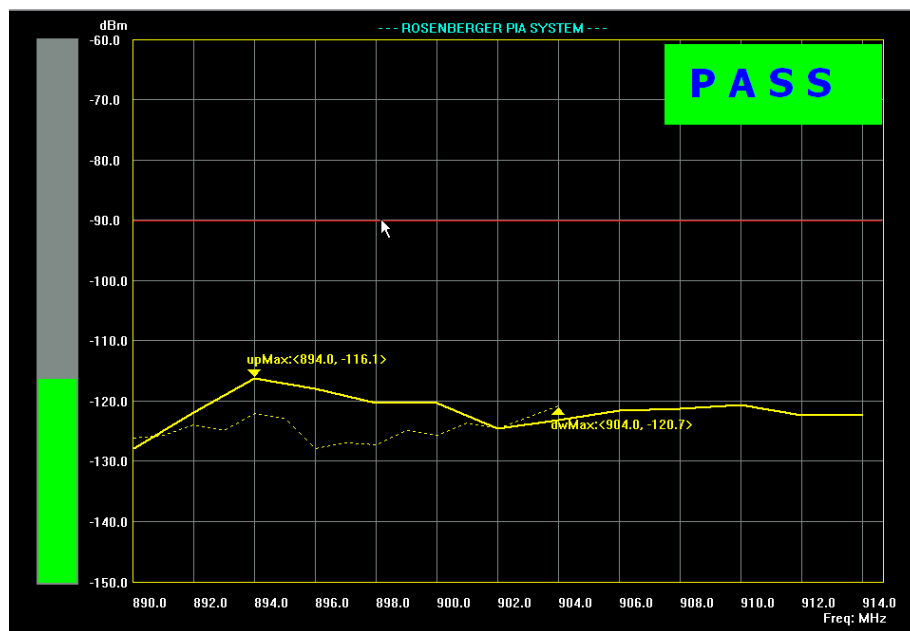
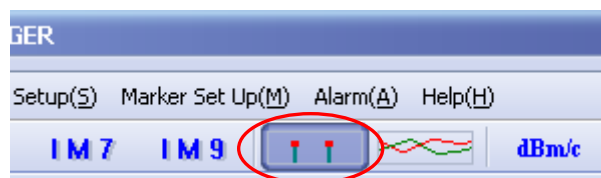

Fig 2-16 Histogram interface

Histogram makes it easier to observe the fluctuation of the measurement result.

**Shortcut icon**

- 2 Tone measurement mode



- Sweep measurement mode

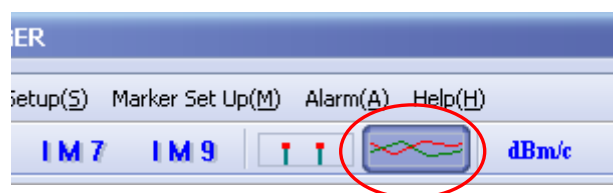

- Reflected measurement mode

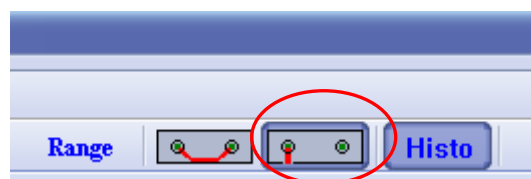

- Transmitted measurement mode

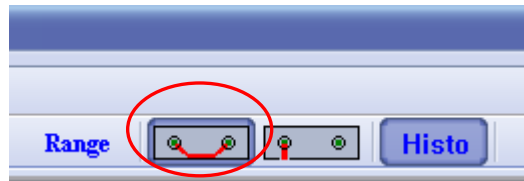

- Select the order of intermodulation product

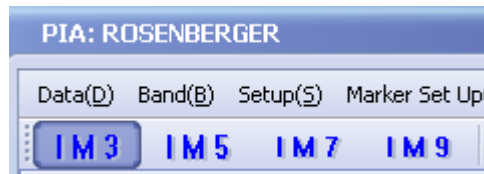

- dBm/dBc Unit switch

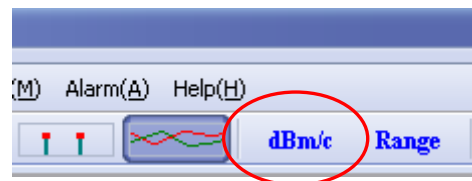

- Histogram

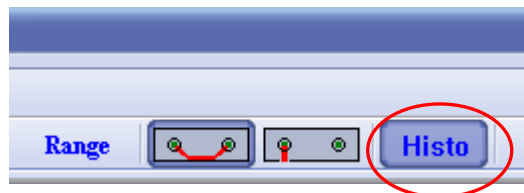



## Chapter 3 Application

The measurement of PIM is affected by many causes. In order to reach high accurate and stable measurement result, every operator is suggested to read this chapter carefully before starting measurements.

### Measurement range

Maximum measurement range is determined by Residual IM and Noise. Large range can guarantee accurate measurement result and reduce the influence of uncertainty. In the following, we will introduce the influence of residual IM and noise.

Residual IM comes from components of PPIA, including connectors, cables, filters, etc. General speaking, residual IM is inherent and causes more influence than noise, so PPIA measurement range is determined by residual IM most of the time. Most of the components in PPIA have been specially optimized by Rosenberger and have outstanding performances accordingly.

### Measurement Uncertainty

Test result should indicate the real intermodulation characteristics of DUT. However, in reality, it is affected by many causes, one of which is uncertainty.

The measurement uncertainty (RSS) can be calculated by the following formula:

$$RSS = \sqrt{(\delta A)^2 + (\delta P_m)^2 + (\delta P_g)^2 + (\delta D)^2 + (\delta Pr)^2}$$

Variable	Definition	Description
$\delta A$	Uncertainty of attenuator	When adopting power meter and attenuator to do calibration, the uncertainty of attenuator should be concerned.
$\delta P_m$	Uncertainty of power meter	The power meter is used to do the calibration of output power.
$\delta P_g$	Uncertainty of calibration generator	The generator is used as the signal source during calibration.
$\delta D$	Uncertainty due to the difference between self-intermodulation of the test bench and intermodulation of the DUT (taken from fig 1)	The closer the measurement result gets to residual IM of PIA, the larger the uncertainty will be. Fig 3.2-1 is taken from IEC 62037
$\delta P_r$	Uncertainty of receiver	The uncertainty of receiver which is used to receive IM products.

*Notice: The uncertainty of receiver is not included in IEC 62037. However, precisely speaking, the uncertainty of receiver can't be ignored. Therefore, Rosenberger considers all things in its PIA uncertainty evaluation.*

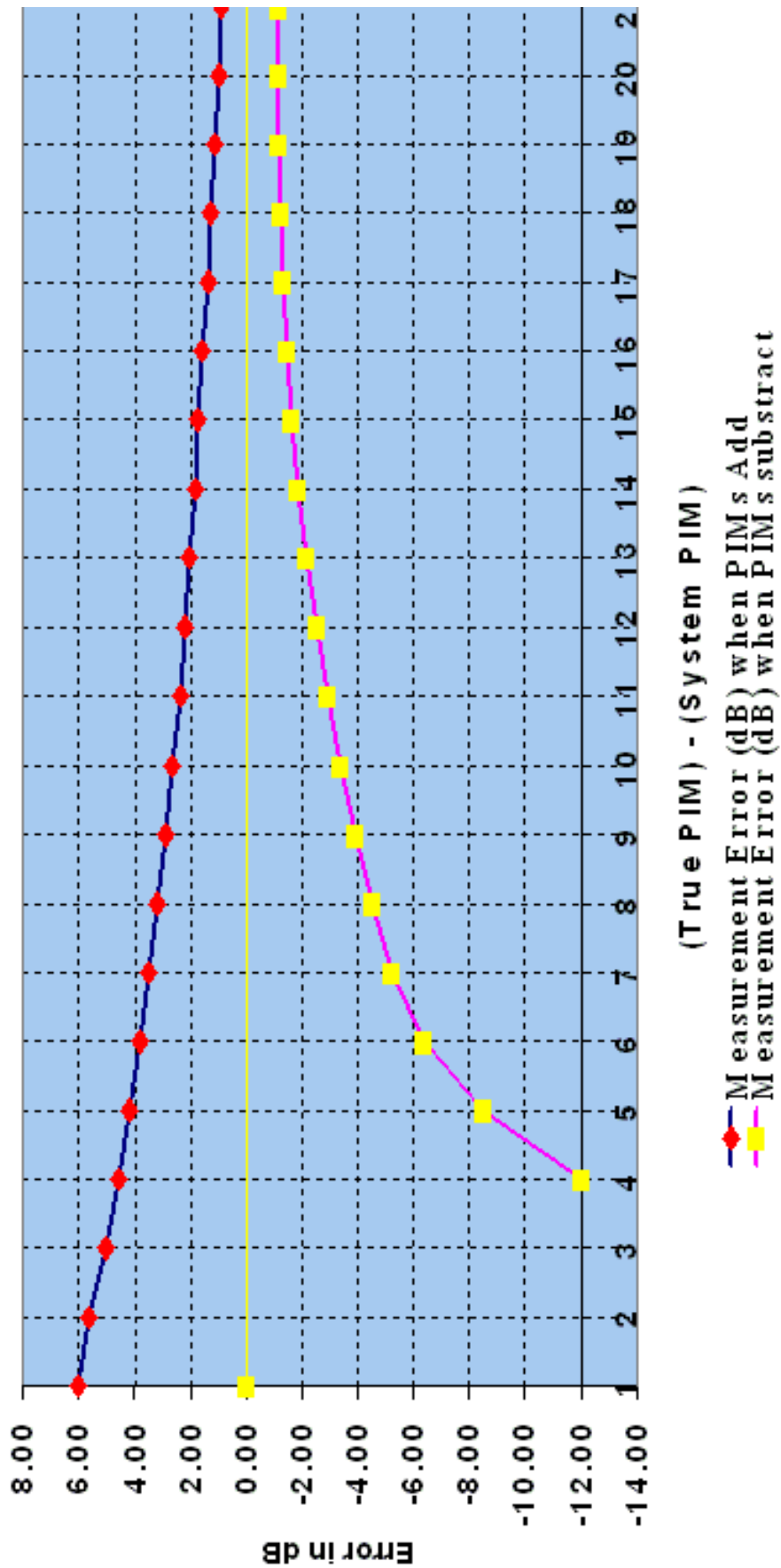

Fig 3-1 δ D

## **Test and maintenance**

PPIA is a kind of precise test instrument. Correct operation and maintenance will help costumers obtain accurate result. In the following, some operation and maintenance skills will be introduced.

### **Choose suitable test cables**

There are different configurations for measurement. To guarantee the accuracy of measurement result, Rosenberger recommends customers to take advice as follows:

#### **A choose low PIM test cable**

Rosenberger supplies many kinds of test cables for different measurement. Usually, corrugated cables suit long distance measurement of antennas. Semi-flexible cable is the most widely used cable with excellent return loss and attenuation and can be bended several times.

#### **B choose 360° contact connectors**

360° contact connectors has better performance. Among all types of connectors, 7/16 and N type have better PIM performance.

#### **C Avoid cable assembly with magnetic material**

If there are magnetic materials in signal paths such as stainless steel and nickel, PIM interference will be caused.

## **Protect test port**

#### **A choose suitable torque**

Connection is one of the most important facts causing PIM product. During measurement, intimate connection is necessary, so suitable torque wrench is recommended when connecting test report.

Rosenberger connectors' interfaces accord with international standard IEC 60169-4, VG 95250, EN 122 190, DIN 47223 completely and the quality accords with IEC 60068. The recommended torque is 25-30 Nm.



Use proper wrench  
in proper torque

Fig 3-2 use proper torque wrench

**B Use adaptor supplied by Rosenberger**

All PPIA are equipped with 7/16 female square flange connectors as test ports. Correct use and good maintenance will guarantee the accuracy and reliability of measurement results. Therefore, Rosenberger recommends that a 7/16 male-7/16 female (60S101-K50N1) adaptor be used at the test port. This adaptor with low PIM is optimized by Rosenberger. It is used to protect test port.

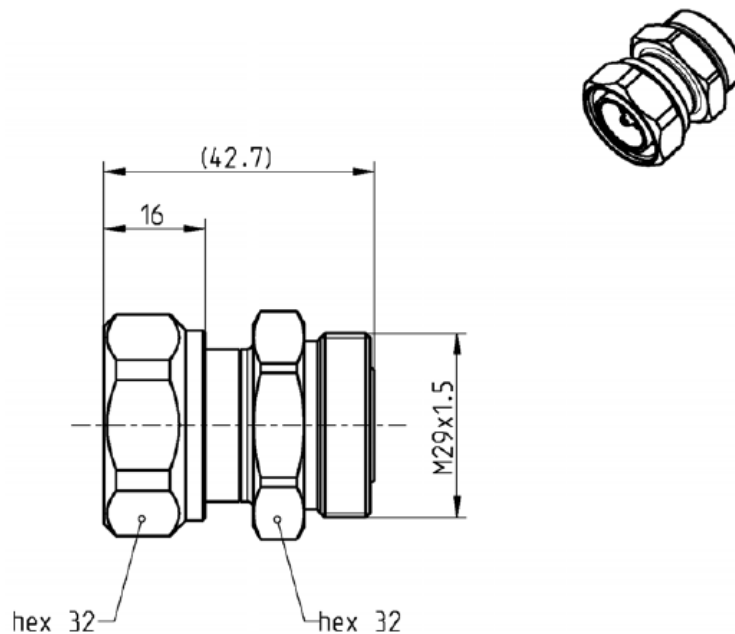

Fig 3-3 60S101-K50N1

### C Use protection caps

Most interfaces of test ports are plated with silver. Silver is a kind of material with low self-intermodulation but it is not stable and easy to be oxidized. Oxide in signal path is an important factor causing PIM product. It also degrades return loss and insertion loss performance. So, it is recommended that customers put protection caps on connectors while not using PIA.

*Notice: if test port on PPIA front panel is oxidized, the surface looks black. It needs to be dealt with special tools.*



Fig 3-4 without protection caps



Fig 3-5 with protection caps

## Measurement example

### Cable assembly measurement

Generally speaking, there are two kinds of solutions to measure cable assemblies: reversed measurement mode and transmitted measurement mode. Reversed mode is basic mode recommended by IEC62037 which suit to one port and multiple ports DUT. Reversed measurement module is the only configuration of Rosenberger Portable PIA.

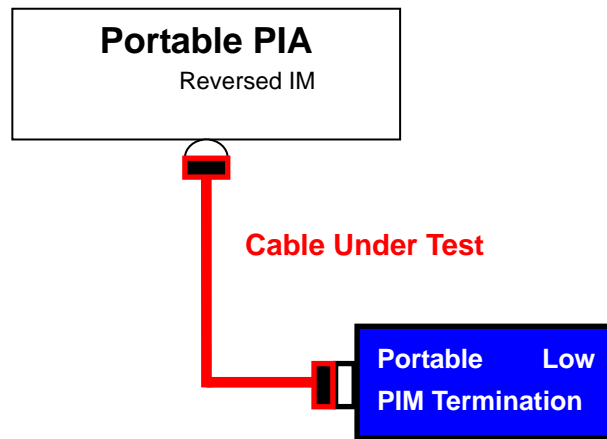

Fig 3-6 Reversed measurement mode

Fig 3-6 is block diagram of reflected measurement mode. The cable under test is connected between reflected measurement module and low PIM termination. After connection, start 2-tone or sweep measurement.

The low PIM termination should have good return loss in broad band, and can afford larger power—— $2 \times 40\text{W}$  from Rosenberger PIA test port. Please see the data sheet from Rosenberger.

## Antenna measurement

Antenna, which is located on top of base stations, is the last step of transmitting signals and the first step of receiving signals. The PIM index of antenna is very important for the whole communication system performance.

Antenna measurement is easy to be interfered, so low PIM test cable and good test condition (microwave chamber) is necessary. Block diagrams below indicate measurement solution of antenna.

Fig 3-7 is a block diagram of antenna measurement. A vertical polarized base station antenna is located in the chamber. Connect the input port to PIA and then start 2-tone or sweep measurement.

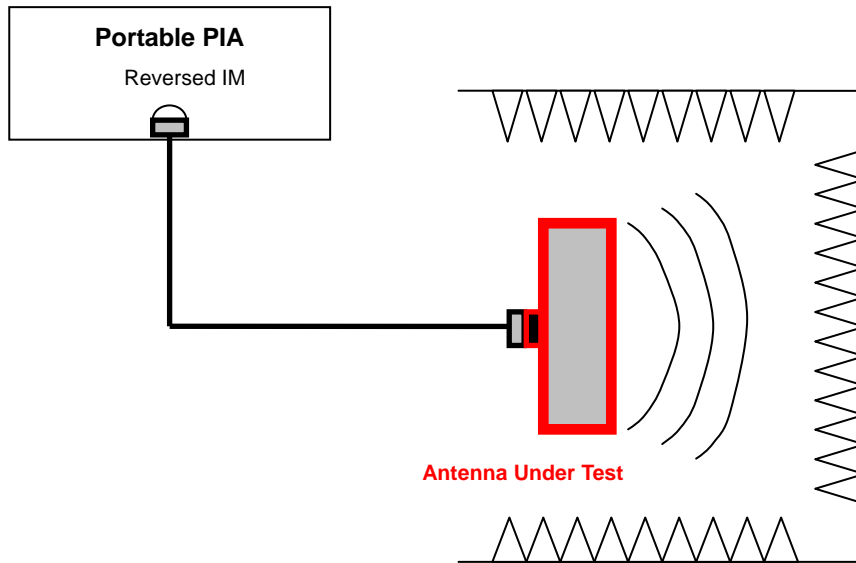

Fig 3-7 one-port antenna measurement

Fig 3-8 indicates another antenna measurement. This is a two-port dual-polarized base station antenna. Connect one port to PPIA, the other port to low PIM termination, then start 2-tone or sweep measurement.

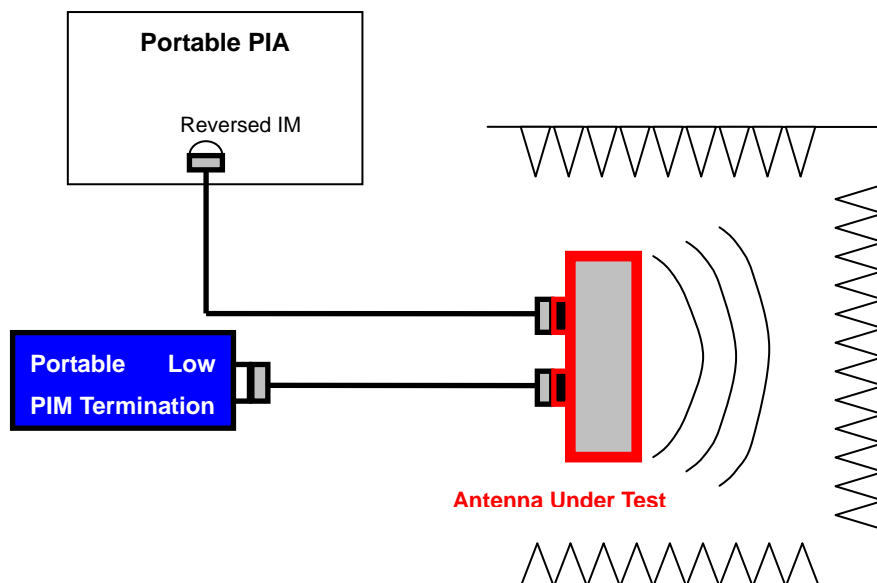

Fig 3-8 two-port antenna measurement

*Notice: Generally, test cables in antenna measurement are long. To guarantee the accuracy of measurement result, please check insertion loss of the cable before PIM measurement and compensate it via IM-SOFT.*



## Duplexer measurement

External receiver is request. Connect Tx port of the duplexer to the test port of PPIA. The antenna port of the duplexer is terminated in a low PIM termination. The Rx port of the duplexer is connected to the receiver.

If the isolation between Tx port and Rx port is high enough (>80dB), connection illustrated in Fig 3-9 is recommended.

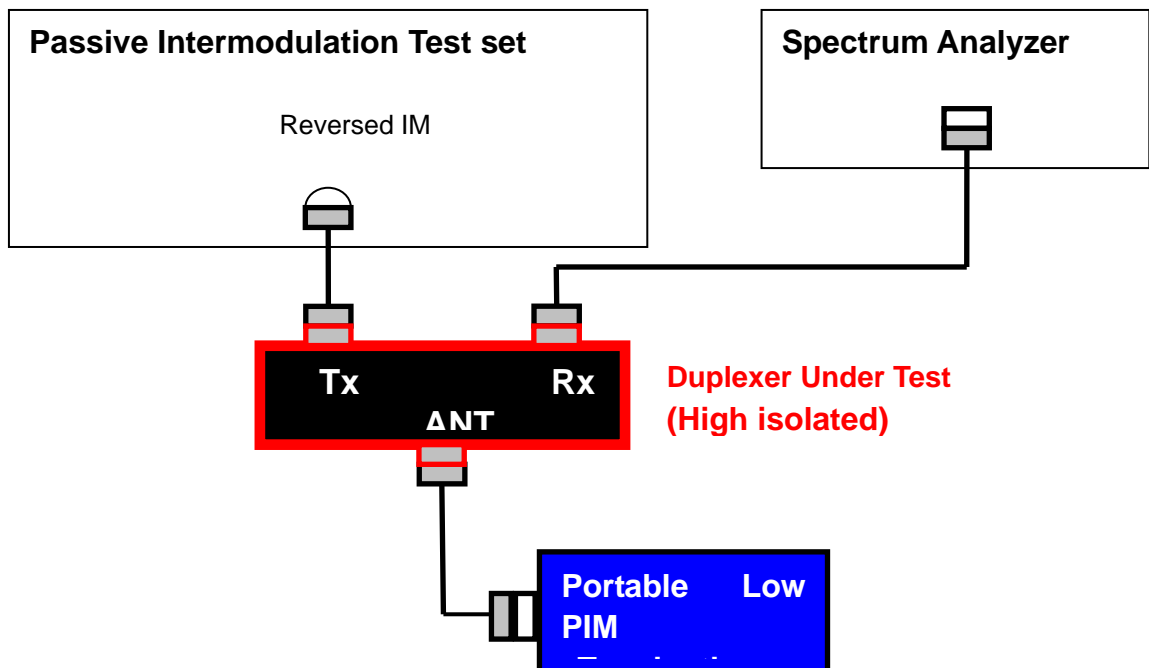

Fig 3-9 duplexer measurement

If isolation between Tx and Rx is not high enough, it is advised to insert a band-pass filter (has the same operating band as Rx of duplexer) between Rx of duplexer and receiver. The band-pass filter can prevent receiver from receiving power coupled from Tx due to the low isolation.

Fig 3-10 illustrates the solution.

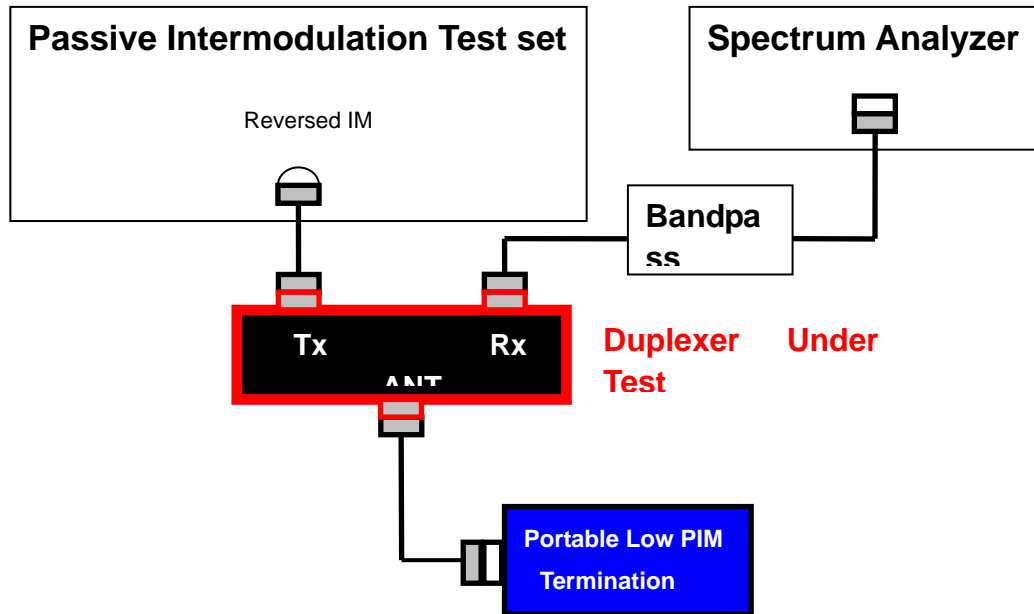

Fig. 3-10 duplexer measurement

## Intermodulation Analyzer Technical Data

### General

Detected Signal:	Refl. 3 <sup>rd</sup> , 5 <sup>th</sup> and 7 <sup>th</sup> order intermodulation product
Test Signals:	
- Power at test port:	2 x up to min. +36 ... +45 dBm (typ. 46dBm)
- Output power accuracy:	±0.35dB
- Display:	Display the real-time measurement results on the screen
- Storage:	Store measurement results on USB Stick or external contr. PC
- IM-level (2x 43dBm, S/N = 10 dB) :	< -168 dBc max. over 90% of IM frequency band

### TX and RX frequency range / power

IM-07S:	TX: 745 ... 793 MHz	RX: 697 ... 730 MHz
IM-08S:	TX: 869 ... 894 MHz	RX: 824 ... 849 MHz
IM-09S:	TX: 925 ... 960 MHz	RX: 880 ... 915 MHz
IM-18S:	TX: 1805 ... 1880 MHz	RX: 1710 ... 1785 MHz
IM-19S:	TX: 1930 ... 1990 MHz	RX: 1850 ... 1910 MHz
IM-21S:	TX: 2110 ... 2170 MHz	RX: 1920 ... 2060 MHz
Output power within TX frequency range at test port connector:	2 x up to min. +36 ... +45 dBm (typ. 46dBm)	
Includes Integrated Synthesizer		

### Receiver

Average Noise Floor:	-135 dBm, maximum (0 dB S/N, "Max." averaging)
Dynamic Range:	100 dB, typical
Accuracy:	0.1 dB/10 dB relative to a -75 dBm reference
Maximum Operational Input Power:	-40 dBm RMS (transmit and receive frequencies comb.)
Maximum Survival Input Power:	15 dBm combined power, at any frequency

### IM-SOFT System Software

Operational Modes	- Firmware or remote controlled by external PC
Measurement Modes	- Two Tone measurement mode
	- Sweep measurement mode
Remote Control	- USB B

### Temperature Range

Max. allowable operating temperature range:	+ 5 ... 40°C
Recommended operating temperature range:	+ 15 ... +25°C

Power Supply

100 - 240 VAC, 50/60 Hz  
10.0 A – 5.0A

Warm-up Time

Minimum 15 minutes for specified accuracy

Dimensions and Weight

450mm × 400mm × 200mm  
about 21,5 kg

Rosenberger  
Hochfrequenztechnik GmbH & Co.KG  
P.O.Box 1260  
D-84526 Tittmoning  
Tel: +49-86 84-18-0      Fax: +49-86 84-18-499  
E-Mail: [info@rosenberger.de](mailto:info@rosenberger.de)      Web: [www.rosenberger.com](http://www.rosenberger.com)

Rosenberger Asia Pacific Electronic Co., Ltd.  
No.3, Anxiang Road, Block B  
Tianzhu Airport Industrial Zone  
Beijing 101300  
PR China  
Tel: +86-10-80 48 1995  
Fax: +86-10-80 48 2438  
E-Mail: [info@rosenbergerAP.com](mailto:info@rosenbergerAP.com)