

HIGH-SPEED MULTISERVICE TEST MODULE

Power Blazer

88000 Series

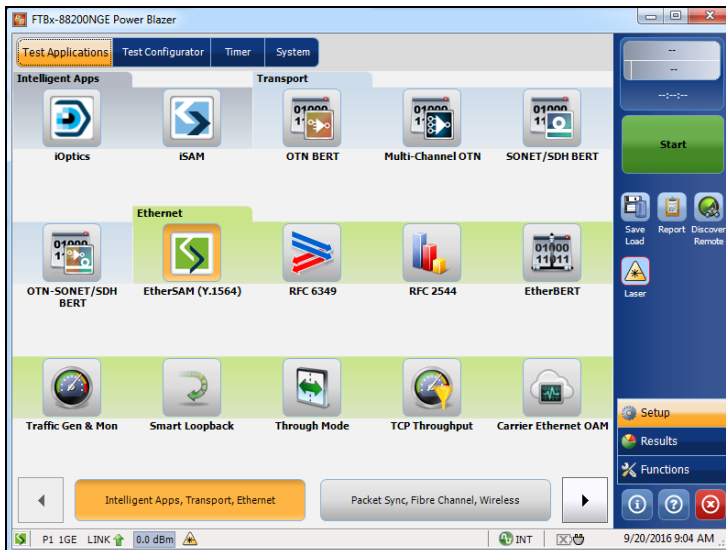

Copyright © 2014–2018 EXFO Inc. All rights reserved. No part of this publication may be reproduced, stored in a retrieval system or transmitted in any form, be it electronically, mechanically, or by any other means such as photocopying, recording or otherwise, without the prior written permission of EXFO Inc. (EXFO).

Information provided by EXFO is believed to be accurate and reliable. However, no responsibility is assumed by EXFO for its use nor for any infringements of patents or other rights of third parties that may result from its use. No license is granted by implication or otherwise under any patent rights of EXFO.

EXFO's Commerce And Government Entities (CAGE) code under the North Atlantic Treaty Organization (NATO) is 0L8C3.

The information contained in this publication is subject to change without notice.

Trademarks

EXFO's trademarks have been identified as such. However, the presence or absence of such identification does not affect the legal status of any trademark.

Units of Measurement

Units of measurement in this publication conform to SI standards and practices.

Patents

Dual Test Set/Bi-Directional testing is protected by US patent 9,432,206 and equivalents in other countries.

Feature(s) of this product is/are protected by one or more of: US design patent D798,171 and equivalent(s) in other countries.

May 2, 2018

Document version: 4.0.0.1

Contents

Certification Information	x
1 Introducing the High-Speed Multiservice Test Module	1
Features	1
Technical Specifications	2
Conventions	3
2 Safety Information	5
Additional Laser Safety Information	7
Installation Instruction Warnings	8
3 Getting Started	11
Inserting and Removing Test Modules	11
Inserting and Removing Transceiver Adaptors (TA)	12
Turning On the Unit	14
Starting the Module Application	15
4 Physical Interfaces and LEDs	17
Port Availability on the 88000 Series	20
Transceivers	24
RJ45	24
BNC	25
SMB	25
LEDs	25
5 Graphical User Interface Overview	27
Main Application Window	27
Main Window	27
Navigation Buttons	28
Status Bar	28
Title Bar	31
Global Indicator	31
Test Control	33
Test Menu	33
Application Buttons	34
Zoomed-In/Zoomed-Out Views	37
Arrow Buttons	37
Keyboard Usage	38

6 Test Setup - Test Applications	41
iOptics	42
iSAM	43
Multi-Channel OTN	44
OTN BERT	45
OTN-SONET/SDH BERT	47
SONET/SDH BERT	50
DSn/PDH BERT	53
SONET/SDH - DSn/PDH BERT	55
NI/CSU Emulation	58
EtherSAM (Y.1564)	59
RFC 2544	61
RFC 6349	63
EtherBERT	64
Traffic Gen & Mon	66
Smart Loopback	68
Through Mode	70
TCP Throughput	71
Carrier Ethernet OAM	72
Cable Test	74
1588 PTP	75
SyncE	76
Wander	77
FC BERT	78
CPRI/OBSAI BERT	79
7 Selecting and Starting a Test	81
Intelligent Apps	81
Transport Test Applications	85
Ethernet Test Applications	87
Sync Test Applications	89
Fibre Channel Test Application	91
Wireless Test Application	93

8 Test Setup - Test Configurator, Timer, and System	95
Test Configurator Overview	100
Modify Structure Button	108
Signal Auto-Detect	131
1588 PTP	132
BERT and Unframed BERT	139
Cable Test	145
CFP4/CFP8/QSFP/SFP/SFP+/SFP28	147
Clock	148
EtherBERT, FC BERT, BERT (CPRI/OBSAI), and Unframed BERT	155
EtherSAM - Burst	163
EtherSAM - Global	165
EtherSAM - Ramp	169
External Reference	171
Fibre Channel	172
Frequency	175
FTFL/PT and PT	177
GFP-F/GFP-T	181
Interface (Ethernet, Packet Sync, Fibre Channel, and Wireless)	182
Labels	196
Link OAM	198
Local Details (iSAM)	200
MAC/IP/UDP	204
Network	220
Network Details (iSAM)	226
ODU Channels - Global	237
Optical Device Under Test (iOptics)	245
Remote Details (iSAM)	248
RFC 2544 - Global	252
RFC 2544 - Subtests	255
RFC 6349	264
S-OAM and MPLS-TP OAM	267
Services - Global	277
Services - Profile	280
Signal (Transport)	287
Signal - Signal Configuration (DSn/PDH)	294
Signal - Signal Configuration (OTN)	302
Signal - Signal Configuration (SONET/SDH)	307
Smart Loopback	311
Streams - Global	313
Streams - Profile	315
SyncE	323

System	325
TA-SFP28	326
TCP Throughput	327
Test Sequence (iOptics)	329
Timer	330
Traces (OTN)	332
Traces (SONET/SDH)	336
Wander	338
9 Test Results	341
Alarms/Errors Overview	344
Analysis - MTIE/TDEV	417
Analysis - Time Error / Time Interval Error	419
FTFL/PT and PT	421
GFP-F/GFP-T	423
Graph (RFC 2544)	426
Labels	427
Link OAM	428
Logger	432
Messages	434
MPLS	436
OTL-SDT	437
Performance Monitoring	439
PTP Stats	446
Quality Level (1588 PTP)	448
Quality Level (SyncE)	450
S-OAM and MPLS-TP OAM	452
SDT (Multi-Channel OTN)	457
Service Configuration - Burst	459
Service Configuration - Ramp	460
Service Performance	462
Streams - Frame Loss / Out-of-Sequence	464
Streams - Jitter	464
Streams - Latency	465
Streams - Throughput / Customer Frame Throughput	466
Summary	467
Summary (1588 PTP)	474
Summary (Cable Test)	479
Summary (EtherSAM)	485
Summary (FC BERT)	488
Summary (iOptics)	491
Summary (iSAM)	493

Summary (Link OAM)	497
Summary (Multi-Channel OTN)	499
Summary (NI/CSU Emulation)	501
Summary (RFC 2544)	502
Summary (RFC 6349)	505
Summary (S-OAM and MPLS-TP OAM)	508
Summary (SyncE)	513
Summary (TCP Throughput)	516
Summary (Traffic Gen & Mon)	519
Summary (Wander)	521
Traces - OTN	525
Traces - SONET/SDH	527
Traffic - Ethernet	528
Traffic - Flow Control	531
Traffic - Graph	533
Traffic - OAM, S-OAM, and MPLS-TP OAM	534
Window Sweep	536
WIS	537
10 Test Functions	539
40/100G/400G Advanced - CFP4/CFP8/QSFP Control	542
40/100G/400G Advanced - Lanes Mapping & Skew	545
APS	550
Client Offset	553
FDL - Bit-Oriented Message	556
FDL - Performance Report Message	560
FEAC	563
Filters	567
Packet Capture	571
GCC BERT	577
GMP	579
OH - GFP-F/GFP-T	580
OH - OTN	585
OH - SONET/SDH	591
Ping & Trace Route	605
Pointer Adjustment	610
RTD	620
RTD/RTT (CPRI/OBSAI Framed L2)	623
S-OAM Link Trace	626
Signaling Bits	628
Spare Bits	630
Traffic Scan	632

11 Test Control	635
Discover Remote Button	636
Inject Button	639
Laser Button	639
Lpbk Tool Button (Loopback Tool)	640
Report Button	647
Reset Button	652
Save/Load Button	653
Start/Stop TX Button	657
12 Power Failure Recovery	659
Enabling Power Failure Recovery	660
When Using the Test Timer	661
13 Maintenance	663
Cleaning LC/SC/MPO-24 Connectors	664
Battery Safety Information	664
Recalibrating the Unit	665
Recycling and Disposal	666
14 Troubleshooting	667
Solving Common Problems	667
Contacting the Technical Support Group	668
Transportation	668
15 Warranty	669
General Information	669
Liability	670
Exclusions	671
Certification	671
Service and Repairs	672
EXFO Service Centers Worldwide	673
A Specifications	675

B Glossary	677
Acronym List	677
10G Ethernet Client	694
1588 PTP	697
CPRI	703
Ethernet Cables	708
G.709 Optical Transport Network (OTN)	710
Generic Framing Procedure (GFP)	727
MPLS Labels	739
OBSAI	740
SONET/DSn/SDH/PDH	745
SyncE	755
Unicast/Multicast Addresses for Ethernet OAM	757
VLAN ID and Priority	758
C Remote ToolBox	759
Overview	759
Remote ToolBox Installation	761
Starting and Using the Remote ToolBox Application	762
Applications for...	764
Index	765

Certification Information

North America Regulatory Statement

This unit was certified by an agency approved in both Canada and the United States of America. It has been evaluated according to applicable North American approved standards for product safety for use in Canada and the United States.

Electronic test and measurement equipment is exempt from FCC part 15, subpart B compliance in the United States of America and from ICES-003 compliance in Canada. However, EXFO Inc. makes reasonable efforts to ensure compliance to the applicable standards.

The limits set by these standards are designed to provide reasonable protection against harmful interference when the equipment is operated in a commercial environment. This equipment generates, uses, and can radiate radio frequency energy and, if not installed and used in accordance with the user guide, may cause harmful interference to radio communications. Operation of this equipment in a residential area is likely to cause harmful interference in which case the user will be required to correct the interference at his own expense.

Modifications not expressly approved by the manufacturer could void the user's authority to operate the equipment.

European Community Declaration of Conformity

Warning: This is a class A product. In a domestic environment, this product may cause radio interference in which case the user may be required to take adequate measures.

The full text of the EU declaration of conformity is available at the following Internet address: *www.exfo.com/library*.

Laser



Your instrument is a Class 1 laser product in compliance with standards IEC 60825-1: 2007/2014 and 21 CFR 1040.10, except for deviations pursuant to Laser Notice No. 42, dated December 18, 1989.

1 Introducing the High-Speed Multiservice Test Module

Turnkey field-test solution for deploying, validating, and troubleshooting networks up to 400G.

Features

Features		Model			
		88200NGE	88260	88400NGE	8870/8880
Intelligent Apps.	iOptics	X	-	X	X
	iSAM	X	-	-	X
Transport	Multi-Channel OTN	X	-	-	-
	OTN BERT	X	-	-	X
	SONET/SDH BERT	X	-	-	X
	OTN-SONET/SDH BERT	X	-	-	X
	DSn/PDH BERT	-	-	-	X
	SONET/SDH - DSn/PDH BERT	-	-	-	X
	NI/CSU	-	-	-	X
Ethernet	EtherSAM (Y.1564)	X	-	-	X
	RFC 6349	X	-	-	X
	RFC 2544	X	X	-	X
	EtherBERT	X	X	X	X
	Traffic Gen & Mon	X	X	-	X
	Smart Loopback	X	X	-	X
	Through Mode	X	-	-	X
	TCP Throughput	X	-	-	X
	Carrier Ethernet OAM	X	-	-	X
	Cable Test	-	-	-	X

Introducing the High-Speed Multiservice Test Module

Technical Specifications

Features		Model			
		88200NGE	88260	88400NGE	8870/8880
Packet Sync	1588 PTP	X	-	-	X
	SyncE	X	-	-	X
	Wander	-	-	-	8880
Fibre Channel	FC BERT	X	-	-	X
Wireless	CPRI/OBSAI BERT	X	-	-	X

Technical Specifications

To obtain this product's technical specifications, visit the EXFO Web site at www.exfo.com.

Conventions

Before using the product described in this guide, you should understand the following conventions:



WARNING

Indicates a potentially hazardous situation which, if not avoided, could result in *death or serious injury*. Do not proceed unless you understand and meet the required conditions.



CAUTION

Indicates a potentially hazardous situation which, if not avoided, may result in *minor or moderate injury*. Do not proceed unless you understand and meet the required conditions.



CAUTION

Indicates a potentially hazardous situation which, if not avoided, may result in *component damage*. Do not proceed unless you understand and meet the required conditions.



IMPORTANT

Refers to information about this product you should not overlook.

2 **Safety Information**



WARNING

Do not install or terminate fibers while a light source is active. Never look directly into a live fiber and ensure that your eyes are protected at all times.



WARNING

The use of controls, adjustments and procedures, namely for operation and maintenance, other than those specified herein may result in hazardous radiation exposure or impair the protection provided by this unit.



WARNING

If the equipment is used in a manner not specified by the manufacturer, the protection provided by the equipment may be impaired.



WARNING

Use only accessories designed for your unit and approved by EXFO. For a complete list of accessories available for your unit, refer to its technical specifications or contact EXFO.



IMPORTANT



When you see the following symbol on your unit , make sure that you refer to the instructions provided in your user documentation. Ensure that you understand and meet the required conditions before using your product.



IMPORTANT



When you see the following symbol on your unit , it indicates that the unit is equipped with a laser source, or that it can be used with instruments equipped with a laser source. These instruments include, but are not limited to, modules and external optical units.



IMPORTANT

Other safety instructions relevant for your product are located throughout this documentation, depending on the action to perform. Make sure to read them carefully when they apply to your situation.

Additional Laser Safety Information

This product employs Class 1 Laser transceivers.



WARNING

When the LASER LED is on or flashing, the module is transmitting an optical signal on the transceiver ports.

Note: *Refer to the platform's user guide for additional test equipment safety information and ratings.*

Safety Information

Installation Instruction Warnings

Installation Instruction Warnings



CAUTION

When you use the unit outdoors, ensure that it is protected from liquids, dust, direct sunlight, precipitation, and full wind pressure.



CAUTION

Except for the dual Bantam connector and the RJ-48C port, all telecom (electrical) interfaces are SELV (Safety Extra Low Voltage) circuitry intended for intra-building use only.



CAUTION

For the dual Bantam connector and the RJ-48C ports, use only No. 26 AWG or larger telecommunication line cord to reduce the risk of fire.



CAUTION

No user serviceable parts are contained inside. Contact the manufacturer regarding service of this equipment.



IMPORTANT

All wiring and installation must be in accordance with local building and electrical codes acceptable to the authorities in the countries where the equipment is installed and used.



WARNING

Use only accessories designed for your unit and approved by EXFO.



CAUTION

Electrostatic Discharge (ESD) Sensitive Equipment:

Plug-in modules can be damaged by static electrical discharge. To minimize the risk of damage, dissipate static electricity by touching a grounded unpainted metal object

- before removing, inserting, or handling the module.
- before connecting or disconnecting cables to/from the module.
- before inserting or removing a transceiver to/from the module.

3 Getting Started

If the module has been purchased at the same time as the platform, the module is pre-installed with the appropriate software version.

Number of Dedicated Modules per Platform

The following table lists the maximum number of dedicated modules that can run simultaneously on each platform.

Platform	88200NGE	88260NGE	88400NGE	8870/8880
FTB-2	NA	NA	NA	2
FTB-2 Pro	2	2	NA	2
FTB-4 Pro	4	4	1 ^a	4
LTB-8	8	8	2	8

- a. The platform needs to be connected to a power outlet since this module requires too much power to run on battery power.

Inserting and Removing Test Modules



CAUTION

There is no need to turn off your unit before inserting or removing FTBx- modules.

However, inserting/removing modules without following the instructions provided in the platform user documentation could result in the following consequences, depending on the operation underway when the modules are inserted/removed:

- unexpected behavior of the test applications,
- instability of the system,
- or cause irreparable damage to your modules.

Note: Refer to the platform user guide for more information on how to insert/remove a module into/from the platform.

Inserting and Removing Transceiver Adaptors (TA)



CAUTION

There is no need to turn off your unit before inserting or removing TA modules.

However, inserting/removing TA modules without following the instructions provided in this user documentation could result in the following consequences, depending on the operation underway when the modules are inserted/removed:

- unexpected behavior of the test applications,
- instability of the system,
- or cause irreparable damage to your TA modules.

To insert a TA module into the FTBx-88260 module:

1. Position the FTB-x-88260 module so that its faceplate is facing you.
2. Remove the FILLER (protective cover) from the FTBx-88260.
 - Turn the retaining screw counterclockwise until it is loose.
 - Hold the FILLER by the handle and/or the retaining screw and pull it out.

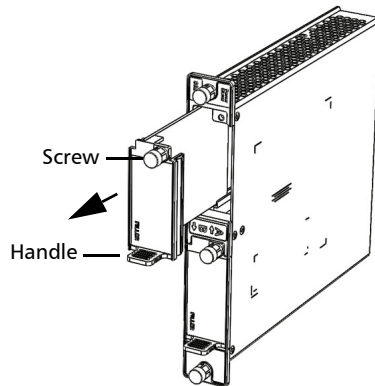

- 3.** Remove the TA module from its packaging:

3a. Turn the retaining screw counterclockwise until it is loose.

3b. Hold the TA module by the handle and/or the retaining screw (NOT by the connectors) and pull it out. Don't throw away the TA packaging, it is recommended to insert the TA module into its packaging when carrying the TA outside the FTBx-88260 module.

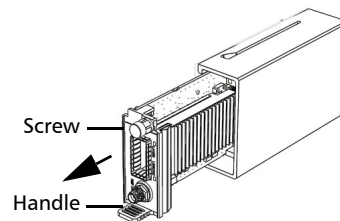

- 4.** Insert the TA module into the FTBx-88260 module:

4a. Take the TA module and place it so that the connector pins are at the back as shown below.

The identification sticker and the protruding edges are on the left side.

4b. Insert the protruding edges of the module into the grooves of the receptacle's module port.

4c. Push the TA module all the way to the back of the receptacle by pressing firmly on the left edge of the TA module until it is fully inserted.

4d. Turn the retaining screw clockwise until it is tightened.

This will secure the TA module into its "seated" position.

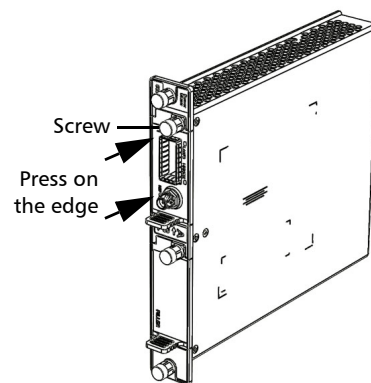
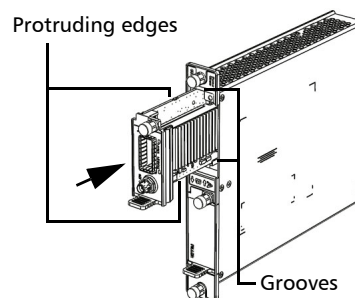

Getting Started

Turning On the Unit

To remove a TA module from the FTBx-88260 module:

1. Position the FTB-x-88260 module so that its faceplate is facing you.
2. Turn the retaining screw counterclockwise until it is loose.
3. Hold the TA module by the handle and/or the retaining screw (NOT by the connectors) and pull it out.

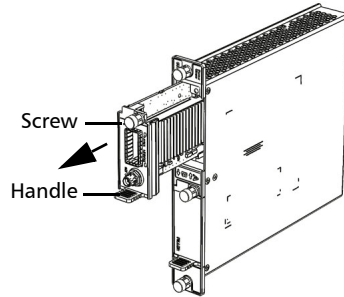

CAUTION

Pulling out a TA module by its connectors could seriously damage both the TA module and connectors. Always pull out a TA module by its retaining screw, and/or the handle.

4. Cover the empty FTBx-88260's receptacle with the supplied FILLER.



CAUTION

Failure to reinstall the FILLER over an empty receptacle will result in ventilation problems.

Turning On the Unit

Turn on the platform. Refer to the platform user guide for more information.

Starting the Module Application

The module can be configured and controlled by starting the application(s) as described in the following table.

Module	Application	Comment
88200NGE 88260 88400NGE	Power Blazer	
8880 8870 ^a	Power Blazer OpticalRF ^b BBU-Emulation ^b	Only one application can run at once.

- a. Only the OpticalRF application is available on RTU-2.
- b. No supported on FTB-2.

To start the application:

From **ToolBox X** tap the desired application button.

Note: Refer to the respective user guides for more information on OpticalRF, and BBU-Emulation applications.

4 Physical Interfaces and LEDs

This section describes all connectors (ports) and LEDs available on the 88000 Series.



CAUTION

To prevent exceeding the maximum input/output power level, please refer to this product's technical specifications at www.exfo.com.

FTBx-88200NGE

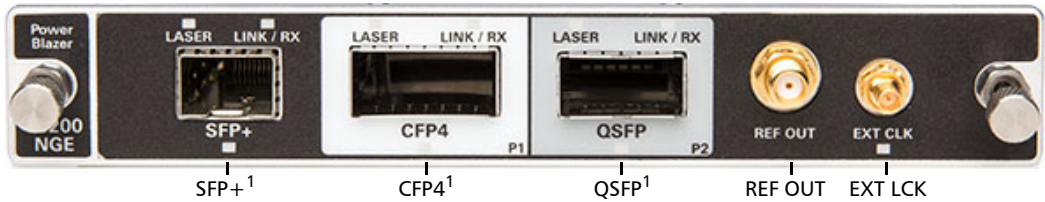

1. Laser radiation emitted from this port when LASER LED is on.

FTBx-88260 and TA-SFP28

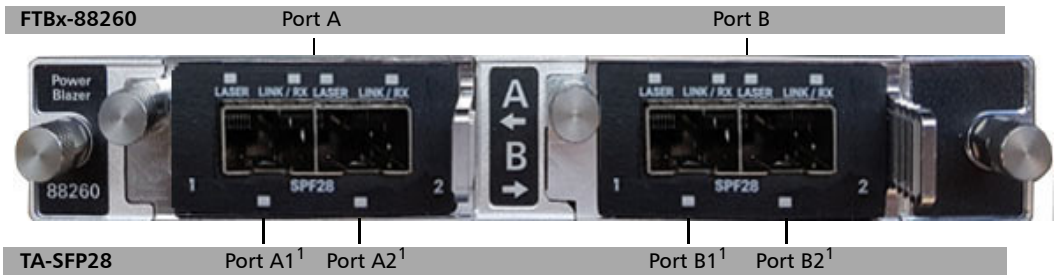

1. Laser radiation emitted from this port when LASER LED is on.

Physical Interfaces and LEDs

FTBx-88400NGE

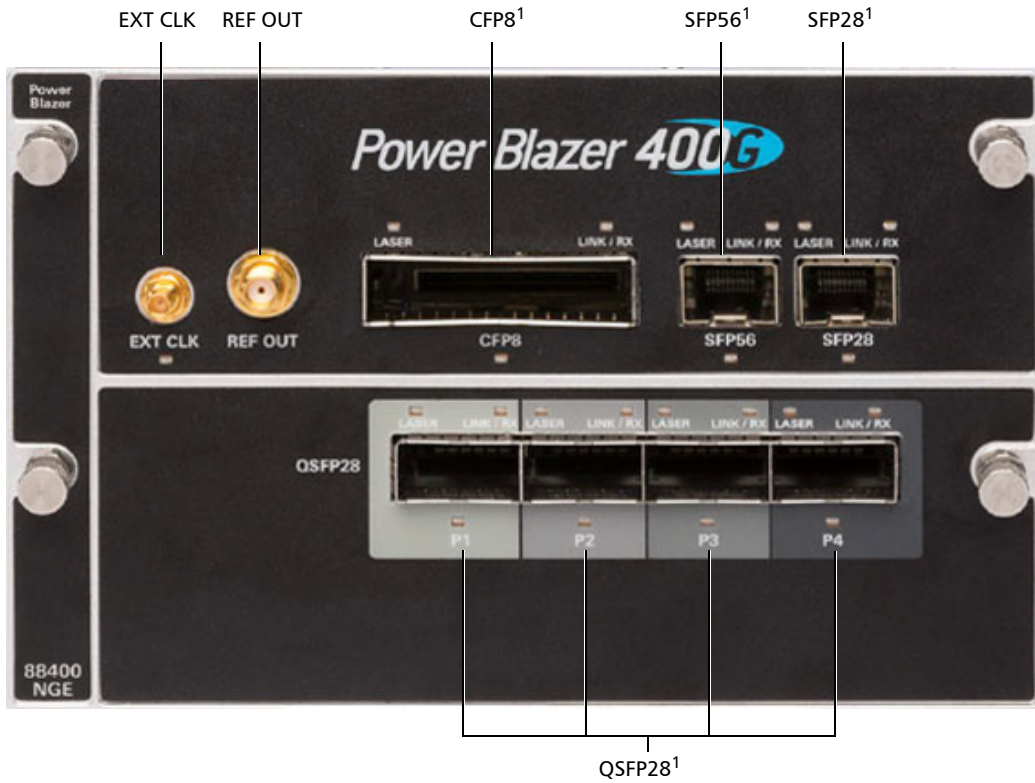

1. Laser radiation emitted from this port when LASER LED is on.

FTBx-8870/8880

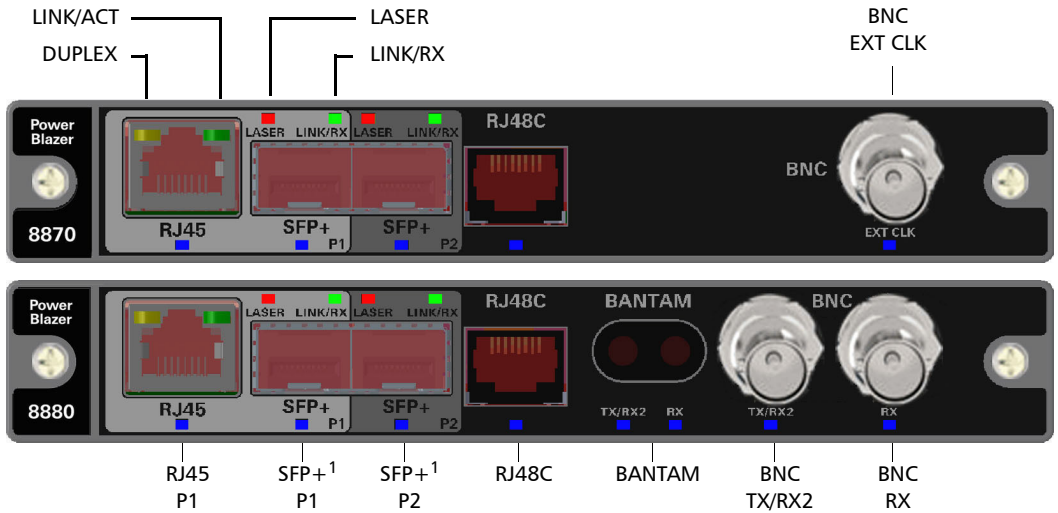

1. Laser radiation emitted from this port when LASER LED is on.

Physical Interfaces and LEDs

Port Availability on the 88000 Series

Port Availability on the 88000 Series

88200NGE

The following table shows the list of available ports as well as a description and the signals supported on the module.

Port Labelled	Description	Supported Signal(s)
SFP+	Optical IN/OUT port SFP/SFP+ transceiver	Ethernet 100/1000 Mbit/s, 10 Gbit/s optical Ethernet 10/100/1000 Mbit/s electrical (using active copper SFP) Fibre Channel 1X, 2X, 4X, 8X, 10X, 16X CPRI 1.2, 2.4, 3.1, 4.9, 6.1, 9.8 Gbit/s OBSAI 1.5, 3.1, 6.1 Gbit/s OC-1/STM-0, OC-3/STM-1, OC-12/STM-4, OC-48/STM-16, OC-192/STM-64 OTU1, OTU2, OTU1e, OTU2e, OTU1f, OTU2f.
CFP4	Optical IN/OUT port CFP4 transceiver ^a	Ethernet 100 Gbit/s OTU4
QSFP (QSFP+ or QSFP28)	Optical IN/OUT port QSFP+ transceiver ^b	Ethernet 40 Gbit/s OTU3e2, OTU3e1, OTU3
	Optical IN/OUT port QSFP28 transceiver ^a	Ethernet 100 Gbit/s OTU4
REF OUT	Electrical port SMA for eye diagram clock signal generation	
EXT CLK	Electrical port SMB for external clock synchronization	DS1/1.5M, E1/2M, 2MHz, 1PPS ^c

- Only OTU4 (4 Lanes) and 100GE (4 Lanes) are supported.
- Only parallel interfaces are supported.
- Available for **Dual Test Set - One-Way Latency** measurement mode.

88260

The following table shows the list of Transceiver Adapter (TA) supported on each port of the FTBx-88260 module.

Port Labelled	Description	Supported Transceiver Adapter (TA)
A	TA left port	TA-SFP28
B	TA right port	TA-SFP28

The following table shows the list of port as well as a description and the signals supported on each Transceiver Adapter (TA).

TA	Description	Port Labelled ^a	Supported Signal(s)
TA-SFP28	Dual SFP28	1	Ethernet 25 Gbit/s optical
		2	

- a. The ports are listed/referred as follows in the GUI: **Port**, FTBx-88260's port (**A** or **B**), TA port (**1** or **2**), and connector type; for example **Port A1 - SFP28**.

Physical Interfaces and LEDs

Port Availability on the 88000 Series

88400NGE

The following table shows the list of available ports as well as a description and the signals supported on the module.

Port Labelled	Description	Supported Signal(s)
SFP28 ^a	Optical IN/OUT port SFP28 transceiver	Ethernet 100/1000 Mbit/s, 10 Gbit/s, 25 Gbit/s optical
SFP56 ^a	Optical IN/OUT port SFP56 transceiver	Ethernet 50 Gbit/s
QSFP28 ^a (P1, P2, P3, and P4)	Optical IN/OUT port QSFP28 transceiver	Ethernet 40 Gbit/s, 100 Gbit/s
CFP8	Optical IN/OUT port CFP8 transceiver	Ethernet 400 Gbit/s
REF OUT	Electrical port SMA for eye diagram clock signal generation	
EXT CLK ^a	Electrical port SMB for external clock synchronization	DS1/1.5M, E1/2M, 2MHz, 1PPS

a. Future use.

8870/8880

The following table shows the list of available ports as well as a description and the signals supported for each module.

Connector	Labelled	Description and supported signal(s)	Module	
			8870	8880
Bantam	BANTAM TX/RX2 RX	TX and RX: DS1/1.5M, E1/2M RX2: DS1/1.5M	-	X
		Clock IN/OUT: DS1/1.5M, E1/2M, 2 MHz		
BNC	BNC TX/RX2	TX: E1/2M, E3/34M, DS3/45M, STS-1e/STM-0e/52M, E4/140M, STS-3e/STM-1e/155M RX2: DS3, 2 MHz, 10 MHz	-	X
		Clock OUT: DS1/1.5M, E1/2M, 2 MHz		
	BNC RX	E1/2M, E3/34M, DS3/45M, STS-1e/STM-0e/52M, E4/140M, STS-3e/STM-1e/155Mk, 1PPS	-	X
		Clock IN: DS1/1.5M, E1/2M, 2 MHz, 10 MHz, 1 PPS		
BNC EXT CLK	Clock IN: DS1/1.5M, E1/2M, 2 MHz, 1 PPS	X	-	
RJ45	RJ45 P1	Ethernet 10/100/1000 Mbit/s electrical	X	X
RJ48C	RJ48C	DS1/1.5M, E1/2M	X	X
		1PPS, 2 MHz, 10 MHz	-	X
		Clock IN: DS1/1.5M, E1/2M, 2 MHz	-	X
		Clock OUT: DS1/1.5M, E1/2M, 2 MHz	-	X
SFP/SFP+	SFP+ P1 or SFP+ P2	Ethernet 100 Mbit/s, 1000 Mbit/s, 10 Gbit/s LAN/WAN optical CPRI 1.2, 2.4, 3.1, 4.9, 6.1, 9.8 Gbit/s OBSAI 1.5, 3.1, 6.1 Gbit/s Fibre Channel 1X, 2X, 4X, 8X, 10X	X	X
	SFP+ P1	OC-1/STM-0, OC-3/STM-1, OC-12/STM-4, OC-48/STM-16, OC-192/STM-64 ^a OTU1, OTU2, OTU1e, OTU2e, OTU1f, OTU2f	X	X
	SFP+ P2	Ethernet 10/100/1000 Mbit/s electrical (using active copper SFP) ^b	X	X

- a. Port SFP+ P2 is used with OC-192/STM-64 in Decoupled (TX≠RX) mode.
b. Available as a second port when the test application requires two ports.

Transceivers

Carefully connect optical fibre cables to the transceiver IN and OUT ports. To ensure good signal quality, make sure that the optical fibre connector is fully inserted into the optical connector port.



CAUTION

To prevent exceeding the maximum input power level please use an attenuator when a loopback configuration is used.



CAUTION

Before inserting an optical module into the interface receptacle, inspect the receptacle to make sure nothing is inside.



WARNING

Use only EXFO supported transceivers. Refer to www.exfo.com for the list of supported transceivers. Using non-supported transceivers can affect the performance and accuracy of the test.

Note: *Do not replace the transceiver while the test is running to avoid distorting results. First stop the test, replace the transceiver, select the connector type (refer to Modify Structure Button on page 108), and then restart the test.*

RJ45

The electrical port is RJ45 for category 5 unshielded twisted pair (UTP). Refer to *Ethernet Cables* on page 708 for cable specifications.

BNC

Connector type is BNC for coaxial 75-ohm cable connection. An adapter cable (BNC to Bantam) is required for Bantam external clock connection (not supplied).

SMB

The connector type is SMB for coaxial 75-ohm cable connection. An adapter cable (SMB to Bantam) is required for Bantam connection (not supplied).

LEDs

- **LASER** red LED is on when the module is emitting an optical laser signal.
- **LINK/RX** green LED is on when the link is up, off when the link is down, and flashing when frames are transmitted and/or received.
- **DUPLEX** green LED is on for Full Duplex mode, off for Half Duplex mode, and flashing when collisions are detected.
- Port blue LED is on when this port is selected for the test, and flashing when this port is selected for clock input.

5 Graphical User Interface Overview

This chapter describes the Power Blazer Series graphical user interface.

Main Application Window

The following main application window is displayed when the Power Blazer application is started.

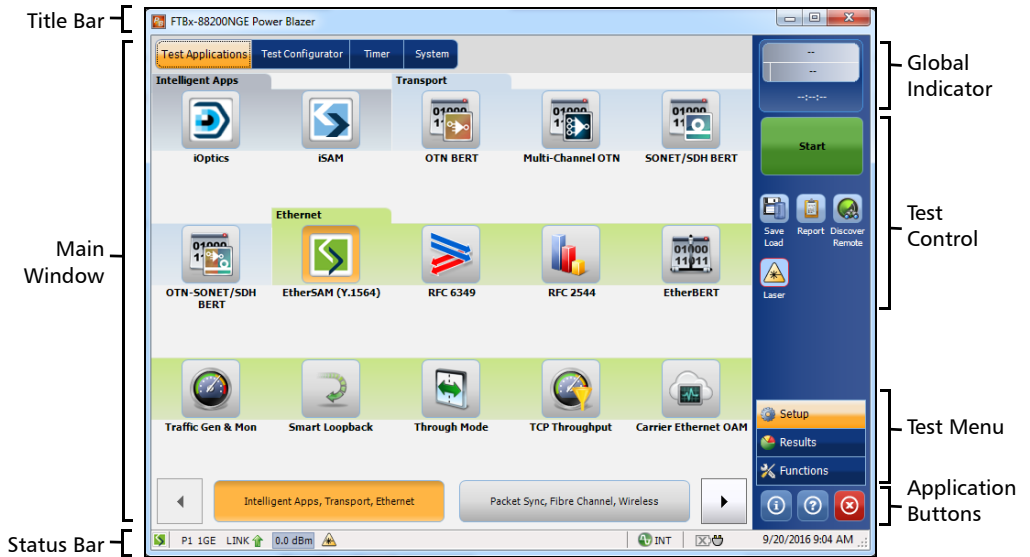

Main Window

The main window is used to setup a test and to view the test status and results.

Graphical User Interface Overview

Navigation Buttons





Navigation Buttons

Navigation buttons appear when there is not enough room on one page to display all available test applications. The left and right arrow buttons allow respectively accessing the previous or next window. The buttons in between the left and right arrow buttons allow directly selecting the window for the type of test application listed.

Status Bar







The status bar displays the following information.

Icon and/or text	Description	Test Application
Test icon	Icon representing the active test application.	All
P1, P2, P3, P4	Port identification number: Port x	All
A1, A2, B1, B2	Port identification number composed of the port of the FTBx-88260 module (A or B) and the TA port (1 or 2)	All (FTBx-88260)
TX/RX, TX, RX	Indicates the direction of the signal per port.	Transport, Wander (DS1/E1)
Interface/Signal	The interface or signal rate per port: 1GE Optical, 40G, OTU1, OTU2, OTU3, etc.	All
(BTS) or (RRH)	BTS: Emulation mode is Base Station RRH: Emulation mode is Remote Radio Head	CPRI/OBSAI BERT
LINK	Green arrow: Link up. Red arrow: Link down. Gray arrow: Awaiting incoming data to provide a status.	All CPRI/OBSAI BERT

Icon and/or text	Description	Test Application
PTP	<p>For G.8265.1:</p> <p>Green arrow: Signaling requests granted.</p> <p>Red arrow: Request denied, session canceled, or no reply.</p> <p>Gray arrow: Pending, inactive, or link down.</p> <p>Refer to <i>Negotiation Status</i> on page 475 for more information.</p> <p>For G.8275.1:</p> <p>Green arrow: Announce, Sync, and Follow-up are received according with their respective interval.</p> <p>Red arrow: Announce, Sync, or Follow-up are not received.</p> <p>Gray arrow: Pending.</p>	1588 PTP
ESMC	<p>Green arrow: ESMC valid information frame received.</p> <p>Red arrow: No ESMC valid information frames received.</p> <p>Gray arrow: Pending state.</p> <p>Refer to <i>ESMC Monitoring</i> on page 321 for more information.</p>	SyncE, Wander
Power level	<p>The received optical signal status:</p> <p>Green with "Power": Power level in range^a.</p> <p>Yellow: Power level out-of-range^b.</p> <p>Red with "LOS": Loss of signal^b.</p> <p>Red with "Power": Power level is close to damage.</p> <p>Gray: The operational range value is either not available or not supplied by the transceiver.</p>	All except Cable Test
	<p>Laser ON^b. The laser icon is not displayed when the laser is off^a. The laser icon is only displayed for optical interfaces. The laser is ON by default when the test is created. The laser control is not affected when turning off the laser by generating a LOS for example. Refer to <i>Laser Button</i> on page 643.</p>	All
	<p>The status of the received signal pattern per port:</p> <p>Green: Pattern is synchronized.</p> <p>Red: Loss of pattern.</p> <p>Gray: Test is not running (EtherBERT test or EoOTN client) or the No Pattern Analysis (Live) check box is selected.</p>	Transport EtherBERT Fibre Channel Wireless
	<p>Connection established between two testing units in Dual Test Set (DTS), EXFO Worx Interop, or in Loop Up mode.</p>	Ethernet
	<p>Connection not established between two testing units in Dual Test Set (DTS), EXFO Worx Interop, or in Loop Up mode.</p>	Ethernet

Graphical User Interface Overview

Status Bar

Icon and/or text	Description	Test Application
	Remote unit is busy (locked) in EXFO Worx Interop operation mode.	Ethernet
	Loopback Tool enabled on the port unused by the main test application.	Ethernet
	Clock synchronization signal clock. The clock icon is followed by the clock mode: INT for Internal, EXT for External RCV for Recovered, or BKP for Backplane. AUTO is displayed for dual port test when a different clock is used on each port. Green: Clock Synchronized. Red: Loss of clock.	Transport Ethernet Fibre Channel Wireless
	Indicates a manual change in the OH bytes transmitted. Not displayed when using the default OH values.	Transport
	Remote PC connection established with the Power Blazer.	N/A
	The test is in loopback mode. Not displayed when not in loopback mode.	NI-CSU Emulation
	Alarm/error is currently injected. Not displayed when there is no alarm/error injection.	Transport EtherBERT Carrier Ethernet OAM Fibre Channel Wireless

- a. For all lanes for parallel interface.
- b. For at least one lane for parallel interface.

The following status are also displayed:

- Battery/AC icons, available on FTB platforms, indicate the battery level and if the platform is connected to an AC power source. Refer to the platform user guide for more information.
- Date and Time indicate the current date and time.

Title Bar

The Title Bar displays the module's slot number in brackets, the software application name and the minimize, maximize, and close buttons.

Global Indicator

The global indicator area displays the global pass/fail verdict, global alarm, and the test duration.

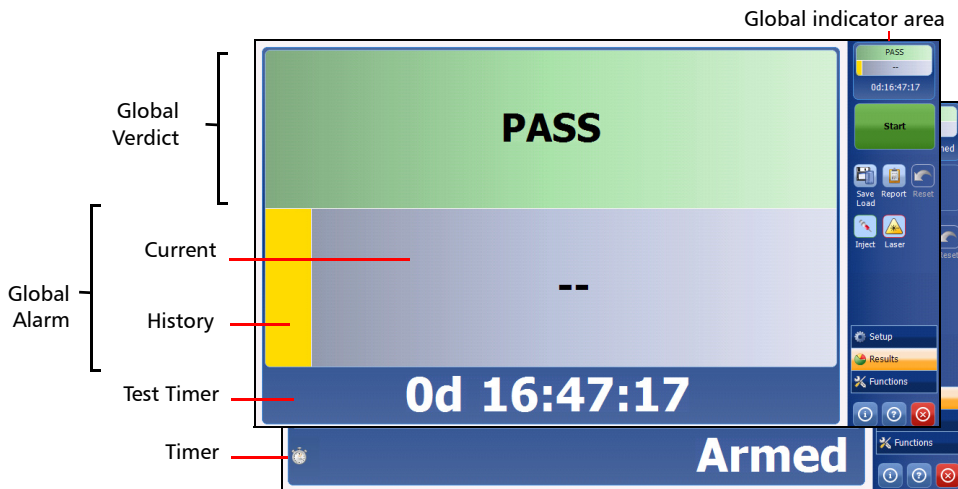

The global indicator area can be maximized for distant viewing. Tap anywhere within the global indicator area to display a maximized view. Tap again to exit the maximized view.

Graphical User Interface Overview

Global Indicator

Global Verdict

Reports the global test verdict status when supported by the test application and enabled (when applicable).

Verdict	Description
PASS	PASS is displayed with a green background when all result values meet the configured threshold criteria.
FAIL	FAIL is displayed with a red background when any result value does not meet the configured threshold criteria or when a specific alarm is detected (refer to each test application for additional information).
"--"	"--" is displayed with a gray background when at least one of the following conditions is met: <ul style="list-style-type: none">- Pass/Fail verdict is not enabled- there is no defined criterion- the test has not run yet.

Global Alarm

Indicates the current and history alarm/error status of the test.

Background color	Alarm/Error	Text displayed	Description
Gray	Current	--	No test result available.
	History		
Green	Current	No Alarm	No alarm/error has occurred in the last second.
	History		No alarm/error has occurred during the test.
Red	Current	Alarms or the name of the alarm.	An alarm/error occurred in the last second.
	History		
Amber	History		No current alarm/error but at least one alarm/error has occurred during the test.

Test Timer

The test timer without the timer icon indicates the time elapsed since the beginning of the test. No timer action is active. The test timer format is “day hour:minute:second”.

Timer

The timer icon with **Armed** indicates that a start time is active.

The timer icon with the Test Timer indicates that a duration and/or a stop time is active.

Test Control

Note: Refer to Test Control on page 635 for more information.

Test Menu

The test menu displays the following buttons:

- **Setup** allows configuring the selected test. Refer to *Test Setup - Test Configurator, Timer, and System* on page 95 for more information.
- **Results** allows viewing test results. Refer to *Test Results* on page 341 for more information.
- **Functions** allows configuring additional test functions (refer to *Test Functions* on page 539).

Graphical User Interface Overview

Application Buttons

Application Buttons

- **Help (?)** displays the help information related to the content of the active main window. It is also possible to navigate through the remainder of the help information.
- **Exit (x)** closes the application.
- **About (i)** mainly displays the product version details and technical support information.

Module Details button displays the module details such as its ID, Serial Number, Software Product Version, etc.

View Licence Agreement button displays the details of the product licence agreement.

Software Options button displays the list of software options.

Note: *For information on how to install and activate software options, refer to the platform User Guide. The Power Blazer application must be restarted once a new software option is installed in order to activate it.*

Software Option	Description
10electrical	Ethernet 10Base-T electrical interface
100optical	Ethernet 100Base-FX optical interface
100electrical	Ethernet 100Base-TX electrical interface
GigE_Electrical	Ethernet 1000Base-T electrical interface
GigE_Optical	Ethernet 1000Base-X optical interface
10G_LAN	Ethernet 10G LAN optical interface
10G_WAN	Ethernet 10G WAN optical interface
25GE	Ethernet 25G
40GE	Ethernet 40G
100GE	Ethernet 100G
400GE	Ethernet 400G
OTU4	Optical Transport Unit-4 (111.81 Gbit/s)
OTU3-e1-e2	Optical Transport Unit-3 Overclocked (44.571/44.583 Gbit/s)
OTU3	Optical Transport Unit-3 (43.018 Gbit/s)

Software Option	Description
OTU2-1f-2f	Optical Transport Unit-2 Overclocked (11.270/11.317 Gbit/s)
OTU2-1e-2e	Optical Transport Unit-2 Overclocked (11.049/11.096 Gbit/s)
OTU2	Optical Transport Unit-2 (10.7 Gbit/s)
OTU1	Optical Transport Unit-1 (2.7 Gbit/s)
40G	39.81312 Gbit/s (SONET/SDH)
9953M	9.953 Gbit/s (SONET/SDH)
2488M	2.488 Gbit/s (SONET/SDH)
622M	622 Mbit/s (SONET/SDH)
155M	155 Mbit/s (SONET/SDH)
52M	52 Mbit/s (SONET/SDH)
FC-1X	Fibre Channel 1X
FC-2X	Fibre Channel 2X
FC-4X	Fibre Channel 4X
FC-8X	Fibre Channel 8X
FC-10X	Fibre Channel 10X
FC-16X	Fibre Channel 16X
CPRI-1.2G	CPRI 1.2288 Gbit/s
CPRI	CPRI 2.4576 Gbit/s and 3.072 Gbit/s
CPRI-4.9G	CPRI 4.9152 Gbit/s
CPRI-6.1G	CPRI 6.144 Gbit/s
CPRI-9.8G	CPRI 9.8304 Gbit/s
DP-CPRI	Dual Port CPRI
OBSAI-1.5G	OBSAI 1.536 Gbit/s
OBSAI	OBSAI 3.072 Gbit/s
OBSAI-6.1G	OBSAI 6.144 Gbit/s
ETH-CAPTURE	Ethernet Frame Capture
ETH-OAM	Carrier Ethernet OAM test application
TRAFFIC-SCAN	Traffic Scan
LINK-OAM	Link OAM
TST-OAM	Test Over Service OAM
DUAL-PORT	Dual Port Test
DP_40-100GE	Dual Port at 40/100GE
RFC6349	RFC 6349 test application (up to 10GE)
RFC6349_40-100GE	RFC 6349 test application (40/100GE)
RFC6349-EXFOWorx	EXFO Worx Interop Operation Mode

Graphical User Interface Overview

Application Buttons

Software Option	Description
DTS-NAT	NAT traversal for DTS applications
ADV-FILTERS	Advanced filtering
MPLS	MPLS Encapsulation (up to 10GE)
MPLS_40-100GE	MPLS Encapsulation (40/100GE)
EoE	Ethernet over Ethernet Encapsulation (up to 10GE)
EoE_40-100GE	Ethernet over Ethernet Encapsulation (40/100GE)
PBBTE	Provider Backbone Bridge Encapsulation (up to 10GE)
PBBTE_40-100GE	Provider Backbone Bridge Encapsulation (40/100GE)
IPv6	Internet Protocol Version 6 (IPv6) (up to 10GE)
IPv6_40-100GE	Internet Protocol Version 6 (IPv6) (40/100GE)
ODU0	OTN ODU0
ODUMUX	ODU Multiplexing Payload Type 20 and 21
EoOTN	Ethernet over Optical Transport Network
ODUflex	OTN ODUflex
SONET	Synchronous Optical Network
SDH	Synchronous Digital Hierarchy
OTN-INTR-THRU	OTN Intrusive Through Mode
SONETSDH-INTR-THRU	SONET/SDH Intrusive Through Mode
MULTI-CH-OTN	Multi-Channel OTN Test Application
OTN-MIX-MAPPING	Mix-Mapping capability for Multi-Channel OTN
GCC-BERT	GCC BERT
TCM	Tandem Connection Monitoring STS/AU and VT/TU (SONET/SDH)
ETH-THRU	Through Mode Test Application
iOptics	Intelligent Pluggable Optic Test Application
iSAM	Intelligent Service Activation Methodology
CABLE_TEST	Cable Test Application
1588PTP	1588 Precision Time Protocol Test Application
G82751	ITU-T G.8275.1 Profile
SyncE	Synchronous Ethernet Test Application
Wander	Time Error / Wander Test Application
TCP-THPUT	TCP Throughput Test Application
DSn	Digital Signal
DS1-FDL	DS1/1.5M Facility Data Link
DS3-FEAC	DS3/45M Far-End Alarm and Control
DUALRX	Dual RX

Software Option	Description
DS3-G747	ITU-T Recommendation G.747
PDH	Plesiochronous Digital Hierarchy
NI-CSU	NI/CSU Emulation

Zoomed-In/Zoomed-Out Views







Some configuration and result blocks give access to zoomed views allowing more detailed configurations/results.

The block title contains the magnifier (+) icon when a zoomed view is available.

To zoom-in, tap the magnifier (+) icon or anywhere on the block.

To zoom-out, tap on the magnifier (-) icon or anywhere on the block title.

Arrow Buttons

	Moves to the top of the list.
	Moves one page up.
	Moves one line up.
	Moves one line down.
	Moves one page down.
	Moves to the end of the list.

Keyboard Usage

The GUI pops up different keyboards to modify data. Following are the usual keyboard keys:

- Left arrow moves the cursor one position to the left.
- Right arrow moves the cursor one position to the right.
- Up arrow increases the value by one.
- Down arrow decreases the value by one.
- **Del** deletes the value at the cursor position.
- **Back** deletes the value preceding the cursor position.
- **OK** completes data entry.
- **Cancel** closes the keyboard and discards the keyboard entry.
- **Previous...** allows the selection of previously configured values. This button is only available for certain fields like IP Address, MAC Address, etc.

Note: *For certain text fields, the GUI pops up or uses the unit's on-screen keyboard. Refer to the platform user guide for more information on how to use it.*

For full keyboard, the **Back**, **Del**, **Shift**, and **Space** bar keys have the same functionality as a regular PC keyboard.

For multiplexing keyboard, tap on all mapped signals that have to be added/removed to/from the test path.

A mapped signal with an orange background color is part of the test path.

A mapped signal with a gray background color is not part of the test path.

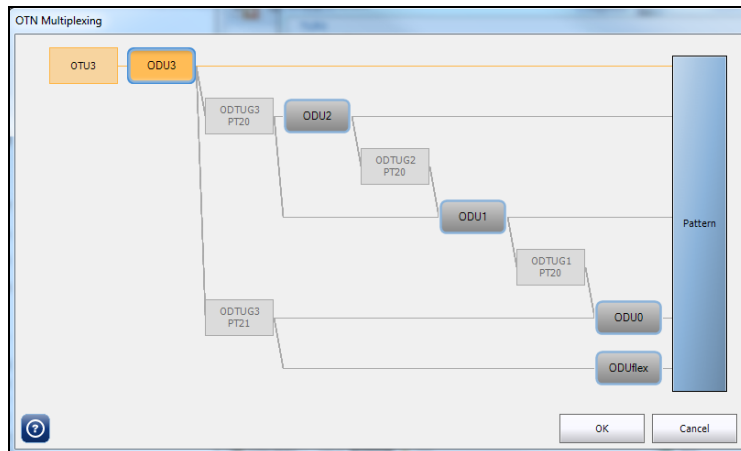

Graphical User Interface Overview

Keyboard Usage

The Trace message keyboard allows entering alphanumerical characters (ITU T.50) required for J0/J1/J2/TTI Trace fields. Tap the **Control Characters** button to access these characters.

ITU T.50 Characters					
b7 to b1	Character	Description	b7 to b1	Character	Description
000 0000	NUL	Null	001 0000	DLE	Data Link Escape
000 0001	SOH	Start Of Heading	001 0001	DC1	Device Control 1
000 0010	STX	Start of Text	001 0010	DC2	Device Control 2
000 0011	ETX	End of Text	001 0011	DC3	Device Control 3
000 0100	EOT	End Of Transmission	001 0100	DC4	Device Control 4
000 0101	ENQ	Enquiry	001 0101	NAK	Negative Acknowledge
000 0110	ACK	Acknowledge	001 0110	SYN	Synchronous idle
000 0111	BEL	Bell	001 0111	ETB	End of Transmission Block
000 1000	BS	Backspace	001 1000	CAN	Cancel
000 1001	HT	Horizontal Tabulation	001 1001	EM	End of Medium
000 1010	LF	Line Feed	001 1010	SUB	Substitute character
000 1011	VT	Vertical Tabulation	001 1011	ESC	Escape
000 1100	FF	Form Feed	001 1100	IS4	Information Separator 4
000 1101	CR	Carriage Return	001 1101	IS3	Information Separator 3
000 1110	SO	Shift-Out	001 1110	IS2	Information Separator 2
000 1111	SI	Shift-In	001 1111	IS1	Information Separator 1

6 Test Setup - Test Applications

The Power Blazer offers the following test applications.

Type	Application	Available on				Page
		88200NGE	88260	88400NGE	8870 / 8880	
Intelligent Apps	<i>iOptics</i>	X	-	X	X	42
	<i>iSAM</i>	X	-	-	X	43
Transport	<i>OTN BERT</i>	X	-	-	X	45
	<i>Multi-Channel OTN</i>	X	-	-	-	44
	<i>SONET/SDH BERT</i>	X	-	-	X	50
	<i>OTN-SONET/SDH BERT</i>	X	-	-	X	47
	<i>DSn/PDH BERT</i>	-	-	-	X	53
	<i>SONET/SDH - DSn/PDH BERT</i>	-	-	-	X	55
	<i>NI/CSU Emulation</i>	-	-	-	X	58
Ethernet	<i>EtherSAM (Y.1564)</i>	X	-	-	X	59
	<i>RFC 6349</i>	X	-	-	X	63
	<i>RFC 2544</i>	X	X	-	X	61
	<i>EtherBERT</i>	X	X	X	X	64
	<i>Traffic Gen & Mon</i>	X	X	-	X	66
	<i>Smart Loopback</i>	X	X	-	X	68
	<i>Through Mode</i>	X	-	-	X	70
	<i>TCP Throughput</i>	X	-	-	X	71
	<i>Carrier Ethernet OAM</i>	X	-	-	X	72
	<i>Cable Test</i>	-	-	-	X	74
Sync	<i>1588 PTP</i>	X	-	-	X	75
	<i>SyncE</i>	X	-	-	X	76
	<i>Wander</i>	-	-	-	8880	77
Fibre Channel	<i>FC BERT</i>	X	-	-	X	78
Wireless	<i>CPRI/OBSAI BERT</i>	X	-	-	X	79

iOptics

iOptics test application provides a quick assessment of the proper operation of an optical transceiver before using it in a network or test environment. The validation is done by running sub-tests in addition to monitoring transceiver power consumption and temperature. Result and verdict are reported for each sub-test and monitoring task. Transceiver's manufacturing information is also automatically collected.

A fiber loopback patch cord is required to perform the test with applicable attenuation included to protect the optical device. Bidirectional (single fiber) transceivers are not supported since the iOptics test requires a loopback.

- Typical iOptics test application:

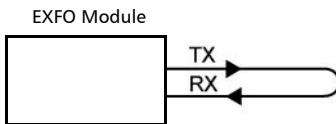

- Supported Interfaces/Rates: 40G/100G/OTU3/OTU3e1/OTU3e2/OTU4 parallel interfaces and all serial interfaces up to 10G/OTU2f (refer to **Rate** on page 245 for more information).

iSAM

iSAM is a simplified version of EtherSAM that is centered around addressing turn-up of E-Line circuits (EVC). The objective of the test is to validate Carrier Ethernet-based services key performance indicators defined in MEF: Frame Delay (FD), Inter-Frame Delay Variation (IFDV), and Frame Loss Ratio (FLR). In addition the RFC 6349 subtest can be enabled to validate that the Ethernet service is able to properly carry TCP traffic.

The **iSAM** test has to be executed in conjunction with a remote module. The remote module can be either in loopback configuration for unidirectional testing or in EtherSAM **Dual Test Set** mode for bidirectional testing.

The **Dual Test Set** test allows bi-directional testing between two compatible modules providing independent results for each test direction. The results from local-to-remote and remote-to-local are available on the local testing unit.

➤ Typical iSAM test applications:

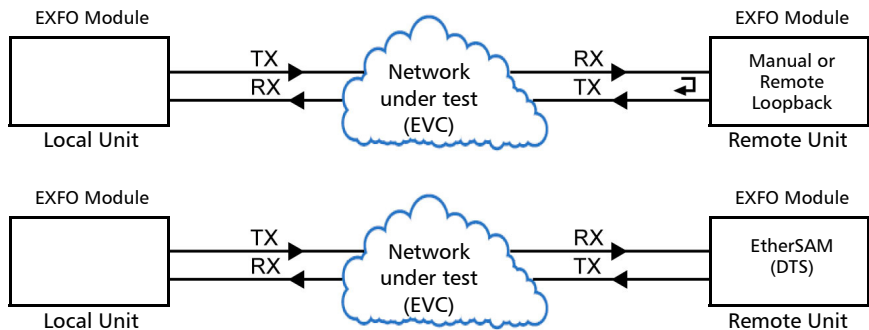

➤ Supported Interfaces/Rates: 10M to 100G.

Test Setup - Test Applications

Multi-Channel OTN

The Multi-Channel OTN test application validates individual channel connectivity with a device under test by allowing concurrent generation and monitoring of all channels of a single or mixed ODUmux test structure.

- Typical Multi-Channel OTN test applications:

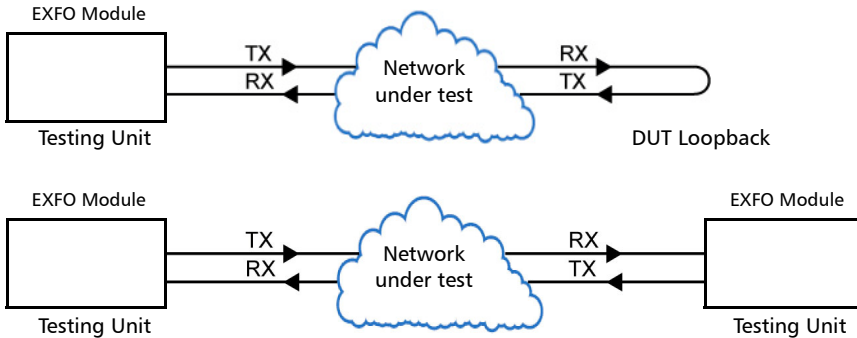

- Path/Mapping

The **Multi-Channel OTN** test application offers the following path/mapping structures depending on the inserted CFP4/QSFP transceivers and enabled options. Mixed mapping is available with the OTN-MIX-MAPPING software option.

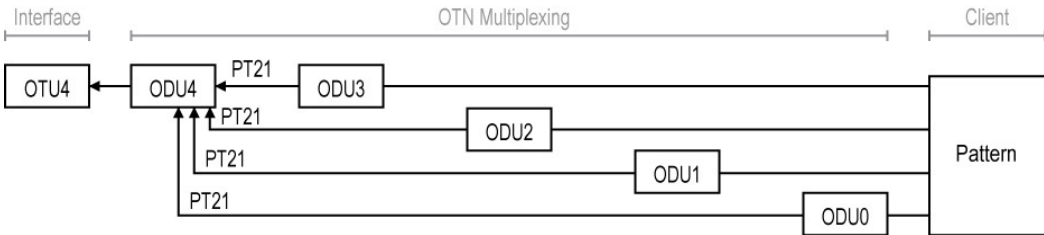

OTN BERT

Allows OTN (framed and unframed), OTN multiplexing, and EoOTN traffic generation with specific test pattern for Bit Error Rate analysis.

- Typical OTN BERT test applications:

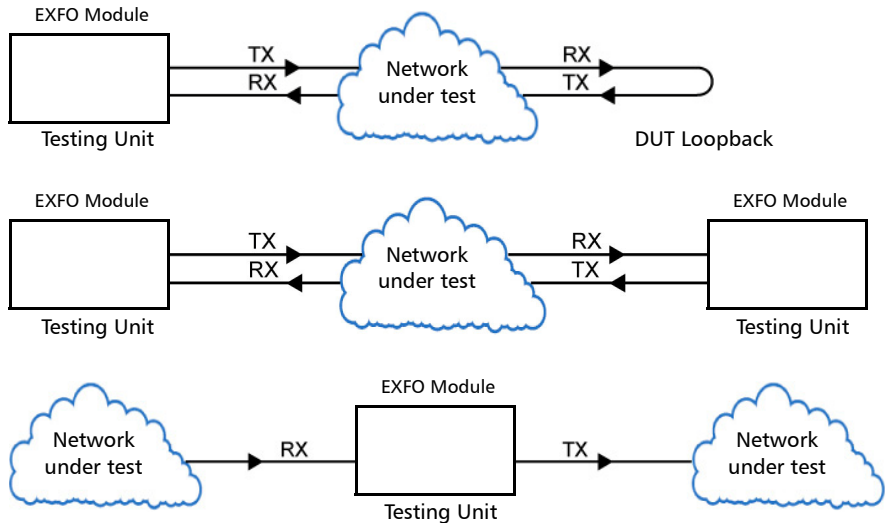

- Path/Mapping

The **OTN BERT** test application offers the following path/mapping structures depending on the inserted transceiver and enabled options.

For 88200NGE (up to OTU4) and 8870/8880 (up to OTU2f)

Test Setup - Test Applications

OTN BERT

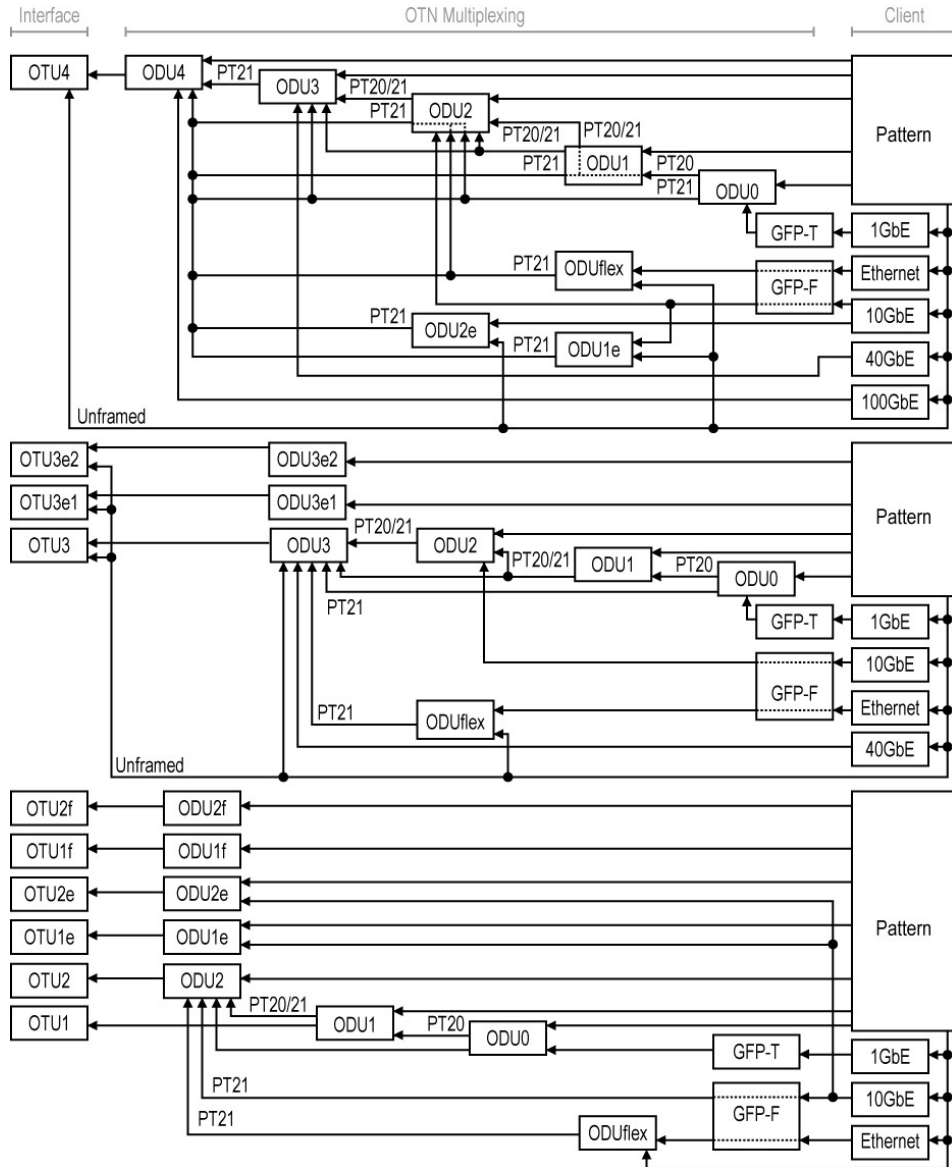

OTN-SONET/SDH BERT

Allows the validation of the SONET/SDH embedded in OTN transport protocol by performing a BERT test to check the traffic or payload stability over a network facility.

- Typical OTN-SONET/SDH BERT test applications:

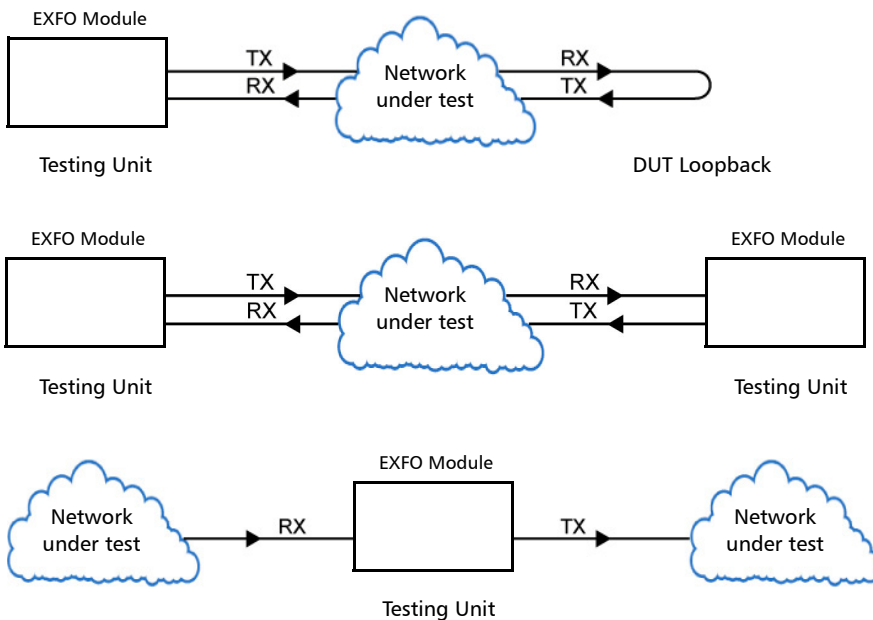

Test Setup - Test Applications

OTN-SONET/SDH BERT

► Path/Mapping

The **OTN-SONET/SDH BERT** test application offers the following path/mapping structures depending on the inserted transceiver and enabled options.

For OTN-SONET BERT: up to OTU4 for 88200NGE and up to OTU2 for 8870/8880.

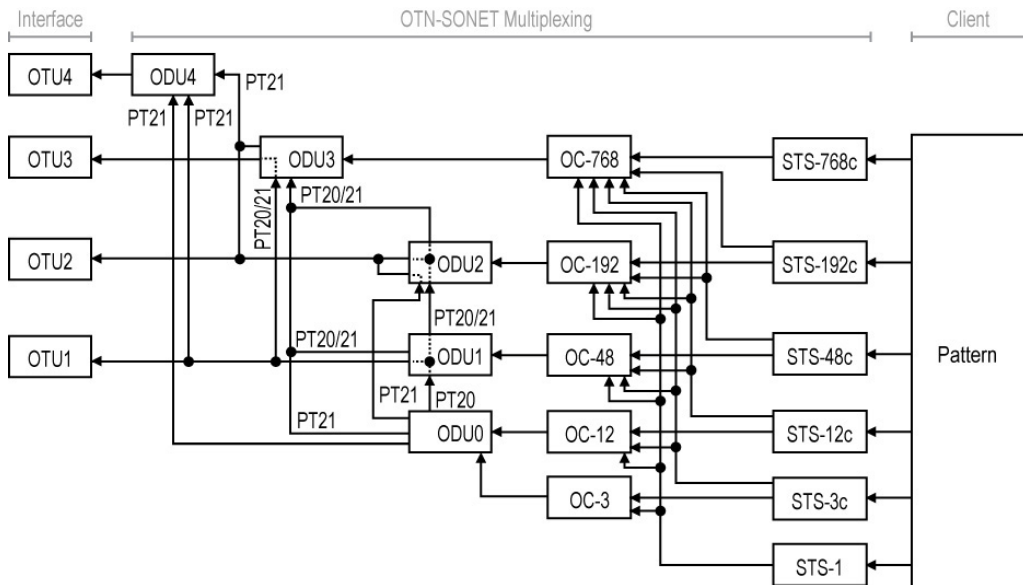

For OTN-SDH BERT: up to OTU4 for 88200NGE and up to OTU2 for 8870/8880.

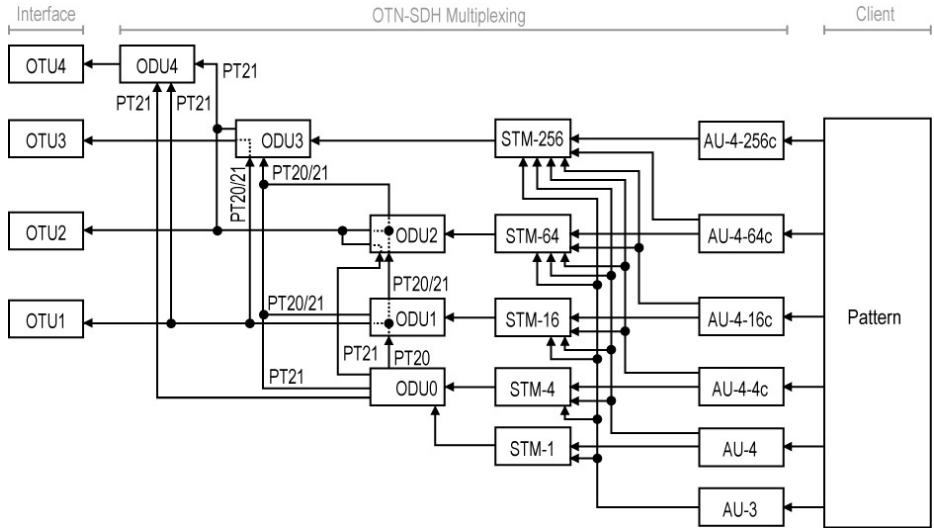

SONET/SDH BERT

Allows the validation of the SONET or SDH transport protocol by performing a BERT test to check the traffic or payload stability over a network facility.

- Typical SONET/SDH BERT test applications:

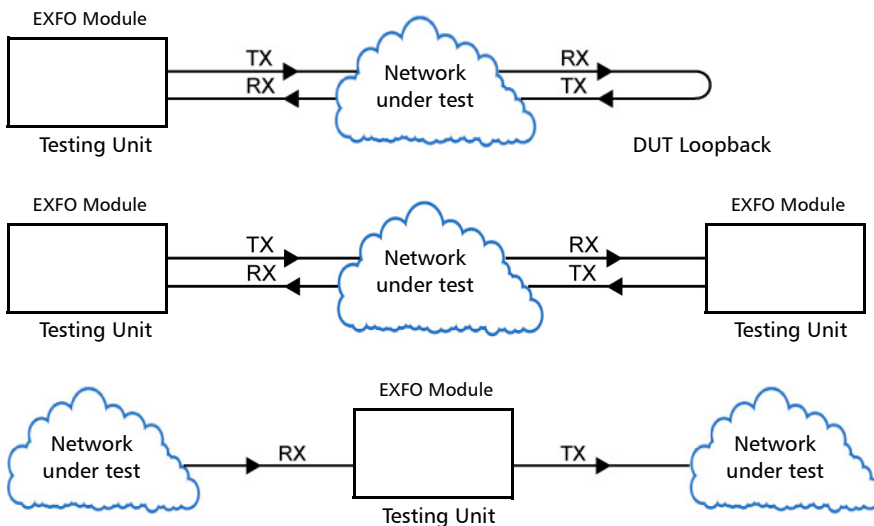

➤ Path/Mapping

The **SONET/SDH BERT** test application offers the following path/mapping structures depending on the inserted transceiver, and enabled options.

For SONET BERT

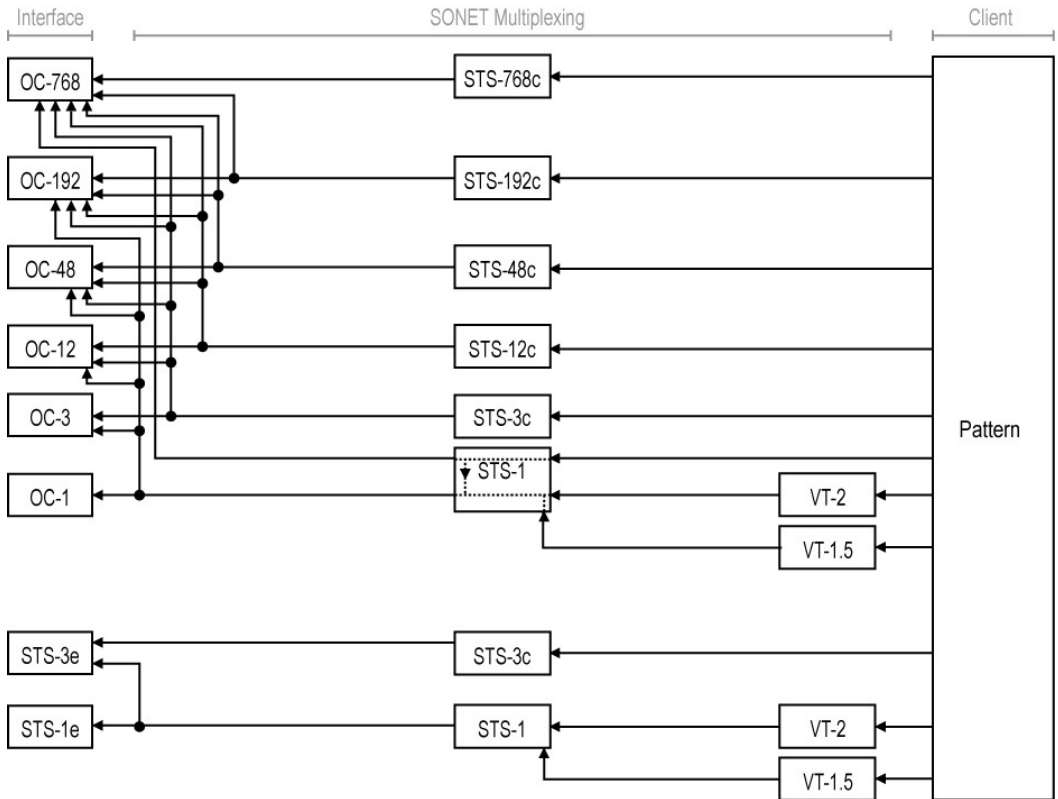

Test Setup - Test Applications

SONET/SDH BERT

For SDH BERT

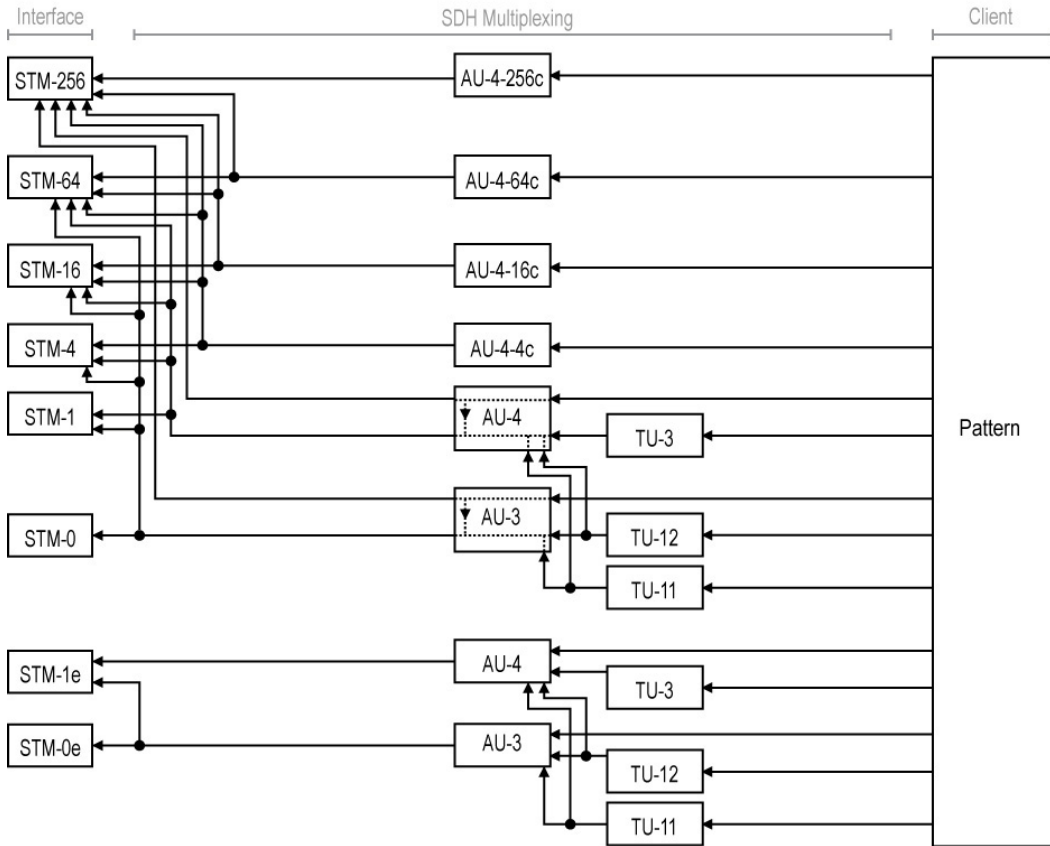

DSn/PDH BERT

Allows validation of the DSn or PDH transport protocol by performing a BERT test to check the traffic or payload stability over a network facility.

- Typical DSn/PDH BERT test applications:

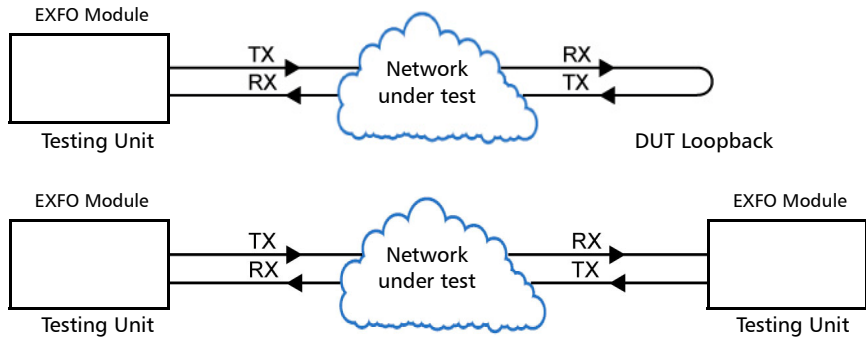

Test Setup - Test Applications

DSn/PDH BERT

► Path/Mapping

The **DSn/PDH BERT** test application offers the following path/mapping structures depending on model and enabled options.

For DSn:

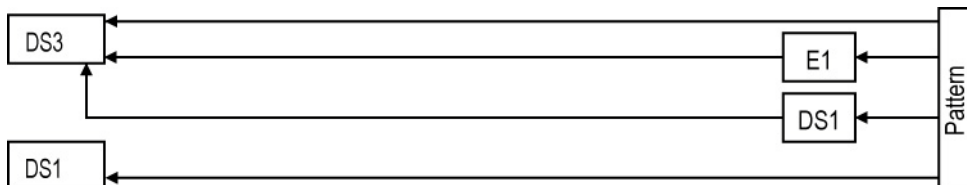

Note: It is possible to enable DS0/E0 from Signal - Signal Configuration (DSn/PDH) on page 294.

For PDH:

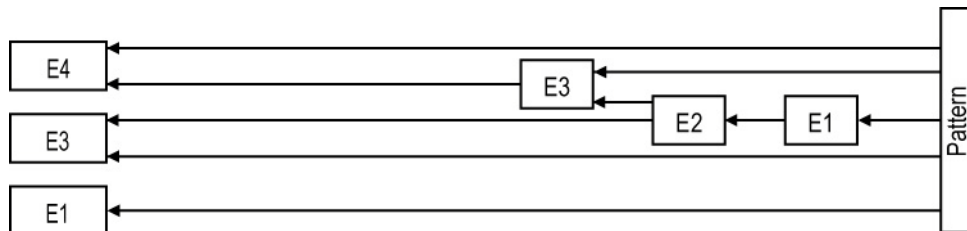

Note: It is possible to enable E0 from Signal - Signal Configuration (DSn/PDH) on page 294.

SONET/SDH - DS_n/PDH BERT

Allows validation of the DS_n or PDH embedded in SONET or SDH transport protocol by performing a BERT test to check the traffic or payload stability over a network facility.

- Typical SONET/SDH - DS_n/PDH BERT test applications:

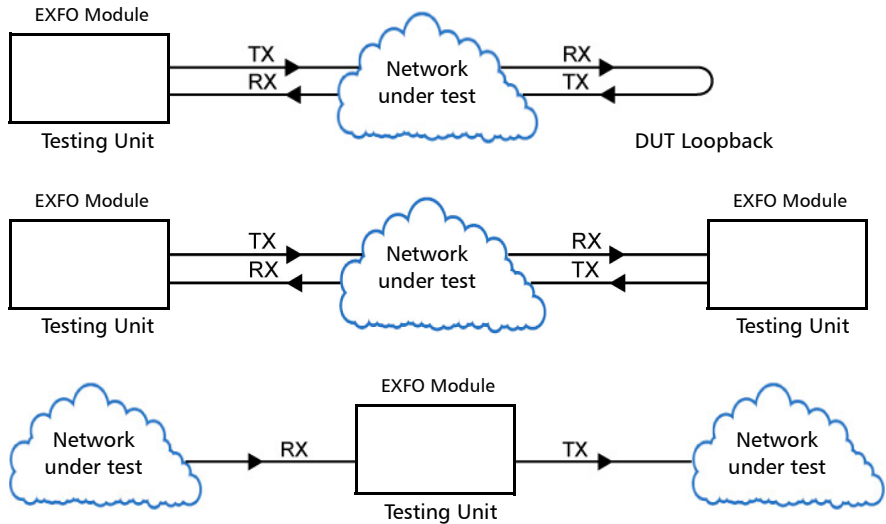

Test Setup - Test Applications

SONET/SDH - DS_n/PDH BERT

➤ Path/Mapping

The **SONET/SDH - DS_n/PDH BERT** test application offers the following path/mapping structures depending on the model and enabled options.

For SONET:

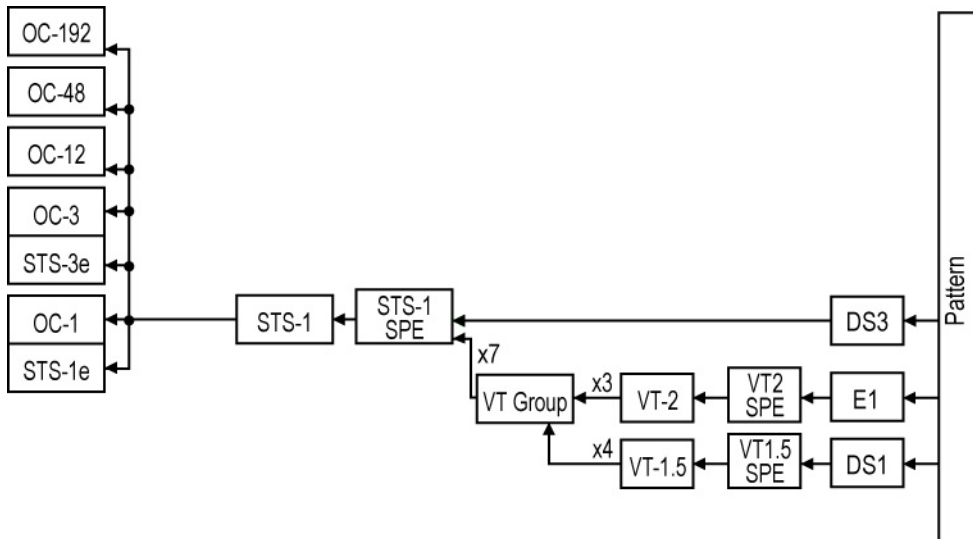

For SDH:

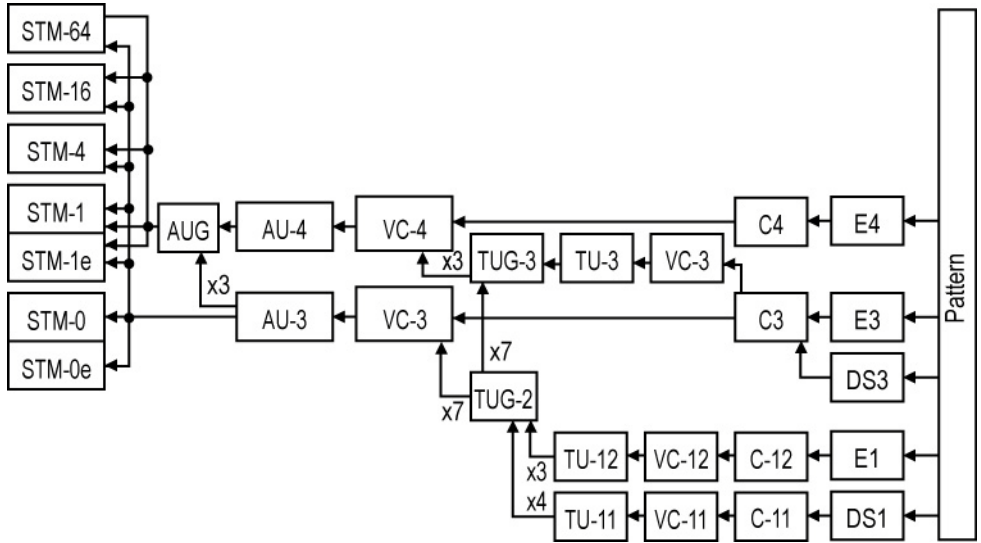

Test Setup - Test Applications

NI/CSU Emulation

NI/CSU Emulation

Allows DS1 testing in NI/CSU (Network Interface/Customer Service Unit) emulation mode.

Typical NI/CSU Emulation test applications:

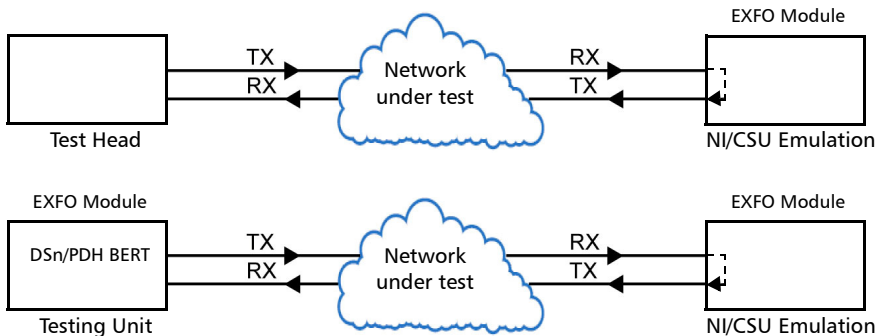

EtherSAM (Y.1564)

EtherSAM can simulate all types of services that will run on the network and simultaneously qualify all key SLA parameters for each of these services. Moreover, it validates the QoS mechanisms provisioned in the network to prioritize the different service types, resulting in more accurate validation and much faster deployment and troubleshooting.

The **EtherSAM (Y.1564)** test, in single port configuration, has to be executed in conjunction with a remote module. The remote module can be either in loopback configuration for unidirectional testing or in **EtherSAM Dual Test Set** mode for bidirectional testing.

The **Dual Test Set** test allows bi-directional testing between two compatible modules providing independent results for each test direction. The results from local-to-remote and remote-to-local are available on the local testing unit.

The **Dual Port** topology allows simultaneous and bidirectional traffic generation and analysis at 100 percent wire-speed at any packet size.

Test Setup - Test Applications

EtherSAM (Y.1564)

- Typical EtherSAM (Y.1564) test applications:

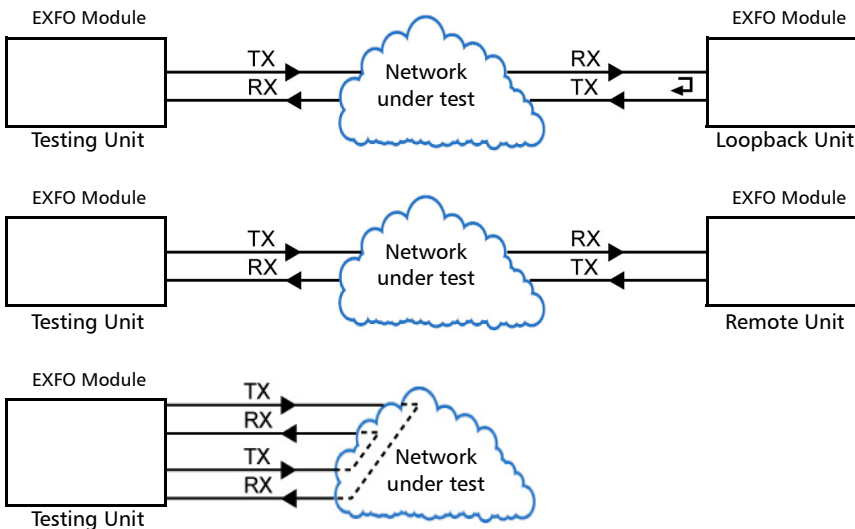

- Supported Interfaces/Rates: 10M to 100G. Dual Port topology is only available for rates up to 10G WAN.

RFC 2544

RFC 2544 allows Ethernet Throughput, Back-to-Back, Frame Loss, and Latency performance testing in accordance with RFC 2544 specifications.

The **RFC 2544** test, in single port configuration, has to be executed in conjunction with a remote module. The remote module can be either in loopback configuration for unidirectional testing or in RFC 2544 **Dual Test Set** mode for bidirectional testing.

The **Dual Test Set** test allows bi-directional testing between two compatible modules providing independent results for each test direction. The results from local-to-remote and remote-to-local are available on the local testing unit.

The **Dual Port** topology allows simultaneous and bidirectional traffic generation and analysis at 100 percent wire-speed at any packet size.

Test Setup - Test Applications

RFC 2544

- Typical RFC 2544 test applications:

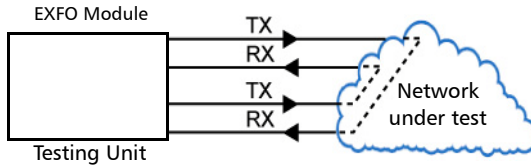
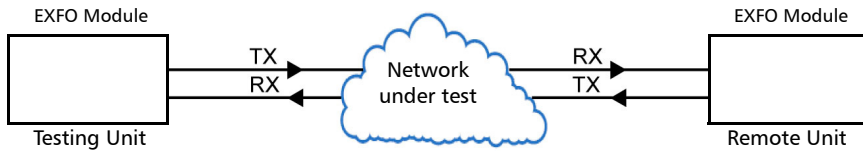
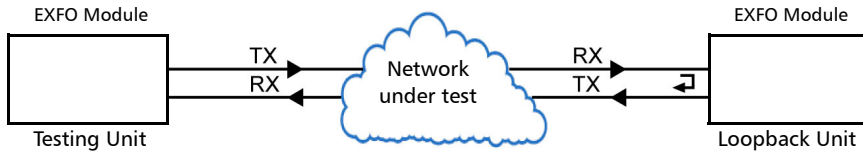

- Supported Interfaces/Rates: 10M to 100G. Dual Port topology is only available for rates up to 10G WAN.

RFC 6349

RFC 6349 is used to confirm that the Ethernet service is able to properly carry TCP traffic.

The **RFC 6349** test has to be executed in conjunction with a remote compatible module in RFC 6349 **Dual Test Set** or **EXFO|Worx Interop** operation mode allowing bidirectional testing. The test provides independent results for each test direction. The results from local-to-remote and remote-to-local are available on the local testing unit.

- Typical RFC 6349 test application:

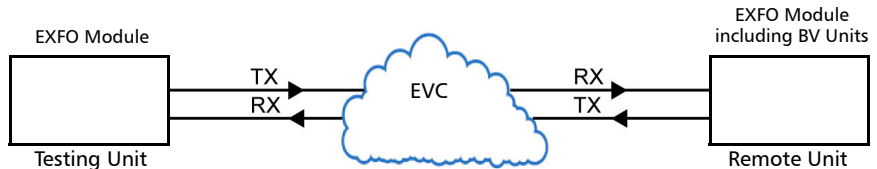

- Supported Interfaces/Rates: 10M to 10G LAN, 40G and 100G.

EtherBERT

Allows Ethernet Layer 1 up to Layer 4 and Unframed Layer 1 traffic generation with specific test pattern for Bit Error Rate analysis.

► Typical EtherBERT test applications:

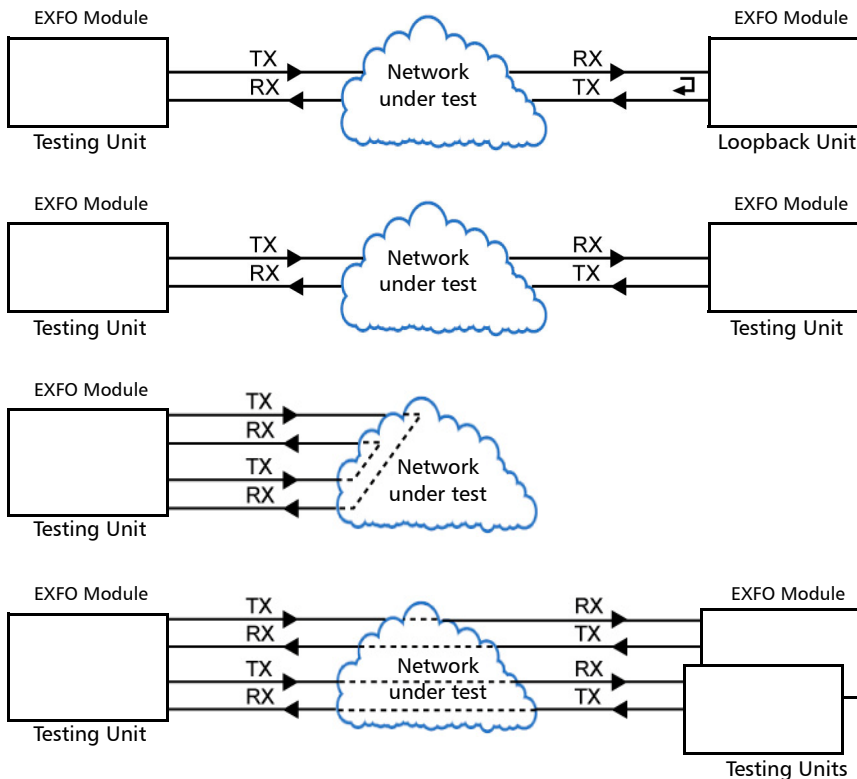

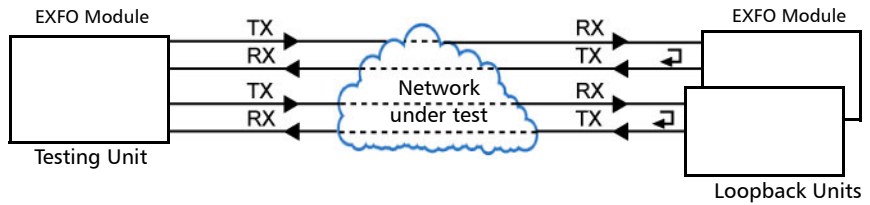

- Supported Interfaces/Rates: 10M to 400G. **Dual Port** topology is available for either rates up to 10G WAN or for rates 40/100G.

Test Setup - Test Applications

Traffic Gen & Mon

Traffic Gen & Mon

Allows Ethernet traffic generation and analysis of up to 16 streams.

► Typical Traffic Gen & Mon test applications:

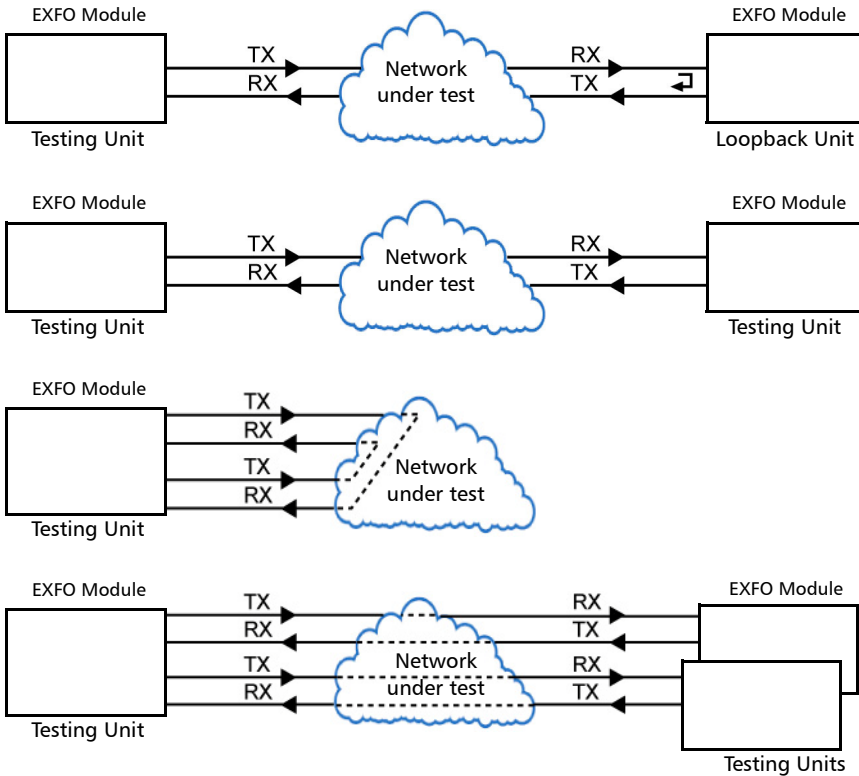

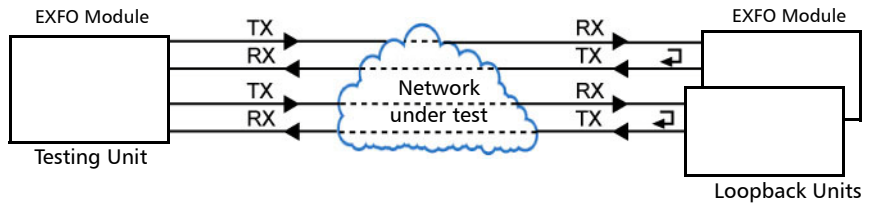

- Supported Interfaces/Rates: 10M to 100G. Dual Port topology is only available for rates up to 10G WAN.

Smart Loopback

Allows transmitting back the received Ethernet stream of data while interchanging the source and destination MAC addresses, IP addresses, and/or UDP/TCP ports. However in **Transparent (Pseudo-Physical)** mode the Smart Loopback operates as a physical loopback by transmitting all received frames unaltered and without discrimination.

The Smart Loopback test can be created locally (refer to *Ethernet Test Applications* on page 87) or remotely using an EXFO unit (refer to *Discover Remote Button* on page 636) or a Third-Party device (see *Third-Party Remote Loopback* on page 69).

- Typical Smart Loopback test application:

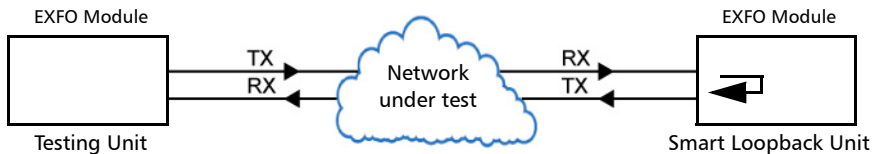

- Supported Interfaces/Rates: 10M to 100G.

Third-Party Remote Loopback

The Third-party Remote Loopback feature provides the capability to be discovered and react to loop-up and loop-down commands from a third party device. This feature is used for unidirectional testing, where the test stream is transmitted from the third party device to a remote EXFO device. The looped back test stream is received and analyzed by the third-party device.

The third-party loopback supports three level of messages:

- Layer 2: Only MAC addresses are swapped.
- Layer 3: MAC and IP addresses are swapped.
- Layer 4: MAC and IP addresses are swapped along with the UDP port.

To emulate a third-party remote device, the loopback mode is set in the function of the layer of loop messages received. The loop messages are:

- Layer 2: Ethernet
- Layer 3: IP
- Layer 4: UDP/TCP

On receipt of the third-party loop-up command as per requested layer, the loopback mode is set and initiated on the module.

Test Setup - Test Applications

Through Mode

Through Mode

The Through Mode test application allows traffic to pass through the module using two electrical or optical ports for in-service troubleshooting of live traffic between the carrier/service provider network and the customer's network.

- Typical Through Mode test application:

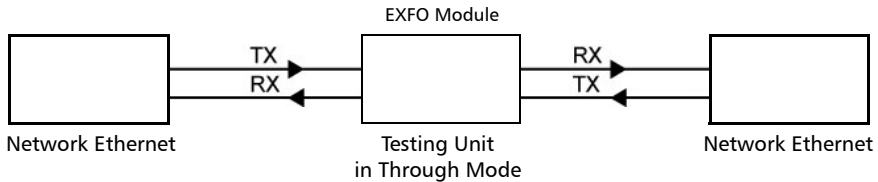

- Supported Interfaces/Rates: 10M to 10GE LAN, and 100GE; 10/100/1000M electrical is supported when using an active copper SFP and the RJ45 port.

TCP Throughput

The objective of this test is to find the TCP throughput based on the successfully transported bytes over the test time. Two units running a TCP Throughput test are required. One unit will act as the source (Local) and the other one as the destination (Remote).

The local unit starts sending TCP segments using the Initial Window Size defined. The window size is adjusted following the TCP algorithm. The window size is incremented until the Maximum Window Size or congestion is reached. However, the window size will be reduced when congestion occurs, then incremented again as described above when the congestion is cleared. TCP Throughput and windows size statistics will be gathered throughout the test.

- Typical TCP Throughput test application:

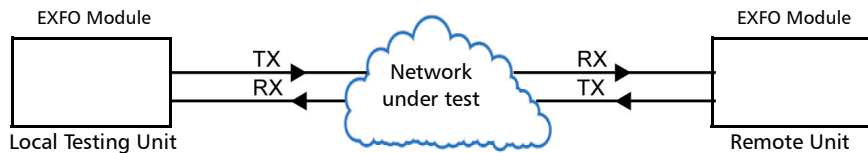

- Supported Interfaces/Rates: 10M to 1G.

Carrier Ethernet OAM

The Carrier Ethernet OAM test application supports the following tests: **Ethernet OAM (S-OAM)**, **MPLS-TP OAM**, and **Link OAM**.

Ethernet OAM and MPLS TP OAM

The Ethernet Service OAM tests are divided into two main categories:

- Performance Monitoring measures parameters such as frame delay, frame loss, and synthetic loss (Y.1731/MEF).
 - Connectivity Fault Management provides the capability for detecting, verifying, and isolating connectivity failure (Y.1731/802.1ag/MEF).
- Typical Ethernet OAM and MPLS TP OAM test applications:

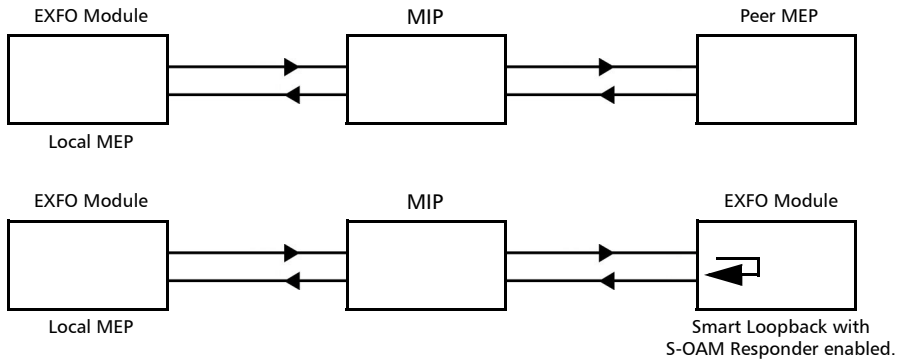

- Supported Interfaces/Rates: 10M to 10G LAN/WAN.

Link OAM

The Link OAM test validates the Link OAM protocol capabilities and the Ethernet link connection of a remote equipment.

- Typical Link OAM test application:

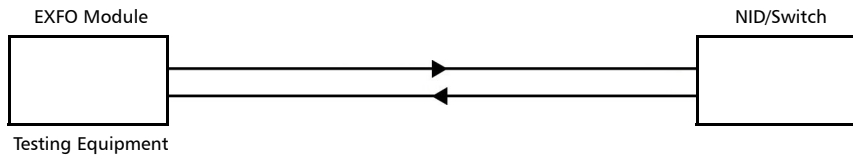

- Supported Interfaces/Rates: 10M to 10G LAN/WAN.

Test Setup - Test Applications

Cable Test

Cable Test

The cable test application is used to diagnose un-shielded twisted pairs (UTP) cables (up to Category 6e/Class E).

Cable test can be performed everywhere in the network where an electrical 10/100/1000 Mbit/s Ethernet interface is available for testing. Only the pairs used by the Ethernet signal will be tested. For 10 Base-T, and 100 Base-TX, pair 2 and 3 will be tested; for 1000 Base-T, all pairs will be tested. However, if the Ethernet signal is unknown, all four pairs will be tested.

Even if a link up is not required when testing with a far end equipment, it is preferable to have the far end equipment powered up to maximize the cable test results.

Supported Ethernet cable categories are: Category 3/Class C, Category 4, Category 5, Category 5e/Class D, and Category 6e/Class E.

Note: *Cable test result is reliable for cable length of 10 meters to 120 meters (32.81 feet to 393.7 feet).*

- Typical Cable Test applications:

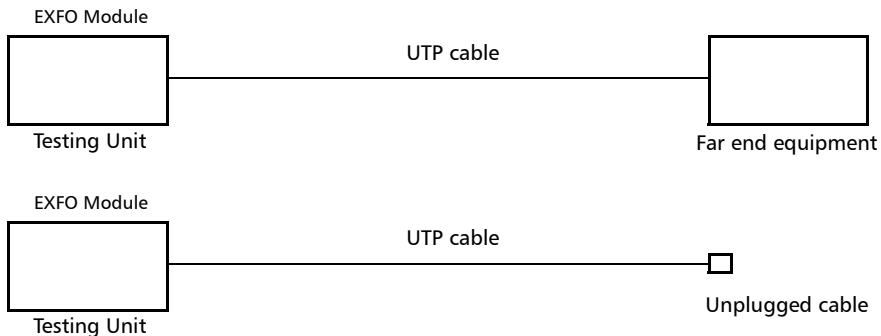

- Supported Interfaces/Rates: 10M to 1000M Electrical.

1588 PTP

The 1588 PTP (Precision Time Protocol) test application handles the 1588 PTP communication with the Grand Master (GM) clock, collects statistics related to packets, and monitors the clock Quality Level.

- Typical 1588 PTP test application:

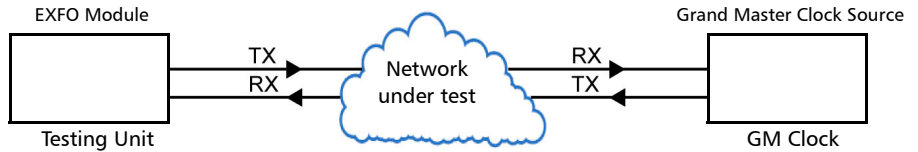

- Supported Interfaces/Rates: 10M to 10G LAN.

SyncE

The Synchronous Ethernet (SyncE) test application provides elementary test primitives to interactively validate the clock management functions of a SyncE capable network equipment.

- Typical SyncE test applications:

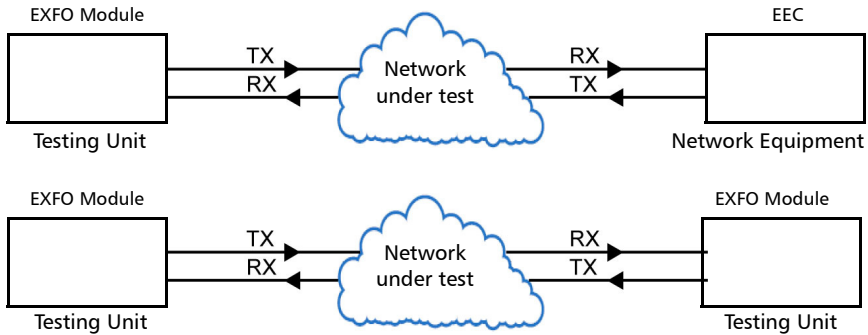

- Supported Interfaces/Rates: 100M to 10G LAN.

Wander

The Wander application provides data acquisition and processing capabilities to quantify and validate the Time Error / Time Interval Error of a synchronization equipment.

Time Error is defined as the difference between the time reported by a clock signal under test and the time reported by a reference clock.

➤ Typical Wander test applications:

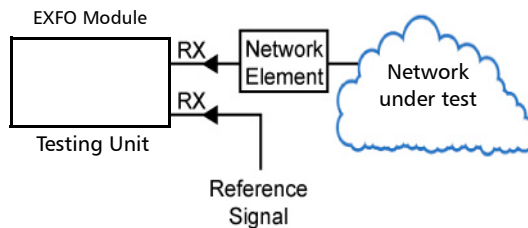

➤ Supported Interfaces/Rates: 100/1000M Electrical, 10GE LAN, 1GE Optical, 100M Optical, DS1, E1, 2 MHz, 10 MHz, and 1PPS.

Note: Only one instance of the Wander application is allowed on a platform due to high processing activity related to MTIE calculation.

Note: The Wander test automatically stops when one of the following alarms occur: LOS, OOF (DS1), LOF (E1), AIS (DS1/E1), or REF-FAULT.

Test Setup - Test Applications

FC BERT

FC BERT

The FC BERT (Fibre Channel BERT) application provides full wire-speed traffic generation at the FC-2 layer allowing BER testing for link integrity measurements, latency, buffer-to-buffer credit measurements for optimization as well as login capabilities.

- Typical Fibre Channel BERT test applications:

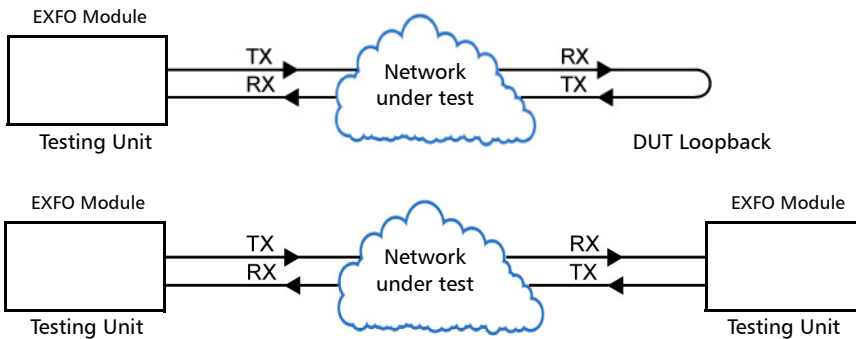

- Supported Interfaces/Rates: 1X, 2X, 4X, 8X, 10X, 16X.

CPRI/OBSAI BERT

The CPRI/OBSAI BERT test application offers the capability to test the fronthaul and dark fiber for Unframed rates and Framed L2 protocol, round trip delay, and Service Disruption Time measurements.

The Common Public Radio Interface (CPRI) is an industry cooperation aimed at defining a publicly available specification for the key internal interface of radio base stations between the Radio Equipment Control (REC) and the Radio Equipment (RE). In the industry the CPRI REC and RE are mainly known as Base Station (BTS) and Remote Radio Head (RRH) respectively.

The Open Base Station Architecture Initiative (OBSAI) separates a traditional radio base station configuration into a Base Transceiver Station (BTS) and a Remote Radio Head (RRH). The BTS processes the digital baseband radio information and performs the control of the RRH. The RRH converts the digital radio information into radio frequency signals transported over the air interface (antenna).

Test Setup - Test Applications

CPRI/OBSAI BERT

➤ Typical CPRI/OBSAI BERT test applications:

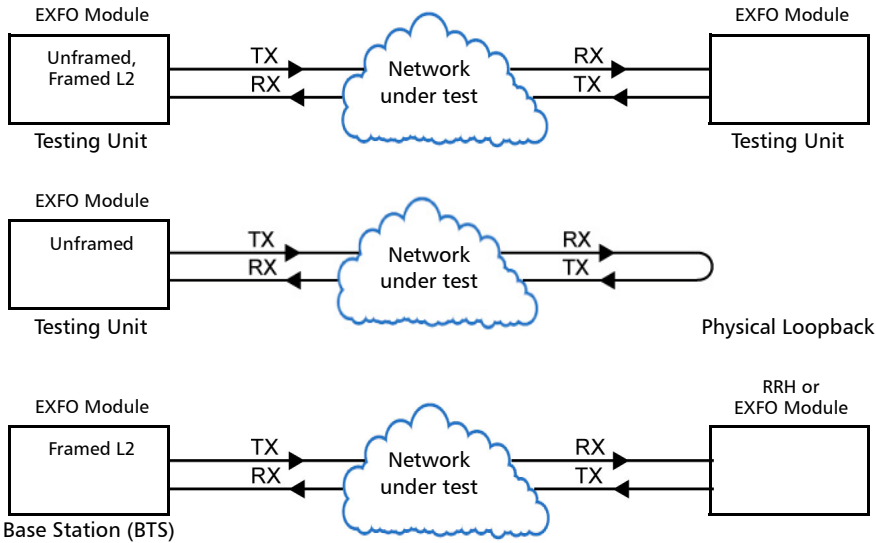

Note: A RRH is typically not capable to perform a loopback of the traffic so BERT test monitoring is not applicable. The BERT test is more common when testing between two test units.

Additional CRPI BERT test application:

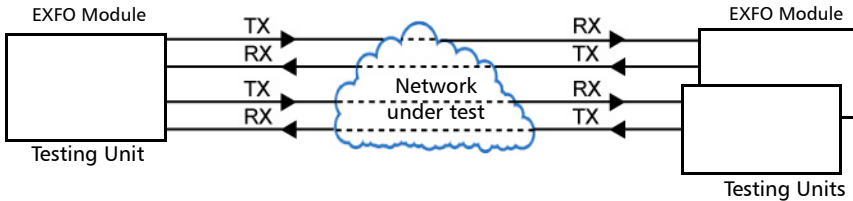

- Supported Interfaces/Rates:
 CPRI: 1.2, 2.4, 3.1, 4.9, 6.1, and 9.8 Gbit/s
 OBSAI: 1.5, 3.1, and 6.1 Gbit/s.

7 Selecting and Starting a Test

A test can be created either by selecting the test from the Test Applications tab or by loading a previously saved configuration (refer to *Save/Load Button* on page 653 for more information).

Intelligent Apps

iOptics

To select, configure, and start iOptics:

1. From the test menu, tap **Setup**.
2. From the **Test Applications** tab, under **Intelligent Apps**, tap the **iOptics** icon.
3. From the **Test Configurator** tab select the interface/port and its rate.

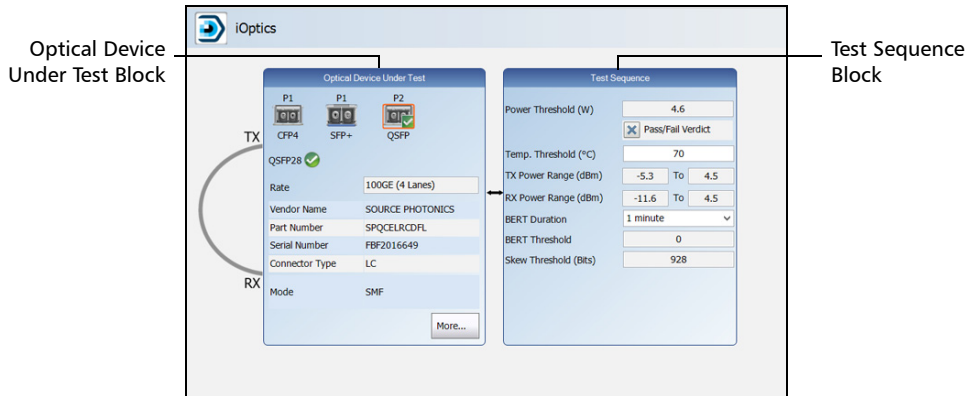

- 3a. From the **Optical Device Under Test** block, tap the desired port icon.
- 3b. Once the transceiver is correctly detected , select its rate.
- 3c. From the **Test Sequence** block, select the test parameters and thresholds (refer to *Test Sequence (iOptics)* on page 329).

Note: The iOptics test application uses **Internal** timing for clock synchronization.

Selecting and Starting a Test

Intelligent Apps

4. Ensure the laser is ON and tap the **Start** button from the right navigation bar to start the test (refer to *Start/Stop | TX Button* on page 657). The **Summary** result page will be automatically displayed when the test is started. For additional results refer to *Test Results* on page 341. The test automatically stops when the transceiver is invalid or missing.
5. When the test ends automatically or is manually stopped, the generate report pop-up is displayed by default. If required, tap **Yes** to generate a report of the test results and statistics (refer to *Report Button* on page 647 for more information).

iSAM

To select, configure, and start iSAM:

1. From the test menu, tap **Setup**.
2. From the **Test Applications** tab, under **Intelligent Apps**, tap the **iSAM** icon.
3. From the **Test Configurator** tab configure the interface structure and its parameters.

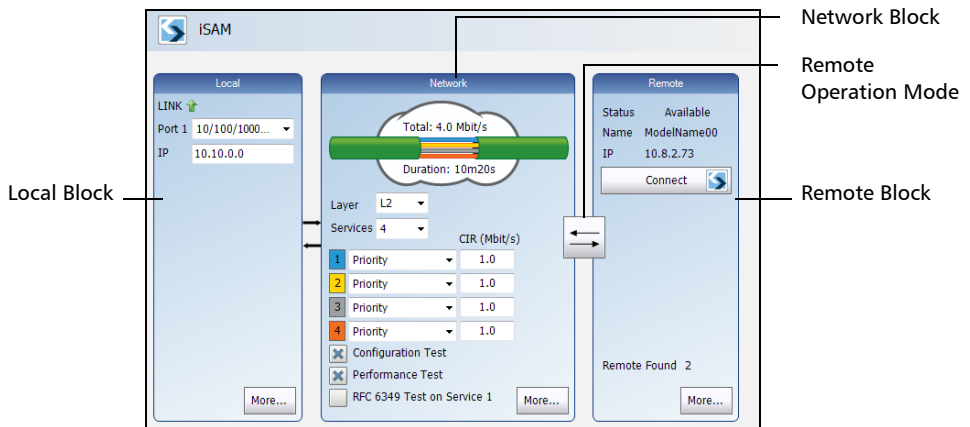



- 3a. From the **Local** block, either select the basic port parameters or click on **More** for all settings (refer to *Local Details (iSAM)* on page 200). Ensure that the link is up and the power level for optical interface (when supported) is adequate in the status bar before proceeding to the next step (refer to *Status Bar* on page 28).

For CFP/QSFP interface rates, check for the optical validation check mark  indicating that the transceiver matches the configured interface/rate (refer to *Physical Interface Port - Test Configurator Overview* on page 100).

Selecting and Starting a Test

- 3b.** From the **Network** block, either select the basic test parameters or click on **More** for all settings (refer to *Network Details (iSAM)* on page 226). The total bandwidth and the estimated test duration are displayed.
- 3c.** Select the remote operation mode; DTS is automatically selected when the **RFC 6349 Test** is enabled:

	DTS (Dual Test Set) The remote device is automatically set in EtherSAM when the connection/overtake is successfully established.
	Remote Loopback The remote device is automatically set in Smart Loopback when the connection/overtake is successfully established.
	Manual Loopback The remote device is a physical loopback or has to be manually set in loopback.

- 3d.** From the **Remote** block, either select the basic remote parameters or click on **More** for all settings (refer to *Remote Details (iSAM)* on page 248).

Note: The *iSAM* test application uses **Internal** timing for clock synchronization.

- 4.** Tap the **Start** button from the right navigation bar to start the test (refer to *Start/Stop | TX Button* on page 657). If the connection with the remote module is not established with either **DTS** or **Remote Loopback** mode, the automatic remote connection process is performed before starting the test. The **Summary** result page will be automatically displayed when the test is started from any **Setup** configuration page. For additional results refer to *Test Results* on page 341.
- 5.** When the test ends automatically or is manually stopped, the generate report pop-up is displayed by default. If required, tap **Yes** to generate a report of the test results and statistics (refer to *Report Button* on page 647 for more information).

Transport Test Applications

To select, configure, and start a Transport test:

1. From the test menu, tap **Setup**.
2. From the **Test Applications** tab, under **Transport**, tap a test icon.
3. From the **Test Configurator** tab configure the signal structure and its parameters.

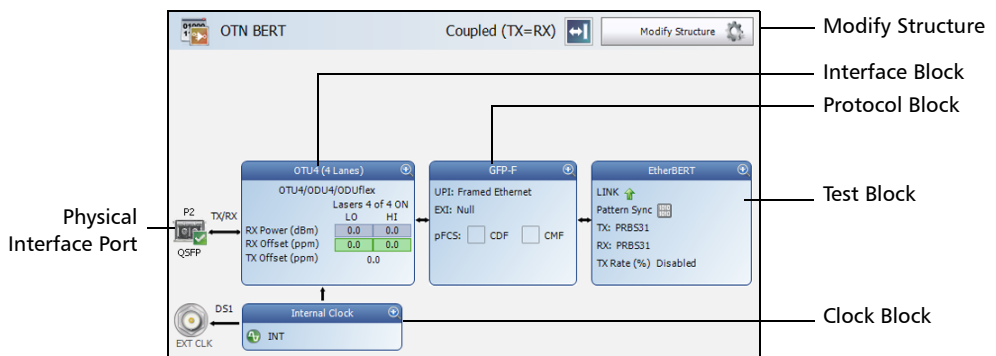

- 3a.** Tap the **Modify Structure** button to set the basic structure of the test such as the interface/rate, connector, etc. (refer to *Modify Structure Button* on page 108).
- 3b.** For CFP/QSFP interface, check for the optical validation check mark indicating that the transceiver matches the configured interface/rate (refer to *Physical Interface Port - Test Configurator Overview* on page 100).
- 3c.** Tap the interface block to configure the signal parameters (refer to page 95).
- 3d.** For an embedded signal, tap the protocol block to configure the signal (refer to page 95).

Selecting and Starting a Test

Transport Test Applications

- 3e.** Tap the test block to configure the specific test settings (refer to page 95). Not available with **NI/CSU Emulation** test application.
- 3f.** Tap the clock block to configure the clock synchronization (refer to *Clock* on page 148).
- 4.** Tap the **Timer** tab to automatically start and/or stop the test at a given time or for a specific duration (refer to *Timer* on page 330).
- 5.** For additional test configurations refer to *Test Functions* on page 539.
- 6.** Tap the **Start** button from the right navigation bar to start the test. (refer to *Start/Stop | TX Button* on page 657). The **Summary** result page will be automatically displayed when the test is started from any **Setup** configuration page. For additional results, refer to *Test Results* on page 341.
- 7.** Tap the **Stop** button to stop the test. By default the generate report pop-up is displayed. If required, tap **Yes** to generate a report of the test results and statistics (refer to *Report Button* on page 647).

Ethernet Test Applications

To select, configure, and start an Ethernet test:

1. From the test menu, tap **Setup**.
2. From the **Test Applications** tab, under **Ethernet**, tap a test icon.
3. From the **Test Configurator** tab configure the interface structure and its parameters.

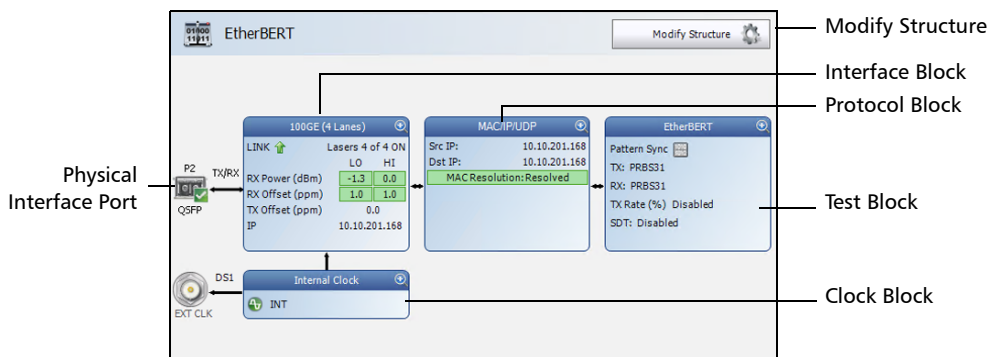

- 3a. Tap the **Modify Structure** button to set the basic structure of the test such as the interface/rate, connector, etc. (refer to *Modify Structure Button* on page 108).
- 3b. For CFP4/CFP8/QSFP interface, check for the optical validation check mark indicating that the transceiver matches the configured interface/rate (refer to *Physical Interface Port - Test Configurator Overview* on page 100).
- 3c. Tap the interface block to configure the interface parameters (refer to page 95). For **Dual Port** topology, there is an interface block for each port. Ensure that the link is up and the power level (when supported) is present in the status bar before proceeding to the next step (refer to *Status Bar* on page 28).

Selecting and Starting a Test

- 3d.** Tap the protocol block¹ to configure the frame structure and its parameters (refer to page 97). For RFC 2544, EtherBERT, and Traffic Gen & Mon in Dual Port topology, there is a protocol block for each port.
- 3e.** Tap the test block² to configure the specific test settings (refer to page 97).
- 3f.** Tap the clock block³ to configure the clock synchronization (refer to *Clock* on page 148).
- 4.** Tap the **Timer** tab to automatically start and/or stop the test at a given time or for a specific duration (refer to *Timer* on page 330).
- 5.** For additional test configurations refer to *Test Functions* on page 539.
- 6.** Tap the **Start** button from the right navigation bar to start the test (refer to *Start/Stop | TX Button* on page 657). The **Summary** result page will be automatically displayed when the test is started from any **Setup** configuration page. For additional results refer to *Test Results* on page 341.
- 7.** Depending on the test, when the test ends automatically or is manually stopped, the generate report pop-up is displayed by default. If required, tap **Yes** to generate a report of the test results and statistics (refer to *Report Button* on page 647 for more information).

1. Not available with Smart Loopback, Through Mode, TCP Throughput, Carrier Ethernet OAM, and Cable Test.

2. Not available with Traffic Gen & Mon and Through Mode.

3. Not available with **Dual Port** topology, 25GE test, 400GE test, and when using an active copper SFP. However the clock is either set to **Internal** or **Auto** (1GE electrical).

Sync Test Applications

To select, configure, and start a Sync test:

1. From the test menu, tap **Setup**.
2. From the **Test Applications** tab, under **Sync**, tap a test icon.
3. From the **Test Configurator** tab configure the interface structure and its parameters.

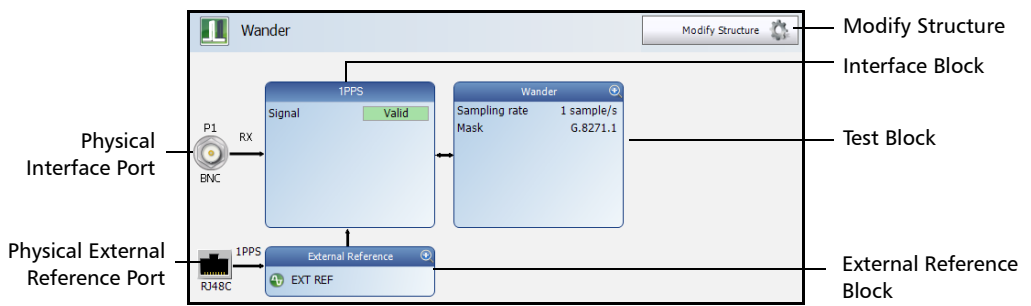

- 3a. Tap the **Modify Structure** button to set the basic structure of the test such as the interface/rate, connector, etc. (refer to *Modify Structure Button* on page 108).
- 3b. Tap the interface block to configure the interface parameters (refer to page 95; no configuration is available with Wander 10 MHz, 2 MHz, and 1PPS rates). Ensure that the link is up and the power level (when supported) is present in the status bar before proceeding to the next step (refer to *Status Bar* on page 28).
- 3c. Tap the test block to configure the specific test settings (refer to page 98).
- 3d. For Wander test application, tap the external reference block to configure the external reference signal (refer to *External Reference* on page 171).

Selecting and Starting a Test

Sync Test Applications

4. Tap the **Timer** tab to automatically start and/or stop the test at a given time or for a specific duration (refer to *Timer* on page 330). Not supported with Wander test application.
5. For additional test configurations refer to *Test Functions* on page 539.
6. Tap the **Start** button from the right navigation bar to start the test (refer to *Start/Stop | TX Button* on page 657). The **Summary** result page will be automatically displayed when the test is started from any **Setup** configuration page. For additional results refer to *Test Results* on page 341.
7. Depending on the test, when the test ends automatically or manually stopped, the generate report pop-up is displayed by default. If required, tap **Yes** to generate a report of the test results and statistics (refer to *Report Button* on page 647 for more information).

Fibre Channel Test Application

To select, configure, and start a Fibre Channel test:

1. From the test menu, tap **Setup**.
2. From the **Test Applications** tab, under **Fibre Channel**, tap the **FC BERT** test icon.
3. From the **Test Configurator** tab configure the interface structure and its parameters.

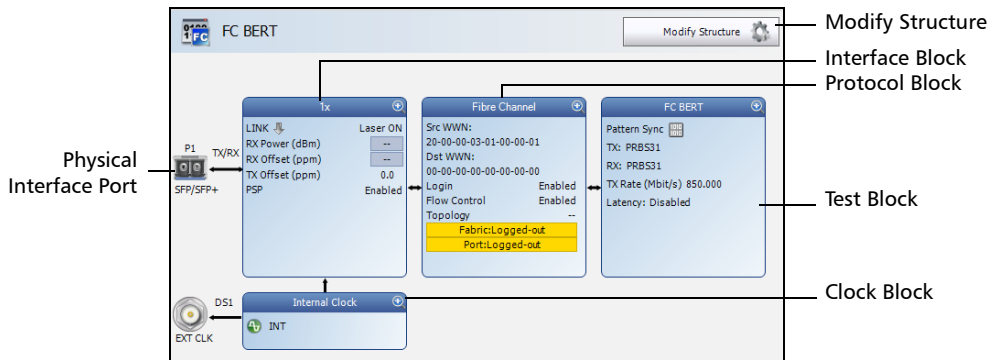

- 3a. Tap the **Modify Structure** button to set the basic structure of the test such as the interface/rate and connector. (refer to *Modify Structure Button* on page 108).
- 3b. Tap the interface block to configure the interface parameters (refer to page 182). Ensure that the link is up and the power level (when supported) is present in the status bar before proceeding to the next step (refer to *Status Bar* on page 28).
- 3c. Tap the protocol block to configure the frame structure and its parameters (refer to page 172).

Selecting and Starting a Test

Fibre Channel Test Application

- 3d.** Tap the test block to configure the specific test settings (refer to page 155).
- 3e.** Tap the clock block to configure the clock synchronization (refer to *Clock* on page 148).
- 4.** Tap the **Timer** tab to automatically start and/or stop the test at a given time or for a specific duration (refer to *Timer* on page 330).
- 5.** Tap the **Start** button from the right navigation bar to start the test (refer to *Start/Stop | TX Button* on page 657). The **Summary** result page will be automatically displayed when the test is started from any **Setup** configuration page. For additional results refer to *Test Results* on page 341.
- 6.** When the test ends automatically or is manually stopped, the generate report pop-up is displayed by default. If required, tap **Yes** to generate a report of the test results and statistics (refer to *Report Button* on page 647 for more information).

Wireless Test Application

To select, configure, and start a Wireless test:

1. From the test menu, tap **Setup**.
2. From the **Test Applications** tab, under **Wireless**, tap the **CPRI/OBSAI BERT** test icon.
3. From the **Test Configurator** tab configure the interface structure and its parameters.

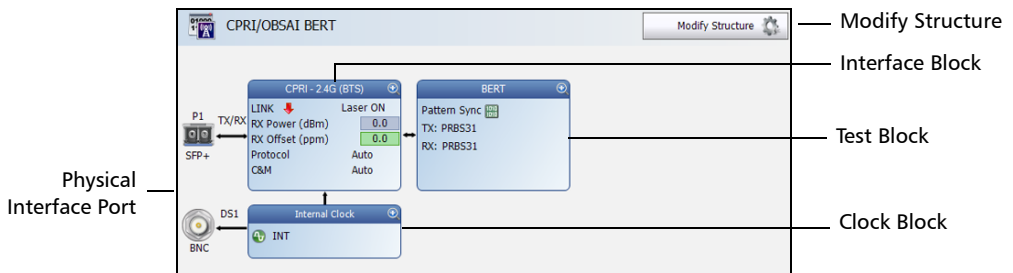

3a. Tap the **Modify Structure** button to set the basic structure of the test such as the interface/rate, connector, etc. (refer to *Modify Structure Button* on page 108).

3b. Tap the interface block to configure the interface parameters (refer to page 182). For **Dual Port** topology, there is an interface block for each port. Ensure that the power level is present in the status bar before proceeding to the next step (refer to *Status Bar* on page 28).

Selecting and Starting a Test

Wireless Test Application

- 3c.** Tap the test block to configure the specific test settings (refer to page 155). For **Dual Port** topology, there is a test block for each port.
- 3d.** For **Framed L2** in **Base Station** emulation mode, tap the clock block¹ to configure the clock synchronization (refer to *Clock* on page 148). The clock is automatically set to **Recovered** for **Remote Radio Head** emulation mode.

Note: For *Unframed*, the clock is set to **Internal**.

- 4.** Refer to *Test Functions* on page 539 for additional test configurations.
- 5.** Tap the **Timer** tab to automatically start and/or stop the test at a given time or for a specific duration (refer to *Timer* on page 330).
- 6.** Tap the **Start** button from the right navigation bar to start the test (refer to *Start/Stop | TX Button* on page 657). The **Summary** result page will be automatically displayed when the test is started from any **Setup** configuration page. For additional results refer to *Test Results* on page 341.
- 7.** When the test ends automatically or is manually stopped, the generate report pop-up is displayed by default. If required, tap **Yes** to generate a report of the test results and statistics (refer to *Report Button* on page 647 for more information).

1. Not available in **Dual Port** topology. However the clock is automatically set to **Internal** for the **Base Station** and **Recovered** for the **Remote Radio Head**.

8 **Test Setup - Test Configurator, Timer, and System**

The **Setup** menu offers the following structure:

- **Test Configurator for Intelligent Apps** test application.

Test Application	Block	Subtab or Pop Up	Page
iOptics	Optical Device Under Test	Optical Device Under Test Details	245
	Test Sequence	-	329
iSAM	Local	Local Details	200
		CFP4/QSFP/SFP+	147
	Network	Network Details	226
	Remote	Remote Details	248

Test Setup - Test Configurator, Timer, and System

➤ **Test Configurator** for **Transport** test applications.

Block	Subtab or Pop Up	Available with							Page
		OTN BERT	Multi-Channel OTN	OTN-SONET/SDH BERT	SONET/SDH BERT	DSn/PDH BERT	SONET/SDH - DSn/PDH BERT	NI/CSU Emulation	
Button	Modify Structure	X	X	X	X	X	X	X	108
	Signal Auto-Detect	-	-	-	-	X	-	X	131
Interface	CFP4/QSFP/SFP/SFP+	X	X	X	X	-	X	-	147
	Frequency ^a	X	X	X	-	-	-	-	175
	FTFL/PT and PT	X	X	X	-	-	-	-	177
	Labels	-	-	-	X	-	X	-	196
	Signal	X	X	X	X	X	X	X	287
	Traces	332	332	332	336	-	336	-	<---
Protocol	GFP-F/GFP-T	X	-	-	-	-	-	-	181
	Labels	-	-	X	-	-	-	-	196
	Signal	-	-	X	-	-	X	-	307
	Traces	-	-	X	-	-	-	-	336
Test	BERT	X	-	X ^b	X ^b	X	X	-	139
	EtherBERT	X ^c	-	-	-	-	-	-	155
	Global (ODU Channels)	-	X	-	-	-	-	-	237
	PT	-	X	-	-	-	-	-	177
	Traces	-	X	-	-	-	-	-	332
	Unframed BERT	X	-	-	-	-	-	-	139
Clock	Clock	X	X	X	X	X	X	X	148

a. Available with parallel interface only.

b. Only framed test is supported.

c. Available with EoOTN client only.

➤ **Test Configurator** for Ethernet test applications.

Block	Subtab or Pop Up	Test Application										Page
		a	b	c	d	e	f	g	h	i	j	
Button	Modify Structure	X	X	X	X	X	X	X	X	X	X	120
Interface	CFP4/CFP8/QSFP/SFP28/SFP/SFP+	X	X	X	X	X	X	X	X	X	-	147
	Frequency	X	-	X	X	X	X	X	-	-	-	175
	Interface	X	X	X	X	X	X	X	X	X	X	182
	Network	X	X	X	X	X	X	X	X	X	X	220
	TA-SFP28	-	-	X	X	X	X	-	-	-	-	326
Protocol	MAC/IP/UDP	X	-	X	X	X	-	-	-	-	-	204
	Services - Global	X	-	-	-	-	-	-	-	-	-	277
	Services - Profile	X	-	-	-	-	-	-	-	-	-	280
	Streams - Global	-	-	-	-	X	-	-	-	-	-	313
	Streams - Profile	-	-	-	-	X	-	-	-	-	-	315
Test	Cable Test	-	-	-	-	-	-	-	-	-	X	145
	EtherBERT	-	-	-	X	-	-	-	-	-	-	155
	EtherSAM - Burst	X	-	-	-	-	-	-	-	-	-	163
	EtherSAM - Global	X	-	-	-	-	-	-	-	-	-	165
	EtherSAM - Ramp	X	-	-	-	-	-	-	-	-	-	169
	Link OAM	-	-	-	-	-	-	-	-	X	-	198
	RFC 2544 - Global	-	-	X	-	-	-	-	-	-	-	252
	RFC 2544 - Subtests	-	-	X	-	-	-	-	-	-	-	255
	RFC 6349	-	X	-	-	-	-	-	-	-	-	264
	S-OAM / MPLS-TP OAM	-	-	-	-	-	-	-	-	X	-	267
	Smart Loopback	-	-	-	-	-	X	-	-	-	-	311
	TCP Throughput	-	-	-	-	-	-	-	X	-	-	327
	Unframed BERT (up to 10GE)	-	-	-	X	-	-	-	-	-	-	155
Unframed BERT (40/100GE)	-	-	-	X	-	-	-	-	-	-	139	
Clock	Clock	X	-	X	X	X	X	-	X	X	-	148

- a. EtherSAM
- b. RFC 6349
- c. RFC 2544
- d. EtherBERT
- e. Traffic Gen & Mon
- f. Smart Loopback
- g. Through Mode
- h. TCP Throughput
- i. Carrier Ethernet OAM
- j. Cable Test

Test Setup - Test Configurator, Timer, and System

- **Test Configurator** for Sync test applications.

Block	Subtab or Pop Up	Test Application			Page
		1588 PTP	SyncE	Wander	
Button	Modify Structure	X	X	X	126
Interface	Interface	X	X	X ^a	182
	Network	X	X	X	220
	SFP/SFP+	X	X	X	147
Test	1588 PTP	X	-	-	132
	SyncE	-	X	-	323
	Wander	-	-	X	338
External Reference	External Reference	-	-	X	171

- a. No configuration available.

- **Test Configurator** for **Fibre Channel** test application.

Block	Subtab or Pop Up	Test Application	Page
		FC BERT	
Button	Modify Structure	X	128
Interface	Interface	X	182
	SFP/SFP+	X	147
Protocol	Fibre Channel	X	172
Test	FC BERT	X	155

- **Test Configurator** for **Wireless** test application.

Block	Subtab or Pop Up	Test Application CPRI/OBSAI BERT	Page
Button	Modify Structure	X	129
Interface	Interface	X	182
	SFP/SFP+	X	147
Test	BERT and Unframed BERT	X	155

- **Timer**, see page 330.
- **System**, see page 325.

Test Configurator Overview

The **Test Configurator** tab displays the interconnected blocks composing the test structure. Each block of the test structure gives an overview of its configuration/status. Availability of each block depends on the selected test application and its structure. Arrows are used to indicate the interconnection between blocks as well as the direction of the clock and data flow. Tap on a block or the **More** button for **Intelligent Apps**, to change the configuration parameters of this block.

From the **Test** menu, tap **Setup**, and the **Test Configurator** tab.

- Intelligent Apps:

iOptics:

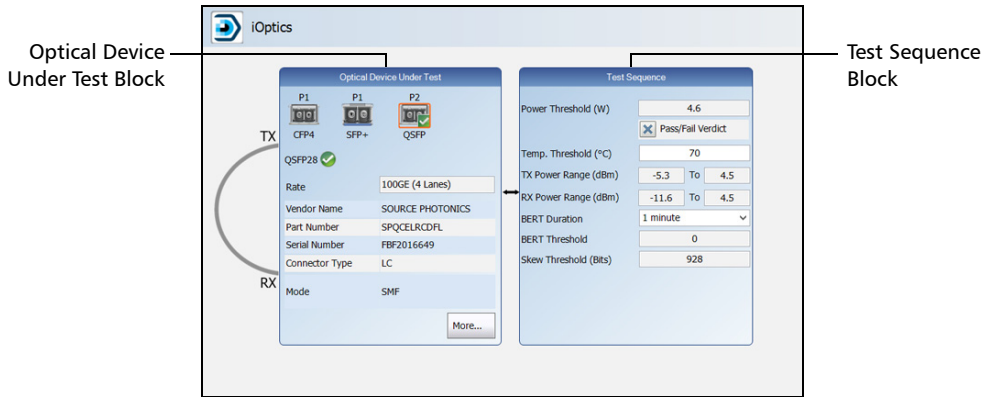

- **Optical Device Under Test** block displays and allows changing the basic interface/port settings. Tap on the **More** button to access more information and settings.
- **Test Sequence** block allows changing the basic test settings.

iSAM:

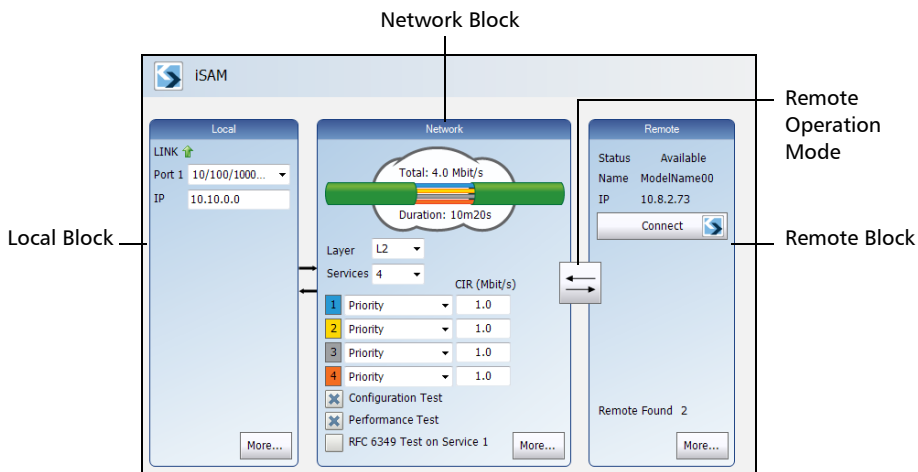

The block arrangement represents the network under test. From any block, either select the basic parameters or click on **More** for all settings.

- **Local** block displays and allows changing the basic interface settings. Tap on the **More** button to access all settings.
- **Network** block displays and allows changing the basic test settings. Tap on the **More** button to access all settings.
- Remote operation mode allows selecting the remote operation mode. Tap on the button to change the remote operation mode.
- **Remote** block displays and allows changing the basic remote settings. Tap on the **More** button to access all settings.

Test Setup - Test Configurator, Timer, and System

Test Configurator Overview

➤ Transport Test Applications:

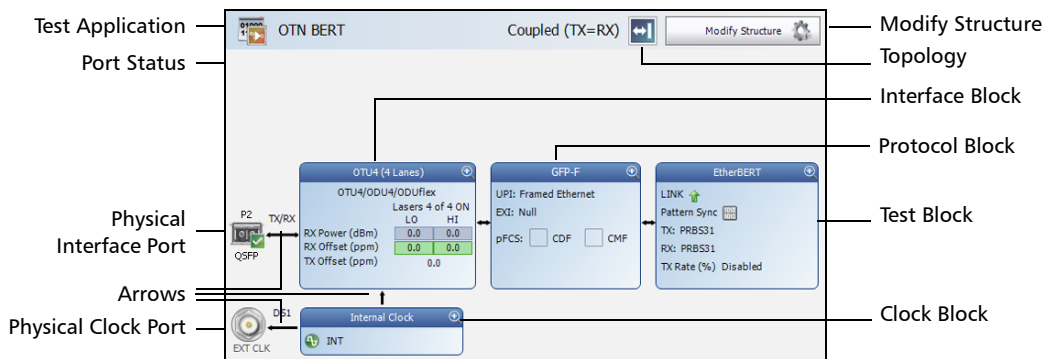

➤ Ethernet Test Applications:

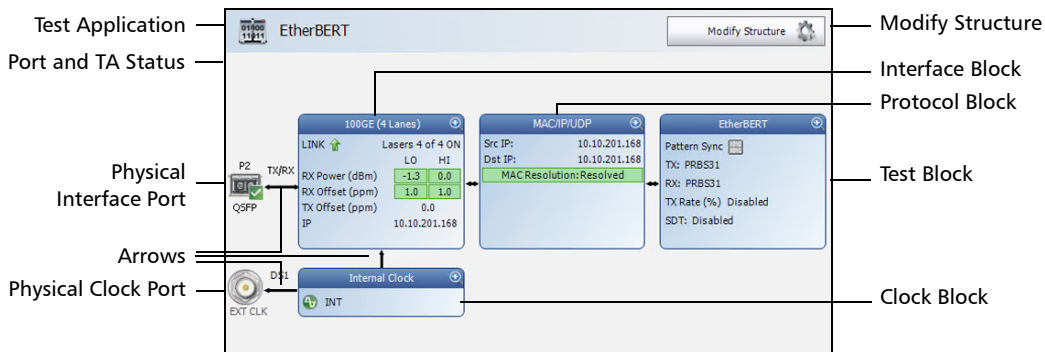

➤ Sync Test Applications:

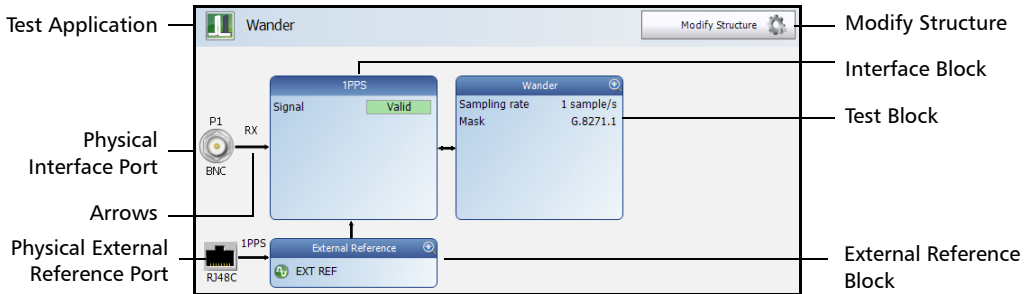

➤ Fibre Channel Test Application:

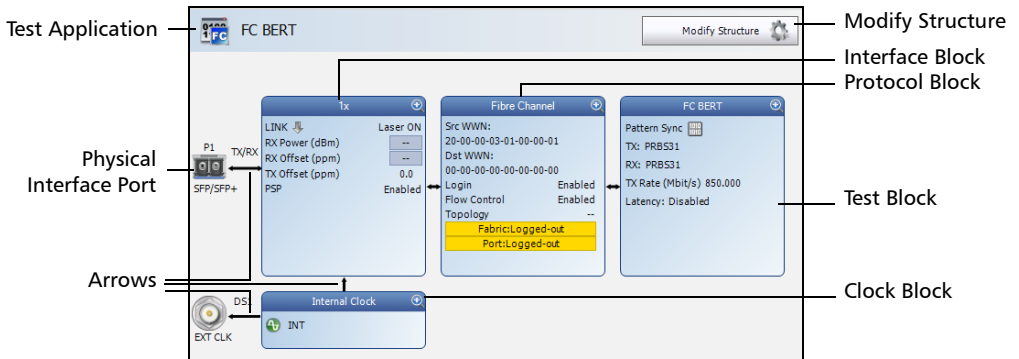



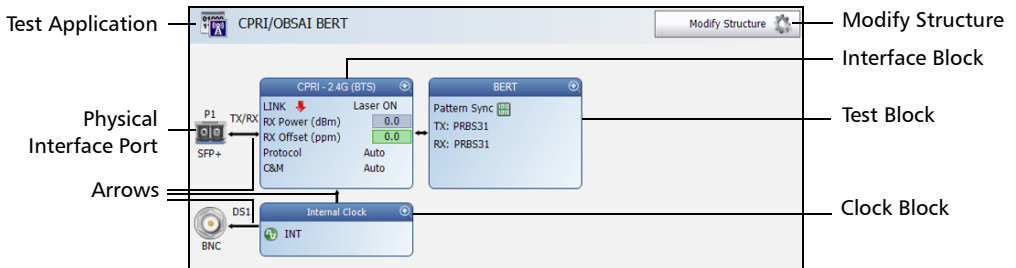

➤ Wireless Test Application:











Test Setup - Test Configurator, Timer, and System

Test Configurator Overview

- Test Application indicates the selected test application.
- Topology, for Transport Test Applications, indicates the selected test topology.
- Modify Structure button, allows the configuration of the physical port and the signal interface structure.
- Port Status icon and its description for a CFP4/CFP8/QSFP interface is only displayed when validating or if there is an problem as described in the following table.

	Validating transceiver.
	Missing transceiver.
	Invalid transceiver or mismatch with the selected signal/interface.
	Valid transceiver matching the selected interface/rate. This icon is not displayed here, it is only displayed for the Physical Interface Port.

- TA Status for a transceiver adapter is only displayed when there is a warning or a problem as described in the following table.

Icon	Displayed Message	Description
	Port A/B - Insertion counter approaching the limit	TA insertion counter exceeds the insertion counter threshold (90%).
	Port A/B - Insertion limit is reached	TA insertion counter exceeds the module insertion limit.
	A1/A2/B1/B2 - Insertion counter approaching the limit	Optical transceiver module insertion counter exceeds the insertion counter threshold (90%).
	A1/A2/B1/B2 - Insertion limit is reached	Optical transceiver module insertion counter exceeds the insertion limit.
	Port A/B - The battery for the insertion counter is low, please contact EXFO Support	The battery is low and must be replaced by an EXFO authorized service center.
	Port A/B - The battery for the insertion counter is depleted, please contact EXFO Support	The battery is dead and must be replaced by an EXFO authorized service center.
	A1/A2/B1/B2 - Missing TA-... Adaptor	No TA detected
	A1/A2/B1/B2 - Validating TA-...	Validation process is on-going
	A1/A2/B1/B2 - Invalid TA-... Adaptor	Validating process completed and incompatibility has been found

- Physical Interface Port indicates the physical interface port. For **Dual Port** topology, there is a physical interface for each port.

The status icon for a physical CFP4/CFP8/QSFP interface is displayed as described in Port Status above.

Test Setup - Test Configurator, Timer, and System

Test Configurator Overview

- Arrows are used to indicate the interconnection between blocks as well as the direction of the clock and data flow.

A line with an arrow on both ends indicates a bidirectional communication (TX/RX).

A line with a single arrow indicates a unidirectional communication, either **TX** when going out of a block or **RX** (or **RX2**) when going into a block. **RX2** indicates the physical **BNC TX/RX2** port.

A line going out of a block returning back to the same block, indicates a loopback communication.
- Physical Clock Port indicates the direction, TX or RX, of the selected clock. The arrow next to the physical clock image indicates if a clock is generated (TX, arrow pointing to the left) or received (RX, arrow pointing to the right) at/from the physical EXT CLK port.
- Physical External Reference Port indicates the port, signal, and direction (RX) of the selected external reference signal.
- Interface Block displays an overview of the interface settings and status. Tap on the interface block to change the settings and to see detailed status. For **Dual Port** topology, there is an interface block for each port.
- Protocol Block displays an overview of either the frame structure and its parameters for Ethernet test applications or the embedded signal for Transport test applications. This block is not present for all tests. Tap on the protocol block to change the settings and to see detailed status. For RFC 2544, EtherBERT, and Traffic Gen & Mon in **Dual Port** topology, there is a protocol block for each port.
- Test Block displays an overview of the test settings and status. Tap on the test block to change the settings and to see detailed status.

- Clock Block displays an overview of the clock settings and status. Tap on the clock area to change the settings and to see detailed status. For **Dual Port** topology, the clock block is not present but the clock is set to **Internal**.
- External Reference Block displays an overview of the external reference signal settings and status. Tap on the external reference area to change the settings and to see detailed status.

Modify Structure Button

From the **Test** menu, tap **Setup**, **Test Configurator**, and the **Modify Structure** button.

For Transport Test Applications

TX/RX allows the configuration of the following parameters for either TX/RX, TX1/RX1 and RX2, TX, or RX depending on the selected topology.

- **Interface/Rate:** Select the desired interface rate. Choices depend on the selected test and the rates available on the module.

Test	Interface/Rate
OTN (Parallel)	OTU4 (4 Lanes) [111.81 Gbit/s] OTU3e2 (4 Lanes) [44.583 Gbit/s] OTU3e1 (4 Lanes) [44.571 Gbit/s] OTU3 (4 Lanes) [43.018 Gbit/s]
OTN (Serial)	OTU2 [10.709 Gbit/s] OTU1e [11.049 Gbit/s] OTU2e [11.096 Gbit/s] OTU1f [11.270 Gbit/s] OTU2f [11.318 Gbit/s] OTU1 [2.666 Gbit/s]
SONET	OC-192 [9.953 Gbit/s] OC-48 [2.488 Gbit/s] OC-12 [622.08 Mbit/s] OC-3 [155.520 Mbit/s] OC-1 [51.840 Mbit/s] STS-3e [155.520 Mbit/s] STS-1e [51.840 Mbit/s]
SDH	STM-64 [9.953 Gbit/s] STM-16 [2.488 Gbit/s] STM-4 [622.080 Mbit/s] STM-1 [155.520 Mbit/s] STM-0 [51.840 Mbit/s] STM-1e [155.520 Mbit/s] STM-0e [51.840 Mbit/s]

Test Setup - Test Configurator, Timer, and System

Modify Structure Button

Test	Interface/Rate
DSn	DS1 [1.544 Mbit/s] DS3 [44.736 Mbit/s]
PDH	E1 [2.048 Mbit/s] E3 [34.368 Mbit/s] E4 [139.264 Mbit/s]
NI/CSU Emulation	DS1

➤ **Connector** allows the selection of the module's port.

Interface/Rate	Connector ^a	
	8870/8880	88200NGE
OTU4 (4 Lanes) [111.81 Gbit/s]	-	Port 1 - CFP4 Port 2 - QSFP ^b
OTU3e2 (4 Lanes) [44.583 Gbit/s] OTU3e1 (4 Lanes) [44.571 Gbit/s] OTU3 (4 Lanes) [43.018 Gbit/s]	-	Port 2 - QSFP ^b
OTU2 [10.709 Gbit/s] OTU1e [11.049 Gbit/s] OTU2e [11.096 Gbit/s] OTU1f [11.270 Gbit/s] OTU2f [11.318 Gbit/s] OC-192 [9.953 Gbit/s] STM-64 [9.953 Gbit/s]	Port 1 - SFP+ ^c	Port 1 - SFP+
OTU1 [2.666 Gbit/s] OC-48 [2.488 Gbit/s] OC-12 [622.08 Mbit/s] OC-3 [155.520 Mbit/s] OC-1 [51.840 Mbit/s] STM-16 [2.488 Gbit/s] STM-4 [622.080 Mbit/s] STM-1 [155.520 Mbit/s] STM-0 [51.840 Mbit/s]		
STS-3e [155.520 Mbit/s] STS-1e [51.840 Mbit/s] STM-1e [155.520 Mbit/s] STM-0e [51.840 Mbit/s]	BNC	-

Test Setup - Test Configurator, Timer, and System

Modify Structure Button

Interface/Rate	Connector ^a	
	8870/8880	88200NGE
DS1 [1.544 Mbit/s]	Bantam RJ48C	-
E1 [2.048 Mbit/s]	Bantam BNC RJ48C	-
DS3 [44.736 Mbit/s] E3 [34.368 Mbit/s] E4 [139.264 Mbit/s]	BNC	-

- Availability of connectors depend on the model.
- This port accepts QSFP+ or QSFP28 transceivers.
- Port 2 is used with OC-192/STM-64 in **Decoupled (TX≠RX)** mode.

➤ **Framing**

Note: For OTN BERT, and SONET/SDH BERT test applications for rates up to 10G, the framing is set to **Framed**.

For OTN BERT test application, parallel interfaces, allows the selection of the test framing type. For serial interfaces, Multi-Channel OTN, OTN BERT, and SONET/SDH BERT test applications, the **Framing** is set to **Framed**. For OTN - SONET/SDH BERT test application, the test is framed.

➤ **Framed (default):** A single Pattern or Ethernet client applied toward the physical lanes.

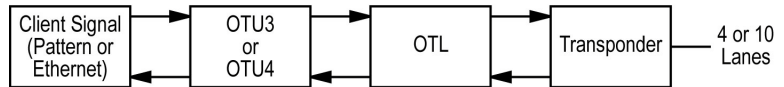

➤ **20 Unframed Logical Lanes:** Independent test pattern in each logical lane. Available with: **OTU4 (4 Lanes) [111.81 Gbit/s]**.

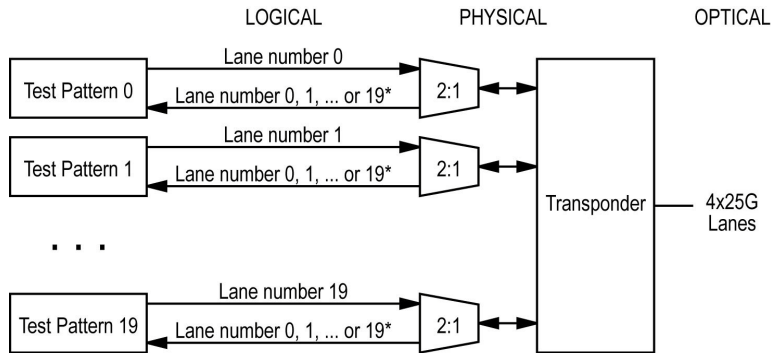

* It is not possible to predict on which Lane a generated pattern will be detected on the receive side.

Test Setup - Test Configurator, Timer, and System

Modify Structure Button

- **4 Unframed Physical Lanes:** Independent test pattern in each physical lane. Available with:
OTU3 (4 Lanes) [43.018 Gbit/s],
OTU3e1 (4 Lanes) [44.571 Gbit/s],
OTU3e2 (4 Lanes) [44.583 Gbit/s], and
OTU4 (4 Lanes) [111.81 Gbit/s]

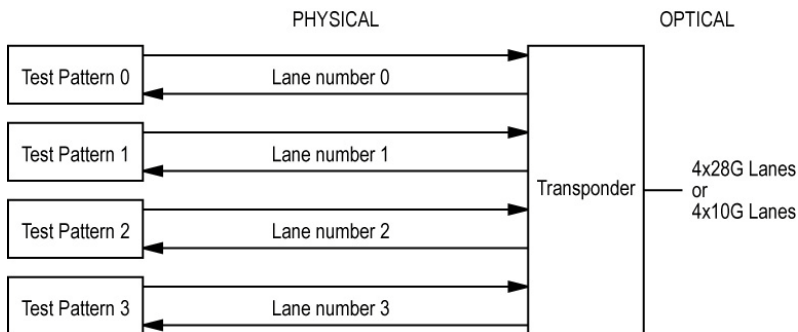

- **OTN Multiplexing - Config Mux** button allows the selection of the OTN test mapping including the selection of the payload type (PT20 or PT21) when applicable. Refer to *OTN BERT* on page 45 and *OTN-SONET/SDH BERT* on page 47 for supported path/mapping.

Note: For Multi-Channel OTN, ODU0 mapping is selected by default and the **OTN Multiplexing** field is not displayed. Refer to *Modify Trib Slots/Channels* on page 240 for test mapping selection and *Multi-Channel OTN* on page 44 for supported path/mapping.

Interface/Rate	OTN Multiplexing
OTU1 [2.666 Gbit/s]	ODU1 ODU1/ODU0
OTU2 [10.709 Gbit/s]	ODU2 ODU2/ODU1 ODU2/ODU1/ODU0 ODU2/ODU0 ODU2/ODUflex
OTU1e [11.049 Gbit/s]	ODU1e
OTU2e [11.096 Gbit/s]	ODU2e
OTU1f [11.270 Gbit/s]	ODU1f
OTU2f [11.318 Gbit/s]	ODU2f
OTU3 (4 Lanes) [43.018 Gbit/s]	ODU3 ODU3/ODU2 ODU3/ODU2/ODU1 ODU3/ODU2/ODU1/ODU0 ODU3/ODU1 ODU3/ODU1/ODU0 ODU3/ODU0 ODU3/ODUflex
OTU3e1 (4 Lanes) [44.571 Gbit/s]	ODU3e1
OTU3e2 (4 Lanes) [44.583 Gbit/s]	ODU3e2

Test Setup - Test Configurator, Timer, and System

Modify Structure Button

Interface/Rate	OTN Multiplexing
OTU4 (4 Lanes) [111.81 Gbit/s]	ODU4 (default) ODU4/ODU3 ODU4/ODU3/ODU2 ^a ODU4/ODU3/ODU2/ODU1 ^a ODU4/ODU3/ODU2/ODU1/ODU0 ^a ODU4/ODU3/ODU1 ^a ODU4/ODU3/ODU0 ^a ODU4/ODU2 ODU4/ODU2/ODU1/ODU0 ^a ODU4/ODU2/ODU1 ^a ODU4/ODU2/ODU0 ^a ODU4/ODU2/ODUflex ^a ODU4/ODU1 ODU4/ODU1/ODU0 ^a ODU4/ODU0 ODU4/ODU2e ^a ODU4/ODU1e ^a ODU4/ODUflex ^a

a. Only available on 88200NGE.

- **Embedded SONET/SDH**, only available with **OTN-SONET/SDH BERT** test application, allows the selection of the embedded SONET/SDH signal.

OTN Multiplexing	Embedded SONET/SDH
ODU4/ODU3 ^a ODU3	OC-768, STM-256
ODU4/ODU3/ODU2 ^a ODU4/ODU2 ^a ODU3/ODU2 ODU2	OC-192, STM-64
ODU4/ODU3/ODU2/ODU1 ^a ODU4/ODU3/ODU1 ^a ODU4/ODU2/ODU1 ^a ODU4/ODU1 ^a ODU3/ODU2/ODU1 ODU3/ODU1 ODU2/ODU1 ODU1	OC-48, STM-16
ODU4/ODU3/ODU2/ODU1/ODU0 ^a ODU4/ODU3/ODU0 ^a ODU4/ODU2/ODU1/ODU0 ^a ODU4/ODU2/ODU0 ^a ODU4/ODU1/ODU0 ^a ODU4/ODU0 ^a ODU3/ODU2/ODU1/ODU0 ODU3/ODU1/ODU0 ODU3/ODU0 ODU2/ODU1/ODU0 ODU2/ODU0 ODU1/ODU0	OC-3, OC-12, STM-1, STM-4

a. Only available on 88200NGE.

Test Setup - Test Configurator, Timer, and System

Modify Structure Button

- **SONET/SDH Multiplexing - Config Mux** button allows the selection of SONET/SDH multiplexing. Available with OTN-SONET/SDH and SONET/SDH BERT test applications.

Interface/Rate or Embedded SONET/SDH	SONET/SDH Multiplexing
OC-768	STS-768c, STS-192c, STS-48c, STS-12c, STS-3c, STS-1
STM-256	AU-4-256c, AU-4-64c, AU-4-16c, AU-4-4c, AU-4, AU-3
OC-192	STS-192c, STS-48c, STS-12c, STS-3c, STS-1, STS-1/VT2, STS-1/VT1.5
STM-64	AU-4-64c, AU-4-16c, AU-4-4c, AU-4, AU-4/TU-3, AU-4/TU-12, AU-4/TU-11, AU-3, AU-3/TU-12, AU-3/TU-11
OC-48	STS-48c, STS-12c, STS-3c, STS-1, STS-1/VT2, STS-1/VT1.5
STM-16	AU-4-16c, AU-4-4c, AU-4, AU-4/TU-3, AU-4/TU-12, AU-4/TU-11, AU-3, AU-3/TU-12, AU-3/TU-11
OC-12	STS-12c, STS-3c, STS-1, STS-1/VT2, STS-1/VT1.5
STM-4	AU-4-4c, AU-4, AU-4/TU-3, AU-4/TU-12, AU-4/TU-11, AU-3, AU-3/TU-12, AU-3/TU-11
OC-3	STS-3c, STS-1, STS-1/VT2, STS-1/VT1.5
STM-1	AU-4, AU-4/TU-3, AU-4/TU-12, AU-4/TU-11, AU-3, AU-3/TU-12, AU-3/TU-11
OC-1	STS-1, STS-1/VT2, STS-1/VT1.5
STS-3e	STS-3c, STS-1, STS-1/VT2, STS-1/VT1.5
STS-1e	STS-1, STS-1/VT2, STS-1/VT1.5
STM-0	AU-3, AU-3/TU-12, AU-3/TU-11
STM-1e	AU-4, AU-4/TU-3, AU-4/TU-12, AU-4/TU-11, AU-3, AU-3/TU-12, AU-3/TU-11
STM-0e	AU-3, AU-3/TU-12, AU-3/TU-11

- **DSn/PDH Multiplexing**, available with **DSn/PDH** test application, allows the selection of the DSn/PDH multiplexing.

Interface/Rate	DSn/PDH Multiplexing
DS3	None (default), DS1, E1
DS1	None
E4	None (default), E3, E3/E2/E1
E3	None (default), E2/E1
E1	None

- **Client** allows the selection of either **Pattern** (default) or an EoOTN (**1 GbE**, **10 GbE**, **40 GbE**, **100 GbE**, or **Ethernet (flex/GFP-F)**) client. The client is set to **Pattern** for OTU1f, OTU2f, OTU3e1, OTU3e2, parallel interfaces/rates, as well as for **Multi-Channel OTN**, **OTN-SONET/SDH BERT** and **SONET/SDH** test applications.

Test Setup - Test Configurator, Timer, and System

Modify Structure Button

- **Topology** allows the selection of the network test topology. Only **Coupled (TX=RX)** is available with Multi-Channel OTN.
- **Coupled (TX=RX)** uses the same settings for both the TX and RX signals.

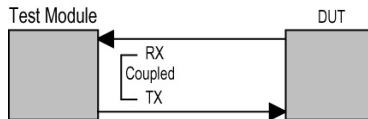

- **Decoupled (TX≠RX)**, supported with **SONET/SDH BERT** on 8870/8880 module, **DSn/PDH BERT**, and **SONET/SDH - DSn/PDH** test applications, uses independent settings for TX and RX signals. However, the pattern and some other parameters are always coupled.

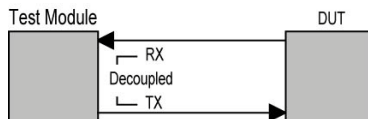

- **Through** loops the RX signal to the TX port without TX overwrite capabilities.

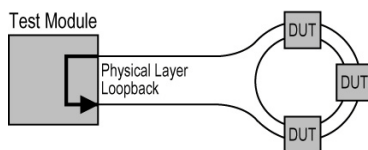

- **Through Intrusive** loops the RX signal to the TX port with TX overwrite capabilities. Only available with OTN rates.

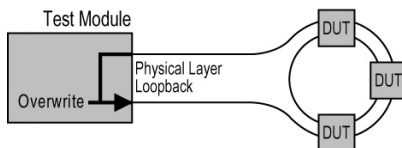

- **Dual RX** uses two DS1 or DS3 signals at the same time. Both RX ports are coupled at the exception of the termination mode. Only available with DS1 and DS3 signal rates.

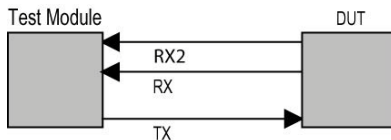

Test Setup - Test Configurator, Timer, and System

Modify Structure Button

For Ethernet Test Applications

- **Port 1** and **Port 2** are only displayed when **Dual Port** topology is selected and allows configuring each port individually.
- **Interface/Rate** choices depend on the selected test and the rates available on the module.

Test	Interface/Rate
EtherSAM RFC 2544 RFC 6349 EtherBERT Traffic Gen & Mon Smart Loopback	400GE (8 Lanes) [425 Gbit/s] ^a 100GE (4 Lanes) [103.125 Gbit/s] 40GE (4 Lanes) [41.25 Gbit/s] 25GE ^b 10GE WAN ^c 10GE LAN 1GE Optical 100M Optical 10/100/1000M Electrical ^d
Carrier Ethernet OAM	10GE WAN 10GE LAN 1GE Optical 100M Optical 10/100/1000M Electrical
Through Mode	100GE (4 Lanes) [103.125 Gbit/s] ^e 10GE LAN 1GE Optical 100M Optical 10/100/1000M Electrical ^f
TCP Throughput	1GE Optical 100M Optical 10/100/1000M Electrical
Cable Test	10/100/1000M Electrical

- Only available for EtherBERT.
- Only available for RFC 2544, EtherBERT, Traffic Gen & Mon, and Smart Loopback.
- Not available with RFC 6349 test application.
- Also available as a second port when the test application requires two ports; Ethernet 10/100/1000 Mbit/s electrical is supported when using an active copper SFP.
- Only supported on the 88200NGE.
- Ethernet 10/100/1000 Mbit/s electrical is supported when using an active copper SFP and the RJ45 port.

- **PHY Type** allows selecting the 100GE (4 Lanes) CFP4/QSFP transceiver PHY type: **LR4/ER4** (default), **SR4**, **CWDM4**, **CLR4**, or **Other**. The PHY type when set to any except **LR4/ER4**, allows enabling RS-FEC (see page 182); ensure both ends of the circuit have the FEC enabled. Only available with 100GE (4 Lanes) framed Ethernet interface.
- **Primary Port / Secondary Port**, available with Through Mode test application, allows selecting the module's ports that are respectively used as primary (Port 1) and secondary (Port 2) port. The configuration of the network configuration parameters will be available on the Primary Port only.
- **Connector** allows the selection of the module's port.

Interface/Rate	Connector ^a			
	8870/8880	88200NGE	88260	88400NGE
400GE (8 Lanes) [425 Gbit/s]	-	-	-	Port 1 - CFP8
100GE (4 Lanes) [103.125 Gbit/s]	-	Port 1 - CFP4 Port 2 - QSFP ^b	-	-
40GE (4 Lanes) [41.25 Gbit/s]	-	Port 2 - QSFP ^b	-	-
25GE	-	-	Port A1 - SFP28 Port A2 - SFP28 Port B1 - SFP28 Port B2 - SFP28	-
10GE WAN 10GE LAN 1GE Optical 100M Optical	Port 1 - SFP+ Port 2 - SFP+	Port 1 - SFP+	-	-
10/100/1000M Electrical	Port 1 - RJ45 Port 2 - SFP+ (RJ45) ^{c, d}	Port 1 - SFP+ (RJ45) ^d	-	-

- a. Availability of connectors depend on the model.
- b. This port accepts QSFP+ or QSFP28 transceivers.
- c. Only available as a second port when the test application requires two ports.
- d. Ethernet 10/100/1000M electrical is supported when using an active copper SFP.

Test Setup - Test Configurator, Timer, and System

Modify Structure Button

- **Framing**, available for EtherBERT test application, allows the selection of the test framing type; otherwise the framing is set to Framed Layer 2. See *Network* on page 220 for more information on frame format.

The framing is not configurable and set to **Framed Layer 2** for 40GE/100GE dual port topology and for 400GE test.

- **Framed Layer 1**: Frame of x bytes that allows connection to any interface that complies with 802.3 Ethernet PHY or DWDM fibre. Available with rate up to 10G WAN.

IFG (Min. 12 bytes)	Preamble (7 bytes)	SFD (1 byte)	Test Pattern (Length: 48 to 10/16 Kbytes)
------------------------	-----------------------	-----------------	--

- **Framed Layer 2**: Frames of x^1 bytes without network layer (**None**) that complies with IEEE 802a Ethernet II standard.

SOF	Destination Address	Source Address	Type	Test Pattern (Configurable length)	FCS	IFG
-----	---------------------	----------------	------	---------------------------------------	-----	-----

- **Framed Layer 3/4** (default): Frames of x^1 bytes with UDP (default) or TCP network layer that complies with IEEE 802a Ethernet II standard.

SOF	Destination Address	Source Address	Type	IP Header	UDP Header	BERT Tag	Test Pattern (Configurable length)	FCS	IFG	
SOF	Destination Address	Source Address	Type	IP Header	TCP Header	BERT Tag	Test Pattern (Configurable length)	TCP Checksum Cancellor	FCS	IFG

1. To set the frame length, see Frame Size on page 161 for EtherBERT (Ethernet and EoOTN) and page 254 for RFC 2544.

- **Unframed (Interop)** is only available with optical interface up to 25GE:

For **Seed A** and **Seed B**, available with 10G LAN and 25G, the pattern is generated by the PCS scrambler from a specific seed. The pattern is not encoded.

For **PRBS31 Unscrambled**, available with 10G LAN and 25G, the pattern is generated at the PCS layer. The pattern is not encoded and not scrambled.

For **PRBS** and **User Pattern**: Pattern generated by the PCS scrambler. The pattern is encoded.

IFG (Min. 12 bytes)	Preamble (7 bytes)	SFD (1 byte)	Test Pattern (Length: infinite)
------------------------	-----------------------	-----------------	------------------------------------

- **Unframed** is only available with optical interface up to 10G LAN:
Encoded pattern generated by the PCS scrambler.

IFG (Min. 12 bytes)	Preamble (7 bytes)	SFD (1 byte)	Test Pattern (Length: infinite)
------------------------	-----------------------	-----------------	------------------------------------

- **Unframed with Sync** is only available with optical interface up to 10G LAN: Pattern of a length corresponding to the number of bytes transmitted in 1 second.

IFG (Min. 12 bytes)	Preamble (7 bytes)	SFD (1 byte)	Test Pattern (Length: about 1 second)
------------------------	-----------------------	-----------------	--

Test Setup - Test Configurator, Timer, and System

Modify Structure Button

- **20 Unframed PCS:** Independent infinite length test pattern in each PCS lane (no blocks and no lane markers). Available with 100GE (4 Lanes).

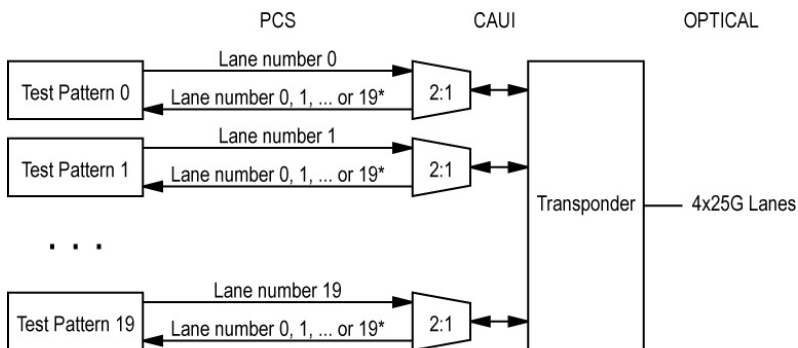

* It is not possible to predict on which Lane a generated pattern will be detected on the receive side.

- **4 Unframed XLAUI:** Independent infinite length test pattern in each XLAUI lane (no blocks). Available with 40GE (4 Lanes).

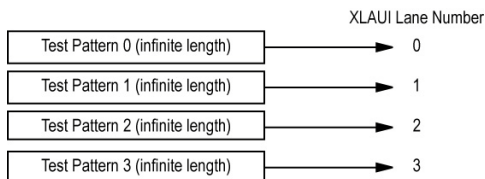

- **4 Unframed CAUI-4:** Independent infinite length test pattern in each CAUI-4 lane (no blocks). Available with 100GE (4 Lanes).

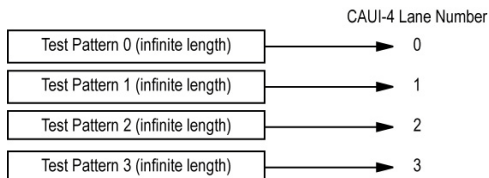

➤ Loopback Mode

Note: Only available for Smart Loopback Ethernet test application.

Transparent (Pseudo-Physical) check box when selected (cleared by default) determines that the Smart Loopback operates as a physical loopback by transmitting all received frames unaltered and without discrimination. When the check box is cleared, the Loopback mode is selectable from *Loopback* on page 311.

In transparent mode, the **Network** tab and the **Ping & Trace Route** functions are not available.

Note: The **Transparent** mode is intended to be used for point-to-point topology, not for switched or routed networks. Use the **Transparent** mode with caution because all received frames are looped back without discrimination.

➤ Topology allows the selection of the network test topology: **Single Port** (default) or **Dual Port**.

Dual Port is only available with:

- EtherSAM, RFC 2544, and Traffic Gen & Mon for rates up to 10G WAN.
- EtherBERT for either rates up to 10G WAN framed/unframed or for rates 40/100G Framed Layer 2.

➤ OAM Type

- Only available for Carrier Ethernet OAM test application.

Selects the type of Carrier OAM network: **Ethernet OAM** (S-OAM; default), **MPLS-TP OAM**, or **Link OAM**.

- **S-OAM** check box when selected enables S-OAM on all services. Available for rates up to 10G WAN.

Test Setup - Test Configurator, Timer, and System

Modify Structure Button

For Sync Test Applications

- **Interface/Rate:** Select the desired interface rate. Choices depend on the selected test and the rates available on the module.

Test	Interface/Rate
1588 PTP SyncE	10GE LAN 1GE Optical 100M Optical 10/100/1000M Electrical ^a
Wander	10GE LAN 1GE Optical 100M Optical 10/100/1000M Electrical ^a DS1 [1.544 Mbit/s] E1 [2.048 Mbit/s] 10 MHz 2 MHz 1PPS

- a. The 10M rate is not available for Wander test application.

- **Connector:** Allows the selection of the module's port available for the selected interface/rate.

Interface/Rate	Connector ^a	
	8870/8880	88200NGE
10GE LAN 1GE Optical 100M Optical	Port 1 - SFP+ Port 2 - SFP+ ^b	Port 1 - SFP+
10/100/1000M Electrical	Port 1 - RJ45	Port 1 - SFP+ (RJ45) ^c
10 MHz 2 MHz 1PPS	BNC (Port labelled TX/RX2) RJ48C	-

- a. Availability of connectors depend on the model.
- b. Not available with Wander.
- c. Ethernet 10/100/1000 Mbit/s electrical is supported when using an active copper SFP.

Test Setup - Test Configurator, Timer, and System

Modify Structure Button

For Fibre Channel Test Application

- **Interface/Rate** choices depend on the rates available on the module.

Interface/Rate	Connector ^a	
	8870-8880	88200NGE
1X	Port 1 - SFP+ Port 2 - SFP+	Port 1 - SFP+
2X		
4X		
8X		
10X		
16X	-	

a. Availability of connectors depend on the model.

- **Connector** allows the selection of the module's port available for the selected interface/rate (see above table).

For Wireless Test Application

- **Port 1** and **Port 2** are only displayed when **Dual Port** topology is selected and allows configuring each port individually.
- **Interface/Rate** allows the selection of the interface rate.

Interface Rate	Connector ^a	
	8870/8880	88200NGE
CPRI - 1.2G	Port 1 - SFP+ Port 2 - SFP+	Port 1 - SFP+
CPRI - 2.4G		
CPRI - 3.1G		
CPRI - 4.9G		
CPRI - 6.1G		
CPRI - 9.8G		
OBSAI - 1.5G		
OBSAI - 3.1G		
OBSAI - 6.1G		

a. Availability of connectors depend on the model.

- **Connector** is the module's port available for the selected interface/rate (see table above).
- **Framing**
 - **Framed L2** (default) is mainly used to validate connectivity with the base station (REC) or remote radio head (RE) over the fiber interface.
 - **Unframed** is mainly used to validate the continuity of the dark fiber at CPRI or OBSAI (3.1 Gbit/s) rate.

Test Setup - Test Configurator, Timer, and System

Modify Structure Button

- **Emulation Mode** is available with **Framed L2**
 - **Base Station** (default) is used to validate the connectivity with the RRH.

For CPRI, it initiates the start-up sequence and provides synchronization with the RRH.

For OBSAI, it initiates the State Machine events and provides synchronization with the RRH.
 - **Remote Radio Head** is used to validate the communication with a base station.

For CPRI, it begins its start-up sequence when it detects a valid signal from the base station.

For OBSAI, the State Machine events depend on the Base Station signal transmission.
- **Topology** allows the selection of the network test topology: **Single Port** (default) or **Dual Port**. Dual Port is only available with CPRI Framed L2.

Signal Auto-Detect

The Signal Auto-Detect allows the detection of the DS1/DS3 interface **Line Coding** (DS1), **Framing**, and **Test Pattern**.

Signal Auto-Detect is only available:

- with DS1 and DS3 interfaces.
- when the test is stopped.
- when Loopback is not activated for NI/CSU Emulation test.

Note: *Test Pattern is not detected with NI/CSU Emulation test application.*

During the detection process, the following messages may be displayed: **Detecting**, **Successful**, and/or **Failed**.

When the auto-detection is successful, the detected parameters are automatically applied as the test interface configuration.

Upon detection of specific alarms, the detection may not be possible, tap **Retry** to invoke the detection again.

1588 PTP

From the **Test** menu, tap **Setup, Test Configurator**, and the 1588 PTP test block.

PTP

Note: Refer to Status Bar on page 28 for PTP link status.

➤ Profile

- **ITU G.8265.1** (default), also called Telecom Profile, is for frequency synchronization.
- **ITU G.8275.1**, also called Telecom Profile with full timing support from the network, is for very accurate phase/time synchronization required by new mobile applications.
- **Domain** is the PTP domain parameter used by the 1588 PTP function to communicate with the Grand Master clock: **0** to **255**. However, the standard values are: **4** (default) to **23** for G.8265.1 and **24** (default) to **43** for G.8275.1.
- **Framing** is not selectable and is set to **UDP/IPv4** for G.8265.1 and **Ethernet** for G.8275.1.
- **Mode** is not configurable and is set to **Unicast** for G.8265.1 and **Multicast** for G.8275.1.
 - **Unicast** implies a dedicated communication link between the master and the slave clock.
 - **Multicast** implies that a master clock send its Sync/Follow Up and Delay Response in a multicast mode.
- **Multicast MAC**, available with ITU G.8275.1, is the multicast address used to send the delay request: **01-1B-19-00-00-00** (forwardable; default), **01-80-C2-00-00-0E** (non-forwardable), or **User Defined** (default **User Defined** address is **01:1B:19:00:00:01**).

- **GM IP Address**¹ is the IP address of the Grand Master Clock used by the 1588 PTP function to communicate with it.
- **Quick Ping**¹ button allows testing if the Grand Master IP address can be reached. A message is returned indicating if the ping attempt was **Successful** or **Failed**.
- **IP TOS/DS**¹ allows entering the Type of Service: **0x00** (default) to **0xFF**.
- **Mechanism** is not selectable and is set to **Delay Req-Resp** (Delay Request-Response) which specifies the mechanism used by the 1588 PTP function to communicate with the Grand Master clock. Refer to *Delay Request-Response* on page 697 for more information.
- **Delay Mode** is not selectable and is set to **Two-way** which uses Sync/Follow Up, Delay Request, and Delay Response messages.
- **Connect**¹ button is used to initiate the Grand Master Connection process. This process is also automatically initiated when starting the test if not already initiated. The process automatically ends when stopping the test.
- **Negotiation Status**¹ is displayed during the Unicast negotiation process which is initiated when either the test is started or the **Connect** button is activated. See *Negotiation Status* on page 475 for more information.

1. Only available with Unicast mode.

- **Message Rate**
 - **Announce** determines the transmission interval of the Announce messages:

Configurable for G.8265.1: **1 msg/16s, 1 msg/8s, 1 msg/4s, 1 msg/2s** (default), **1 msg/s, 2 msg/s, 4 msg/s, or 8 msg/s**.

For G.8275.1, indicates the announce rate log message interval.
 - **Sync** determines the transmission interval of the Sync messages:

Configurable for G.8265.1: **1 msg/16s, 1 msg/8s, 1 msg/4s, 1 msg/2s** (default), **1 msg/s, 2 msg/s, 4 msg/s, or 8 msg/s. 16 msg/s, 32 msg/s** (default), **64 msg/s, or 128 msg/s**

For G.8275.1, indicates the sync rate log message interval.
 - **Delay-Request** determines the transmission interval of the Delay Request messages: **1 msg/16s, 1 msg/8s, 1 msg/4s, 1 msg/2s** (default), **1 msg/s, 2 msg/s, 4 msg/s, or 8 msg/s. 16 msg/s** (default for G.8275.1), **32 msg/s** (default for G.8265.1), **64 msg/s, or 128 msg/s**. The **Delay-Request** message rate is limited by the Sync rate selection; the Delay-Request message rate is automatically updated to be smaller than or equal to the **Sync** message rate.
- **Service Duration** (only available with **Unicast** mode)
 - **Lease Duration** is not configurable and is set to **300** seconds which determines the Lease Duration used between the 1588 PTP function and the Grand Master clock.
 - **Renewal Interval** is not configurable and is set to **150** seconds which determines the interval used by the 1588 PTP function to initiate the renewal of its lease with the Grand Master clock.

➤ GM Info

Note: *Only available when Grand Master clock information is available.*

The Grand Master Information window displays the decoded clock information.

For G.8265.1 only:

- **Identity** reports the 8-byte identification code of the Grand Master Clock.

For G.8275.1 only:

- **Port Identity** reports the identity type of the PTP port.
- **GM Identity** reports the clock identity of the Grand Master Clock.
- **Priority 1** reports the priority 1 attribute of the Grand Master Clock.
- **Priority 2** reports the priority 2 attribute of the Grand Master Clock.
- **Steps Removed** reports the number of communication paths crossed between the local clock and the Grand master Clock.
- **Log Message Interval (Announce)** reports the mean time interval between successive Announce messages.
- **Log Message interval (Sync)** reports the mean time interval between successive Sync messages.

Test Setup - Test Configurator, Timer, and System

1588 PTP

For both G.8265.1 and G.8275.1:

- **Clock Class** reports the description and code of the Grand Master Clock Class.

Code	Description
0-5, 8-12, 15-51, 53-57, 59-67, 123-132, 171-186, 188-192, 194-215, 233-247, 249-254	Reserved
6	Sync to primary reference
7, 14	Holdover
13	Sync to application-specific reference
52, 58, 187, 193	Degraded
68 to 79, 81-109 (odd values), 11-122, 133-170, 216-232	Alternate PTP profiles
80-110 (even values) ^a	Quality Level (QL-xxx ^a)
248	Default
255	Slave only

a. Refer to QL table on page 448 for the list of Quality Level values that will be used as the description.

- **Clock Mode** reports the description of the Grand Master Clock Mode: **Two-step** or **One-step**.
- **Clock Accuracy** reports the accuracy of the clock.
- **Time Source** reports the source of time used by the Grand Master Clock.

Alarm Timeout/Threshold

Note: *The following parameters are also used to declare the Pass/Fail verdict.*

- **Receipt Timeout** defines the threshold used to declare a **Loss Announce** or **Loss Sync** message alarm: **2** to **255** messages (default is **3** messages). A message is considered lost if not received within its expected arrival time and a loss alarm is declared when the number of consecutive lost messages is greater than or equal to the defined **Receipt Timeout**.
- **IPDV Threshold** defines the inter packet delay variation threshold used to raise the **Unusable** message alarm. The alarm is raised when IPDV is not within the configured **IPDV Threshold: 0.001** to **1000ms** (default is **2ms**). The minimum value of 0.001 is adjusted when the **Sync** or **Delay Req** is set to 4 messages/s or less.

Quality Level

The quality level characterizes the clock quality in terms of network synchronization.

- **QL Mismatch Monitoring** when selected (default) enables the Quality Level mismatch monitoring.
- **Expected QL** allows, when **QL Mismatch Monitoring** check box is selected, the selection of the Expected Quality Level value: default value is **QL-EEC2/ST3** for G.8265.1 and **QL-SSU-B/ST3E** for G.8275.1. Refer to page 448 for more information.

Pass/Fail Verdict

Pass/Fail Verdict check box when selected (default) enables the use of the pass/fail verdict. The global pass/fail verdict is based on the following criteria: alarms (**Link Down**, **Loss Sync**, **Loss Announce**, **Unusable** (G.8265.1), and/or **QL Mismatch** (when **QL Mismatch Monitoring** is enabled)), or the test is automatically aborted (service request denied, session canceled, or no reply for G.8265.1; sync message rate changed for G.8275.1).

Restore 1588 PTP Defaults

Reverts the 1588 PTP test application to its default factory settings.

BERT and Unframed BERT

Note: Available with Pattern client. For EtherBERT unframed test up to 10GE, refer to EtherBERT, FC BERT, BERT (CPRI/OBSAI), and Unframed BERT on page 155.

From the **Test** menu, tap **Setup**, **Test Configurator**, and tap on the **BERT** or **Unframed BERT** block.

Pattern

The icon next to the **Pattern** label indicates the status of the received pattern signal. Refer to *Status Bar* on page 28 for more information.

- **TX Rate**, available with ODUflex mapped to pattern, allows the selection of the transmission rate. Unit choices are %, **Kbit/s**, **Mbit/s**, and **Gbit/s** (default).
- **Coupled RX to TX** check box, when selected (default), allows coupling both the TX and RX signal with the same test pattern.

For a framed test, the **Coupled RX to TX** check box is selected and cannot be cleared.

For an unframed test, the **Coupled RX to TX** check box is selectable (selected by default) when **All Lanes** is selected.

- **No Pattern Analysis (Live)** check box when cleared (default), monitors the received traffic pattern. For live traffic, the **No Pattern Analysis (Live)** check box should be selected as the traffic is a live pattern thus there is no analysis of pattern loss, bit error, and no traffic indications. Only available with a framed test.

Test Setup - Test Configurator, Timer, and System

BERT and Unframed BERT

- **TX Pattern/RX Pattern** sets respectively the TX and RX test pattern.

OTN, SONET/SDH, and EtherBERT 40GE/100GE Unframed:

Test	Pattern
OTN BERT - framed ^a	PRBS9, PRBS15, PRBS20, PRBS23, PRBS31 (default), Null Client, and User Pattern.
OTN BERT - unframed	PRBS9, PRBS11^b, PRBS15, PRBS20^b, PRBS23, PRBS31 (default), Square Wave 1 zero/one^c, Square Wave 2 zeros/ones^c, Square Wave 4 zeros/ones^c, Square Wave 8 zeros/ones^c, and Square Wave 16 zeros/ones^c.
OTN-SONET/SDH BERT, SONET/SDH BERT	PRBS9, PRBS11, PRBS15, PRBS20, PRBS23, PRBS31, 1111, 1100, 1010, 0000, 1in8, 1in16, 2in8, and User Pattern.
EtherBERT - unframed	PRBS9, PRBS11^d, PRBS15, PRBS20^d, PRBS23, PRBS31 (default),

- Only **PRBS31** is available with ODU0/1/2/3 multiplex in OTU4.
- Not available with OTU4 - 4 **Unframed Physical Lanes**.
- Square Wave patterns are only available when the **All Lanes** check box is selected. Not available with **20 Unframed Physical Lanes** and OTU4 - 4 **Unframed Physical Lanes**.
- Not available with 100GE - 4 **Unframed CAUI-4**.

DSn/PDH Interfaces:

Pattern	DS0, E0	DS1	DS3, E1	E3, E4
0000, 1010, 1100, 1111, 1in8, 1in16, 2in8	X	X	X	X
3in24	X	X	X	X (E3 only)
T1 DALY, 55 OCTET, Multi-Pattern	-	X	-	-
PRBS9	X	X	X	X
PRBS11	X ^a	X	X	X
PRBS15		X	X ^a	X
PRBS20, User Pattern	X	X	X	X
PRBS23	-	X	X	X ^a
PRBS31	-	X	X	X
QRSS	-	X ^a	-	-
Null Client	-	-	-	-

- Default value.

For Multi-Pattern, see *Multi-Pattern Configuration* on page 144.

When **User Pattern** is selected, enter the payload pattern hexadecimal value.

- **Invert** check box, when selected (cleared by default), inverts the test pattern meaning that every 0 will be changed for 1 and every 1 for 0. For example, the pattern 1100 will be sent as 0011. Not available when pattern is Multi-Pattern.
- **All Lanes** check box is available with an unframed test with parallel interface. When selected, it allows setting the same TX and/or RX test pattern for all lanes. When **All Lanes** check box is cleared (default), a different test pattern may be set for each lane.

When the **All Lanes** check box is cleared, for an unframed test, the following pattern settings are available for each lane.

- **TX Pattern/RX Pattern:** Select the test pattern from the list (see page 140) for each lane and direction (TX and RX).
- **Invert** check box, when selected (cleared by default), inverts the test pattern meaning that every 0 will be changed for 1 and every 1 for 0. For example, the pattern 1100 will be sent as 0011.
- **Pattern Sync** icon indicates the status of the received signal pattern. Refer to *Status Bar* on page 28 for more information.

Test Setup - Test Configurator, Timer, and System

BERT and Unframed BERT

Bit Error

- **Pass/Fail Verdict** allows enabling bit-error-rate pass/fail verdict by selecting either **Bit Error Count** or **Bit Error Rate**. The default value is **Disabled**.
- **BER Threshold** allows entering the threshold **Count** or **Rate** value that will be used to declare the pass/fail verdict. The **BER Threshold** applies to individual pattern for **Multi-Pattern**.

For **Count**, enter the maximum bit error count allowed before declaring a fail verdict: **0** (default) to **999999**.

For **Rate**, enter the maximum bit error rate allowed before declaring a fail verdict: **1.0E-14** to **1.9E-01**. The default value is **1.0E-12**.

Service Disruption

The Service Disruption Time (SDT) corresponds to the duration associated to a defect that occurred in the network. For example a disruption that occurs during a network switching from the active channels to the backup channels or vice versa.

Note: *The service disruption measurements are cleared when changing the criteria. Service Disruption is not available for **Multi-Pattern**.*

- **Defect** allows choosing on which layer and defect the service disruption time test will be performed. Choices depend on the selected test path.

Layer	Defect
Interface	OTN/SONET/SDH: LOS ^a DSn: LOS, BPV, EXZ PDH: LOS, CV
Section/RS	LOF-S/RS-LOF, B1
Line/MS	AIS-L/MS-AIS, RDI-L/MS-RDI, REI-L/MS-REI, B2

Layer	Defect
STS/AU Path	AIS-P/AU-AIS, LOP-P/AU-LOP, RDI-P/HP-RDI, REI-P/HP-REI, B3, UNEQ-P/HP-UNEQ, PDI-P (SONET)
VT/TU Path	AIS-V/TU-AIS, LOP-V/TU-LOP, UNEQ-V/LP-UNEQ, RDI-V/LP-RDI, REI-V/LP-REI, BIP-2
DS1	AIS, OOF, RAI, Framing Bit, CRC-6
DS3	AIS, OOF, Idle, RDI, F-Bit, C-Bit, P-Bit, FEBE
E1	AIS, CRC-4, E-Bit, LOMF, TS16 AIS, LOF, FAS, RAI, RAI MF
E4, E3, E2	AIS, LOF, FAS, RAI
OTL ^b	LOF, OOF, LOL, LOR, OOR, Inv. Marker, FAS
FEC	FEC CORR, FEC UNCORR
OTUk ^c	AIS, LOF, OOF, LOM, OOM, BDI, IAE, BIAE, BIP-8, BEI, FAS, MFAS
ODUk ^c	AIS, OCI, LCK, BDI, BIP-8, BEI, FSF, BSF, FSD, BSD
OPUk ^c	AIS, CSF, PLM ^d , MSIM ^e , LOOMFI ^{ef} , OOMFI ^{ef} , OMF ^{ef}
BER ^g	Pattern Loss, Bit Error (default)

- a. Not available with QSFP transceivers.
- b. The service disruption time measurement is available per lane for OTL defects at the exception of LOL which is global for all lanes. Refer to *OTL-SDT* on page 437 for results per lanes.
- c. Only available on the top layer.
- d. Available when the PLM check box is selected (refer to page 180 for more information).
- e. Available with multiplex test only.
- f. Available with OPU4 only.
- g. Available when the **No Pattern Analysis (Live)** check box (see page 139) is cleared.

Note: *The Service Disruption Time measurement supports a parent defect approach where the SDT measurement is triggered when the selected defect or a higher defect in the signal structure hierarchy is detected. For example, if Bit Error is selected, an OPU AIS error will trigger an SDT event.*

- **No Defect Time (ms)** represents the period without any defects before stopping SDT measurement: **0.005 ms** to **2000 ms** (default is **300 ms**).
- **Disruption Monitoring** check box when selected (disabled by default) enables the disruption time measurements. However, the measurement will only start if the test is already started, or when the test will be started.

Test Setup - Test Configurator, Timer, and System

BERT and Unframed BERT

Note: Clearing the **Disruption Monitoring** check box will stop the measurement without clearing the results. The disruption monitoring is automatically stopped without clearing results when the test is stopped. However, starting the test again while the **Disruption Monitoring** check box is selected will reset the results before restarting.

- **Pass/Fail Verdict** check box when selected (cleared by default) enables service disruption pass/fail verdict and allows setting the threshold value.
- **SDT Threshold (ms)** allows entering the SDT threshold value that will be used to declare the pass/fail verdict: **0.001 to 299999.999 ms** (default is **50 ms**). For EtherBERT, the minimum value is adjusted with respect to the **No Traffic Time**.

Multi-Pattern Configuration

Note: Only available for **DSN/PDH BERT** test application with **DS1** signal (**DS0** disabled) and when the pattern is **Multi-Pattern**.

This feature allows sending each pattern for a specific duration, sequentially and continuously.

- **Pattern** represents a sequence of patterns that will be generated: **1111**, **1in8**, **2in8**, **3in24**, and **QRSS**.
- **Enable** allows enabling the generation of each pattern individually in the pattern sequence. All patterns are enabled by default. All 1's (1111) is disabled for **Unframed** test.
- **Individual Pattern Duration** specifies the transmission duration of each pattern: **15 s**, **30 s**, **45 s**, **1 min**, **2 min**, **3 min** (default),... up to **15 min**.

Restore < Test Application > Defaults

Reverts the current test application to its default factory settings.

Cable Test

From the **Test** menu, tap **Setup**, **Test Configurator**, and the test block.

Global Options

- **Wiring Standard** is the pin-to-pair assignment corresponding to the UTP cable used: **T568A** (default) or **T568B**.

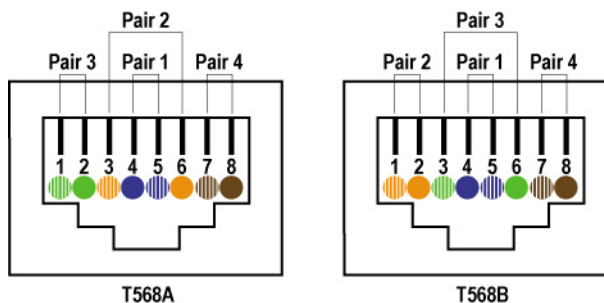

- **Length Unit** is the unit used for cable length and distance to fault results: **Meter** (default) or **Feet**.
- **PoE** check box when selected (cleared by default) allows verifying that the Power Sourcing Equipment (PSE) is capable to deliver appropriate power (PoE) to the Powered Device (PD). The PoE test is performed after the cable test is executed confirming that the cable is ready to carry data and power: either the Wire Map test reported **No fault**, **Straight pair**, **Crossed Pair**, or **Noise (link up)**. Only available on 8870/8880.

Test Setup - Test Configurator, Timer, and System

Cable Test

- **Power Class**, available when PoE is enabled, selects the power class of the simulated powered device:

Power Class	Power Device
Class 0 (13.0W) - (default)	Type 1
Class 1 (3.8W)	
Class 2 (6.5W)	
Class 3 (13.0W)	
Class 4 (25.5W)	Type 2

Pass/Fail Verdict

- **Pass/Fail Verdict** check box when selected (default) enables the cable test pass/fail verdict and allows setting the threshold values.
 - **Prop. Delay Threshold (ns)** is the maximum time for a pulse to reach the far end: **0** to **1000** ns (default is **1000** ns for 10 Mbit/s, **556** ns for 100 Mbit/s, and **570** ns for 1 Gbit/s).
 - **Delay Skew Threshold (ns)** is the maximum time between the fastest and slowest pairs of a 1000 Base-T signal: **0** to **120** ns (default is **50** ns).
 - **Length Threshold (m)** is the maximum acceptable cable length: **0** to **120** m (0 to 394 feet) (default is **100** m (328 ft)).
 - **PoE Loaded Voltage Thresholds (V)**, available when the **PoE** check box is selected, allows the configuration of the acceptable voltage range when a load is applied: minimum value is either **37** (default) for Class 0 to 3 or **42.5** (default) for Class 4; maximum value is 57 (default). A Pass verdict is declared when the measured voltage is within the defined range.

Restore Cable Test Defaults

Reverts the configured parameters to their default values.

CFP4/CFP8/QSFP/SFP/SFP+/SFP28

This tab gives hardware information related to the inserted transceiver module.

From the **Test** menu, tap **Setup, Test Configurator**, tap on the interface block or on the **Local** block for iSAM, and on the CFP4/CFP8/QSFP/SFP/SFP+/SFP28 tab.

Clock

Allows the configuration of the clock synchronization.

From the **Test** menu, tap **Setup**, **Test Configurator**, and tap on the clock block.

Clock Synchronization

Clock Mode allows selecting the source clock that will be used for transmission (TX).

- **Internal:** Internal clock of the unit (STRATUM 3). The clock mode is forced to **Internal** for Multi-Channel OTN.
- **Recovered:** Line clock from the input port signal involved in the test. Available with Transport test applications, CPRI/OBSAI RRH, and Ethernet applications using 10G WAN. The clock mode is forced to **Recovered** for 1GE electrical interface using **Slave** local clock (see **Local Clock** on page 185).
- **External:** Clock signal from the EXT CLK port.
- **Backplane:** Clock from another module on the platform (only supported on FTB-2 and FTB-2 Pro platforms). The other module must support the backplane clock feature and must be enabled. Not available when the **Backplane Clock** check box is selected (see page 153). The Backplane clock cannot be shared between FTB- and FTBx- modules.

Note: *For CPRI/OBSAI Base Station single port topology, the clock is configurable to **Internal** or **External**; for CPRI/OBSAI Remote Radio Head, the clock is fixed to **Recovered**; for CPRI dual port topology, the clock block is not displayed and the clock mode is automatically set to **Internal** for the Base Station and **Recovered** for the Remote Radio Head.*

Ext Clock In

Note: Available when the **Clock Mode** is set to **External**.

Allows setting the external clock for test synchronization.

- **Interface Type** allows the selection of the clock interface: **DS1** (default), **E1, 2MHz** (default when DS1 is not supported), or **1PPS**. **1PPS** is automatically selected for **Dual Test Set in One-Way Latency** measurement mode.

Ext Clock In on a green background indicates that a valid clock is received.

LOS on a red background indicates that the received clock is not valid.

- **Connector**, available on 8870/8880, either indicates that the BNC connector type is used for the clock or on 8880 allows the selection of **Bantam** or **RJ48C** when the BNC connector is used by the test application. The module connector blue LED used for Ext Clock In is flashing.
- **Termination** mode specifies how the module is connected to the synchronization signal. The **Termination** mode is set to **TERM** for 2MHz and configurable for DS1 and E1.

For DS1:

- **TERM** provides an input that terminates the DS1 signal.
- **DSX-MON** provides high-input impedance and compensation for resistive loss. This setting is useful for monitoring DS1 signals at DSX monitor points, which are resistor-isolated.
- **BRIDGE** provides high-input impedance for bridging lines that are already terminated. This setting is useful for bridging directly across copper cable pairs.

Test Setup - Test Configurator, Timer, and System

Clock

For E1:

- **TERM** provides an input that terminates the E1 signal.
- **MON** provides high-input impedance and compensation for resistive loss. This setting is useful for monitoring E1 signals at monitor points, which are resistor-isolated.
- **BRIDGE** provides high-input impedance for bridging lines that are already terminated. This setting is useful for bridging directly across copper cable pairs.
- **Line Coding** allows the selection of the interface line coding.

For DS1: **AMI** and **B8ZS** (default).

For E1: **AMI** and **HDB3** (default).

- **Framing:** Allows the selection of the interface framing.

For DS1: **SF**, **SLC-96**, and **ESF** (default).

For E1: **PCM30** (default), **PCM30 CRC-4**, **PCM31**, and **PCM31 CRC-4**.

- **Frequency (MHz)** displays the frequency of the received signal rate.
- **Offset (ppm)** displays the positive or negative frequency offset between the standard rate specification and the rate from the received signal. The background color is used to indicate if the received clock meets (green) or not (red) the standard rate specification.

Signal	Standard Rate specification
DS1	1544000 ± 8 bit/s (± 4.6 ppm)
E1	2048000 ± 10 bit/s (± 4.6 ppm)
2MHz	2048000 ± 10 bit/s (± 4.6 ppm)

Ext Clock Out

Note: Available when the **Clock Mode** is set to **Internal**, **Recovered**, or **Backplane**. Not available on 8870.

Allows setting the clock that will be generated.

- **Interface Type** allows the selection of the clock interface: **None** (default when DS1 is not supported), **DS1** (default), **E1**, and **2MHz**.
Ext Clock Out on a green background indicates that a valid clock is generated on the clock port.
LOC on a red background indicates that no clock is generated on the clock port.
- **Connector**, available on 8870/8880, either indicates that the BNC connector type is used for the clock or on 8880 allows the selection of **Bantam** or **RJ48C** when the BNC connector is used by the test application.
- **LBO** (Line Build Out), available with DS1 only, allows the selection of the interface Line Build Out that meets the interface requirements over the full range of cable lengths: **DSX-1 (0-133 ft)** (default), **DSX-1 (133-266 ft)**, **DSX-1 (266-399 ft)**, **DSX-1 (399-533 ft)**, and **DSX-1 (533-655 ft)**.
- **Line Coding**, available with DS1 and E1, allows the selection of the interface line coding.
For DS1: **AMI** and **B8ZS** (default).
For E1: **AMI** and **HDB3** (default).
- **Framing**, available with DS1 and E1, allows the selection of the interface framing.
For DS1: **SF**, **SLC-96**, and **ESF** (default).
For E1: **PCM30** (default), **PCM30 CRC-4**, **PCM31**, and **PCM31 CRC-4**.

REF OUT

Source, available with CFP4 and QSFP28 transceivers, allows selecting the source clock that will be used for transmission (TX) on the **REF OUT** port: **TX MCLK** (default for CFP4), **Internal 1/8**, **Internal 1/40**, **Internal 1/160** (default for QSFP28). **TX MCLK** is a clock derived from the inserted transceiver and its frequency is based on the setting of the *CFP4/CFP8 Reference Clock (MHz)* on page 133.

Frequency (MHz) displays the frequency of the clock generated on the **REF OUT** port based on the test interface rate¹ and divider ratio as follows:

Interface/Rate	Divider Ratio			
	1/8 ^a	1/16	1/40 ^a	1/160 ^a
OC-192 STM-64 10G WAN	-	622.08 MHz	-	-
10G LAN 40GE	-	644.5313 MHz	-	-
OTU2	-	669.3266 MHz	-	-
OTU1e	-	690.5692 MHz	-	-
OTU2e	-	693.4813 MHz	-	-
OTU1f	-	704.3806 MHz	-	-
OTU2f	-	707.3527 MHz	-	-
OTU3	-	672.1627 MHz	-	-
OTU3e1	-	696.4214 MHz	-	-
OTU3e2	-	696.6149 MHz	-	-
OTU4	3494.1 MHz	-	698.8123 MHz	174.7031 MHz
100GE	3222.6 MHz	-	644.5313 MHz	161.1328 MHz

- a. Only available with CFP4 and QSFP28 transceivers.

1. For parallel interfaces, the REF OUT signal is derived from the interface lane rate.

Clock Out indicates the status of the clock generated on the **REF OUT** port as follows:

- Green: a valid clock is generated.
- Red: the clock is either not available (--) then not generated, or not valid but generated.

Note: *The Ref Out clock port provides an eye diagram timing reference for 10G and above optical devices. This clock is provided for basic assessment. Formal qualification may require specialized external circuitry.*

Backplane

Note: *Only supported on FTB-2 and FTB-2 Pro platforms when the **Clock Mode** is set to **External, Recovered, or Internal**.*

Backplane Clock check box when selected (cleared by default) makes available the source clock (**Clock Synchronization - Clock Mode**) to other modules on the platform. Other modules on the platform need to set the **Clock Mode** as **Backplane** to use this clock. The **Backplane Clock** should be only enabled on one module on the same platform. The Backplane clock cannot be shared between FTB- and FTBx- modules.

Backplane indicates that the background clock is generated (green) or disabled (gray).

LOC on a red background indicates, when the backplane clock is enabled, that the synchronization is not possible with the selected reference clock.

Tributary Synchronization

Note: Only available with SONET/SDH - DS_n/PDH and DS_n/PDH test applications on 8870/8880 module. Not supported in Through topology.

Clock Mode allows selecting the source clock that will be used for tributary transmission (TX); default is **Internal**. The availability of clock modes is as follows:

Clock Synchronization	Tributary Synchronization
Internal	Internal
Recovered	Internal Recovered
External	Internal External
Backplane	Internal Backplane

- **Internal:** Internal clock of the unit (STRATUM 3).
- **Recovered:** Line clock from the input port signal involved in the test.
- **External:** Clock signal from the EXT CLK port.
- **Backplane:** Clock from another module on the platform (only supported on FTB-2 and FTB-2 Pro platforms). The other module must support the backplane clock feature and must be enabled. The Backplane clock cannot be shared between FTB- and FTBx-modules.

EtherBERT, FC BERT, BERT (CPRI/OBSAI), and Unframed BERT

Note: For EtherBERT unframed test 40GE or 100GE, refer to BERT and Unframed BERT on page 139.

From the **Test** menu, tap **Setup, Test Configurator** and tap on the **EtherBERT, FC BERT, BERT, or Unframed BERT** block.

LINK

Note: Available with OTN BERT test application with Ethernet client (EoOTN).

A green/red arrow is used to indicate the status of the link at the PCS level:

- A green arrow indicates that the link is up.
- A red arrow indicates alarms at the PCS level, the link is down.

The **Local Fault Detected, Local Fault Received, Remote Fault, LOA (OTU4), Hi-BER (OTU4), LOBL1027B (OTU3), Hi-BER1027B (OTU3), and LOAML1027B (OTU3)** alarms are displayed. Refer to *Ethernet* on page 359, *Ethernet - PCS Lanes* on page 364, and *Transcoding* on page 405 for more information.

Restore < Test Application > Defaults

Reverts the current test application to its default factory settings. Only available with OTN BERT test application with Ethernet client (EoOTN).

Pattern

- **Coupled RX to TX** check box, when selected (default), couples both the TX and RX signal with the same test pattern. The **Coupled RX to TX** check box is selected and not configurable for **Seed A, Seed B, and PRBS31 Unscrambled** patterns as well as for CPRI/OBSAI BERT test.

Test Setup - Test Configurator, Timer, and System

EtherBERT, FC BERT, BERT (CPRI/OBSAI), and Unframed BERT

- **No Pattern Analysis (Live)** check box when cleared (default; selected by default for framed CPRI), monitors the incoming traffic pattern and Round-Trip Latency. For live traffic, the **No Pattern Analysis (Live)** check box should be selected as the traffic is a live pattern and in this case no monitoring is required. Even if this check box is not available for FC BERT, the received traffic pattern and Round-Trip Latency are monitored. See *BER* on page 350 for more information.
- **TX Pattern/RX Pattern:** Select the test pattern from the list for each direction (TX and RX) if required. Choices are **PRBS9, PRBS11, PRBS15, PRBS20, PRBS23, PRBS31** (default), **Seed A¹, Seed B¹, PRBS31 Unscrambled¹, CSPAT², CJTPAT², CRPAT², Short CRTPAT², Long CRTPAT², and User Pattern**. Pattern is not configurable and set to **PRBS31** for 40/100GE dual port topology, and for 400GE test.

When **User Pattern** is selected, enter the payload pattern hexadecimal value.

- **Invert** check box, when selected (cleared by default), inverts the generated/expected test pattern meaning that every 0 will be changed for 1 and every 1 for 0. For example, the pattern 1100 will be sent as 0011.

Bit/Pattern Error

The configuration of **Bit Error** is available with all patterns at the exception of **Seed A** and **Seed B** for which **Pattern Error** is available.

- **Pass/Fail Verdict** allows enabling and configuring bit/pattern error rate/count threshold prior to run the test. This allows for a simple pass/fail verdict, leaving no room for misinterpretation of the test results. To enable the pass/fail verdict, select either **Bit/Pattern Error Count** or **Bit/Pattern Error Rate** (default is **Disabled**).

1. Only available for 10G LAN with **Unframed (Interop)** (see Framing on page 122).

2. Only available for 1G optical with **Framed Layer 1** (see Framing on page 122).

Test Setup - Test Configurator, Timer, and System

EtherBERT, FC BERT, BERT (CPRI/OBSAI), and Unframed BERT

- **BER Threshold** allows entering the threshold **Count** or **Rate** value that will be used to declare the pass/fail verdict.

For **Count**, enter the maximum bit/pattern error count allowed before declaring a fail verdict: **0** (default) to **999999**.

For **Rate**, enter the maximum bit/pattern error rate allowed before declaring a fail verdict: **1.0E-14** to **1.9E-01**. The default value is **1.0E-12**; **2.1E-5** for **CLR4** unframed; **5.0E-5** for **SR4, CWDM4, and Other** unframed.

CPRI/OBSAI

Note: *Available with CPRI/OBSAI BERT test application with Framed L2.*

Pass/Fail Verdict check box when selected (default) enables the pass/fail verdict. A pass verdict is given when the link status is up and no CPRI/OBSAI alarm and/or error are recorded for the duration of the test.

Test Setup - Test Configurator, Timer, and System

EtherBERT, FC BERT, BERT (CPRI/OBSAI), and Unframed BERT

Restore CPRI/OBSAI Defaults

Note: *Available with CPRI/OBSAI BERT test application.*

Reverts the current test application to its default factory settings.

Service Disruption

Note: *Not available for FC BERT.*

- **No Traffic Time** (ms) represents the time between two Ethernet Frames that is acceptable without raising an alarm including a Service Disruption event: **0.005 ms to 1000 ms** in step of 0.005 ms (default is **50 ms**). Only available with EtherBERT.
- **No Defect Time (ms)** represents the period without any defects before stopping SDT measurement: **0.005 ms to 2000 ms** (default is **300 ms**). Only available with CPRI/OBSAI.
- **Disruption Monitoring** check box when selected (disabled by default) enables the disruption time measurements. However, the measurement will only start if the test is already started, or when the test will be started.

Note: *Clearing the **Disruption Monitoring** check box will stop the measurement without clearing the results. The disruption monitoring is automatically stopped without clearing results when the test is stopped. However, starting the test again while the **Disruption Monitoring** check box is selected will reset the results before restarting.*

- **Pass/Fail Verdict** allows enabling and configuring the SDT Threshold.
- **SDT Threshold** allows configuring the amount of time with no traffic that is accepted before failing the test: **0.005 to 299999.995 ms** in step of 0.005 ms (default is **50 ms**). For EtherBERT, the threshold value cannot be less than the **No Traffic Time** value.

FC Frame

Note: *Only available with FC BERT.*

Frame Size (Bytes) allows entering the frame size (in step of 4 bytes) for FC BERT test application: **40** to **2148** bytes (default). However the minimum frame size is 64 bytes when the **Latency Tag** check box is selected.

Latency Tag Insertion

Note: *Only available with FC BERT.*

Round trip latency measures the average round trip latency (delay) between the time the data was transmitted and received.

- **Latency Tag** check box when selected enables latency measurements.
- **Pass/Fail Verdict** check box when selected enables the pass/fail verdict and allows setting the **Round-Trip Latency Threshold**.
- **Round-Trip Latency Threshold (ms)** allows the selection of the round trip latency: **0.015** (default) to **8000 ms**.

Test Setup - Test Configurator, Timer, and System

EtherBERT, FC BERT, BERT (CPRI/OBSAI), and Unframed BERT

Shaping

- **TX Rate** allows the selection of the transmission rate in percentage of utilization (100 percent by default), Mbit/s, Gbit/s, Frame/s, or IFG for Ethernet; Mbit/s, Gbit/s, MB/s, or % for Fibre Channel. For Ethernet, the maximum percentage is 105 percent depending on the frame size selected.
- **Enable TX** check box is automatically selected when starting the test allowing stream/client generation. The **Enable TX** check box may also be selected or cleared while the test is running. Not available for FC BERT.

Ethernet Frame

Frame Size (Bytes) allows entering the frame size for Ethernet test applications. The range is from **64**¹ to **16000**².

The following table lists each component that may affect the minimum frame size values.

Component	Description
VLAN	4 bytes per VLAN (up to 3 VLAN for EtherBERT test application and only 1 VLAN for EoOTN client)
EoE Header	16 bytes
EoE VLAN	4 bytes
PBB-TE Header	18 bytes
B-VLAN	4 bytes
UDP	8 bytes
TCP	20 bytes
Ethernet Header	14 bytes
LLC and SNAP Headers	8 bytes
IPv4	20 bytes
IPv6	40 bytes

Note: *Sending traffic with frame size > 1518 in switched network may result in losing all frames.*

-
1. The minimum frame size will be adjusted according to the frame structure and components selected.
 2. The maximum frame size is limited to 10000 for 10/100/1000Mbps electrical interface.

Test Setup - Test Configurator, Timer, and System

EtherBERT, FC BERT, BERT (CPRI/OBSAI), and Unframed BERT

Note: *The following frame parameters are only available for OTN BERT test application with Ethernet client (EoOTN).*

- **Source MAC Address** is the module default and unique Source Media Access Control (MAC) address that is automatically given to the stream. Tap the **Source MAC Address** field if the stream MAC address has to be changed and enter the new MAC address.
- **Destination MAC Address** is the destination MAC address for the stream. The default setting is the MAC address of the port. Tap the **Destination MAC Address** field if the stream MAC address has to be changed and enter the new MAC address.
- **VLAN ID** check box, when selected (cleared by default), allows the configuration of the following VLAN parameters. Selecting the VLAN check box affects the **Frame Size** value.
 - **VLAN ID** sets the VLAN ID. Choices are **0** through **4095** (default is **2**). Refer to *VLAN ID and Priority* on page 758 for more information.
 - **Priority** sets the VLAN user priority. Choices are **0** (default) to **7**. Refer to *VLAN ID and Priority* on page 758 for more information.
 - **Type** indicates the supported VLAN Ethernet type which is **0x8100**.

EtherSAM - Burst

Note: The **Burst** settings are only available for configuration when the **Burst Test** check box is selected (see page 165).

From the **Test** menu, tap **Setup**, **Test Configurator**, tap on the test block, and on the **Burst** tab.

Note: The burst configuration parameters are defined globally for all services but **CBS**, **EBS**, and **Burst Max Rate** parameters are as per each service configuration.

Burst Sequence

The graphic illustrates the configured burst sequence that contains in order, from left to right:

- **Refill Delay** represents the pre-burst recuperation time in percentage that is equal to the remaining percentage not used by the post-burst time (**Refill Delay Ratio**).
- **Burst Frames** represents the burst frame ratio in percentage that is equal to the subtraction of **100 % - Burst/IR Frame Ratio**.
- **Refill Delay** represents the post-burst recuperation time in percentage that is equal to the configured **Refill Delay Ratio**.
- **CIR or CIR+EIR Frames** represents the percentage of transmission at CIR or CIR+EIR rate. The **CIR or CIR+EIR Frames** percentage is equal to the configured **Burst/IR Frame Ratio**.
- The “. . .” next to the burst sequence indicates that the burst sequence is repeated the number of times specified in the **Number of Burst Sequence** field.

Parameters

- **Number of Burst Sequence** is the number of times, **1** to **100** (default is **2**), the burst sequence will be repeated for the CBS and EBS tests.
- **Refill Delay Ratio (%)** is the percentage of time required to refill the CBS/EBS token buckets. The refill delay ratio is used for post-burst delay and the remaining percentage is applied to the pre-burst delay. The **Refill Delay Ratio** is configurable from **0** to **100** percent (**50** percent is the default as well as the standard's minimum recommended value).
- **Burst/IR Frame Ratio (%)** is the percentage of frames transmitted at CIR rate for the CBS test and the percentage of frames transmitted at CIR+EIR rate for the EBS test. The **Burst/IR Frame Ratio** is configurable from **10** to **90** percent (**90** percent is the default as well as the standard's recommended percentage value).

Table

Note: *Test time values are only displayed for enabled services.*

- **Service No** indicates the service number.
- **Service Name** indicates the name of the service.
- **Direction**, available with **Dual Test Set** or **Dual Port** topology, indicates respectively results from local to remote (**L->R**) and remote to local (**R->L**), or P1 to P2 (**P1->P2**) and P2 to P1 (**P2->P1**).
- **CBS Test Time (s)** indicates the total time required to perform all burst sequence iterations of the CBS test for this service.
- **EBS Test Time (s)** indicates the total time required to perform all burst sequence iterations of the EBS test for this service.
- **Total Burst Test Time (s)** indicates the total time required to perform all burst sequence iterations of both CBS and EBS tests for this service.

EtherSAM - Global

From the **Test** menu, tap **Setup, Test Configurator**, tap on the test block, and on the **Global** tab.

Dual Test Set

- **Dual Test Set (DTS)** check box when selected (cleared by default) enables EtherSAM **Dual Test Set**. Once **Dual Test Set** is enabled, use the **Discover Remote** button to select a remote unit. Not available in **Dual Port** topology.

Note: *It is also possible using the Discover Remote button to connect to a remote module and automatically enable Dual Test Set. For more details, refer to Discover Remote Button on page 636.*

- **Disconnected** indicates that there is no connection established with a remote module.
- **NAT LAN/WAN** and **WAN IP** indicate presence of NAT (Network Address Translation) router. The NAT router is automatically detected and graphically displayed with LAN/WAN indication as well as the WAN IP address when the module is behind a NAT router.

Note: *When there is a NAT at the Remote site, it is required to create UDP/TCP port 62819 forwarding rule on this NAT router to allow DTS communication. In addition, when there is a NAT in both directions (L->R and R->L), it is also required to create port forwarding rules on the NAT router located at the Remote side for every service defined.*

- **Discover Remote** button allows discovering remote modules supporting **Remote Loopback** and/or **Dual Test Set**. For more details, see *Discover Remote Button* on page 636.

Subtests

- **Service Configuration Test** verifies if the network configuration is correct for each service before starting a long term test (Service Configuration Test). To test the network configuration, a ramp test and/or a burst tests is/are generated for each configured service.
- **Seconds per Service** indicates the **Service Configuration Test** duration in seconds based on the configured Services, Ramp, and Burst settings.
- **Ramp Test** check box when selected (default):

In the first stage of the test, when **CIR** check box is selected (see *SLA Parameters* on page 285), the throughput is increased incrementally in steps until the CIR level is reached. During the first stage, the maximum Jitter, Latency, Frame Loss, and throughput are measured and are compared to the SLA thresholds to declare a pass/fail verdict.

In the second stage of the test, when the **CIR+EIR** check box is selected (see *SLA Parameters* on page 285), the throughput is increased to the **CIR+EIR** level to compare against expected maximum throughput threshold to declare a pass/fail verdict.

In the third stage of the test, when the **Traffic Policing** check box is selected (see *Test Parameters* on page 284), the throughput is increased one step over the **CIR+EIR** if selected otherwise over the **CIR** to compare against expected maximum throughput threshold to declare a pass/fail verdict.

The ramp test procedure is generated for each enabled service.

- **Burst Test** check box when selected (cleared by default) verifies that the expected burst size can be transmitted at maximum burst rate with minimal loss.

CBS (Committed Burst Size) check box when selected (see *SLA Parameters* on page 285), verifies the performance of a committed burst size at **CIR**'s average **TX** rate.

EBS (Excess Burst Size) check box when selected (see *SLA Parameters* on page 285), verifies the performance of an excess burst size at **CIR+EIR**'s average **TX** rate.

The maximum Jitter, Latency, Frame Loss, and throughput are measured. For **CBS**, the Jitter, Latency, and Frame Loss are compared to the SLA thresholds to declare a pass/fail verdict. For **EBS**, the throughput is compared to the SLA thresholds to declare a pass/fail verdict.

The burst test procedure is generated for each enabled service.

- **Service Performance Test** check box when selected (default) verifies that the **SLA** parameters (see *SLA Parameters* on page 285) are met over time by running multiple services simultaneously. The maximum Jitter, Latency, Frame Loss, and average throughput are measured and compared to the configured thresholds to declare pass/fail verdicts. The **Service Performance Test** is only performed for services that have their **CIR** check box selected.

Subtest Duration allows setting the duration time, in HH:MM:SS format, for the **Service Performance Test** (default is 10 minutes).

- **Global Test Duration Estimate** indicates the total estimate duration of the test.

Global Options

- **Per Direction Configuration** check box when selected (default) specifies that the values can be configured independently for each direction (local to remote and remote to local) for **Dual Test Set** or for each port (P1 to P2 and P2 to P1) for **Dual Port**; for **Dual Port** using a different rate on each port, the check box is forced selected. When the **Per Direction Configuration** check box is cleared the configuration will be coupled and the values apply to both directions/ports.

Note: For *Dual Test Set* the **Per Direction Configuration** is only available when the communication with the remote module is established.

- **Pass/Fail Verdict** check box when selected (default) enables the pass/fail verdict. A global pass/fail verdict is given for the EtherSAM test, **Service Configuration**, and **Service performance** (for each service). The pass/fail verdict is based on the following criteria: **Frame Loss**, **Max Jitter**, **Round-Trip Latency**, and **Average RX Rate**.
- **Latency Measurement Mode**, available with **Dual Test Set** for rates from 10M to 10GE, allows the selection of the latency measurement mode: **Round-Trip** (default) or **One-Way**.

Synchronization with an external 1PPS clock is required to perform One-Way Latency measurement. One-Way Latency is only possible when both local and remote 1PPS signal clocks are valid. The following alarms are available with One-Way Latency measurement.

LOPPS-L and **LOPPS-R** (Loss Of Pulse Per Second - Local/Remote) are declared when either no pulse is received or when no pulse is received within 1 second $\pm 6.6 \mu\text{s}$ after the previous pulse. LOPPS-R is only monitored once the DTS connection is established.

Restore EtherSAM Defaults

Reverts the current test application to its default factory settings.

EtherSAM - Ramp

Note: The **Ramp** tab is only available for configuration when the **Ramp Test** check box is selected (see page 165).

From the **Test** menu, tap **Setup**, **Test Configurator**, tap on the test block, and on the **Ramp** tab.

Note: The ramp configuration parameters are defined globally for all services but the presence of CIR+EIR, and Traffic Policing steps are as per each service configuration. CIR, CIR+EIR, and Traffic Policing steps are part of the step list as soon as they are enabled for at least one service even if that service is not enabled.

Dynamic Ramp

The graphic displays the percentage of each CIR level step in time.

Step Time

The step time is the test duration for each ramp step: **5** (default) to **60** seconds.

Ramp Duration

The ramp duration indicates the total time required to perform all the ramp steps for each service.

Add Step

Allows adding a new ramp step. Enter the CIR percentage from **1** to **99**. A maximum of 7 pre CIR steps can be added in the ramp configuration.

Delete Step

Allows deleting a step from the ramp. Select the step from the list and tap on **Delete**.

Defaults

Reverts the ramp configuration to its default factory settings.

External Reference

Allows the configuration of the external reference signal. Available with Wander test application.

From the **Test** menu, tap **Setup**, **Test Configurator**, and tap on the **External Reference** block.

Reference

Mode is set to **External Reference**.

Ext Reference In

Allow the selection of the reference signal for TE/TIE measurements.

- **Signal** allows the selection of the reference interface: **2 MHz**, **10 MHz**, and **1PPS**. Only **1PPS** reference is available for 1PPS interface/rate test.

Ext Ref In on a green background indicates that a valid reference is received.

LOS on a red background indicates that the received signal is not valid.

- **Connector** indicates the connector used for the external reference signal: **RJ48C** or **BNC**.
- **Frequency (MHz)** displays the frequency of the received reference signal.

Fibre Channel

From the **Test** menu, tap **Setup, Test Configurator**, and the **Fibre Channel** block.

World Wide Name (WWN)

The following WWN settings are only available when the **Login - Enable** check box is selected (see page 173).

- **Source** allows setting the 64-bit WWN address of the local fibre channel port: **00-00-00-00-00-00-00-00** to **FF-FF-FF-FF-FF-FF-FF-FF** (default is **20-00-00-03-01**[IEEE-MAC lsb (bits 23..0)]).
- **Destination** allows setting the 64-bit WWN address of the remote fibre channel port: **00-00-00-00-00-00-00-00** (default) to **FF-FF-FF-FF-FF-FF-FF-FF**. The destination WWN address is displayed and grayed-out for Point-to-Point topology after a successful login.

Buffer to Buffer Flow Control

Buffer to Buffer (BB) Flow Control, also called Flow Control Management, manages the control of data traffic between the local and remote fibre channel ports based on the network, distance, and traffic congestion.

Each remote port advertises the buffer size (**BB_Credit**) during the login.

- **Enable** check box when selected allows setting or use buffers to receive frames. The **Enable** check box is force selected when the **Login - Enable** check box is selected (see page 173).
- **Available BB_Credit** is the number of frame buffers that the remote port has available to receive frames from the local port: **1 to 65535** (default is **10**). The **Available BB_Credit** is not editable when the **Login - Enable** check box is selected but its value received from the remote interface through the login process is displayed. If the login fails, the **Available BB_Credit** displays “-”.

Login

After a link is established, it is possible to login to the Fibre Channel Network to send and receive data between a local and remote fibre channel port.

- **Enable** check box when selected (default) allows pressing the **Login** button to start the login process.
- **Advertised BB_Credit** is the number of frame buffers the local port has available to receive frames from the remote port: **1** to **65535** (default is **10**). **Advertised BB_Credit** is advertised to the remote port through the **Login** process. Changing the **Advertised BB_Credit** requires to manually re-send a login using the **Login** button.
- **Login/Re-Login** button allows the initiation of the Login process with the selected **Advertised BB_Credit**. Available when the **Login - Enable** check box is selected. The **Login** button initiates a log-in when not logged-in while the **Re-Login** re-initiates a log-in after changing the **BB_Credit** and/or **WWN** when already logged-in. The capability to login is available only with Framed Layer 2 (FC-2) when a successful link has been established. There are two Login processes supported by Fibre Channel: **Port Login** (PLOGI) and **Fabric Login** (FLOGI).

It is possible to skip the **Login** procedure and use the **BB_Credit** value. This is called **Implicit Login** and is only applicable for **Point-to-Point** topology. For **Point-to-Point** topology using implicit login, you must manually configure the **Available BB_Credit** value for the remote port.

- **Discovered Topology** indicates the discovered topology.

Fabric: Ports are interconnected to a fabric switching network. A **Fabric** and **Port** login are required, and the **BB_Credit** value is set based on the buffer capacity of the fabric switch.

Point To Point: Direct link between two ports.

Test Setup - Test Configurator, Timer, and System

Fibre Channel

- **Fabric Status** indicates the status of the Fabric switching network. The status is not available when the discovered topology is Point-to-Point.
 - **Logged-in** indicates that the login process has completed successfully.
 - **Failed** indicates that the login process is not completed successfully or an error has been detected.
 - **In Progress** indicates that the login process is running (not completed yet).
 - **Logged-out** (default) indicates that the system has not logged in yet or has received a valid Logout command from the remote port.
- **Port Status** indicates the state of the port login process.
 - **Logged-in** indicates that the login process has completed successfully.
 - **Failed** indicates that the login process is not completed successfully or an error has been detected.
 - **In Progress** indicates that the login process is running (not completed yet).
 - **Logged-out** (default) indicates that the system has not logged in yet, has received a valid Logout command from the remote port, or the Fabric status is either Failed, In Progress, or Logged-out.

Frequency

From the **Test** menu, tap **Setup**, **Test Configurator**, tap on the interface block, and on the **Frequency** tab.

TX Frequency

- **TX Frequency (GHz)** indicates the frequency (actual frequency + Frequency offset) used for transmission.

Note: *Frequency offset is not available with Multi-Channel OTN.*

- **Offset (ppm)** check box, when selected (cleared by default), allows setting the frequency offset that will be generated. Use the “+” or “-” button to respectively increment or decrement the frequency offset value based on the defined **Increment/Decrement Size**, or directly type the frequency offset value in the field. The range is ± 120 ppm for Ethernet test applications, and ± 50 ppm for Transport Framed, and ± 120 ppm for Transport Unframed test applications.

Interface	Frequency Offset ^a	Nominal Frequency
OTU3	± 50 ppm (Framed)	43018413559 bit/s
OTU3e1	± 120 ppm (Unframed)	44571000000 bit/s
OTU3e2		44583000000 bit/s
OTU4		111810000000 bit/s

- The frequency offset range is guaranteed for a source signal at 0 ppm. In the event that the source signal already has an offset, then the output signal may exhibit an offset larger than the range specified.

Step Size (ppm) allows setting the increment/decrement value (from 0.1 to either 50 or 120 depending on the test configuration) that will be used when changing the frequency offset with the “+” or “-” button.

Test Setup - Test Configurator, Timer, and System

Frequency

Note: The following frequency statistics are available for each lane.

RX Frequency

- **Frequency (GHz)** indicates the frequency of the input signal.
- **Offset (ppm)** indicates the frequency offset between the standard rate specification and the rate at the input signal.

Note: For both **Frequency** and **Offset** the following background colors are used.

Background color	Description
Green	The frequency is in range.
Red	The frequency is out-of-range or LOC Lane. LOC is also displayed.
Gray	Pending state.

- **Max. Negative Offset (ppm)** indicates the maximum negative frequency offset between the standard rate specification and the rate from the received signal.
- **Max. Positive Offset (ppm)** indicates the maximum positive frequency offset between the standard rate specification and the rate from the received signal.

Note: Refer to Interface on page 374 for more information on standard rate specifications.

FTFL/PT and PT

For OTN BERT and OTN-SONET/SDH BERT: From the **Test** menu tap **Setup**, **Test Configurator**, tap on the interface block, and on the **FTFL/PT** tab.

For Multi-Channel OTN: From the **Test** menu, tap **Setup**, **Test Configurator**, tap on either:

- the interface block, and on the **PT** tab to configure the higher ODU layer.
- the test block (**ODU Channels**), and on the **PT** tab to configure the lower ODU layer.

ODUx Buttons

Tap on an **ODUx** button to select the multiplexed level. Not available with Multi-Channel OTN lower ODU level.

Test Setup - Test Configurator, Timer, and System

FTFL/PT and PT

FTFL

Allows the configuration of the Forward and Backward ODU Fault Type Fault Location (FTFL) to be generated. Not available with Multi-Channel OTN.

- **Overwrite**¹ check box when selected generates the defined FTFL.
- **Fault Indication** and **Fault Indication Code** allow the selection of the FTFL fault indicator message/code (byte 0 for forward, byte 128 for backward) to be generated.

Fault Indication	Fault Indication Code (Hex)
No fault	00 (default)
Signal fail	01
Signal Degrade	02
Reserved	03 ^a

- a. Selecting **Reserved** will use the hexadecimal code **03** but, all codes from **03** to **FF** are reserved for future international standardization.

Note: *The **Fault Indication Code** field is automatically updated when the **Fault Indication** is changed and vice versa.*

- **Operator Identifier** allows editing the Operator Identifier to be generated (bytes 1 to 9 for forward, bytes 129 to 137 for backward; 9 characters allowed). By default no Operator Identifier is defined.
- **Operator Specific** allows editing the Operator Specific to be generated (bytes 10 to 127 for forward, bytes 138 to 255 for backward; 118 characters allowed). By default no Operator Specific is defined.

1. Only available with Through Intrusive topology and applies only to the ODU top layer.

PT / Global PT

Note: *Global PT, available with Muti-Channel OTN, indicates that the PT settings apply to all channels.*

Note: *Changing the payload type (PT) does not alter the signal structure; it only modifies the OH value that is generated.*

➤ **Overwrite**¹ check box when selected generates the defined PT.

➤ **Payload Type and Code**

Generated: Allows the selection of the payload signal type to be generated either by selecting the payload type from the list or by entering its code in hexadecimal (**00 to FF**).

Expected: Allows selecting the expected payload signal type.

Note: *Codes not listed in the table are reserved for future standardization (Reserved For International Standardization).*

Payload type	Hex Code	MSB 1234	LSB 5678
Reserved for International Standardization ^a	00	0000	0000
Experimental mapping	01	0000	0001
Asynchronous CBR mapping	02	0000	0010
Bit Synchronous CBR mapping	03	0000	0011
ATM mapping	04	0000	0100
GFP mapping	05	0000	0101
Virtual Concatenation Signal	06	0000	0110
PCS Codeword Transparent Ethernet	07	0000	0111
FC-1200 into ODU2e	08	0000	1000
GFP mapping into extended OPU2	09	0000	1001
OC-3/STM-1 into ODU0	0A	0000	1010

1. Only available with Through Intrusive topology and applies only to the ODU top layer.

Test Setup - Test Configurator, Timer, and System

FTFL/PT and PT

Payload type	Hex Code	MSB 1234	LSB 5678
OC-12/STM-4 into ODU0	0B	0000	1011
FC-100 into ODU0	0C	0000	1100
FC-200 into ODU1	0D	0000	1101
FC-400 into ODUflex	0E	0000	1110
FC-800 into ODUflex	0F	0000	1111
Bit Stream with Octet Timing mapping	10	0001	0000
Bit Stream Without Octet Timing mapping	11	0001	0001
IB SDR mapping into ODUflex	12	0001	0010
IB DDR mapping into ODUflex	13	0001	0011
IB QDR mapping into ODUflex	14	0001	0100
ODU Multiplex with ODTUjk	20	0010	0000
ODU Multiplex with ODTUk.ts/ODTUjk	21	0010	0001
Not Available ^b	55	0101	0101
Reserved Codes for Proprietary Use ^c	80	1000	0000
NULL Test Signal mapping	FD	1111	1101
PRBS Test Signal mapping	FE	1111	1110

- Selecting **Reserved for International Standardization** will use the hexadecimal code 00 but, all codes not listed in the previous table at the exception of those covered in notes b and c are reserved for future standardization.
- Selecting **Not Available** will use the hexadecimal code 55 but, 66 and FF are also Not Available payload types.
- Selecting **Reserved Proprietary** will use the hexadecimal code 80 but, all codes from 80 to 8F are reserved proprietary payload types.

Note: *The Code field is automatically updated when the Payload Type is changed and vice versa.*

- **OPU-PLM**, when selected, enables the OPU-PLM alarm analysis.

GFP-F/GFP-T

Note: Only available with Ethernet **1GbE**, **10GbE**, or **Ethernet (flex/GFP-F)** client.

From the **Test** menu, tap **Setup**, **Test Configurator**, and tap on the **GFP-F/GFP-T** block.

Note: Refer to Generic Framing Procedure (GFP) on page 727 for more information on *Client Data* and *Client Management frames*.

- **CDF pFCS** (Client Data Frames payload Frame Check Sequence) enables the presence of the payload FCS for the client frames. This setting is only available with **Ethernet (flex/GFP-F)** client.
- **CMF pFCS** (Client Management Frames payload FCS) enables the presence of the payload FCS for the management frames. The **CMF pFCS** check box is automatically cleared when injecting FDI or RDI alarms.
- **EXI** (Extension Header Identifier) allows the selection of the type of GFP Extension Header. Choices are **Null** (0000) - (Default) and **Linear** (0001). EXI is only configurable with **Ethernet (flex/GFP-F)** client.
- **CID** (Channel Identifier) selects the communication channel used for the signal transmission for *both Client Data and Client Management frames*. Choices are from **0** (default) through **255**. CID is only available when EXI is set to **Linear**.

The status **Mismatch** is displayed next to the CID value when the TX and RX CID values differ.

- **Delta** indicates the GFP state machine synchronization parameter. Delta is set to 1.

Test Setup - Test Configurator, Timer, and System

Interface (Ethernet, Packet Sync, Fibre Channel, and Wireless)

Interface (Ethernet, Packet Sync, Fibre Channel, and Wireless)

From the **Test** menu, tap **Setup, Test Configurator**, the interface block, and the **Interface** tab.

LINK

An arrow is used to indicate the port link status (at the PCS level for parallel interfaces): link up (green arrow), error or link down (red arrow), or awaiting incoming data to provide a status (gray arrow).

Note: Refer to *Ethernet* on page 359, *Ethernet - PCS* on page 362, and *PHY* on page 400 for more information on alarms.

For 25GE framed Ethernet interface:

RS-FEC check box when selected (default) enables the use of the RS-FEC.

For 100GE (4 Lanes) framed Ethernet interface:

RS-FEC check box when selected (default), enables the use of the RS-FEC. The **RS-FEC** check box must be selected when using a 100GBASE-SR4 or 100GE-CWDM4 transceiver and may be selected for 100GE-CLR4; ensure both ends of the circuit have the FEC enabled. Only available when the **PHY Type** is set to any except **LR4/ER4** (see page 121).

Test Setup - Test Configurator, Timer, and System

Interface (Ethernet, Packet Sync, Fibre Channel, and Wireless)

For 400GE (8 Lanes) framed Ethernet interface:

RS-FEC (RX Only) check box when selected (default) enables the use of the RS-FEC in RX; when cleared, ignores RS-FEC parity symbols, detection of FEC errors, and no correction of message symbols are performed.

FEC Degraded SER check box when selected, enables the monitoring of local/remote degraded SER alarms. Only available when **RS-FEC (RX Only)** check box is selected.

Thresholds is available when **FEC Degraded SER** is enabled and allows setting the threshold values used to raise and clear the **Local Degraded SER Detected** alarm.

The alarm is raised when the number of symbol errors is higher than the **Activate Threshold (Symbols)** defined. The alarm is cleared when the number of symbol errors is lower than the **Deactivate Threshold (Symbols)** defined.

- **Interval (CW)** defines the number of codewords (interval) used by the FEC decoder to count the number of symbol errors detected.
- **Activate Threshold (Symbols)** defines the number of detected symbols required to declare the **Local Degraded SER Detected** alarm.
- **Deactivate Threshold (Symbols)** defines the number of detected symbols required to clear the **Local Degraded SER Detected** alarm.

Test Setup - Test Configurator, Timer, and System

Interface (Ethernet, Packet Sync, Fibre Channel, and Wireless)

For EtherBERT test application:

- **Remote Fault Emulation** check box when selected, generates **Remote Fault** ordered sets when a **Link Fault** is received. Only available with EtherBERT, 10GE (all framing at the exception of **Seed A/B** and **PRBS31 Unscrambled**), and 40GE/100GE (**Framed Layer 2** and up).

For Ethernet and Packet Sync test applications:

- For optical interfaces, the **Local Fault Detected**, **Local Fault Received**, **Remote Fault**, **LOA**, **Hi-BER**, and/or **WIS Link** (10GE WAN) alarm status are displayed. Refer to *Ethernet* on page 359 and *Ethernet - PCS Lanes* on page 364 for more information.
- **Auto-Negotiation** check box is available with **10/100/1000M Electrical** and **1GE Optical** interfaces. When the **Auto-Negotiation** check box is selected the test application indicates to the remote port which parameters to use. The **Auto-Negotiation** check box is automatically selected (not configurable) for 1GE Electrical interface and when using an active copper SFP.

Note: *When the **Auto-Negotiation** check box is selected, the port **Speed**, **Duplex**, **Flow Control**, and **Local Clock** parameters can be set. Those settings are not applied immediately to the port, they are used only when the negotiation process is started and take effect only when the auto-negotiation succeeds. However current settings are applied immediately to the port when the **Auto-Negotiation** check box is cleared.*

Test Setup - Test Configurator, Timer, and System

Interface (Ethernet, Packet Sync, Fibre Channel, and Wireless)

- **Speed**, available with **10/100/1000M Electrical** interface, allows the selection of the interface rate: **10M**, **100M**, **1GE**, or **Auto**¹. The negotiated speed will be displayed next to the **Speed** field selection. The **10M** speed is not available with SyncE test application.
- **Duplex** choices for **10M** and **100M** electrical interfaces are **Full Duplex** (default), **Half Duplex**, and **Auto**¹. For other rates the Duplex is set to **Full Duplex**. Availability of choices depend on the test applications. Half Duplex is not available with an active copper SFP. The negotiated duplex will be displayed next to the **Duplex** field selection.
- **Flow Control** choices are **Enable TX**, **Enable RX**, **Enable RX and TX**, **None** (default), and **Auto**¹. When the **Flow Control** is set to **None**, pause frames received are ignored. Availability of choices depend on test applications.
- **Cable Mode** is available with **10/100/1000M Electrical** interface. Availability of choices depend on the test application.

Manual mode is selected when the **Auto-Negotiation** check box is cleared and allows selecting the type of cable: **MDI** (default) for straight through cable or **MDIX** for crossover cable.

Automatic mode is selected when the **Auto-Negotiation** check box is selected and allows the module to automatically detect the MDI or MDIX cable type.

- **Local Clock** is only available with 1GE electrical interface and allows setting the source of the clock: **Master** (default), **Slave**², or **Auto**^{1,3}.

1. **Auto** is only available when the **Auto-Negotiation** check box is selected.

2. **Slave** is the only available choice for Wander test application.

3. Not available with SyncE test application.

Test Setup - Test Configurator, Timer, and System

Interface (Ethernet, Packet Sync, Fibre Channel, and Wireless)

For Fibre Channel test application:

- **PSP (Link Protocol)** (Primitive Sequence Protocol) check box when selected (default) allows link management by activating the port.

For CPRI **Unframed** test application:

- **Scrambling** check box when selected (default) enables the scrambler. Only available with CPRI rates 4.9152 Gbit/s and higher.

For CPRI **Framed L2** test application:

- **Sequence** indicates the last Startup Sequence State: **Standby (A)**, **L1 Sync (B)**, **Protocol (C)**, **L2 C&M (D)**, **Vendor (E)**, **Operation (F)**, or **Passive (G)**. **Frame Sync** indicates the synchronization status: green for active, red for inactive, or gray for pending.
- **Protocol** defines how the CPRI Startup Sequence negotiates the protocol version.
 - **Auto** can use protocol **Version 1** and **Version 2** during the negotiation.
 - **Version 1** negotiates the protocol with Scrambling disabled. Available with all supported CPRI rates.
 - **Version 2** negotiates the protocol with Scrambling enabled. Available with CPRI rates: 9.8, 6.1, and 4.9 Gbit/s.

Protocol table indicates either the last received (**Version 1** or **Version 2**) or negotiated (**Auto**) protocol version. A light-red background indicates a Protocol version mismatch between the received value and the expected generated value.

Test Setup - Test Configurator, Timer, and System

Interface (Ethernet, Packet Sync, Fibre Channel, and Wireless)

- **C&M Channel** defines the kind of channel that will be used by the startup sequence for negotiation.
 - **Auto** (default): Overhead byte #Z.66.0 can use any of the HDLC rates and Overhead byte #Z.194.0 can use any of the Ethernet Subchannel in the negotiation process.
 - **HDLC**: Only overhead byte #Z.66.0 is used with the configured HDLC Rate during the negotiation process. Ethernet #Z.194.0 byte is set to rr00 0000 as it is disabled.
 - **Ethernet**: Only overhead byte #Z.194.0 is used with the configured Ethernet Subchannel during the negotiation process. HDLC #Z.66.0 byte is set to rrrr r000 as it is disabled.
 - **Disabled**: Both HDLC Rates and Ethernet Subchannel are disabled to simulate a Passive Link. Ethernet #Z.194.0 byte is set to rr00 0000 and HDLC #Z.66.0 byte is set to rrrr r000. Only available with **Base Station** emulation mode.

C&M table indicates either the received (HDLC or Ethernet) or negotiated (Auto) C&M for Ethernet subchannel and HDLC rates in Mbit/s. A red background indicates either a C&M type mismatch or HDLC Rate/Ethernet subchannel mismatch compared to the generated C&M channel. An arrow is displayed indicating which C&M Channel should normally be selected as per the standard rules.

- **Subchannel** selects the Ethernet Subchannel number: **20** to **63** where 63 is the lowest bit rate and 20 the highest.

Test Setup - Test Configurator, Timer, and System

Interface (Ethernet, Packet Sync, Fibre Channel, and Wireless)

- **Rate (Mbit/s)** is available with **HDLC** and **Ethernet C&M Channel**.

For **HDLC**: Allows the selection of the HDLC bit rate. Choices depend on the selected CPRI interface rate. HDLC **Proprietary** is used to exercise a case where the Base Station is aware in advance of the HDLC rate to use. The proprietary rate are not described in the standard. If an HDLC Proprietary is received during the negotiation process while the **C&M Channel** is set to **Auto**, the negotiation completes but no actual bit rate is reported as it is unknown. Similarly, if an equipment vendor uses an invalid rate (as per the CPRI Standard) during the negotiation process, this rate is reported as **Unspecified (Code)** where **Code** is a decimal value representing an invalid rate based on the configured interface rate.

CPRI Rate (Gbit/s)	HDLC Rate (Mbit/s)
1.2	0.240, 0.480, 0.960 (default), Proprietary
2.4	0.240, 0.480, 0.960, 1.920 (default), Proprietary
3.1	0.240, 0.480, 0.960, 1.920, 2.400 (default), Proprietary
4.9	0.240, 0.480, 0.960, 1.920, 2.400, 3.840 (default), Proprietary
6.1	0.240, 0.480, 0.960, 1.920, 2.400, 4.800 (default), Proprietary
9.8	0.240, 0.480, 0.960, 1.920, 2.400, 7.680 (default), Proprietary

For **Ethernet**: Indicates the bit rate corresponding to the selected **Subchannel**.

Test Setup - Test Configurator, Timer, and System

Interface (Ethernet, Packet Sync, Fibre Channel, and Wireless)

For OBSAI Framed L2 test application:

- **Sync** indicates the RX State Machine status: green for FRAME_SYNC, gray for pending, or red for other states. The TX and RX State Machines are also displayed.
- **Force TX Idle** check box when selected forces the TX State Machine to Idle state and when cleared (default) allows the TX State Machine to operate normally.
- **Scrambling** check box when selected (default) enables the scrambler. Only available with OBSAI 6.1 Gbit/s rate.

TX Seed is the start value of the scrambler training process: **0x01** (default) to **0x7F** limited to the Seed values defined in the standard.

RX Seed is the current seed value detected.

- **Frame Clock Burst Generation** check box when selected (default) enables the generation of the frame clock burst message. Available with base station emulation mode.

Test Setup - Test Configurator, Timer, and System

Interface (Ethernet, Packet Sync, Fibre Channel, and Wireless)

RP3 Address (OBSAI Framed L2)

- **Source** identifies the source node of RP3 messages: **0000** to **1FFF**; default is **1234**. The RP3 address 1FFF corresponds to the empty message address that is dropped according to the standard.
- **Target** identifies the peer node that is receiving the RP3 messages: **0000** (default) to **1FFF**.
- **Peer Target** indicates the RP3 Peer Target Address; indicates a mismatch when displayed in red.
- **Address Mismatch** check box when selected, cleared by default, enables the monitoring of the mismatch between the Source and received Peer Target addresses.

RP3 Message (OBSAI Framed L2)

- **Type** identifies the type of RP3 Data Message generated by the OBSAI node: **WCDMA/FDD** (00010) - (default), **LTE** (01110), **GSM/EDGE** (00100), and **802.16** (01100).
- **Msg Grp/Frame (N_MG)** indicates the number of Message Group per Frame parameter.
- **Msg/Grp (M_MG)** indicates the number of Message per Message Group parameter.
- **Idle/Grp (K_MG)** indicates the number of Idle per Message Group parameter.

ESMC Generation

Note: *Available with Wander test application with SyncE rates.*

Generated QL allows the selection of the QL message that will be generated. See page 450 for the list of QL message (default is **QL-DNU/DUS**).

WIS Button

Note: *WIS is only available for 10GE WAN interface.*

- **J0 Trace** allows setting the **J0 Trace** value in 16 bytes format (default is **EXFO 10GigE**).
- **J1 Trace** allows setting the **J1 Trace** value in 16 bytes format allowing up to 15 bytes (a CRC-7 byte will be added in front for a total of 16 bytes). Default is **EXFO 10GigE**.

Note: *J0 and J1 values should be 7-bit T.50 suitable characters. The **Padding** drop list from the message keyboard allows selecting **Null** or **Space** to fill up the **J0 Trace** and **J1 Trace** up to 15 byte value. The **Control Characters** button in the **J0 Trace** and **J1 Trace** message keyboard, allows selecting the required character. For more details on **Control Characters**, see page 40.*

- **Path Signal Label (C2)** byte is allocated to indicate the content of the STS SPE, including the status of the mapped payload.

C2 (Hex.)	Description
00	Unequipped
01	Equipped - Non-Specific
1A ^a	10 Gbit/s Ethernet (IEEE 802.3)
FE	Test Signal, ITU-T 0.181

- a. Default value.

Test Setup - Test Configurator, Timer, and System

Interface (Ethernet, Packet Sync, Fibre Channel, and Wireless)

Physical Interface

For parallel interfaces, the following information is displayed for each optical lane.

- **Optical Lane** indicates the optical lane number.

Optical Interface	Optical Lane Number
40GE (4 Lanes) [41.25 Gbit/s] 100GE (4 Lanes) [103.125 Gbit/s]	0 through 3
400GE (8 Lanes) [425 Gbit/s]	0 through 7

- **Laser** indicates the status of the laser: **ON** with the laser pictogram (emitting an optical laser signal) or **OFF**.
- **TX Power (dBm)** indicates, when supported, the transmit power level of the optical lane/laser in dBm.
- **Wavelength (nm)** indicates the detected wavelength when supported by the transceiver.
- **RX Power (dBm)** indicates, when supported, the current received power level of the optical laser/lane in dBm.

Green: Power level in range.

Yellow: Power level out-of-range.

Red: Loss of signal or power level is close to damage.

Gray: Invalid operational range value or not available/supplied by the transceiver.

- **Min RX Power (dBm)** indicates, when supported, the minimum received power level of the optical laser/lane in dBm.
- **Max RX Power (dBm)** indicates, when supported, the maximum received power level of the optical laser/lane in dBm.

Test Setup - Test Configurator, Timer, and System

Interface (Ethernet, Packet Sync, Fibre Channel, and Wireless)

- **Laser ON/OFF** button, available with parallel interfaces, is used to activate the laser control per optical lane or for all lanes.

Optical lane numbers are from **0 to 3** or **0 to 7** depending on the selected interface/rate.

- **All Lanes** check box, when selected, applies the change(s) to all optical lanes at once.
- **Optical Lane** indicates the optical lane numbers and **All** which represents the setting for all optical lanes when the **All Lanes** check box is selected.
- **Laser** check box, when selected, indicates that the corresponding optical laser lane is activated and emitting an optical laser signal.
- **Lasers OFF at Start-Up** check box when selected automatically turns OFF the laser for serial interfaces or all lasers for parallel interfaces when starting the module or when switching from one test application to another; this applies on both ports for **Dual Port** topology. However the laser remains ON, on a remote module receiving a request for a DTS connection or a loopback command. This check box is cleared by default.
- **Power Range (dBm)** indicates the transceiver operational RX power range.

Test Setup - Test Configurator, Timer, and System

Interface (Ethernet, Packet Sync, Fibre Channel, and Wireless)

TX Frequency

Note: *The following TX Frequency information applies to serial interface only, refer to TX Frequency on page 175 for parallel interfaces. Not available when using an active copper SFP.*

- **TX Frequency (GHz)** indicates the frequency (actual frequency + Frequency offset) used for transmission.

Note: *Frequency offset is not available with OBSAI, CPRI in RRH emulation mode, RFC 6349 test application.*

- **Offset (ppm)** check box, when selected (cleared by default), allows setting the frequency offset that will be generated: ± 120 ppm for all Ethernet rates at the exception of 10GE WAN which is ± 50 ppm; not supported for 10M electrical. Use the “+” or “-” button to respectively increment or decrement the frequency offset value based on the defined **Increment/Decrement Size**, or directly type the frequency offset value in the field.
- **Step Size (ppm)** allows setting the increment/decrement value (from 0.1 to the maximum offset) that will be used when changing the frequency offset with the “+” or “-” button.

RX Frequency

Note: The following RX Frequency information applies to serial interface only, refer to RX Frequency on page 176 for parallel interfaces. Not available when using an active copper SFP.

- **Frequency (GHz)** indicates the frequency of the input signal.
- **Offset (ppm)** indicates the frequency offset between the standard rate specification and the rate at the input signal.

Note: For both **Frequency** and **Offset** the following background colors are used.

Background color	Description
Green	The frequency is in range.
Red	The frequency is out-of-range or LOC Lane. LOC is also displayed.
Gray	Pending state.

- **Max Offset (ppm)**

Negative indicates the maximum negative frequency offset between the standard rate specification and the rate from the received signal.

Positive indicates the maximum positive frequency offset between the standard rate specification and the rate from the received signal.

Labels

For SONET/SDH BERT, from the **Test** menu, tap **Setup, Test Configurator**, the interface block, and on the **Labels** tab.

For OTN-SONET/SDH BERT, from the **Test** menu, tap **Setup, Test Configurator**, the protocol block, and on the **Labels** tab.

Note: *Selecting a Label byte to be generated will automatically update the corresponding OH byte. Refer to OH - SONET/SDH on page 591 for more information.*

Labels

- **STS/AU Path (C2):** The C2 byte is allocated to indicate the content of the STS SPE / VC, including the status of the mapped payloads.

Generated: Select the C2 byte from the list. Selecting a C2 byte value will automatically update the OH C2 selection and vice versa. Refer to C2 on page 599 for more information.

- **PLM-P/UNEQ-P / HP-PLM/HP-UNEQ:** Enables the Payload Mismatch and STS/AU UNEQ monitoring. This setting is coupled with the configuration of *Traces - SONET/SDH* on page 527.

Expected: Select the expected C2 byte from the list. Refer to C2 on page 599 for more information.

- **VT/TU Path (V5):** The V5 byte is allocated to indicate the content of the VT/TU path, including the status of the mapped payloads.
- **Generated:** Select the V5 byte from the list. Selecting a V5 byte value will automatically update the OH V5 selection and vice versa. Refer to V5 on page 602 for more information.

- **PLM-V/UNEQ-V / LP-PLM/LP-UNEQ:** Enables the Payload Mismatch and VT/TU UNEQ monitoring. This setting is coupled with the configuration on the *Labels* on page 427.
- **Expected:** Select the expected V5 byte from the list. Refer to V5 on page 602 for more information.

Link OAM

From the test menu, tap **Setup, Test Configurator**, and the **Link-OAM (802.3)** test block.

OAM Mode

Allows the selection of the OAM mode:

- **Active** (default) initiates the OAM discovery and send OAMPDU loopback control; doesn't respond to variable request nor generate Link Event Notification.
- **Passive** doesn't initiate OAM discovery nor send OAMPDU loopback control.

OAMPDU Destination MAC Address

Indicates and allows changing the default multicast OAM PDU destination MAC address: **01:80:C2:00:00:02**.

Default check box when cleared (default is selected), allows the configuration of the OAM PDU destination MAC address:

00:00:00:00:00:00 to **FF:FF:FF:FF:FF:FF**.

Pass/Fail Verdict

Pass/Fail Verdict check box when selected (default) enables the use of the pass/fail verdict. A global fail verdict is declared when any of the following condition is met: **Link Down**, any Link OAM alarm, **Remote Alarms** (if enabled), or **Remote Loopback** (if enabled).

- **Remote Alarms** check box when selected (default) considers the following alarms to declare the pass/fail verdict: **Critical Event**, **Dying Gasp**, and **Link Fault**.
- **Remote Loopback** check box when selected (default) considers successful/unsuccessful remote loopback request to declare the pass/fail verdict.

OAM Discovery Status

- **Local** reports the local OAM discovery status as follows:

Status	Description
Evaluating	OAM discovery is started.
Stable	OAM discovery is completed. Local OAM is satisfied with the remote OAM settings.
Unsatisfied	OAM discovery cannot complete successfully. Local OAM equipment is unsatisfied with the remote OAM settings.

- **Remote** reports the remote OAM discovery status as follows:

Status	Description
Evaluating	OAM discovery is started.
Stable	OAM discovery is completed. Remote OAM is satisfied with the local OAM settings.
Unsatisfied	OAM discovery cannot complete successfully. Remote OAM equipment is unsatisfied with the local OAM settings.

Loopback

- **Local and Remote**
 - **Status** indicates the status of the local and remote loopback: **Enabled** represents a Looped-Up condition and **Disabled** a Looped-Down condition.
 - **Enable/Disable** button allows respectively Looping-Up (**Enable**) or Looping-Down (**Disable**).

Local Details (iSAM)

From the **Test** menu, tap **Setup**, **Test Configurator**, and the **More** button from the **Local** block.

LINK

- An arrow is used to indicate the status of the test link (at the PCS level for parallel interfaces).
 - A green arrow indicates that the link is up.
 - A red arrow indicates that the link is down.
 - A gray arrow indicates awaiting incoming data to provide a status.
- **Interface/Rate** or **Port** choices depend on the rates available on the module.

100GE (4 Lanes) [103.125 Gbit/s] 40GE (4 Lanes) [41.25 Gbit/s] 10GE WAN 10GE LAN 1GE Optical 100M Optical 10/100/1000M Electrical ^a
--

- a. For 88200NGE, only possible when using an active copper SFP.

For 10GE WAN, the test uses the WIS default values for J0, J1, and C2 as defined in *WIS Button* on page 191.

- **PHY Type** allows selecting the 100GE (4 Lanes) CFP4/QSFP transceiver PHY type: **LR4/ER4** (default), **SR4**, **CWDM4**, **CLR4**, or **Other**. The PHY type when set to any except **LR4/ER4**, allows enabling RS-FEC (see page 182); ensure both ends of the circuit have the FEC enabled. Only available with 100GE (4 Lanes) framed Ethernet interface.

- **RS-FEC** check box when selected (default), enables the use of the RS-FEC. The **RS-FEC** check box must be selected when using a 100GBASE-SR4 or 100GE-CWDM4 transceiver and may be selected for 100GE-CLR4; ensure both ends of the circuit have the FEC enabled. Only available when the **PHY Type** is set to any except **LR4/ER4**
- **Connector** allows the selection of the module's port.

Interface/Rate	Connector ^a	
	8870/8880	88200NGE
100GE (4 Lanes) [103.125 Gbit/s]	-	Port 1 - CFP4 Port 2 - QSFP
40GE (4 Lanes) [41.25 Gbit/s]	-	Port 2 - QSFP
10GE WAN 10GE LAN	Port 1 - SFP+ Port 2 - SFP+	Port 1 - SFP+
1GE Optical 100M Optical		
10/100/1000M Electrical	Port 1 - RJ45	Port 1 - SFP+ (RJ45) ^b

- a. Availability of connectors depend on the model.
b. Ethernet 10/100/1000M electrical is supported when using an active copper SFP.

- **Auto-Negotiation** check box when selected (default), indicates to the remote port which parameters to use. Only available with **10/100/1000M Electrical** and **1GE Optical** interfaces. For 1GE Electrical interface, the **Auto-Negotiation** check box is automatically selected and is not configurable.

Note: When the **Auto-Negotiation** check box is selected, the port **Speed** can be set. This setting is not applied immediately to the port, it is used only when the negotiation process is started, and takes effect only when the auto-negotiation succeeds. However, the current setting is applied immediately to the port when the **Auto-Negotiation** check box is cleared.

Test Setup - Test Configurator, Timer, and System

Local Details (iSAM)

- **Speed**, available with **10/100/1000M Electrical** interface, allows the selection of the interface rate: **10M**, **100M**, **1GE**, or **Auto**; **Auto** is only available when the Auto-Negotiation check box is selected. The negotiated speed will be displayed next to the Speed field selection.

Note: *Full Duplex is used and there is no Flow Control (pause frames received are ignored).*

- **Lasers OFF at Start-Up** allows automatically turning off all lasers when starting the module or when switching from one test application of the same group (Ethernet or Transport) to another. This check box is cleared by default.

MAC

- **Address** indicates the default and unique Media Access Control (MAC) address given to the Ethernet port.
- **VLAN ID/Priority** check box when selected, cleared by default, enables C-VLAN with VLAN Ethernet type of 8100 and allows setting both VLAN ID and priority.

VLAN ID choices are **0** through **4095**; default is **2**; refer to *VLAN ID and Priority* on page 758 for more information.

Priority choices are **0** (default) to **7**. Refer to *VLAN ID and Priority* on page 758 for more information.

IP

- **IP Version** is set to **IPv4**.
- **Automatic IP (DHCP)** check box, when selected (cleared by default), allows obtaining dynamically an IP address from a DHCP (Dynamic Host Configuration Protocol) server.

Note: *IP Address, Subnet Mask, and Default Gateway are not available when the Automatic IP (DHCP) check box is selected.*

- **IP Address** allows entering the source IP address for the stream. The default setting is 10.10.x.y, where x and y are respectively the two least significant bytes of the port default MAC address.
- **Subnet Mask** allows entering the Subnet Mask for the stream. The default setting is **255.255.0.0**.
- **Default Gateway** check box, when selected (cleared by default), allows entering a default Gateway IP address. When the **Default Gateway** check box is selected, its default address is **0.0.0.0**.

Remote Discovery ID

Remote Discovery ID is used to easily identify this module in case another module is performing a discovery scan. Up to 16 alpha-numeric characters are allowed.

MAC/IP/UDP

Note: Only available with Framed Layer 2 (see **Framing** from the Modify Frame Structure).

From the **Test** menu, tap **Setup**, **Test Configurator**, and...

- For **RFC 2544** and **EtherBERT**, tap on the protocol block.
- For **EtherSAM**, and **Traffic Gen & Mon**, tap on the protocol block, and on the **MAC/IP/UDP** tab. For Traffic Gen & Mon all parameters are configurable per stream. For EtherSAM all parameters are configured per service.

Stream Selection (Traffic Gen & Mon)

The Traffic Gen & Mon test application supports the configuration of up to 16 different streams. Select the stream to be configured by either using the left/right arrow or by tapping over the stream numbers area then tapping on a specific stream number.

Service Selection (EtherSAM)

The EtherSAM test application supports the configuration of up to 10 different services. Select the service to be configured by either using the left/right arrow or by tapping over the service numbers area then tapping on a specific service number.

Couple with Interface

The **Frame Format**, **Network Layer**, and all **IP** and **VLAN** settings are coupled with the interface (see *Network* on page 220) when the **Couple with Interface** check box is selected (default). The **Source MAC Address** is always coupled. Not available when using **Provider Encapsulation**.

Modify Frame Structure

Allows modifying the structure of the frame.

► Global Option

- **S-OAM** check box when selected enables EtherSAM over service OAM at Layer 2 on all services. The EtherSAM uses LBM and LBR messages of the S-OAM protocol to perform the test. A device having the capability to loopback LBM messages (via LBR) is required at the remote. Only available with EtherSAM for rates up to 10G WAN. Not available in Dual Test Set and Dual Port topology.
- **Provider Encapsulation** is available with single port EtherBERT Framed Layer 2 and Traffic Gen & Mon test applications at rates of 10GE, 40GE, and 100GE. Choices are:

None: No encapsulation.

EoE: Ethernet over Ethernet encapsulation.

Destination EoE MAC Address	Source EoE MAC Address	EoE VLAN 0xA100 (4 bytes)	EoE TPID (EtherType) 0xE0E0 (2 bytes)	TTL (1 byte)	Etag (1 byte)	Customer Frame starting with Destination Address without FCS	FCS (4 bytes)
-----------------------------------	------------------------------	---------------------------------	--	-----------------	------------------	---	------------------

PBB-TE: Provider Backbone Bridges with Traffic Engineering encapsulation.

Backbone Destination MAC Address (6 bytes)	Backbone Source MAC Address (6 bytes)	B-VLAN 0x88A8 (4 bytes)	EtherType 0x88E7 (2 bytes)	I-TAG (4 bytes)	Customer Frame starting with Destination Address without FCS	FCS (4 bytes)
---	--	-------------------------------	----------------------------------	--------------------	---	------------------

- **IP Version** allows selecting **IPv4** (default) or **IPv6** that will be used for both the interface and all streams/services.

Test Setup - Test Configurator, Timer, and System

MAC/IP/UDP

➤ Framing

Note: *The framing for EtherSAM in a NAT environment is limited to Ethernet II, IPv4, and UDP.*

- **Frame Format** (layer 2) allows selecting **Ethernet II** (default) or **802.3 SNAP** as the frame format.
- **Network Layer**¹ (layer 3) sets the network traffic type: **IPv4** (default)/**IPv6**, or **None**.
- **Transport Layer**¹ is disabled when the **Network Layer** is **None**.

Test Application	Transport Layer
EtherSAM	None, UDP (default), TCP ^a
RFC 2544	UDP
EtherBERT	UDP (default), TCP ^a
Traffic Gen & Mon	None, UDP (default), TCP ^a

a. Only available for 10M to 10G.

- **MPLS:** The **MPLS Label** check box, when selected (cleared by default), enables 1 or 2 MPLS labels allowing management and test frames to be transmitted and received. Only available with EtherSAM and Traffic Gen & Mon test applications. Not available when using **Provider Encapsulation**. Not available with EtherSAM when the **S-OAM** check box is selected.
- **VLAN:** The **VLAN Tag** check box when selected (cleared by default), enables up to 3 stacked VLAN; up to 2 staked VLAN when using **Provider Encapsulation**.

1. Not available with EtherSAM when the **S-OAM** check box selected. Not available when using Provider Encapsulation. Not configurable and set to None for 40GE and 100GE dual port topology and 400GE test.

- **EoE:** The **EoE VLAN** check box, when selected (cleared by default), enables the EoE VLAN tag. Available when EoE is selected as **Provider Encapsulation**.
- **PBB-TE:** The **B-VLAN** check box, when selected (cleared by default), enables the B-VLAN tag. Available when PBB-TE is selected as **Provider Encapsulation**.

See *VLAN* on page 211 for additional VLAN settings.

Preamble/SFD

Indicates that the frame structure contains the Preamble and SFD.

EoE

Note: *Available when EoE is selected as the Provider Encapsulation (see Modify Frame Structure on page 205).*

- **Source EoE MAC Address** indicates and allows changing (when the **Factory Default** check box is cleared) the default EoE Media Access Control (MAC) address. The default setting is **0E:01:00:xx:xx:xx..**
- **Destination EoE MAC Address** allows entering the destination EoE MAC address for the stream. The default setting is **0E:01:00:00:00:01**.
- **EoE VLAN**

Note: *Only available when the EoE VLAN is enabled; refer to Modify Frame Structure on page 205.*

- **VLAN ID** choices are **0** to **4095** (default is 2); refer to *VLAN ID and Priority* on page 758 for more information.
- **Priority**, VLAN user priority, choices are **0** (default) to **7**. Refer to *VLAN ID and Priority* on page 758 for more information.

Test Setup - Test Configurator, Timer, and System

MAC/IP/UDP

- **Type**, VLAN Ethernet Type, choices are **0x8100**, **0x88A8**, **0x9100**, **0xA100** (default), **0x9200**, and **0x9300**.
- **Drop Eligible:**, when set to **Yes** (DEI = 1), the transmitted frames will be dropped first on receipt when congestion occurs under test. Drop Eligible is not available when VLAN type is 0x8100. This parameter is set to **No** by default.
- **TTL** (Time To Live) choices are **0** to **255** (default is **64**).
- **ETag** (Extended Tag) choices are **0** to **255** (default is **1**).

PBB-TE

Note: Available when PBB-TE is selected as the Provider Encapsulation (see Modify Frame Structure on page 205).

- **Source B-MAC Address** indicates and allows changing (when the **Factory Default** check box is cleared) the default source Backbone MAC address: **00:03:01:xx:xx:xx**.
- **Destination B-MAC Address** allows entering the destination Backbone MAC address. The default setting is **00:00:00:00:00:00**.
- **B-VLAN** (EtherType: 0x88A8) is available when PBB-TE VLAN check box is selected (see Modify Frame Structure on page 205).
 - **VLAN ID** choices are **0** through **4095** (default is **2**). Refer to *VLAN ID and Priority* on page 758 for more information.
 - **Priority** choices are **0** (default) to **7**. Refer to *VLAN ID and Priority* on page 758 for more information.
 - **Drop Eligible:**, when set to **Yes** (DEI = 1), the transmitted frames will be dropped first on receipt when congestion occurs under test. This parameter is set to **No** by default.
- **I-TAG** (EtherType: 0x88E7)
 - **SID** (Service Instance Identifier) choices are **0** through **16777215** (default is **256**).
 - **Priority**, the Priority Code Point (PCP), choices are **0** (default) to **7**. Refer to *VLAN ID and Priority* on page 758 for more information.
 - **Drop Eligible:**, when set to **Yes** (DEI = 1), the transmitted frames will be dropped first on receipt when congestion occurs under test. This parameter is set to **No** by default.

MAC

- **Source MAC Address** indicates the default and unique Media Access Control (MAC) address given to the Ethernet port; editable when using **Provider Encapsulation**.
- **Destination MAC Address:** Enter the destination MAC address for the stream. The default setting is the source MAC address. The destination MAC Address field is not accessible when the **Resolve MAC Address** check box is selected.
- **Resolve MAC Address** check box, when selected (default), sends a request to the network to retrieve the MAC address corresponding to the selected destination IP address. This setting is coupled with the **Resolve MAC Address** check box from *IP* on page 213. This check box is not available when the **Network Layer** is set to **None** (refer to *Modify Frame Structure* on page 205).
- **OAM Quick Ping** button automatically starts the quick Ping utility for the stream destination MAC address and provides either a successful or failed result. The quick Ping uses 3 attempts, a delay of 1 second, and a Timeout of 5 seconds.
- **EtherType** is set to the following values by default and is configurable from **0x0000** to **0xFFFF** when the **Network Layer** is set to **None**:
 - 0x0000** when **Network Layer** is set to **None**
 - 0x0800** for IPv4
 - 0x86DD** for IPv6
 - 0x8847** for MPLS
 - 0x88B7** when **Network Layer** is set to **None** with EtherBERT test.
 - 0x8902** for S-OAM (available with EtherSAM)
- **OUI**, available when the frame format **802.3 SNAP** is selected, allows the selection of the Organizationally Unique Identifier (OUI):
 - RFC1042** (0x000000) - (default)
 - User Defined**, available when **Network Layer** is set to **None**, allows entering the **OUI** value: **0x000000** (default) to **0xFFFFFFFF**.

Note: *Source/Destination Flooding and Flood Range are only available with Traffic Gen & Mon when the Network Layer is set to None (see page 206).*

- **Source Flooding** and **Destination Flooding** check boxes when selected (cleared by default) allows generation of frames using source/destination MAC addresses flooding as follows: The first frame is transmitted starting with the least significant bits of the source/destination MAC address covered by the range set to 0; each subsequent frame is transmitted by incrementing the least significant bits by 1; when the upper limit of the range is reached, the source/destination MAC address restarts over with the least significant bits covered by the range set to 0.
- **Flood Range** is the range of the least significant bits used for the Source Flooding and/or Destination Flooding: **2 (1 bit)**, **4 (2 bits)**, **8 (3 bits)**, **16 (4 bits)**... up to **16777216 (24 bits)** (default).

VLAN

Note: *VLAN is only available when the VLAN Tag is enabled; refer to Modify Frame Structure on page 205.*

For each VLAN tag enabled (C-VLAN/S-VLAN/E-VLAN) the following parameters are configurable.

- **VLAN ID** choices are **0** through **4095**; refer to *VLAN ID and Priority* on page 758 for more information.
- **Priority**, VLAN user priority, choices are **0** (default) to **7**. Refer to *VLAN ID and Priority* on page 758 for more information.
- **Type**, VLAN Ethernet Type, choices are **8100** (default for C-VLAN), **88A8** (default for S-VLAN), **9100** (default for E-VLAN), **9200**, and **9300**.
- **Drop Eligible:**, when set to **Yes** (DEI = 1), the transmitted frames will be dropped first on receipt when congestion occurs under test. Drop Eligible is not available when VLAN type is 8100. This parameter is set to **No** by default.

MPLS

Note: *MPLS is only available when the MPLS Label is enabled; refer to Modify Frame Structure on page 205.*

- **Label** allows the selection of the MPLS TX labels: **0 to 1048575** (default is **16**). Refer to for the list of MPLS labels.
- **COS** allows the selection of the Class Of Service.
 - 0 (000 - Low)** (default)
 - 1 (001 - Low)**
 - 2 (010 - Low)**
 - 3 (011 - Low)**
 - 4 (100 - High)**
 - 5 (101 - High)**
 - 6 (110 - High)**
 - 7 (111 - High)**
- **TTL** allows the selection of the **Time to Live** value: **0 to 255** (default is **128**).

S-OAM

Note: *S-OAM is only available with EtherSAM when the **S-OAM** check box is selected; refer to Modify Frame Structure on page 205.*

MEG/MD Level allows the selection of the Maintenance Entity Group Level / Maintenance Domain Level: **0 to 7** (default).

IP

For **IPv4** the following configuration parameters are available.

- **Automatic IP (DHCP)** check box, when selected (cleared by default), allows obtaining an IP address dynamically from a DHCP (Dynamic Host Configuration Protocol) server.
- **Source IP Address** allows entering the source IP address for the stream. The default setting is 10.10.x.y, where x and y are respectively the two least significant bytes of the port default MAC address. Not available when the **Automatic IP (DHCP)** check box is selected.
- **Destination IP Address** allows entering the destination IP address for the stream. The default setting is the source IP address.

For **IPv6** the following configuration parameters are displayed: **Source Link-Local IPv6 Address**, and **Source Global IPv6 Address**. Tap on the **IPv6 Config** button to access all settings.

- **Link-Local IPv6 Address** (LLA) is used for local communication between on-link neighbors and for Neighbor Discovery process.
 - **Mode**
 - Stateless Auto** (default) allows automatic generation of the IPv6 address based on the MAC address.
 - Static** allows entering the IP Address.
 - **Address**, available with **Static** mode, allows selecting the Link-Local IPv6 Address. The accepted range is from **FE80:0000:0000:0000:0000:0000:0000:0000** to **FE80:0000:0000:0000:FFFF:FFFF:FFFF:FFFF**. The default address is **FE80::[Interface ID]**, where **[Interface ID]** is generated from the source MAC address. When the **Address** field is selected for editing using virtual keyboard, the **Previous IPs** button appears allowing the selection of a previously configured IP address.

- **Global IPv6 Address (GUA)** is used to communicate with on-link neighbors and for global communication with hosts outside the subnet.
 - **Mode**
 - None** disables the **Global IPv6 Address** and the **Default Gateway Address**.
 - Stateless Auto** (default) allows automatic generation of the IPv6 address based on the Link-Local address interface ID and the prefix obtained from the router advertisements. If no Interface ID has been obtained for the **Link Local Address**, the global address will not be generated.
 - Static** allows entering the IP address.
 - **Address**, available with **Static** mode, allows selecting the **Global IPv6 Address**. The accepted range is from **0000:0000:0000:0000::[Interface ID]** to **FFFF:FFFF:FFFF:FFFF::[Interface ID]**. The default address is **2001:0000:0000:0000::[Interface ID]**, where **[Interface ID]** is generated from the source MAC address. When the **Address** field is selected for editing using virtual keyboard, the **Previous IPs** button appears allowing the selection of a previously configured IP address.
 - **Interface ID Coupled**, available when the **Source Global IPv6 Address** mode is **Static**, allows coupling the interface ID of the Global address to the Link-Local source address.
 - Enabled** (default): Only the 64 bit (MSB) prefix ID in the IPv6 address is configurable, and the 64 bit (LSB) Interface ID is not configurable (read-only).
 - Disabled**: The 64 bit (MSB) Prefix ID and 64 bit (LSB) Interface ID in the IPv6 address are configurable.

- **Prefix Mask**, available with **Static** mode, allows specifying a prefix that defines the subnet. The accepted range is **0000:0000:0000:0000:0000:0000:0000:0000** to **FFFF:FFFF:FFFF:FFFF:0000:0000:0000:0000**. For example:

Global Address: 2001:0DB8:0001:0002:02AA:00FF:FE11:1111
Prefix Mask: FFFF:FFFF:FFFF:0000:0000:0000:0000:0000
Corresponding Prefix: 2001:0DB8:0001.
- **Default Gateway** allows the configuration of the default gateway address to forward packets outside the subnet.
- **Mode**

Automatic (default) allows automatic selection of the default gateway.

Static allows entering the default gateway IP address.
- **Address**, available with **Static** mode, allows entering the IP address of the Default Gateway. The accepted range is from **0000:0000:0000:0000:0000:0000:0000:0000** to **FE80:0000:0000:0000:FFFF:FFFF:FFFF:FFFF**. The default address is **FE80:0000:0000:0000:0000:0000:0000:0000**.
- **IPv6 Destination Address** allows selecting the destination IP address for the stream that must start with **FE80**. The accepted range is from **0000:0000:0000:0000:0000:0000:0000:0001** to **FFFF:FFFF:FFFF:FFFF:FFFF:FFFF:FFFF:FFFF**. The default address is **2001::**. When the **Address** field is selected for editing using virtual keyboard, the **Previous IPs** button appears allowing the selection of a previously configured IP address.

Test Setup - Test Configurator, Timer, and System

MAC/IP/UDP

The following configuration parameters are available for both **IPv4** and **IPv6** unless otherwise specified.

- **Quick Ping** button automatically starts the quick Ping utility for the stream destination IP address and provides either a successful or failed result. The quick Ping uses 3 attempts, a Delay of 1 second, a Timeout of 2 seconds, and a Data Size of 32 Bytes. Refer to *Ping & Trace Route* on page 605 for more options.
- **Resolve MAC Address** check box, when selected (default), sends a request to the network to retrieve the MAC address corresponding to the selected destination IP address. This setting is coupled with the Resolve MAC Address check box from *MAC* on page 210. The Resolve MAC address status is displayed. Possible status are:

Status	Description
--	The Resolve MAC address is not enabled.
Resolving	The MAC address is being resolved.
Resolved	The MAC address is resolved.
Failed	The MAC address cannot be resolved.

- **Source IP Multiplier** check box, when selected (cleared by default), allows changing the 7 LSB (Least Significant bit) of the source IP address as specified in the range: **1-128** (default) or **0-127**.
- **Subnet Mask** (IPv4) allows entering the Subnet Mask for the stream. The default setting is **255.255.0.0**. Not available when the **Automatic IP (DHCP)** check box is selected.
- **Default Gateway** (IPv4) check box, when selected (cleared by default), allows entering a default Gateway IP address. When the **Default Gateway** check box is selected, its default address is **0.0.0.0**. The **Default Gateway** address is not configurable when the **Automatic IP (DHCP)** check box is selected.

- **TTL (IPv4) or HOP Limit TTL (IPv6)** sets the Time To Live value: **1** to **255** (default is **128**).
- **Flow Label (IPv6)** is a number used to identify a series of related packets from a source to a destination: **0** (default) to **1048575**.
- **IP TOS/DS (IPv4) or Traffic Class (TOS/DS) - (IPv6)** allows entering either an hexadecimal value, **00** (default) to **FF**, or tap on the **TOS/DS Config** button to set each TOS or DS parameter individually. Changing the **IP TOS/DS** value will affect the **TOS/DS Config** settings and vice versa.
- **TOS/DS Config** button allows setting the Type of Service or the Differentiated Service parameters.

TOS/DS

- **TOS/DS** allows selecting either Type Of Service (TOS) or Differentiated Services (DS).
- **Binary/Hex** allows displaying, once this pop-up is closed, the IP TOS/DOS value either in binary or hexadecimal.

Type Of Service (available when TOS is selected).

- **Precedence** value:
 - 000 (Routine)** (Default)
 - 001 (Priority)**
 - 010 (Immediate)**
 - 011 (Flash)**
 - 100 (Flash Override)**
 - 101 (CRITIC/ECP)**
 - 110 (Internet Control)**
 - 111 (Network Control)**
- **Delay** allows the selection of the delay level: **Normal** (default) or **Low**.
- **Throughput** allows the selection of the throughput level: **Normal** (default) or **High**.

Test Setup - Test Configurator, Timer, and System

MAC/IP/UDP

- **Reliability** allows the selection of the reliability level: **Normal** (default) or **High**.
- **Monetary Cost** allows the selection of the monetary cost level: **Normal** (default) or **Low**.
- **Reserved Bit** allows the selection of the reserved bit value: **0** (default) or **1**.

Differentiated Services (available when **DS** is selected).

- **DSCP Codepoints:**
000000 (CS0) (default), **001000 (CS1)**, **010000 (CS2)**,
011000 (CS3), **100000 (CS4)**, **101000 (CS5)**, **110000 (CS6)**,
111000 (CS7), **001010 (AF11)**, **001100 (AF12)**, **001110 (AF13)**,
010010 (AF21), **010100 (AF22)**, **010110 (AF23)**, **011010 (AF31)**,
011100 (AF32), **011110 (AF33)**, **100010 (AF41)**, **100100 (AF42)**,
100110 (AF43), **101110 (EF)**, **110011 (51)**, **110110 (54)**, or
User Defined.
- **User Defined Codes**, available when **User Defined** has been selected from the **DSCP codepoints**, allows entering a user defined code from hexadecimal **00** (default) to **3F** once the **TOS/DS Config** pop-up is closed.
- **ECN** allows the selection of the Explicit Congestion Notification code: **00 (Not-ECT)** (default), **01 (ECT-1)**, **10 (ECT 0)**, or **11 (CE)**.

UDP

Allows the selection of the source and destination UDP port number.

- **Source Port** is configurable from **0** to **65535**; the default is **49184**.
- **Destination Port** is configurable from **0** to **65535**; the default is **7 (echo)**.

TCP

Allows the selection of the source and destination TCP port number.

- **Source Port** is configurable from **0** to **65535**; the default is **49184**.
- **Destination Port** is configurable from **0** to **65535**; the default is **7 (echo)**.

Payload

For RFC 2544 and EtherBERT, indicates that the frame structure contains a Payload.

For Traffic Gen & Mon, allows the selection of both user defined header and pattern. Payload is not configurable when the **QoS Metrics Tags Insertion** check box is selected (see the **Global** tab).

- **User Defined Header** check box when selected (cleared by default) allows defining a 16-byte header.
- **Pattern** allows the selection of a pattern: **00** to **FF** (default is **CC**).

FCS

Indicates that the frame structure contains an Ethernet FCS.

Network

From the test menu tap **Setup, Test Configurator**, the interface block, and the **Network** tab.

Note: *For Through Mode test application, the Network tab is only available for the Primary Port but the configured parameters apply to both ports.*

MAC

- **MAC Address** indicates and allows changing, when the **Factory Default** check box is cleared, the default and unique Media Access Control (MAC) address given to the Ethernet port.
- **Factory Default** check box, when selected (default), indicates that the factory source MAC address is used.
- **Frame Format** (layer 2) allows selecting **Ethernet II** (default) or **802.3 SNAP** as the frame format.

IP

IP Version allows the selection of either **IPv4** (default) or **IPv6**. Only IPv4 is supported for TCP Throughput and RFC 6349 test applications.

For **IPv4** the following configuration parameters are available.

- **Automatic IP (DHCP)** check box, when selected (cleared by default), allows obtaining an IP address dynamically from a DHCP (Dynamic Host Configuration Protocol) server.
- **IP Address**¹: Enter the IP address of the port. The default setting is 10.10.x.y, where x and y are respectively the two least significant bytes of the port default MAC address.
- **Subnet Mask**¹: Enter the Subnet Mask. The default setting is **255.255.000.000**.
- **Default Gateway**¹ check box, when selected (cleared by default), allows entering a default Gateway IP address. When the **Default Gateway** check box is selected, its default address is **0.0.0.0**.

1. Not configurable when the **Automatic IP (DHCP)** check box is selected.

Test Setup - Test Configurator, Timer, and System

Network

For **IPv6** the following configuration parameters are displayed: **Link-Local IPv6 Address**, **Global IPv6 Address**, and **Default Gateway**. Tap on the **Config** button to access all settings.

- **Link-Local IPv6 Address** (LLA) is used for local communication between on-link neighbors and for Neighbor Discovery process.
 - **Mode**
 - Stateless Auto** (default) allows automatic generation of the IPv6 address based on the MAC address.
 - Static** allows entering the IP Address.
 - **Address**, available with **Static** mode, allows selecting the Link-Local IPv6 Address. The accepted range is from **FE80:0000:0000:0000:0000:0000:0000:0000** to **FE80:0000:0000:0000:FFFF:FFFF:FFFF:FFFF**. The default address is **FE80::[Interface ID]**, where **[Interface ID]** is generated from the source MAC address. When the **Address** field is selected for editing using virtual keyboard, the **Previous IPs** button appears allowing the selection of a previously configured IP address.

- **Global IPv6 Address (GUA)** is used to communicate with on-link neighbors and for global communication with hosts outside the subnet.
 - **Mode**
 - None** disables the **Global IPv6 Address** and the **Default Gateway Address**.
 - Stateless Auto** (default) allows automatic generation of the IPv6 address based on the Link-Local address interface ID and the prefix obtained from the router advertisements. If no Interface ID has been obtained for the **Link Local Address**, the global address will not be generated.
 - Static** allows entering the IP address.
 - **Address**, available with **Static** mode, allows selecting the **Global IPv6 Address**. The accepted range is from **0000:0000:0000:0000::[Interface ID]** to **FFFF:FFFF:FFFF:FFFF::[Interface ID]**. The default address is **2001:0000:0000:0000::[Interface ID]**, where **[Interface ID]** is generated from the source MAC address. When the **Address** field is selected for editing using virtual keyboard, the **Previous IPs** button appears allowing the selection of a previously configured IP address.
 - **Interface ID Coupled**, available when the **Source Global IPv6 Address** mode is **Static**, allows coupling the interface ID of the Global address to the Link-Local source address.
 - Enabled** (default): Only the 64 bit (MSB) prefix ID in the IPv6 address is configurable, and the 64 bit (LSB) Interface ID is not configurable (read-only).
 - Disabled**: The 64 bit (MSB) Prefix ID and 64 bit (LSB) Interface ID in the IPv6 address are configurable.

Test Setup - Test Configurator, Timer, and System

Network

- **Prefix Mask**, available with **Static** mode, allows specifying a prefix that defines the subnet. The accepted range is **0000:0000:0000:0000:0000:0000:0000:0000** to **FFFF:FFFF:FFFF:FFFF:0000:0000:0000:0000**. For example:

Global Address: 2001:0DB8:0001:0002:02AA:00FF:FE11:1111
Prefix Mask: FFFF:FFFF:FFFF:0000:0000:0000:0000:0000
Corresponding Prefix: 2001:0DB8:0001.
- **Default Gateway** allows the configuration of the default gateway address to forward packets outside the subnet.
- **Mode**
 - Automatic** (default) allows automatic selection of the default gateway.
 - Static** allows entering the default gateway IP address.
- **Address**, available with **Static** mode, allows entering the IP address of the Default Gateway. The accepted range is from **0000:0000:0000:0000:0000:0000:0000:0000** to **FE80:0000:0000:0000:FFFF:FFFF:FFFF:FFFF**. The default address is **FE80:0000:0000:0000:0000:0000:0000:0000**.

VLAN

VLAN Tag check box, when selected (cleared by default), enables and allows setting up to 3 stacked VLANs.

For each VLAN tag enabled, C-VLAN / S-VLAN / E-VLAN, the following parameters are configurable.

- **VLAN ID** choices are **0** through **4095**; refer to *VLAN ID and Priority* on page 758 for more information.
- **Priority**, VLAN user priority, choices are **0** (default) to **7**. Refer to *VLAN ID and Priority* on page 758 for more information.
- **Type**, VLAN Ethernet Type, choices are **0x8100** (default for C-VLAN), **0x88A8** (default for S-VLAN), **0x9100** (default for E-VLAN), **0x9200**, and **0x9300**.
- **Drop Eligible**, when set to **Yes** (DEI = 1), the transmitted frames will be dropped first on receipt when congestion occurs under test. Drop Eligible is not available when VLAN type is 8100. This setting is set to **No** by default.

Network Details (iSAM)

Either select the Layer parameter, the number of services, for each service the profile and CIR settings, or click on **More** for all settings.

The total bandwidth (when the **Performance Test** is enabled) and the estimated test duration are also displayed.

NAT LAN/WAN indicate presence of NAT (Network Address Translation) router. The NAT router is automatically detected and graphically displayed with LAN/WAN indication.

Note: *When there is a NAT at the Remote site, it is required to create UDP/TCP port 62819 forwarding rule on this NAT router to allow DTS communication. In addition, when there is a NAT in both directions (L->R and R->L), it is required to create port forwarding rules on the NAT router located at the Remote side for UDP port 7.*

From the **Test** menu, tap **Setup, Test Configurator**, and the **More** button from the **Network** block.

iSAM

- **Layer** is the layer used for all services. The layer is fixed to **L3/L4** when the **RFC 6349 Test** is enabled.
 - **L2** (default) for Ethernet II.
 - **L3/L4** for Ethernet II, IP (IPv4), and respectively UDP for the Configuration and Performance subtests, and TCP for RFC-6349 subtest.
- **Classification** defines the traffic classification used in the provider network: **VLAN ID**, **VLAN Priority**, or **DSCP** (available with layer L3/L4).

Note: *At least one check box (**Configuration Test**, or **Performance Test**, or **RFC 6349 Test**) has to be selected.*

- **Configuration Test** check box when selected (default) verifies if the network configuration is correct for each service before starting a long term test (Performance Test).

Set the **Configuration Test** duration in seconds per step enabled (CIR and CIR+EIR): 5 seconds (default) to 60 seconds.

- **Performance Test** check box when selected (default) verifies that the SLA parameters (FD, IFDV, and FLR) are met over time by running multiple services simultaneously. Results are measured and compared to the configured thresholds to declare the pass/fail verdicts. The **Performance Test** is only performed for services that have their **CIR** check box selected.

Set the **Performance Test** duration in hh:mm format: 1 minute to 24 hours (default is 10 minutes).

- **RFC 6349 Test on Service 1** check box when selected (cleared by default) verifies that the Ethernet service is able to properly carry TCP traffic; **Service 1** is used to performed the RFC 6349 test. Enabling the **RFC 6349 Test on Service 1** automatically set the operation mode to DTS and the layer to **L3/L4**; direction is bidirectional, max MTU is 1500 bytes, multiple connections as well as Path MTU Discovery are enabled.

Duration: The field next to the **RFC 6349 Test on Service 1** check box is used to set the duration of the TCP Throughput phase per direction in hh:mm format: 1 minute (default) to 24 hours.

Threshold (% of ideal) allows entering the TCP Throughput as a percentage of the Ideal L4 Throughput that will be used to declare the pass/fail verdict for both directions: **0** to **100** %; default is **95** %.

Test Setup - Test Configurator, Timer, and System

Network Details (iSAM)

Services

Allows the selection of the number of services: **1** (default) to **4**.

The following parameters are configurable individually for each service:

► Profile

Two profiles are defined by default as well as **User Profile**. Profiles are user definable and up to 25 profiles can be predefined (see *Customizable Profiles* on page 233).

Profile	Parameter				
	Frame Type	Frame Sizes	VLAN Priority	DSCP	Performance Criteria
Priority	EMIX	64, 128, 512, 1024, and 1518 ^a	7	CS7 ^b	MEF Metro High
Best Effort			0	CS0 ^b	MEF Metro Low

- a. The minimum frame size value is adjusted according to the frame structure and components selected as shown in the table of *Frame Size* on page 230.
- b. ECN is not present and not configurable but is set to 00 (Not-ECT).

Note: *At least one check box (**CIR** or **CIR+EIR**) has to be selected. Thus, clearing the CIR check box while CIR+EIR check box is cleared, will automatically select the CIR+EIR check box and vice versa.*

Note: *For Dual Test Set, the CIR and CIR+EIR values are the same (Symmetric) for both **L->R** and **R->L** directions.*

- **CIR** (Mbit/s) (Committed Information Rate) check box when selected (default) sets the service rate guaranteed by the SLA (default is **1 Mbit/s**).
- **CIR+EIR** (Mbit/s) check box when selected (cleared by default) sets the best effort allowed traffic for the service. The EIR (Excess Information Rate) value is equal to the CIR+EIR value minus CIR (default is 1.5 Mbit/s). The threshold value is configurable from the defined CIR value for this service to the line rate minus the total CIR from all services.
- **Frame Type** allows the selection of the frame type and frame size(s).
 - **Frame types** choices are: **Fixed** and **EMIX**.
 - Fixed** allows setting a single frame size.
 - EMIX** allows setting up to 8 EMIX frame sizes. The EMIX frame sequence is repeated until the test ends. Default are **64, 128, 512, 1024, and 1518**.
 - Quantity**, available with **EMIX**, allows selecting the number of EMIX frame sizes: 2 to 8 frames (default is **5**).

Test Setup - Test Configurator, Timer, and System

Network Details (iSAM)

➤ Frame Size

Type	Frame Size (bytes)
Fixed (default)	64 ^a (default) to 16000 ^b
EMIX	64 ^a to 16000 ^b

- The minimum value is adjusted according to the frame structure and components selected as shown in the following table.
- The maximum frame size is limited to 10000 for 10/100/1000Mbps electrical interface.

The following table lists each component that may affect the minimum frame size value.

Component	Description
C-VLAN	4 bytes
UDP	8 bytes
Ethernet Header	14 bytes
IPv4	20 bytes
Using DTS	4 bytes

Note: *Sending traffic with frame size > 1518 in switched network may result in losing these frames.*

► Classification

Allows the selection of the value for the selected classification:

Classification	Value
VLAN ID	0 through 4095 (default is 2). Refer to <i>VLAN ID and Priority</i> on page 758.
VLAN Priority	0 (default) to 7. Refer to <i>VLAN ID and Priority</i> on page 758.
DSCP	000000 (CS0) (default), 001000 (CS1), 010000 (CS2), 011000 (CS3), 100000 (CS4), 101000 (CS5), 110000 (CS6), 111000 (CS7), 001010 (AF11), 001100 (AF12), 001110 (AF13), 010010 (AF21), 010100 (AF22), 010110 (AF23), 011010 (AF31), 011100 (AF32), 011110 (AF33), 100010 (AF41), 100100 (AF42), 100110 (AF43), 101110 (EF), 110011 (51), 110110 (54).

Test Setup - Test Configurator, Timer, and System

Network Details (iSAM)

► Performance Criteria

The following performance criteria are available by default:

Name	≤ FD (ms)	≤ IFDV (ms)	≤ FLR (%)
MEF Metro High	10	3	0.01
MEF Metro Med	20	8	0.01
MEF Metro Low	37	Disabled	0.1
MEF Regional High	25	8	0.01
MEF Regional Med	75	40	0.01
MEF Regional Low	125	Disabled	0.1
MEF Continental High	77	10	0.025
MEF Continental Med	115	40	0.025
MEF Continental Low	230	Disabled	0.1
MEF Global High	230	32	0.05
MEF Global Med	250	40	0.05
MEF Global Low	390	Disabled	0.1

User Performance allows the configuration of the following values per service:

- **FD (Latency): 0.015 to 8000 ms** (default is **15 ms**).
- **IFDV (Jitter): 0.015 to 8000 ms** (default is **2 ms**).
- **FLR (Frame Loss): 0 to 5 %** (default is **0.1 %**).

Note: *The Performance Criteria list is user definable and up to 25 Performance criteria can be created (see Customizable Performance Criteria on page 235).*

Customizable Profiles

As previously mentioned, 2 profiles are available by default and up to 25 profiles can be predefined by editing the profile's text file (iSAMProfilesTemplate.ini) using a word processor like **Notepad**. The file is located under ProgramData\EXFO\ProtocolProducts\
Documents and Settings\All Users\Application Data\EXFO\ProtocolProducts\ depending on the operating system.

Example of profile's text file:

```
[Priority]
Frame Type = EMIX
Frame Size = 64, 128, 512, 1024, 1518
VLAN Priority = 7
DSCP = CS7
Performance Criteria = MEF Metro High

[Best Effort]
Frame Type = EMIX
Frame Size = 64, 128, 512, 1024, 1518
VLAN Priority = 0
DSCP = CS0
Performance Criteria = MEF Metro Low
```

Test Setup - Test Configurator, Timer, and System

Network Details (iSAM)

Each profile entry has the following parameters.

- **Profile Name:** 1 to 16 characters. All ASCII characters from 32 to 126 decimal are supported.
- **Frame Type:** Enter **Fixed** or **EMIX**. When the frame type is missing from a profile, **EMIX** is used.
- **Frame Size** (see *Frame Size* on page 230 for possible values); when the frame size is missing from a profile, default value(s) is used:
For **Fixed**: Enter a unique frame size.
For **EMIX**: Enter 2 to 8 frame sizes with a comma between each entry.
- **VLAN Priority**¹ (optional): Enter the priority number.
- **DSCP**¹ (optional): Enter either the DSCP name or its binary value.
- **Performance Criteria**¹: Enter the name of the performance criteria. When the **Performance Criteria** is missing from a profile or is not available from the user profile file, the **User Performance** criteria is used.

When a parameter is missing from a profile, the default value of the missing parameter is used.

The value of a parameter is validated to ensure it is within the supported range; otherwise the profile entry is unsupported.

If the profile file contain more than 25 profiles, only the first 25 valid profiles are retained.

1. See *Classification* on page 231 for possible values.

Customizable Performance Criteria

As previously mentioned, factory performance criteria are available and up to 25 performance criteria can be defined by editing the performance criteria text file (iSAMPerformanceCriteriaTemplate.ini) using a word processor application like **Notepad**. The file is located under

ProgramData\EXFO\ProtocolProducts\ or

Documents and Settings\All Users\Application Data\EXFO\ProtocolProducts\ depending on the operating system.

Example of performance criteria's text file:

```
[MEF Metro High]
```

```
FD = 10
```

```
IFDV = 3
```

```
FLR = 0.01
```

```
[MEF Metro Med]
```

```
FD = 20
```

```
IFDV = 8
```

```
FLR = 0.01
```

```
[MEF Metro Low]
```

```
FD = 37
```

```
IFDV =
```

```
FLR = 0.1
```

Each profile entry has the following parameters:

- Performance Criteria Name: 1 to 16 characters. All ASCII characters from 32 to 126 decimal are supported.
- Frame Delay (FD) Threshold: 0.015 ms to 8000 ms.
- Inter-Frame Delay (IFDV) Threshold: 0.015 ms to 8000 ms.
- Frame Loss Ratio (FLR) Threshold: 0 % to 5 %.

Test Setup - Test Configurator, Timer, and System

Network Details (iSAM)

If the threshold value for a parameter is not defined, it is considered as disabled (as in the example above for IFDV =).

The value of a parameter is validated to ensure it is within the supported range; otherwise the performance criteria entry is unsupported.

ODU Channels - Global

From the **Test** menu, tap **Setup**, **Test Configurator**, tap on the test block (**ODU Channels**), and on the **Global** tab.

Note: *The ODU channels global configuration applies to all channels.*

Pattern

The test pattern icon next to the **Pattern** label indicates the status of the received pattern signal. Refer to *Status Bar* on page 28 for more information.

- **No Pattern Analysis (Live)** check box when cleared (default), monitors the received traffic pattern. For live traffic, the **No Pattern Analysis (Live)** check box should be selected as the traffic is a live pattern thus there is no analysis of pattern loss and bit error.
- **Pattern** sets the test pattern that will be generated: **PRBS31** (default) or **NULL Client** (0000).
- **Invert** check box, when selected (cleared by default), inverts the test pattern meaning that every 0 will be changed for 1 and every 1 for 0. For example, the pattern 1100 will be sent as 0011.

Bit Error

- **Pass/Fail Verdict** allows enabling bit-error-rate pass/fail verdict by selecting either **Bit Error Count** or **Bit Error Rate**. The default value is **Disabled**.
- **BER Threshold** allows entering the threshold **Count** or **Rate** value that will be used to declare the pass/fail verdict.

For **Count**, enter the maximum bit error count allowed before declaring a fail verdict: **0** (default) to **999999**.

For **Rate**, enter the maximum bit error rate allowed before declaring a fail verdict: **1.0E-14** to **1.9E-01**. The default value is **1.0E-12**.

Service Disruption

The Service Disruption Time (SDT) corresponds to the duration associated to a defect that occurred in the network. For example a disruption that occurs during a network switching from the active channels to the backup channels or vice versa.

- **Disruption Monitoring** check box when selected (disabled by default) enables the disruption time measurements. However, the measurement will only start if the test is already started, or when the test is started.

Note: *Clearing the **Disruption Monitoring** check box will stop the measurement without clearing the results. The disruption monitoring is automatically stopped without clearing results when the test is stopped. However, starting the test again while the **Disruption Monitoring** check box is selected will reset the results before restarting.*

Note: *The service disruption measurements are cleared when changing the criteria.*

- **Defect** allows choosing on which layer and defect the service disruption time test will be performed. Choices depend on the selected test path.

Layer	Defect
ODUK	LOFLOM, AIS, OCI, LCK, BDI, BIP-8, BEI
OPUK	AIS, CSF

Note: *The Service Disruption Time measurement supports a parent defect approach where the SDT measurement is triggered when the selected defect or a higher defect in the signal structure hierarchy is detected.*

- **No Defect Time (ms)** represents the period without any defects before stopping SDT measurement: **0.005 ms to 2000 ms** (default is **300 ms**).
- **Pass/Fail Verdict** check box when selected (cleared by default) enables service disruption pass/fail verdict and allows setting the threshold value.
- **SDT Threshold (ms)** allows entering the SDT threshold value that will be used to declare the pass/fail verdict: **0.001 to 299999.999 ms** (default is **50 ms**).

Channel Summary

- **Channel ID / Type** table indicates each channel number with its ODU mapping type.
- **Payload Type** indicates the mapped ODU payload type.
- **Quantity of Channels** indicates the number of channels part of the test.
- **Unused Capacity** indicates the number of tributary slot not used; either configured as background traffic or Unallocated.
- **Modify Trib Slots/Channels**
 - **Channel ID** selects a channel number highlighting the tributary slots composing this channel. Alternatively, selecting a channel from the table on the right (**TX**, **RX**, or **TX = RX** tab) also selects a channel number.
 - **Tributary Port** indicates the tributary port number associated to the channel number.
 - **Payload Type** indicates the payload type for the mapped OPU.
 - **RX**, **TX**, or **TX = RX** tab (table on the right) displays the tributary slot assignments per channel for either RX, TX, or both RX and TX (TX=RX) and allows selecting tributary slots to be assigned/unassigned; see **Assign/Unassign/Mode** for more information.

Each tributary slot displays its number (left top corner) and channel number (middle); the channel number is replaced by **B** or **U** indicating respectively if the tributary slot carries background traffic or is configured as Unallocated.

The following table indicates the number of tributary slots per channel:

For...	Mapped into...	Tributary slot per channel
ODU3	OPU4	31
ODU2	OPU4	8
ODU1	OPU4	2
ODU0	OPU4	1

The table provides a status for each channel using visual indication as follows:

Background Color	Description
White	Tributary slot using background traffic (B) or Unallocated (U).
Orange	Tributary slot(s) assigned for the selected channel.
Gray	Tributary slot(s) assigned.

- **TX = RX** check box, when selected, allows using the same tributary slot configuration for both TX and RX.
- **RX Structure Match** is a live status indicating if the tributary slot/channel configuration is matching the received signal. Only configured channels are considered during the validation. **RX Structure Match** is displayed using different background colors as follows:

Background Color	Description
Green	Configured structure is matching the received signal.

Test Setup - Test Configurator, Timer, and System

ODU Channels - Global

Background Color	Description
Red	Configured structure is not matching the MSI received signal or could contain an unsupported mapping (for example Unallocated).
Gray	Impaired signal is preventing RX structure decoding (for example when a LOS alarm is detected).

► Channel Assignment Status

The table provides a list of each channel ID, its ODU type, and the TX/RX assignment status. TX/RX indicates either **Assigned** when all tributary slot are selected for this channel or the number of assigned tributary slot over the total number of tributary slots for this channel. TX/RX status must be **Assigned** for all channels in order to complete the tributary slots/channels configuration. Channel are sorted by their ascending ID by default, it is possible to sort ascending/descending and by **Type**, **RX**, or **TX** column by clicking in the desired column title.

Note: *ODU0 type mapping is selected by default for all channels when the test is created. To change the ODU type mapping, use the **Del Ch** or **Delete All** button then use the **Add Ch** button to select an other ODU type.*

- **Edit Ch ID** button selects a new channel ID from available list.
- **Add Ch** button allows adding new channels.

Channel ID is the channel ID to be added. Subsequent channel ID are selected then assigned, skipping channel ID already assigned, when adding more than one channel at once.

ODU Type is the ODU mapping type: **ODU0**, **ODU1**, **ODU2**, or **ODU3**. It is possible to have different ODU types when the OTN-MIX-MAPPING software option is enabled; otherwise all channels must have the same ODU type.

Quantity is the number of channel to be added.

- **Del Ch** button removes the selected channel.
- **Delete All** button removes all channels.
- **Assign / Unassign / Mode**

To assign or unassign tributary slots:

- 1.** From the **Channel Assignment Status** table, select a channel.
- 2.** Select either **Assign** or **Unassign**.
- 3.** From the tributary slot matrix on the right, select a tributary slot; tributary slots are assigned/unassigned as follows according to the selected **Mode**:

Mode	Description
Tributary Slot	Assigns/unassigns a single tributary slot.
Channel	Assigns/unassigns all tributary slots for a specific channel. After selecting a first tributary slot, subsequent tributary slots are automatically assigned/unassigned if the channel contains more than one tributary slot.
All Channels	Assigns/unassigns all tributary slots to/from a channel and this is repeated for all channels. After selecting the first tributary slot, subsequent tributary slots are automatically assigned/unassigned if the channel contains more than one tributary slot. This is repeated for all channels in order.

Test Setup - Test Configurator, Timer, and System

ODU Channels - Global

- **Copy RX MSI** allows automatic configuration of the Channel to Trib Slot that matches the system under test configuration. A warning message is displayed when the RX test structure is either:

Unsupported: An unsupported ODU channel is received (for example Unallocated). The unsupported ODU channels are configured as background traffic.

Invalid: Impaired signal is preventing RX structure decoding (for example when a LOS alarm is detected). The RX MSI structure cannot be copied.





Restore Multi-Channel OTN Defaults

Reverts the current test application to its default factory settings.

Optical Device Under Test (iOptics)

From the **Test** menu, tap **Setup**, and **Test Configurator**.

- **Transceiver selection:** Tap on a transceiver icon to select the interface/port. The selected transceiver is highlighted with an amber contour. The selected transceiver type and its status are displayed.

Status	Description
	Validating the transceiver.
	Transceiver correctly detected.
	Incompatible transceiver detected.
	Missing transceiver/adapter.

- **Rate:** Once the transceiver is correctly detected , select the interface rate. Rates depend on the selected port, the inserted transceiver, and the rates supported on the module.

Transceiver	Rate			
	Transport	Ethernet	Fibre Channel	Wireless
CFP8	-	400GE (8 Lanes)	-	-
CFP4, QSFP28	OTU4 (4 Lanes)	100GE (4 Lanes)	-	-
QSFP+	OTU3e2 (4 Lanes) OTU3e1 (4 Lanes) OTU3 (4 Lanes)	40GE (4 Lanes)	-	-

Test Setup - Test Configurator, Timer, and System

Optical Device Under Test (iOptics)

Transceiver	Rate			
	Transport	Ethernet	Fibre Channel	Wireless
SFP+	OTU2	10GE WAN	1X	CPRI - 1.2G
SFP/SFP+ (Port 1 only)	OTU1e	10GE LAN	2X	CPRI - 2.4G
	OTU2e	1GE Optical	4X	CPRI - 3.1G
	OTU1f	100M Optical	8X	CPRI - 4.9G
	OTU2f		10X	CPRI - 6.1G
	OTU1		16X	CPRI - 9.8G
	OC-192/STM-64			OBSAI- 1.5G
	OC-48/STM-16			OBSAI - 3.1G
	OC-12/STM-4			OBSAI - 6.1G
	OC-3/STM-1			
	OC-1/STM-0			

- **Vendor Name, Part Number, Serial Number, Connector Type, and Mode** are information retrieved from the transceiver (see page 247).

- **More** gives additional transceiver information and settings.
 - **Parameters** are retrieved from the transceiver:

Parameter	CFP4	CFP8	QSFP	SFP SFP+
Module ID	X	X	X	X
Vendor Name	X	X	X	X
Part Number	X	X	X	X
Serial Number	X	X	X	X
Hardware Revision	X	X	X	X
Firmware Version	X	X	-	-
Adaptor Revision	-	-	-	-
Revision Compliance	-	-	X	-
Connector Type	X	X	X	X
Speed	X	X	X	X
Type/Compliance Code	X	X	X	X
Wavelength	-	-	-	X
Mode	X	X	X	X
Power Class	X	X	X	X
Lane Ratio Type	X	-	-	-
Host Lane Signal Spec	-	X	-	-
WDM Type	X	X	-	-
Signal Code - Modulation	-	X	-	-
Signal Code - Coding	-	X	-	-
CLEI Code	X	X	X	-

- **Lasers OFF at Start-Up** allows turning off all lasers automatically when starting the module or when switching from one test application to another. This check box is cleared by default.

Remote Details (iSAM)

The remote block automatically scans the remote modules for **DTS** and **Remote Loopback** modes and allows the selection of the remote module that is used to loop back the traffic via **Smart Loopback** or EtherSAM in **Dual Test Set (DTS)** mode for simultaneous bidirectional results. The number module available for remote connection is displayed. If the connection with the remote module is not manually established, the remote connection process is automatically performed when starting the test.

From the **Test** menu, tap **Setup, Test Configurator**, and the **More** button from the **Remote** block.

Note: *Not available with **Manual Loopback** remote operation mode.*

For both DTS and Remote Loopback Operation Modes

► Discovered Remotes

The modules are discovered dynamically and listed with their **Name**, **IP** address, **Status**, **Connection**, and **Preferred** information. **Name** and **Status** are only available for remote 88000 Series, and 85100G modules. Only modules from the same subnet are automatically discovered. To access a module from a different subnet, use the **Add** button.

- **Preferred** check box when selected indicates that this module is part of the preferred module's list. Preferred remote modules will be considered first during the automatic connection process as follows:

Priority	Preferred or not	Status
1	Preferred	Available
2		Taken
3		Test in Progress
4	Non Preferred	Available
5		Taken
6		Test in Progress

- **Status**

Background Color	Status	Description
Green	Ready	Connected with the local unit
	Running	
Yellow	Taken	Connected with another unit
Red	Test in Progress	Test in progress with another unit
No color	Unreachable	Preferred remote does not reply
	Available	Not connected

- **Connection** indicates **Connected** when the local unit is connected to a remote module.
- **Add** button is used to add a preferred remote module to the preferred list. Enter the IP address of the remote module and tap **OK**. This is useful to access a module from a different subnet.

For Remote Loopback Operation Mode

- **Loop-Up** button establishes the connection with the selected remote module and sets the remote module into **Smart Loopback** test application.

Following a successful loop-up, the IP address of the remote module will be used as the destination IP address for the test.

- **Overtake** button manually establishes the connection with the remote module and set the remote module into Smart Loopback test application. Available when the status is **Taken** or **Test in Progress** with another unit. A confirmation is required to overtake a module.
- **Loop-Down** button ends the connection between the local and the remote modules.

For DTS Operation Mode

- **Connect** button manually establishes the connection with the selected remote module and sets the remote module into DTS EtherSAM test application.

Following a successful connection, the IP address of the remote module will be used as the destination IP address for the test.

- **Overtake** button manually establishes the connection with the remote module and set the remote module into DTS EtherSAM test application. Available when the status is **Taken** or **Test in Progress** with another unit. A confirmation is required to overtake a module.

Following a successful connection, the IP address of the remote module will be used as the destination IP address for the test.

- **Disconnect** button, available once the connection with the remote module is established, terminates the connection with the remote module. Available when the status is **Ready**.

For Manual Loopback Operation Mode

- **MAC**, available with layer L2, allows entering the destination MAC address of the remote.
- **IP**, available with L3/L4, allows entering the destination IP address of the remote.
- Resolved MAC address status, available with L3/L4, indicates:
 - **Resolving** when the ARP process is resolving.
 - **Resolved** when the ARP process is resolved.
 - **Failed** when the ARP process failed.
- **Quick Ping**, available with layer L3/L4, tests if the destination IP address can be reached. A message displays if the ping attempt is **Successful** or **Failed**.

RFC 2544 - Global

From the **Test** menu, tap **Setup**, **Test Configurator**, tap on the RFC 2544 block, and on the **Global** tab.

Dual Test Set

- **Dual Test Set (DTS)** check box when selected (cleared by default) enables RFC 2544 **Dual Test Set**. Once **Dual Test Set** is enabled, use the **Discover Remote** button to select a remote unit. Not available in **Dual Port** topology.

Note: *It is also possible using the Discover Remote button to connect to a remote module and automatically enable **Dual Test Set**. For more details, refer to Discover Remote Button on page 636.*

- **Disconnected** indicates that there is no connection established with a remote module.
- **Connected** indicates that the connection is established with a remote module.
- **Discover Remote** button allows discovering remote modules supporting **Remote Loopback** and/or **Dual Test Set**. For more details, refer to *Discover Remote Button* on page 636.

Global Options

- **Flow Direction** allows the selection of the traffic direction as follows:
 - **TX to RX** for **Single Port** topology.
 - **Port #1 to Port P2, Port #2 to Port #1**, and **Bidirectional** for **Dual Port** topology.
 - **Local to Remote, Remote to Local**, and **Bidirectional** for **Dual Test Set**.
- **Rate Unit** determines the unit used to display the rate values: %, **Mbit/s**, or **Gbit/s**.
- **Pass/Fail Verdict** check box when selected (default) enables the use of the pass/fail verdict.

Subtests and Estimated Time

- **Subtests** allows enabling the **Throughput, Back-to-Back, Frame Loss**, and **Latency** subtests individually.
- **Estimated Time (H:MM)** indicates the estimated time required to complete each subtest at best conditions. The total estimated time to complete all subtests is also displayed.

Frame Distribution

- **Frame Distribution** allows selecting either **RFC 2544** (default) or **User Defined** distribution.
- **Quantity** is only available when **User Defined** is selected and allows selecting the number of frames, from **1** to **7** (default), in the distribution.

Test Setup - Test Configurator, Timer, and System

RFC 2544 - Global

- **Frame Size (Bytes):** For **RFC 2544** distribution, gives predefined frame size distribution values. For **User Defined** distribution, enter up to seven frame size values.

Distribution	Frame Size
RFC 2544	64 ^a , 128, 256, 512, 1024, 1280, and 1518
User Defined	64 ^a to 16000 ^b

- The minimum frame size will be adjusted according to the frame structure and components selected.
- The maximum frame size is limited to 10000 for 10/100/1000Mbps electrical interface.

The following table lists each component that may affect the minimum size value.

Component	Description
VLAN	4 bytes per VLAN tag (up to 3 VLAN tags)
LLC and SNAP Headers	8 bytes
IPv4	20 bytes
IPv6	40 bytes
Using DTS	4 bytes

Restore RFC 2544 Defaults

Reverts the configured parameters to their default values.

RFC 2544 - Subtests

From the **Test** menu, tap **Setup**, **Test Configurator**, tap on the RFC 2544 block. and on the **Subtests** tab.

Allows the configuration of each enabled subtest.

Throughput

The objective of this test is to find the throughput of the device under test for which there is no frame loss. Starting at the specified maximum rate (**Max. Rate**), the rate converges towards the highest throughput without frame loss. The search is done with a halving/doubling method until a final value is reached. The test performs the number of trials defined (**Trials**). The throughput measurement is validated the number of times specified (**Validations**) for the predefined duration (**Trial Duration**). The **Accuracy** and **Acceptable Errors** specify how precise the result must be. The test is performed for each defined frame size.

Test Setup - Test Configurator, Timer, and System

RFC 2544 - Subtests

- **Max. Rate** is the maximum rate the test should begin with, in terms of a percentage of the line rate (%), **Mbit/s**, or **Gbit/s**. For **Dual Test Set** Max. Rate is configurable for both local to remote (**L->R**) and remote to local (**R->L**) directions. For **Dual Port** topology, Max. Rate is configurable for both P1 to P2 (**P1->P2**) and P2 to P1 (**P2->P1**) directions.

Interface Speed	%	Max. Rate	
		Mbit/s	Gbit/s
10 Mbit/s	0.0050 to 100.0000 ^a	0.00001 to 10.000 ^a	Not Applicable
100 Mbit/s	0.0050 to 100.0000 ^a	0.0001 to 100.000 ^a	Not Applicable
1000 Mbit/s	0.0050 to 100.0000 ^a	0.001 to 1000.00 ^a	0.000001 to 1.000 ^a
10G LAN	0.0050 to 100.0000 ^a	0.01 to 10000.000 ^a	0.00001 to 10.000 ^a
10G WAN ^b	0.0005 to 92.8571 ^a	0.01 to 9285.71 ^a	0.00001 to 9.28571 ^a
40G	0.0050 to 100.0000 ^a	0.1 to 40000.0 ^a	0.0001 to 40.0000 ^a
100G	0.0050 to 100.0000 ^a	0.1 to 100000.0 ^a	0.0001 to 100.0000 ^a

a. Default value.

b. The maximum value for 10G WAN may be lower depending on the frame size. The maximum value will be adjusted for each frame size.

- **Trial Duration** is the time for each trial in minutes:seconds: **1** second (default) to **30** minutes.
- **Trials** is the number of times the throughput test will be generated: **1** (default) to **50** trials.

- **Accuracy** is the accuracy measurement in percentage of the line rate (%), **Mbit/s**, or in **Gbit/s**. The accuracy is not based on the configured **Maximum Rate** but on the Ethernet line rate. The accepted values are as follows:

Interface Speed	Max. Rate		
	%	Mbit/s	Gbit/s
10 Mbit/s	0.1 to 10.0 (default 1.0)	0.01 to 1.0 (default 0.10)	Not Applicable
100 Mbit/s	0.1 to 10.0 (default 1.0)	0.1 to 10.0 (default 1.0)	Not Applicable
1000 Mbit/s	0.1 to 10.0 (default 1.0)	1 to 100.0 (default 10)	0.001 to 0.100 (default 0.010)
10G LAN	0.1 to 10.0 (default 1.0)	10.0 to 1000.0 (default 100)	0.01 to 1.00 (default 0.10)
10G WAN	0.1 to 10.0 (default 1.0)	10.0 to 1000.0 (default 100.00)	0.01 to 1.00 (default 0.1)
40G	0.1 to 10.0 (default 1.0)	40.0 to 4000.0 (default 400.0)	0.04 to 4.00 (default 0.40)
100G	0.1 to 10.0 (default 1.0)	100.0 to 10000.0 (default 1000.0)	0.10 to 10.00 (default 1.0000)

- **Acceptable Errors** represents the number of acceptable errors for the test: **0** (default) to **10**.
- **Validations** represents the number of times the result should be validated: **1** (default) to **50** times.

Back-to-Back

The objective of this test is to find the maximum number of frames that can be sent at maximum throughput without frame loss. A burst of frames (**Burst Time**) is sent with minimum inter-frame gaps to the device under test and the number of forwarded frames is counted. If the count of transmitted frames is equal to the number of forwarded frames, the length of the burst is increased and the test is rerun. If the number of forwarded frames is less than the number of transmitted frames, the length of the burst is reduced and the test is rerun. The Back-to-Back value is the number of frames in the longest burst that the Device Under Test (DUT) can handle without the loss of any frames. The test performs the number of defined trials (**Trials**). The **Accuracy** and **Acceptable Errors** settings specify how precise that result must be. The test is performed for each defined frame size.

- **Burst Time** is expressed in seconds: **1** (default) to **5** seconds.
- **Trials** represents the number of times the Back-to-Back test will be generated: **1** (default) to **100** trials.
- **Accuracy (Frames)** is the accuracy measurement value in frames: **1** (default) to **50** frames.
- **Acceptable Errors** represents the number of acceptable errors for the test: **0** (default) to **10**.
- **Bursts** represents the number of burst that will be generated: **1** (default) to **10**.

Frame Loss Configuration

The objective of this test is to find the percentage of frames that are lost due to lack of resources. Starting at the specified maximum rate (**Max. Rate**), the test is performed for a specific frame size and for the specified duration (**Trial Duration**). The test is repeated by decreasing the rate by the specified granularity (**Granularity**), then the test is repeated again until there are two successive trials in which no frames are lost. The test is performed for the defined number of trials (**Trials**). The test is performed for each defined frame size.

- **Max. Rate** is the maximum rate the test should begin with, in terms of a percentage of the line rate (%), **Mbit/s**, or **Gbit/s**. The accepted values are as shown in the Max. Rate table on page 256. For **Dual Test Set**, **Max. Rate** is configurable for both local to remote (**L->R**) and remote to local (**R->L**) directions. For **Dual Port** topology, Max. Rate is configurable for both P1 to P2 (**P1->P2**) and P2 to P1 (**P2->P1**) directions.
- **Trial Duration** represents the time value for each trial in minutes:seconds: **1** second to **30** minutes (default is **00:01**).
- **Trials** represents the number of times the test will be generated: **1** (default) to **50** trials.
- **Granularity** corresponds to the percentage interval between each throughput value used for the test: 1 % to 10 % (RFC) - (default). For example, 10 % granularity means that the test will be performed for 100 %, 90 %, 80 %... of the rate value.

Latency Configuration

The objective of the test is to measure the time required for the frame to go through the device under test and return back to source. Starting by sending a stream of frames for the predefined duration (**Trial Duration**) and throughput (**Max. Rate**) at a particular frame size, an identifying dependent tag is included in one frame. The time at which this frame is transmitted is recorded (**timestamp A**). When the tagged frame comes back, the time is recorded again (**timestamp B**) and the Latency result is: **timestamp B - timestamp A**. The test is repeated for the defined number of times (**Trials**) and the average result is calculated. The test is performed for each defined frame size.

- **Trial Duration** represents the time value for each trial in “minutes:seconds”: **1** second (default) to **2** minutes.
- **Trials** represents the number of times the test will be generated: **1** (default) to **50** trials.
- **Copy From Throughput** check box, when selected (default), uses the Throughput subtest results max rate value for each corresponding frame size. When the check box is cleared, it is possible to set the **Max. Rate** by tapping on the **Config. per Frame Size** button.
- **Margin %**, available when **Copy From Throughput** check box is selected, decreases the max rate value(s) from the Throughput subtest by a value corresponding to the percentage of the line rate specified: **0** (default) to **10** percent.

- **Measurement Mode**, available with **Dual Test Set** for rates from 10M to 10GE, allows the selection of the latency measurement mode: **Round-Trip** (default) or **One-Way**.

Synchronization with an external 1PPS clock is required to perform One-Way Latency measurement. One-Way Latency is only possible when both the local and remote 1PPS signal clocks are valid. The following alarms are available with One-Way Latency measurement mode.

LOPPS-L and **LOPPS-R** (Loss Of Pulse Per Second - Local/Remote) are declared when either no pulse is received or when no pulse is received within 1 second $\pm 6.6 \mu s$ after the previous pulse. LOPPS-R is only monitored once the DTS connection is established.

- **Config. per Frame Size** is available when the **Copy From Throughput** check box is cleared and allows setting the **Max. Rate** for each frame size. For **Dual Test Set** the **Max. Rate** is configurable for both local to remote (**L->R**) and remote to local (**R->L**) directions. For **Dual Port topology**, *Max Rate is configurable for P1 to P2 (P1->P2) and P2 to P1 (P2->P1) directions.*

All Frames check box when selected (cleared by default) allows entering the maximum rate that will be applied to all frame sizes.

Thresholds Button

Note: For *Dual Test Set*, thresholds are configurable for **Local to Remote** and **Remote to Local** directions at the exception of Round-Trip Latency Threshold for which the value is unique. For **Dual Port** topology, thresholds are configurable for P1 to P2 (P1->P2) and P2 to P1 (P2->P1) directions.

- **Throughput Threshold** sets the threshold¹ value used to declare a pass/fail verdict and it applies to all frame sizes when applicable. The range is as follows:

Interface Speed	%	Max. Rate	
		Mbit/s	Gbit/s
10 Mbit/s	0.000 to 100.000 ^a	0.000 - 10.000 ^a	Not Applicable
100 Mbit/s	0.000 to 100.000 ^a	0.000 - 100.000 ^a	Not Applicable
1000 Mbit/s	0.000 to 100.000 ^a	0.000 - 1000.000 ^a	0.000 - 1.000 ^a
10G LAN	0.000 to 100.000 ^a	0.000 - 10000.000 ^a	0.000 - 10.000 ^a
10G WAN ^b	0.000 to 92.8571 ^a	0.000 - 9230.769 ^a	0.000 - 9.230 ^a
40G	0.000 to 100.000 ^a	0.000 - 40000.000 ^a	0.000 - 40.000 ^a
100G	0.000 to 100.000 ^a	0.000 - 100000.000 ^a	0.000 - 100.000 ^a

- a. Default value.
- b. The maximum value for 10G WAN may be lower depending on the frame size. The maximum value will be adjusted for each frame size.

- **Back-to-Back Threshold** sets the threshold¹ value in percentage of frames per burst to declare a pass/fail verdict. The range is from **0.0** to **100.0** (default) percent and it applies to all frames sizes when applicable.

1. The verdict is PASS when the received/measured value is greater or equal to the threshold value.

- **Frame Loss Threshold (%)** sets the threshold¹ value of frame loss. The range is from **0.000** to **100.000** (default is **0.100**) and it applies to all frame sizes when applicable.
- **Latency Threshold / Round-Trip Latency Threshold** sets the threshold value as the maximum delay in **ms** or **μs**. The range is from **0.5** to **8000.0 ms** (default is **125.0 ms**) and it applies to all frame sizes when applicable. For **Dual Test Set**, only available with **Round-Trip Latency Measurement Mode** (see *Latency Configuration* on page 260).
- **One-Way Latency Threshold**, available for **Dual Test Set** with **One-Way Latency Measurement Mode** (see *Latency Configuration* on page 260), sets the maximum one-way latency value in millisecond, allowed for all frame sizes: **0.005** to **500 ms** (default is **125 ms**).
- **Latency Unit** allows selecting either **ms** or **μs** as the reference unit for the **Latency Threshold**.

1. The verdict is PASS when the received/measured value is lower or equal to the threshold value.

RFC 6349

From the **Test** menu, tap **Setup, Test Configurator**, and the RFC 6349 block.

Connection

- **Operation Mode** allows the selection of the test operation mode: **Dual Test Set (DTS)** or **EXFO|Worx Interop**.

The connection is graphically displayed with its status as follows:

Operation Mode	Status	Description
Dual Test Set	Disconnected	No connection established with a remote module.
	NAT LAN/WAN, WAN IP	<p>Connection established with a remote module.</p> <p>NAT LAN/WAN and WAN IP indicate presence of NAT (Network Address Translation) router. The NAT router is automatically detected and graphically displayed with LAN/WAN indication as well as the WAN IP address when the Power Blazer is behind a NAT router.</p> <p>When there is a NAT at the Remote site, it is required to create the following rules on this NAT router:</p> <ol style="list-style-type: none"> 1- for UDP/TCP port 62819 to allow DTS communication. 2- for the defined TCP port (see TCP Port on page 265).
EXFO Worx Interop	Disconnected	Verifier not detected (not reachable, invalid IP, or invalid TCP port).
	Ready or Running	<p>Verifier detected, either running (remote unit locked) or ready to perform a test.</p> <p>The detection of NAT (Network Address Translation) router presence is automatically detected and graphically displayed. The WAN IP address is also displayed when the module is behind a NAT router.</p>
	Busy	Verifier busy with another client (locked).

- **Discover Remote** button, available with **Dual Test Set**, allows discovering remote modules supporting **Dual Test Set**. For more details, refer to *Discover Remote Button* on page 636.
- **Direction** allows the selection of the traffic direction: **Local to Remote**, **Remote to Local**, and **Bidirectional** (default).
- **Remote IP Address**, available with **EXFO|Worx Interop**, is either the remote IP address of the verifier or the WAN IP address when the verifier is behind a NAT router.
- **TCP Port** is the port used by the server located at the remote side: **1 to 65535** (excluding **62819** that is used for DTS connection), default is **50201**. The port forwarding rule for the defined TCP port must be created on the NAT router when the remote is behind a NAT.

Parameters

- **Multiple Connections** check box when selected (default) indicates that the applicable TCP Throughput phases are performed with multiple connections; otherwise TCP Throughput phases are performed within a single connection. For 40/100GE rate, this check box is selected and the **Window Size Target per Connection** can be used to set the target window.
- **Window Size Target per Connection**, available for 40/100GE rate, selects the target window per connection: 1 MiB, 4 MiB, 8 MiB, 16 MiB (default), and 32 MiB.
- **CIR**

The Local-to-Remote CIR and Remote-to-Local CIR represent the Committed Information Rate of the Ethernet Service under test: **1.0 Mbit/s** to Line Rate. The CIR is not used to actually transmit frames at this rate but to calculate a Bandwidth Delay Product (BDP) which in turn is used to set the Max Window Size of the TCP connections.

Rate Unit determines the unit used to display the rate values: **Mbit/s** (default) or **Gbit/s**.

- **TOS/DS (IPv4)** allows entering an hexadecimal value, **00** (default) to **FF**. Changing the **IP TOS/DS** value will affect the **TOS/DS Config** settings and vice versa.

MTU

- **Max MTU (bytes)** determines the Maximum Transfer Unit (MTU) to use when the client is generating TCP traffic toward the server: from **1080** to **1500** bytes (default).
- **Path MTU Discovery** check box when selected (default) allows performing a Packetization Layer Path MTU Discovery phase.

Window Sweep

- **Window Sweep** check box when selected (default) allows performing the Window Sweep phase.
- **Duration (per step)** is the duration of the Window Sweep phase per direction and per Window tested: 30 seconds (default) to 5 minutes.

TCP Throughput

- **Duration** is the duration of the TCP Throughput phase per direction: 1 minute (default) to 30 days.
- **Pass/Fail Verdict** check box when selected (default) enables the use of the pass/fail verdict.
- **Threshold (% of ideal)** allows entering the TCP Throughput as a percentage of the Ideal L4 Throughput that will be used to declare the pass/fail verdict for both directions: **0** to **100** %; default is 95 %.

Restore RFC 6349 Defaults

Reverts the configured parameters to their default values.

S-OAM and MPLS-TP OAM

From the test menu, tap **Setup, Test Configurator**, and the **S-OAM (Y.1731/802.1ag/MEF)** or **MPLS-TP OAM (G.8113.1)** test block.

OAM Mode

Allows the selection of the OAM mode.

OAM Type	OAM Mode
S-OAM	Y.1731 (default) supports both Connectivity Fault Management and Performance Monitoring which includes all S-OAM functions supported by this module.
	802.1ag supports Connectivity Fault Management including only the Continuity Check, Loopback, Link Trace, and RDI functions.
	MEF supports both Connectivity Fault Management and Performance Monitoring which includes all S-OAM functions supported by this module.
MPLS-TP OAM	G.8113.1 (default) supports both Connectivity Fault Management and Performance Monitoring which includes all MPLS-TP OAM functions supported by this module.

S-OAM and MPLS-TP OAM Responder

S-OAM Responder or **MPLS-TP OAM Responder** check box when selected (default) allows responding to LBM, LTM, DMM, LMM, and SLM valid messages (test running or not). LTM and SLM are only available with Ethernet OAM. Traffic statistics are also monitored (refer to *Responder* on page 535).

For S-OAM: A valid message must have its source MAC address matching the Peer MEP MAC address, destination MAC address matching either the unit port Unicast MAC address or a Multicast class 1 address, VLANs matching the unit port VLANs, and MEG/MD Level matching the local MEG/MD Level. Refer to *Unicast/Multicast Addresses for Ethernet OAM* on page 757 for more information.

For MPLS-TP OAM: A valid message must have its: destination MAC address matching either the unit MAC address, FF:FF:FF:FF:FF:FF, or 01:00:5E:90:00:00; VLANs matching the unit port VLANs; MPL Labels matching the local MPLS Label Stack configuration, including GAL; MEG Level matches the local MEG Level. For the Loopback function, a valid message must also have its: MEP ID of the target MEP ID TLV matching the Local MEP ID or ID Sub-Type is 0x00 (Discovery); and MEP ID and MEG ID of the requesting MEP ID TVL, if present, matching respectively the Peer MEP ID and the Local MEG ID.

Respond to... message	Respond with... message
LBM	LBR
LTM ^a	LTR
DMM	DMR
LMM	LMR
SLM ^a	SLR

a. Only available with Ethernet OAM.

Pass/Fail Verdict

Pass/Fail Verdict check box when selected (default) enables the use of the pass/fail verdict. A global fail verdict is declared when any of the following condition is met: **Link Down** alarm, **Loss Continuity** alarm, or any fail verdict for **Frame Delay**, **Frame Loss**, **Synthetic Loss** (Only applicable to Ethernet OAM), **Frame Delay Failure**, **Frame Loss Failure**, **Synthetic Loss Failure** (Only applicable to Ethernet OAM), **Loopback Failure**, or **Test Failure**.

Thresholds

Available with G.8113.1, Y.1731 and MEF OAM Modes when Pass/Fail verdict is enabled. The verdict is PASS when the measured value is lower or equal to the threshold value.

- **Frame Delay Threshold (ms)** allows setting the threshold value of frame delay: **0.001** to **8000** ms (default is **50** ms).
- **Frame Loss Threshold (%)** allows setting the threshold value of frame loss: **0.001** to **100** % (default is **10** %).
- **Synthetic Loss Threshold (%)**, available with Ethernet OAM (Y.1731 and MEF), allows setting the threshold value of Synthetic Loss: **0.001** to **100** % (default is **10** %).

Next HOP Router (G.8113.1)

- **MAC Address**, available when **Resolve MAC** check box is cleared, allows entering the Next HOP Router MAC address: 00:00:00:00:00:00 to FF:FF:FF:FF:FF:FF, default is 01:00:5E:90:00:00. The MAC Address 01:00:5E:90:00:00 is reserved for point-to-point link and can be used when the unicast address is unknown (as per RFC-7213).
- **Resolve MAC** check box, when selected (cleared by default), sends a request to the network to retrieve the MAC address corresponding to the selected IP address.
- **IP Address**, available when **Resolve MAC** check box is selected, allows entering the Next HOP Router IP address: 0.0.0.0 to 255.255.255.255 for IPv4; default is the source IP address; ::1 to FFFF:FFFF:FFFF:FFFF:FFFF:FFFF:FFFF:FFFF for IPv6, default is 2001::.

Local Parameters

- **MEG ID** (Y.1731 and G.8113.1), the Maintenance Entity Group Level identification, allows defining a 13-bytes MEG ID value/message to be generated (default value is **EXFO MEG ID**). Values should be ASCII suitable characters including the *ITU T.50 Characters* on page 40.

Padding allows the selection of the character (**Null** or **Space**) to used for remaining byte values.

- **MAID** (802.1ag and MEF) is a 45 bytes Maintenance Association Identification that is divided into two parameters:
 - **Domain ID** is an optional domain identification text field (0 byte (Domain ID not present), up to 44 bytes minus the **MA Name** field length) set to **EXFO Domain ID** by default.
 - **MA Name** (Short MA Name) is a Maintenance Association Name text field set to **EXFO MA Name** by default. The length of the **MA Name** field is from 1 to either 44 bytes minus the **Domain ID** field length when Domain ID is present or 45 bytes when not present.

- **MEG Level** (Y.1731, MEF, and G.8113.1) is the Maintenance Entity Group Level configurable from **0** to **7** (default).
- **MD Level** (802.1ag) is the Maintenance Domain Level and is configurable from **0** to **7** (default).
- **MEP ID** is the Maintenance Entity Group End Point Identification configurable from **0x0001** (default) to **0x1FFF**.

Peer MEP Parameters

- **MAC Address**, available with S-OAM Mode, allows entering the unique Media Access Control (MAC) address of the peer MEP (default is **00:00:00:00:00:00**).
- **MEP ID** is the Maintenance Entity Group End Point Identification configurable from **0x0001** (default) to **0x1FFF**.
- **OAM Quick Ping** verifies the bidirectional connectivity with the peer MEP. The **Successful** message is reported when at least one of three attempts has been successful otherwise **Failed** is reported.

Continuity Check

- **CC Function** check box when selected (default) allows transmitting and monitoring CCM frames.

The following parameters are only configurable when the **CC Function** check box is cleared.

- **Address Type**, available with S-OAM Mode, defines the destination address type of the CCM frames: **Unicast** or **Multicast** (default).
- **Priority**, available with S-OAM Mode or when VLAN is enabled (see *VLAN* on page 225), allows selecting the VLAN user priority: **0** to **7** (default). Refer to *VLAN ID and Priority* on page 758 for more information.

Test Setup - Test Configurator, Timer, and System

S-OAM and MPLS-TP OAM

- **Drop Eligible**, available with S-OAM Mode or when VLAN is enabled (see *VLAN* on page 225), is set to **No** (no frames will be dropped when congestion occurs) and is not configurable.
- **Period** determines the transmission period of the CCM frame: **3.33 ms**, **10 ms**, **100 ms** (default), **1 s**, **10 s**, **1 min**, or **10 min**.

MPLS-TP Label Stack (G.8113.1)

➤ MPLS-TP Mode

PW (Pseudo-Wire) (default) provides an emulation of a point-to-point connection over a packet-switching network. The PW begins and ends at the LER or PE (Provider Edge).

LSP (Label Switch Path) is a path through a MPLS network, it begins and ends at LER or LSR.

Section is a segment between two adjacent LER/LSR.

- **Label 2** check box when selected enables the MPLS Label 2. The Label 2 check box is configurable for PW and LSP (cleared by default) and is forced cleared for Section.
- **Label 1** check box when selected enables the MPLS Label 1. The **Label 1** check box is forced selected for PW and LSP and forced cleared for Section.
- **GAL** check box when selected enables the Generic Associated Channel Label. The GAL check box is forced selected for LSP and Section and is configurable for PW (selected by default).
- **Label** is configurable for **Label 1** and **Label 2**: **16** to **1048575**, default is **16**. Label is not configurable for GAL and is set to **13**.
- **TC** sets the Traffic Class: **0** (default) to **7**.
- **TTL** sets the Time To Live: **1** to **255**, default is **128**.

Test Function

Note: *Test Function* parameters are not configurable when the **TX Enable** check box is selected.

- **Function** allows the selection of the test function to be performed.
 - **Loopback** (default) function is used to verify the bidirectional connectivity to a peer MEP (**Continuous** check box cleared) and to verify its capability to sustain close to line rate traffic (diagnostic test; **Continuous** check box selected).
 - **Test** function is used to generate a test signal and/or verify the integrity of received test signal from the peer MEP.
 - **Frame Delay** function is used to measure the round trip delay with the peer MEP.
 - **Frame Loss** function is used to measure the frame loss with the peer MEP in both directions from a single end point.
 - **Synthetic Loss** function is used to measure the frame loss with the peer MEP in both directions from a single end point using synthetic frames.
- **TX Enable** check box when selected (cleared by default) allows transmission of frames. However the transmission will only begin when the test is started or if the test is already running. When the **Continuous** check box is cleared, the **TX Enable** check box is automatically cleared once all frames have been transmitted.
- **Address Type**, available with S-OAM Mode, defines the destination address type of the frame: **Unicast** (default) or **Multicast**. Availability of address types depend on selected **S-OAM Mode** and **Test Function**.
- **Continuous** check box when selected (default) specifies that the frame generation is continuous. The **Continuous** check box is cleared for Multicast address type.

Test Setup - Test Configurator, Timer, and System

S-OAM and MPLS-TP OAM

- **Requesting MEP ID TLV** (G.8113.1) check box when selected (default) determines if the Requesting MEP ID TLV is present in the LBM frame. The **Requesting MEP ID TLV** check box is cleared and not selectable when the **Continuous** check box is selected.
- **Priority**, available with S-OAM Mode or when VLAN is enabled (see *VLAN* on page 225), allows selecting the VLAN user priority: **0** (default) to **7**. Refer to *VLAN ID and Priority* on page 758 for more information.
- **Drop Eligible**, available with S-OAM Mode or when VLAN is enabled (see *VLAN* on page 225), when set to **Yes** (DEI = 1), the transmitted frames will be dropped first on receipt when congestion occurs under test. Drop Eligible is only configurable with **Unicast** address type, otherwise is set to **No** (Default). Drop Eligible is set to **No** for **Frame Delay**, **Frame Loss**, and **Synthetic Loss** functions.
- **Period** determines the transmission period of frames which is set to **100 ms**. **Period** is not applicable for Multicast address type or when the **Continuous** check box is selected.
- **TX Rate (%)** is the transmission rate of the LBM frame: **0.0001** to **95 %** for 10M, **99.5 %** for 100M, **99.95 %** for 1G, **99.995 %** for 10G LAN, and **92.8521 %** for 10G WAN. Only available with Loopback test function when the **Continuous** check box is selected.

- **Frame Size** allows entering the frame size. The frame size range for Ethernet II frame format is as follows:
 - S-OAM Mode: 64 to 1518¹. The minimum frame size is adjusted according to the frame structure and parameters selected. For Frame Loss function, the frame size is not configurable and set to the minimum value.
 - MPLS-TP OAM Mode: Minimum and maximum values are as follows. The minimum frame size is adjusted according to the frame structure and parameters selected.

Test Function	MPLS-TP Mode		
	PW	LSP	Section
Loopback	68 ^a to 16000 ¹	72 to 16000 ¹	68 to 16000 ¹
Test	68 to 1522	68 to 1522	64 to 1518
Frame Delay	68 ^{a,b} to 1522	72 ^b to 1522	68 ^b to 1518
Frame Loss ^c	68	68	64

- a. Add 4 bytes when the **GAL** check box is selected.
- b. Add 2 bytes when **Test ID** is selected as **TLV Type**.
- c. The frame size is not configurable and set to the minimum value.

The following table lists each parameter that may affect the minimum and maximum¹ frame size value.

Parameter	Number of bytes to be added	Apply to
802.3 SNAP	8 bytes	Y.1731, MEF, G.8113.1
VLAN	4 bytes per VLAN (up to 3 VLAN)	

1. For the Loopback function the maximum frame size is 16000 bytes for all rates at the exception of 10/100/1000 Mbps electrical interface which is 10000 bytes.

Test Setup - Test Configurator, Timer, and System

S-OAM and MPLS-TP OAM

Parameter	Number of bytes to be added	Apply to
Label 2	4 bytes	G.8113.1
Continuous	18 bytes for Data TLV Type 21 bytes for Test TLV Type	
Requesting MEP ID TLV	56 bytes	

Note: *Sending traffic with frame size >1518 in switched network may result in losing all frames.*

- **Frame Count** is the quantity of frames to be transmitted: **1 to 1000** at the exception of **Frame Loss** function which is **2 to 1000** (default is **10**); set to **1** for Loopback function with Multicast address type; not applicable when the **Continuous** check box is selected at the exception of **Synthetic Loss** function.
- **TLV Type** defines the TLV Type included in the frame: **Data** (Default), **Test (Loopback (Y.1731 and G.8113.1) and Test functions)**, and **Test ID (Frame Delay function)**; is set to **Test** for the **Test** function; set to **Data** for **Synthetic Loss** function; not available for **Frame Loss** function.
- **Payload**, available with **Data** TLV Type, defines the repeating byte pattern used to fill the payload of the **Data** TLV: **0x00 to 0xFF** (default is **0xCC**).
- **Test Pattern**, available with **Test** TLV Type, defines the test pattern used to fill the **Test** TLV: **PRBS31** (default), **NULL**.
- **Test ID**, available with **Test ID** TLV or **Synthetic Loss** function, defines the test ID: **0x00000000 to 0xFFFFFFFF** (default is **0x00000001**).

Restore Carrier Ethernet OAM Defaults

Reverts the Carrier Ethernet OAM test application to its default factory settings.

Services - Global

From the **Test** menu, tap **Setup**, **Test Configurator**, tap on the services block, the **Global** tab, and on the **General** button.

General Button

The following parameters are displayed and configurable per service.

- Check boxes:
 - The first check box (top-left) allows enabling sequentially service(s) within the limit of the link capacity when the **Service Performance Test** is enabled or enabling all services when the **Service Performance Test** is disabled.
 - The check boxes next to the service numbers allow enabling each service individually.

When the **Service Performance Test** is enabled, up to 10 services can be enabled one after the other, as long as the **Total TX Rate** (bandwidth) is not reached (**Committed**). For example, if the first service is using the full bandwidth available, then no other service can be enabled. If the first enabled service uses half bandwidth, then at least another service can be enabled using up to half bandwidth. Thus, to enable a second service, first set the CIR value within the non-used bandwidth (**Available**), then enable it.

When the **Service Performance Test** is disabled, up to 10 services can be enabled one after the other; the total TX rate is not limited.

- **Service Name** indicates the name of each service. Tap on the **Service Name** button to modify the name of each service. See *Services - Profile* on page 280 for more information.
- **Direction**, available with **Dual Test Set** or **Dual Port** topology, indicates respectively results from local to remote (**L->R**) and remote to local (**R->L**), or P1 to P2 (**P1->P2**) and P2 to P1 (**P2->P1**).

Test Setup - Test Configurator, Timer, and System

Services - Global

- **Frame Size** indicates the frame size of each service. Tap on the **Frame Size** button to modify the frame size of each service.
- **Framing** indicates the framing of each service. Tap on the **Framing** button to modify the **Frame Format, Network Layer, Transport Layer, VLAN, S-OAM MEG/MD Level, and MPLS** when applicable (see **Modify Frame Structure** from the *MAC/IP/UDP* on page 204).
- **VLAN (ID/Priority)** indicates the ID and Priority of each VLAN level for each service. Tap on the **VLAN** button to modify the VLAN settings (see **VLAN** from the *MAC/IP/UDP* on page 204).
- **Addressing** indicates the source and destination IP or MAC addresses for each services. Tap on the **Addressing** button to modify the addressing (see **MAC** and **IP** from the *MAC/IP/UDP* on page 204).

Batch button allows bulk configuration for services addressing. Select the check box of each configuration parameter that needs to be copied and set its parameters. From **Apply To**, select all services the copy applies to and tap on the **Copy From** to proceed.

SLA Button

The SLA parameters are displayed and configurable per service. Click on the desired column button to access the configuration settings.

See *General Button* on page 277 for more information on check boxes, **Direction**, and **Service Name**.

See *SLA Parameters* on page 285 for more information on **CIR, CIR+EIR, CBS, EBS, Max Jitter, Max Latency, and Frame Loss Rate**.

Total TX Rate

Note: Only available when the **Service Performance Test** check box is selected (see EtherSAM - Global on page 165). For **Dual Test Set**, the total TX rates are displayed for both **Local** and **Remote** directions.

- **Committed** displays the total enabled TX rate (bandwidth) that will be generated by the selected service(s).
- **Available** displays the total TX rate (bandwidth) available for traffic generation.

Global Options

Rate Unit choices are % (default), **Mbit/s**, and **Gbit/s**.

Copy Service Button

Copy Service button allows copying the services configuration to one or several services.

- **Copy Service** allow selecting the services number from which the configuration will be copied from.
- **To the following Services** allows selecting all services that will inherit the configuration from the selected service. An orange background represents a selected service. A service that is already enabled cannot be selected for copy.
- **Copy** allows confirming the service configuration copy for all selected services.

Services - Profile

The EtherSAM test application supports the configuration of up to 10 different services individually. All parameters are configurable per service.

From the **Test** menu, tap **Setup**, **Test Configurator**, tap on the services block, and on the **Profile** tab.

Service Selection and Activation

Select the service to be configured by either using the left/right arrow or by tapping over the service numbers area then tapping on a specific service number. An orange background indicates the selected service while a green background indicates the services that are enabled.

- **Service** associates a name to the selected service number. Up to 16 characters are allowed. Default service names are **Service 1** to **Service 10**.
- **Enable** check box when selected (cleared by default) enables the selected service. However, the service will be generated only when the test is started. For **Dual Test Set**, services can only be enabled once the connection with the remote unit is established.

When the **Service Performance Test** is enabled, up to 10 services can be enabled one after the other, as long as the **Total TX Rate** (bandwidth) is not reached (**Committed**). For example, if the first service is using the full bandwidth available, then no other service can be enabled. If the first enabled service uses half bandwidth, then at least another service can be enabled using up to half bandwidth. Thus, to enable a second service, first set the CIR value within the non-used bandwidth (**Available**), then enable it.

When the **Service Performance Test** is disabled, up to 10 services can be enabled one after the other; the total TX rate is not limited.

Total TX Rate

Note: Only available when the **Service Performance Test** check box is selected (see EtherSAM - Global on page 165).

Indicates the total transmit rate of all services enabled for transmission. Unit selection is available from the *SLA Parameters* on page 285.

Profile

- **Profile** button allows selecting the emulation profile. The selected service profile icon, name, and configuration (when applicable) is displayed next to the **Profile** button.

Select the emulation profile: **Voice**, **Video**, or **Data** (default).

Voice

- **Voice Codec** choices are **VoIP G.711** (default), **VoIP G.723.1**, and **VoIP G.729**.
- **Number of Calls** allows the selection of the equivalent number of calls that will be generated for the selected stream (default is **1**).
- **CIR** indicates the committed information rate in Mbps based on the number of calls selected.

Video

- **Video Codec** choices are **SDTV (MPEG-2)** - (default), **HDTV (MPEG-2)**, and **HDTV (MPEG-4)**. Only **SDTV (MPEG-2)** is available with the 10 Mbps interface.
- **Number of Channels** is the equivalent number of channels that will be generated for the selected service (default is **1**).
- **CIR** indicates the committed information rate in Mbps based on the number of channels selected.

Test Setup - Test Configurator, Timer, and System

Services - Profile

Note: The **CIR** value will be calculated on the basis of the selected service profile and the value entered in the **Number of Calls** or **Number of Channels** field.

- **Frame Size (Bytes)** indicates the frame size for **Voice** and **Video** profiles and allows changing the frame size for **Data** profile:

Fixed (default)

Profile and Codec	Type	Frame Size (bytes)	
		IPv4	IPv6
Voice Codec: - VoIP G.711 - VoIP G.723.1 - VoIP G.729	Fixed	138 82 78	158 102 98
Video Codec: All	Fixed	1374	1394
Data	Fixed (default)	64 ^a (default) to 16000 ^b	
	Random	64 ^a to 1518 ^c	
	EMIX	64 ^a to 16000 ^b	

- The minimum value is adjusted according to the frame structure and components selected as shown in the following table.
- The maximum frame size is limited to 10000 for 10/100/1000Mbps electrical interface.
- The maximum frame size value is adjusted for each enabled VLAN (+4 bytes per VLAN).

The following table lists each component that may affect the minimum frame size value.

Component	Description
VLAN	4 bytes per VLAN (up to 2 VLAN)
MPLS	4 bytes per label (up to two labels)
UDP	8 bytes
TCP	20 bytes
Ethernet Header	14 bytes
LLC and SNAP Headers	8 bytes
IPv4	20 bytes
IPv6	40 bytes
Using DTS	4 bytes

Note: *Sending traffic with frame size > 1518 in switched network may results in losing these frames.*

- **EMIX** button is available when EMIX type is selected. The EMIX frame sequence is repeated until the test ends.

Quantity allows selecting from 2 to 8 frames size values (default is 5).

EMIX Frame Sizes allows setting the EMIX frame sizes (default are **64, 128, 512, 1024, and 1518**). The minimum frame size value is adjusted according to the frame structure and components selected as shown in the above table.

Restore Default button reverts the quantity and EMIX frame sizes to their default values.

Test Parameters

Note: *Unit selection is available from the SLA Parameters on page 285.*

For **Dual Test Set**, parameters are configurable for both local to remote (**L->R**) and remote to local (**R->L**) directions.

For **Dual Port** topology, parameters are configurable for both P1 to P2 (**P1->P2**) and P2 to P1 (**P2->P1**).

- **Traffic Policing** check box when selected (default) allows stressing the rate limiting of the network by sending traffic at higher rate than committed by the SLA.
- **Burst Max Rate** allows setting the rate that is used for the CBS and EBS burst tests. Only available when the **Burst Test** is enabled (see *EtherSAM - Global* on page 165).

Note: *Changing a criteria value (CIR, CIR+EIR, Ramp Traffic Policing, or Burst Max Rate) may affect the other criteria values in order to comply to the following rules:*

$CIR \leq CIR+EIR \leq Ramp\ Traffic\ Policing\ Rate \leq Line\ Rate$

$CIR \leq CIR+EIR \leq Burst\ Max\ Rate \leq Line\ Rate$

However, make sure that the criteria values comply to the following rule with an adequate margin, as per ITU-T Y.1564 standard, for a burst test to be valid:

$CIR < CIR+EIR < Burst\ Max\ Rate \leq Line\ Rate$

SLA Parameters

The Service-Level Agreement (SLA) parameters allow enabling and defining the pass/fail verdict thresholds for the service.

For **Dual Test Set**, parameters are configurable for both local to remote (**L->R**) and remote to local (**R->L**) directions at the exception of Max Round-Trip Latency for which the value is unique.

For **Dual Port** topology, parameters are configurable for both P1 to P2 (**P1->P2**) and P2 to P1 (**P2->P1**).

Information Rate

- Unit choices are % (default), **Mbit/s**, or **Gbit/s**. This unit is also used for **Total TX Rate** and for **Test Parameters (Traffic Policing and Burst Max Rate)**.

Note: *At least one check box (**CIR** or **CIR+EIR**) has to be selected. Thus, clearing the **CIR** check box while **CIR+EIR** check box is cleared, will automatically select the **CIR+EIR** check box and vice versa.*

- **CIR** (Committed Information Rate) check box when selected (default) sets the service rate guaranteed by the SLA. The threshold value is configurable from **0.0001**¹ to **100** percent (default is **50** percent). CIR and preceding steps are not performed for services that have the CIR check box cleared.
- **CIR+EIR** check box when selected (cleared by default) sets the best effort allowed traffic for the service. The EIR (Excess Information Rate) value is equal to the CIR+EIR value minus CIR. The threshold value is configurable from **0.0001**¹ to **100** percent (default is **75** percent).

Burst Size settings are only available when the **Burst Test** is enabled (see *EtherSAM - Global* on page 165).

- Burst Size unit choices are **Bytes** (default) or **ms**.

1. The minimum rate is 1Mbit/s when the **Frame Size** is **Random**.

Test Setup - Test Configurator, Timer, and System

Services - Profile

- **CBS** check box when selected (default) sets the maximum committed burst size to which services' frames will be sent and be CIR-compliant (default is **12144** bytes). The CBS minimum and maximum values are affected by the **CIR**, **Burst Max Rate**, and **Frame Size** values. CBS is only available when CIR check box is selected.
- **EBS** check box when selected (cleared by default) sets the maximum excess burst size to which services' frames will be sent and be CIR+EIR compliant (default is **12144** bytes). The EBS minimum and maximum values are affected by the **CIR+EIR**, **Burst Max Rate**, and **Frame Size values**. EBS is only available when **CIR+EIR** check box is selected.

Performance Criteria

- **Max Jitter (ms)** allows setting the maximum jitter value in millisecond, allowed for the service: **0.015 to 8000 ms** (default is **2 ms**).
- **Max Round-Trip Latency (ms)** allows setting the maximum round-trip latency value in millisecond allowed for the service: **0.015 to 8000 ms** (default is **15 ms**). For **Dual Test Set**, only available with **Round-Trip Latency Measurement Mode** (see *Global Options* on page 168). Not available in **Dual Port** topology.
- **Max Latency**, available for **Dual Test Set** with **One-Way Latency Measurement Mode** (see *Global Options* on page 168) and Dual Port topology, allows setting the maximum one-way latency allowed for the service: **0.015 to 500 ms** (default is **15 ms**).
- **Frame Loss Rate** allows setting the maximum rate of Frame Loss allowed for the service: **0.0E00 to 5.0E-02**, default is **1.0E-03**.

Note: For Dual Test Set, the Frame Loss Rate is changed to percentage when the remote module does not support exponential notation. In this case a Frame Loss Rate Threshold lower than 1.0E-06 (0.0001 %) is considered as 0 %; the configurable range is 0 to 5 %.

Signal (Transport)

From the **Test** menu, tap **Setup, Test Configurator**, the interface block, and the **Signal** tab.

Physical Interface - Optical

Note: For electrical interface, see Physical Interface - Electrical on page 289.

- **Optical Lane** indicates the optical lane number for parallel interfaces.

Optical Interface	Optical Lane Number
OTU3 (4 Lanes) [43.018 Gbit/s]	0 through 3
OTU3e1 (4 Lanes) [44.571 Gbit/s]	
OTU3e2 (4 Lanes) [44.583 Gbit/s]	
OTU4 (4 Lanes) [111.81 Gbit/s]	

- **Laser¹** indicates the status of the laser: **ON** with the laser pictogram (emitting an optical laser signal) or **OFF**.
- **TX Power (dBm)¹** indicates, when supported, the transmit power level of the optical lane/laser in dBm.
- **Wavelength (nm)¹** indicates, when supported, the detected lane/laser wavelength.
- **RX Power (dBm)¹** indicates, when supported, the current received power level of the optical lane/laser in dBm.

Green: Power level in range.

Yellow: Power level out-of-range.

Red: Loss of signal or power level is close to damage.

Gray: Invalid operational range value or not available/supplied by the transceiver.

1. Displayed for each optical lane for parallel interfaces.

Test Setup - Test Configurator, Timer, and System

Signal (Transport)

- **Min RX Power (dBm)**¹ indicates, when supported, the minimum received power level of the optical lane/laser in dBm.
- **Max RX Power (dBm)**¹ indicates, when supported, the maximum received power level of the optical lane/laser in dBm.
- **Laser ON/OFF** button is used for parallel interfaces to activate the laser control per optical lane or for all lanes.

Optical lane numbers are from **0** to **3** or **0** to **7** depending on the selected interface/rate.

- **All Lanes** check box, when selected, applies the change(s) to all optical lanes at once.
- **Optical Lane** indicates the optical lane numbers and **All** which represents the setting for all optical lanes when the **All Lanes** check box is selected.
- **Laser** check box, when selected, indicates that the corresponding optical laser lane is activated and emitting an optical laser signal.
- **Lasers OFF at Start-Up** check box when selected automatically turns OFF the laser for serial interfaces or all lasers for parallel interfaces when starting the Power Blazer or when switching from one test application to another. However the laser remains ON, on a remote module receiving a request for a DTS connection or a loopback command. This check box is cleared by default.
- **Power Range (dBm)** indicates the transceiver operational RX power range.

1. Displayed for each optical lane for parallel interfaces.

Physical Interface - Electrical

Note: *The following settings are available with electrical signal and their availability depend on the signal itself and its mapping. For optical interface, see Physical Interface - Optical on page 287.*

- **LBO (Line Build Out):** The **LBO** allows meeting the interface requirements over the full range of cable lengths.

Signal	LBO
DS1	Preamplification values: DSX-1 (0-133 ft)^a , DSX-1 (133-266 ft) , DSX-1 (266-399 ft) , DSX-1 (399-533 ft) , DSX-1 (533-655 ft) , Cable simulation (CSU Emulation mode) values: CSU (0.0 dB) , CSU (-7.5 dB) , CSU (-15.0 dB) , CSU (-22.5 dB) .
DS3	0 to 225 ft range^a , 225 to 450 ft range , and Cable Simulation 900 ft .
E1/E3/E4	Not available
STS-1e/STM-0e	0 to 225 ft range^a , 225 to 450 ft range , and Cable Simulation 900 ft .
STS-3e/STM-1e	0 to 225 ft range .

- a. Default value

Test Setup - Test Configurator, Timer, and System

Signal (Transport)

➤ Line Coding

Signal	Line Coding
DS1	AMI and B8ZS ^a
DS3	B3ZS
E1	AMI and HDB3 ^a
E3	HDB3
E4	CMI
STS-1e/STM-0e	B3ZS
STS-3e/STM-1e	CMI

a. Default value.

➤ RX Termination

Signal	Termination
DS1/E1	Term ^a , Mon, and Bridge.
DS3/E3/E4/STS-1e/STM-0e/STS-3e/STM-1e	Term ^a , and Mon

a. Default value.

- **Power** indicates the received signal level in dBdsx for DS_n or dBm for PDH and SONET/SDH.
- **Amplitude** indicates the received signal amplitude as well as its MIN, and MAX received values.

TX Frequency

Note: The following TX Frequency information applies to serial interface only, refer to TX Frequency on page 175 for parallel interfaces.

- **TX Frequency (GHz)** indicates the frequency (actual frequency + Frequency offset) used for transmission.
- **Offset (ppm)** check box, when selected (cleared by default), allows setting the frequency offset that will be generated. Use the “+” or “-” button to respectively increment or decrement the frequency offset value based on the defined **Increment/Decrement Size**, or directly type the frequency offset value in the field. Possible offsets are:

Interface	Frequency Offset ^a	Nominal Frequency
DS1	± 140 ppm	1544000 bit/s
E1	± 70 ppm	2048000 bit/s
E3	± 50 ppm	34368000 bit/s
DS3		44736000 bit/s
STS-1e/STM-0e		51840000 bit/s
E4		139264000 bit/s
STS-3e/STM-1e		155520000 bit/s
OC-1/STM-0		± 50 ppm
OC-3/STM-1	155520000 bit/s	
OC-12/STM-4	622080000 bit/s	
OC-48/STM-16	2488320000 bit/s	
OC-192/STM-64	9953280000 bit/s	
OTU1	± 50 ppm	
OTU2	± 50 ppm (Framed) ± 120 ppm (Unframed)	10709225316 bit/s

Test Setup - Test Configurator, Timer, and System

Signal (Transport)

Interface	Frequency Offset ^a	Nominal Frequency
OTU1e	± 120 ppm	11049107143 bit/s
OTU2e		11095727848 bit/s
OTU1f		11270089286 bit/s
OTU2f		11317642405 bit/s

- a. The frequency offset range is guaranteed for a source signal at 0 ppm. In the event that the source signal already has an offset, then the output signal may exhibit an offset larger than the range specified.

Note: *Frequency offset is not available when **Through** mode is selected.*

Step Size (ppm) allows setting the increment/decrement value (from 0.1 to the maximum offset) that will be used when changing the frequency offset with the “+” or “-” button.

RX Frequency

Note: *The following RX Frequency information applies to serial interface only, refer to RX Frequency on page 176 for parallel interfaces.*

- **Frequency (GHz)** indicates the frequency of the input signal.
- **Offset (ppm)** indicates the frequency offset between the standard rate specification and the rate at the input signal.

Note: For both **Frequency** and **Offset** the following background colors are used:

Background color	Description
Green	The frequency is in range.
Red	The frequency is out-of-range or LOC Lane. LOC is also displayed.
Gray	Pending state.

- **Max. Negative Offset (ppm)** indicates the maximum negative frequency offset between the standard rate specification and the rate from the received signal.
- **Max. Positive Offset (ppm)** indicates the maximum positive frequency offset between the standard rate specification and the rate from the received signal.

Note: Refer to Interface on page 374 for more information on standard rate specifications.

Signal Configuration

- For OTN, refer to *Signal - Signal Configuration (OTN)* on page 302 for more information.
- For SONET/SDH, refer to *Signal - Signal Configuration (SONET/SDH)* on page 307 for more information.
- For DS_n/PDH, refer to *Signal - Signal Configuration (DS_n/PDH)* on page 294 for more information.

Signal - Signal Configuration (DSn/PDH)

For SONET/SDH - DSn/PDH BERT, from the test menu, tap **Setup**, **Test Configurator**, and the protocol block. Only **Framing** setting and the **Loopback** button are available.

For DSn/PDH BERT and NI/CSU Emulation, from the test menu, tap **Setup**, **Test Configurator**, and the interface block.

Framing

Framing allows the selection of the framing used for transmission:

DS1	DS3	E1	E3/E4
Unframed SF ESF ^a SLC-96	Unframed C-Bit Parity ^a M13	Unframed PCM30 ^a PCM30 CRC-4 PCM31 PCM31 CRC-4	Unframed Framed ^a

a. Default value

Background

For multiplex test case, allows the selection of the default timeslot background traffic: **AIS** (default) or **All Zeros**.

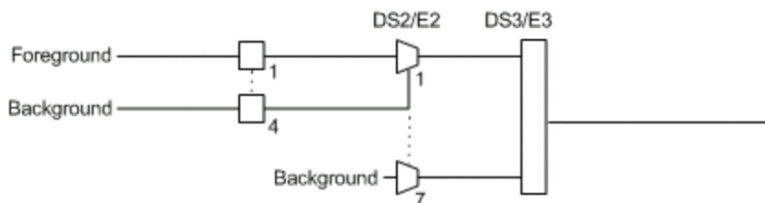

The diagram above shows a test case defined with DSn/PDH traffic where the background traffic is also inserted for the unused timeslots in a test case data path. The insertion is similar to the low order path SONET/SDH terminated signal where the background traffic format inserted uses the same rate as the one defined in the test case data path.

Channel

Channel, for multiplex text case, allows the selection of the channel number of the mapped signal.

DS0/E0

The **DS0/E0** check box when selected, cleared by default, activates the DS0/E0 testing. DS0/E0 configuration is not available when the framing is set to **Unframed**. Once selected, a summary of the payload content is displayed indicating the number of timeslot set to Pattern and Idle/Tone. The Modify DS0/E0 button is also displayed.

TX Signaling

The **TX Signaling** check box when selected (cleared by default) allows generation of the signaling bits for either the 24 - DS0 channels or 30 - E0 channels (PCM-30 and PCM30 CRC-4). Only available when the **DS0/E0** check box is selected.

Modify DS0/E0

Modify DS0/E0 button is only available when the **DS0/E0** check box is selected.

Note: For DS0, the framing structure has 24 timeslots. For E0, the framing structures PCM-30 and PCM30 CRC-4 have 30 channel timeslots (1 to 15 and 17 to 31) while PCM-31 and PCM-31 CRC-4 have 31 channel timeslots (1 to 31).

- **DS0/E0 Size** sets the channel timeslot data rate for the pattern payload content to either **56K** or **64K** (default); forced to respectively **56K** for DS0 and **64K** for E0 when **TX Signaling** is enabled. A timeslot data rate of 56 Kbit/s uses 7 bits while 64 Kbit/s uses 8 bits to carry the payload information.
- **Zero Code Suppression** allows the selection of the Zero Code Suppression (ZCS) method used to replace the all-zero bytes of the Idle and Tone payload contents. The ZCS mechanism is a global parameter meaning that all channel timeslots configured with Tone/Idle data, use the same ZCS method. Choices are:

ZCS	Description	Available with
None ^a	No Zero Code Suppression	DS0 and E0
Jammed Bit 8	Every 8th (LSB) bit is forced to 1.	DS0 and E0
GTE	Bit 8 of an all zero channel byte is replaced by 1, except in signaling frames where bit 7 is forced to 1.	DS0
Bell	Bit 7 of an all zero channel byte is replaced by 1.	DS0

a. Default value.

Note: Bit 8 is the Least-Significant Bit (LSB) and bit 1 is the Most-Significant Bit (MSB).

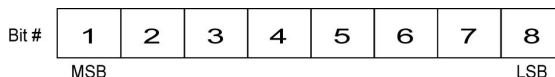

➤ **Payload Content and Set All**

Payload Content allows the selection of the payload content that will be applied to all TX timeslots when tapping the **Set All** button: **Pattern**, **Idle**, or **Tone**.

➤ **TX**

Tap once or several times on each timeslot until the desired payload content appears: **Pattern** (default), **Idle**, or **Tone**. For E0, timeslots 0 and 16 (PCM30 and PCM30 CRC4) are not configurable; timeslot 0 generates the FAS/NFAS framing; timeslot 16 generates a static MFAS frame when TX Signaling is disabled and generates a frame with Signaling capability when TX Signaling is enabled.

Note: For **Pattern**, the pattern used is the one selected from **Pattern** on page 139.

Tone (Hz) allows the selection of a tone for digital milliwatt testing. The signal output power, when converted to analog, is 0 dBm. Choices are **1000 Hz** and **1004 Hz** (default). The selected Tone applies to all timeslots set to Tone.

Idle uses the Idle code byte from the Idle field. Choices are **00** to **FF**. The selected Idle code applies to all timeslots set to Idle. The default setting is **7F**.

Note: The timeslots set to **Idle** or **Tone** can be changed from **Idle** to **Tone** and vice versa even when the test is running; the **Idle** and **Tone** values can also be changed.

Binary allows either displaying the Idle code values in binary (when selected) or in hexadecimal (default).

Test Setup - Test Configurator, Timer, and System

Signal - Signal Configuration (DSn/PDH)

► RX

Apply Channel TX to RX, available for decoupled test, allows applying the RX payload content based on the TX settings. **None** will be used when TX is set to either **Idle** or **Tone**. For E0 the timeslots 0 and 16 (PCM30 and PCM30 CRC4) are not configurable. Timeslot 0 processes the FAS/NFAS while timeslot 16 processes the Signaling frame.

Note: *The RX timeslot selection is only configurable in a **Decoupled** topology when the **Apply Channel TX to RX** check box is cleared. A warning is displayed when the number of Pattern timeslot does not match between TX and RX. This is to ensure pattern continuity between the TX and RX interface in a MUX/DEMUX test even if used through a cross-connect device.*

Select the payload content by tapping once or several times on each timeslot until the desired content appears.

Pattern (default) uses the pattern from the received signal.

None does not use the pattern.

Loopback button

The Loopback feature generates a code that is interpreted by the DUT. The DUT interprets the command and implements the loopback.

Select the type of loopback that will be used to overwrite the traffic that will be generated. Choices are listed in the following table in addition with 10 predefined Loop Codes (see *Modify Loop Codes button* on page 299).

Loopback Type	Command	
	Loop-Up	Loop-Down
CSU (10000/100)	10000 (default)	100
NIU FAC1 (1100/1110)	1100	1110

Loopback Type	Command	
	Loop-Up	Loop-Down
NIU FAC2 (11000/11100)	11000	11100
NIU FAC3 (100000/100)	100000	100

- **Loop-Up** injects the selected loop up code. The loop code will be generated continuously for a maximum of 10 seconds or until the loopback is confirmed. After 10 seconds, if the loopback has failed, a Loop-Down command is sent. A pop-up window appears indicating the loop code injection progress and result. The text box next to the Loop-Up button indicates the selected loop up code.
- **Loop-Down** injects the selected loop down code. The loop code will be generated continuously for a maximum of 10 seconds or until the loopback is confirmed. After 10 seconds, if the loopback has failed, a Loop-Down command is sent. A pop-up window appears indicating the loop code injection progress and result. The text box next to the Loop-Down button indicates the selected loop down code.
- **Modify Loop Codes** button

Allows the configuration of 10 DS1 loop code pairs. Configure each loop code name, Loop-Up and Loop-Down values.

The name field allows up to 16 characters long. Loop-Up and Loop-Down range is from 3 to 16 bits (**000** to **1111111111111111**). The default DS1 loop codes correspond to the DS1 In-Band loop codes (Loop-Up=**10000**, and Loop-Down=**100**).

DS1 Loopback - for NI/CSU Emulation Test

The Loopback feature generates a code that is interpreted by the DUT. The DUT interprets the command and implements the loopback.

- **Mode** selects the loopback control Mode; **Manual** or **Auto-Response**.
- **Type**
 - For **Manual**: Select the Type of loopback code that will be applied; **Line**, or **Payload**. Payload is not available when the framing is **Unframed**.
 - For **Auto-Response**: Select the Type of loopback code on which the module will respond; **In-Band** or **Out-of-Band**. **Out-of-Band** is only available when the interface framing is set to ESF. The Loop-UP and Loop-Down values are automatically updated to the In-Band or Out-of-Band selection (Type).
- **Status** indicates either **Loopback Active** with a green loopback icon or **No Loopback** with a gray loopback icon.
- **Loop Code** selects the type of loopback that will be used to overwrite the traffic that will be generated.

In-Band loop code	Loop-UP Code	Loop-Down Code
CSU (10000/100)	10000	100
NIU FAC1 (1100/1110)	1100	1110
NIU FAC2 (11000/11100)	11000	11100
NIU FAC3 (100000/100)	100000	100
Loop Code 1 to 10	Refer to <i>Modify Loop Codes</i> button on page 299.	

Test Setup - Test Configurator, Timer, and System

Signal - Signal Configuration (DSn/PDH)

Out-of-Band loop code	Loop-UP Code	Loop-Down Code
Line	00001110 11111111	00111000 11111111
Payload	00010100 11111111	00110010 11111111
Reserved For Network Use	00010010 11111111	00100100 11111111
ISDN Line (NT2)	00101110 11111111	00100100 11111111
CI/CSU Line(NT1)	00100000 11111111	00100100 11111111

- **Force Release / Activate / Release**
 - **Force Release** button, available with **Auto-Response** mode, allows releasing a loopback condition initiated from the network. Only available when a loopback is active.
 - **Activate** button, available with **Manual** mode when no loopback is active, allows sending a loopback condition.
 - **Release** button, available with **Manual** mode when a loopback is active, allows releasing the loopback condition.
- **Loop-Up** indicates the selected loop up code.
- **Loop-Down** indicates the selected loop down code.
- **Modify Loop Codes** button: See *Modify Loop Codes* button on page 299 for more information.

Signal - Signal Configuration (OTN)

Note: *The following signal configuration parameters are available from the interface block.*

From the **Test** menu, tap **Setup, Test Configurator**, the interface block, and on the **Signal** tab.

- **OTU4, OTU3, OTU3e1, OTU3e2, OTU2, OTU2f, OTU1f, OTU2e, OTU1e, or OTU1**

Note: *At least one of the two check boxes, **FEC** or **Scrambler**, must be selected in order to prevent potential alarms caused by a lack of bit transition on the optical signal. For example to disable **FEC**, first select the **Scrambler** check box then clear the **FEC** check box.*

- **FEC** check box, when selected (default), enables the FEC in TX/RX and allows detecting, reporting, and correcting up to 8 symbol errors (Correctable) per codeword. If there are over 8 symbol errors detected, they are reported as uncorrectable errors.
- **Scrambler** check box, when selected (default), provides enough “0” and “1” transitions on the optical signal for clock recovery.

Note: *When the **Scrambler** check box is cleared, the receiver circuitry is forced to operate in a condition which is outside of the specified OTN operating conditions, potentially causing alarms/errors. This configuration can be used for special analysis in a lab environment.*

- **ODU4, ODU3, ODU3e1, ODU3e2, ODU2, ODU2f, ODU1f, ODU2e, ODU1e, ODU1, ODU0, or ODUflex.** Only the higher ODU layer is available with Multi-Channel OTN.
 - **OPU Tributary Port**¹, available for each OPU level of a mapped signal, indicates the OPU tributary port used for the test. Tap the **Modify Trib Slots/Port** button to change the OPU tributary port.
 - **OPU Tributary Slots**¹, available for each OPU level of a mapped signal, indicates the OPU tributary slots used for the test. Tap the **Modify Trib Slots/Port** button to change the OPU tributary slots.
 - **TCM** indicates each Tandem Connection enabled; **No TCM** indicates that no TCM is enabled. To enable TCM, tap the **Config TCM**¹ button.

1. Not available with Multi-Channel OTN.

Test Setup - Test Configurator, Timer, and System

Signal - Signal Configuration (OTN)

- **Background Traffic**, available for a multiplex signal, is used to generate traffic on the timeslots that are not part of the foreground test traffic. Choices are **Unallocated** (available with PT21 only), **AIS**, **Null Client**, and **PRBS31** (default). The background traffic is configurable for each mux type when the multiplex signal contains both PT20 and PT21 mux types.

Higher Layer	Tributary	Background Traffic ^a
ODU4	ODU3, ODU2, ODU1, ODU0, ODU2e, ODU1e, ODUflex	1.25 Gbit/s ^b or Unallocated
ODU3	ODU2	Fixed structure: ODU2 Non fixed structure: ODU1
	ODU1	ODU1
	ODU0, ODUflex	1.25 Gbit/s ^b or Unallocated
ODU2	ODU1	ODU1
	ODU0, ODUflex	1.25 Gbit/s ^b or Unallocated
ODU1	ODU0	ODU0

- Uses the selected AIS, Null Client, or PRBS31 background traffic unless Unallocated is selected which corresponds to undefined traffic.
- Per tributary slot.

➤ **Modify Tributary Slots/Port¹**

The payload type 20 or 21 is indicated for each mapped OPU level.

For...	Mapped into...	Tributary slot selection
ODU3	OPU4	31
ODU2e ODU1e	OPU4	8
ODU2	OPU4 OPU3	8 4 (PT20), 8 (PT21)
ODU1	OPU4 OPU3 OPU2	2 1 (PT20), 2 (PT21) 1 (PT20), 2 (PT21)
ODU0	OPU4 OPU3 OPU2 OPU1	1 1 1 1
ODUflex	OPU4 OPU3 OPU2	up to 80 up to 32 up to 8
ODUflex/GFP-F	OPU4 OPU3 OPU2	up to 8 up to 8 up to 8

- **Fixed Structure** check box when selected (default) for OPU3, the selection of a tributary slot will automatically select four tributary slots from the same column, which constitute the foreground traffic. When the **Fixed Structure** check box is cleared, select the four tributary slots individually.

1. Not available with Multi-Channel OTN.

Test Setup - Test Configurator, Timer, and System

Signal - Signal Configuration (OTN)

- **Tributary Port**, configurable when the **Fixed Structure** check box is cleared, allows selecting the **Tributary Port** number that will be associated to the selected tributary slots. When the **Fixed Structure** check box is selected, the **Tributary Port** is automatically assigned to either the selected slot number or for OPU3 to the first slot number in the column.
- **Nominal Bit Rate (Gbit/s)** available with ODUflex and ODUflex/GFP-F indicates the TX frequency based on the number of tributary slots selected. Note that for ODUflex with pattern Client, the **Nominal Bit Rate** may be affected by the **TX Rate** when not set to 100 % (see **TX Rate** on page 139).
- **Number of Trib Slots** indicates the number of tributary slots selected.

Note: *Tributary slots must be selected starting with the higher layer down to the lower and all required tributary slots must be selected to access the next level. **Clear All**, **Select All**, and **Default** buttons may be used to facilitate the selection.*

➤ **Config TCM**

Allows enabling each TCM level (1 to 6) individually. All ODUx of a mapped signal are also available. All TCM check boxes are cleared by default (disabled). Refer to *Traces (OTN)* on page 332 for more information. Not available with Multi-Channel OTN.

Signal - Signal Configuration (SONET/SDH)

For OTN-SONET/SDH BERT, from the **Test** menu, tap **Setup, Test Configurator**, the protocol block, and the **Signal** tab.

For SONET/SDH BERT, from the **Test** menu, tap **Setup, Test Configurator**, the interface block, and the **Signal** tab.

OC/STM Signal

- **Synchronization Status Message (S1)**: Bits 5 through 8 of the S1 byte are used to convey synchronization status of the NE. Not available with **Through** topology.

Bits 5 to 8	Description	
	SONET	SDH
0000 ^a	Synchronized - Traceability Unknown (STU)	Quality Unknown
0001	Stratum 1 Traceable (ST1)	Reserved
0010	Reserved	ITU G.811 (PRC)
0011	Reserved	Reserved
0100	Transit Node Clock Traceable (TNC)	SSU-A
0101	Reserved	Reserved
0110	Reserved	Reserved
0111	Stratum 2 Traceable (ST2)	Reserved
1000	Reserved	SSU-B
1001	Reserved	Reserved
1010	Stratum 3 Traceable (ST3)	Reserved
1011	Reserved	ITU-T G.813 Option I (SEC)
1100	SONET Minimum Clock Traceable (SMC)	Reserved
1101	Stratum 3E Traceable (ST3E)	Reserved
1110	Provisionable by the Network Operator (PNO)	Reserved
1111	Don't Use for Synchronization (DUS)	Do not use for synchronization

- a. Default message.

Test Setup - Test Configurator, Timer, and System

Signal - Signal Configuration (SONET/SDH)

- **REI-L/MS-REI Computation Method** (OC-192/STM-64 only): Allows selecting the default method used to calculate the REI-L/MS-REI error for OC-192 and STM-64 signals. Choices are **M1 Only** and both **M0 and M1**. The default setting is M1 only.

STS/AU and VT/TU Mappings

- **Timeslot/Number**

Timeslot (SONET) allows the selection of the STS timeslot number. Refer to *SONET Numbering Convention* on page 749 for more information.

Number (SDH) allows the selection of the AU channel number. Refer to *SDH Numbering Convention* on page 750 for more information.

- **TCM** check box when selected (cleared by default) allows Tandem Connection Monitoring (TCM).
- **TC-UNEQ-P / TC-UNEQ-V / HPTC-UNEQ / LPTC-UNEQ** check boxes when selected (cleared by default) allows the monitoring of the corresponding Tandem Connection - Unequipped alarm. Only available when the **TCM** check box is selected.
- **Overwrite Fixed Stuff** (STS-1 only) check box when selected (default) fills up the bytes of the STS-1 SPE's columns 30 and 59 with the selected pattern from the tab *BERT and Unframed BERT* on page 139.
- **Background** allows the selection of the high order path background traffic: **AIS, Equipped** (PRBS23) - (default), or **Unequipped**.

Test Setup - Test Configurator, Timer, and System

Signal - Signal Configuration (SONET/SDH)

STS/AU Path (SONET/SDH HOP):

The following diagram shows a test case data path that is terminated right after SONET/SDH high order path. High order background traffic is automatically adapted to the rate (STS-1, AU-3, or AU-4) signal level for the paths that are not defined in the test case. In the situation where the traffic pattern is replaced by GFP the background traffic remains the same for the STS-1/AU-3/AU-4 that are not involved in the test case data path. In the situation where contiguous concatenation or virtual concatenation is used, the background traffic continues to be applied on the remaining timeslots not involved in the test case data path.

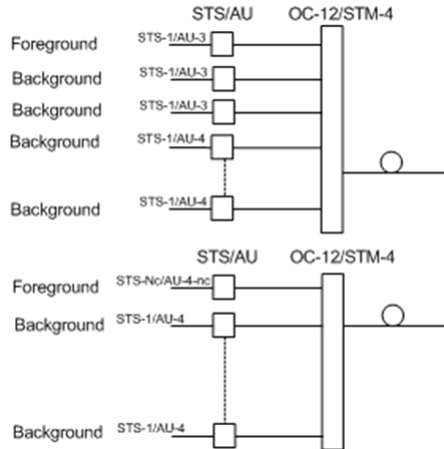

Test Setup - Test Configurator, Timer, and System

Signal - Signal Configuration (SONET/SDH)

VT/TU Path (SONET/SDH LOP)

The following diagram shows a test case data path that is terminated at the SONET/SDH low order path. The remaining STS-1 or AU-3 timeslot not involved in the test case are filled with background traffic of STS-1 or AU-3 level depending on the interface being SONET or SDH. At the low order path level, the data path not involved in the data path defined in the test case are filled with a background traffic equivalent to the VT Group (VTG) or Tributary Unit Group (TUG) type defined by the traffic selected in the data path. Further, the remaining VTG or TUG within the high order path, selected in the test case, are respectively filled with traffic of equivalent rate for SONET and SDH data paths.

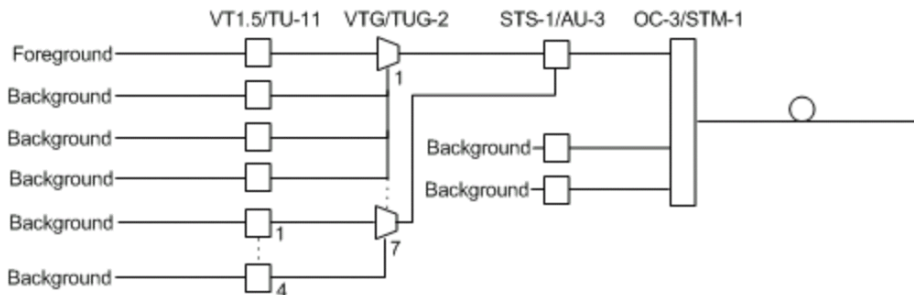

Smart Loopback

Note: The Smart Loopback block is only displayed when the **Transparent (Pseudo-Physical)** check box is cleared (see Loopback Mode on page 125).

From the **Test** menu, tap **Setup, Test Configurator**, and the Smart Loopback block.

Loopback

- **Mode** determines at which layer the Smart Loopback address/port swapping operation will be.
 - **Ethernet** swaps the MAC addresses of received packets having their **Destination MAC** address matching the MAC address of the loopback port.
 - **Ethernet (All Unicast)** swaps the MAC addresses of received packets having Unicast **Destination MAC** address.
 - **IP**, for Ethernet Layer 3 and 4, swaps the MAC and IP addresses of received packets having their **Destination IP** address matching the IP address of the loopback port. For Ethernet Layer 2, swaps the **MAC addresses** for packets having their **Destination MAC** address matching the MAC address of the loopback port.
 - **UDP/TCP** (default), for Ethernet Layer 4, swaps the UDP or TCP ports and the MAC and IP addresses of received packets having their **Destination IP** address matching the IP address of the loopback port. For Ethernet Layer 3, swaps the MAC and IP addresses for packets having their **Destination IP** address matching the IP address of the loopback port. For Ethernet Layer 2, swaps the **MAC addresses** for packets having their **Destination MAC** address matching the MAC address of the loopback port.
- **Matching & Swapping** indicates the Loopback parameters that will be used based on the Loopback Mode selected.

S-OAM Responder

The S-OAM Responder check box when selected (default) allows responding to LBM, LTM, DMM, LMM, and SLM valid messages (test running or not). Traffic statistics are also monitored (refer to *Responder* on page 535).

Respond to... message	Respond with... message
LBM	LBR
LTM	LTR
DMM	DMR
LMM	LMR
SLM	SLR

Streams - Global

From the **Test** menu, tap **Setup, Test Configurator**, the protocol block, and the **Global** tab.

The following parameters are displayed and configurable per stream.

➤ Check boxes:

The first check box (top-left) allows enabling stream(s) sequentially within the limit of the link capacity.

The check boxes next to the stream numbers allow enabling each stream individually within the limit of the link capacity.

- **Stream Name**¹ indicates the name of each stream. Tap on the **Stream Name** button to modify the name of each stream.
- **Frame Size**¹ indicates the frame size of each stream. Tap on the **Frame Size** button to modify the frame size of each stream.
- **TX Rate**¹ indicates the transmission rate for each stream. Tap on the **TX Rate** button to modify the transmission rate (see page 319).
- **Framing** indicates the framing of each service. Tap on the **Framing** button to modify the **Frame Format, Network Layer, Transport Layer, VLAN, and MPLS** when applicable (see **Modify Frame Structure** from the *MAC/IP/UDP* on page 204).
- **VLAN** indicates the ID and Priority of each VLAN level for each stream. Tap on the **VLAN** button to modify the VLAN settings (see **VLAN** from the *MAC/IP/UDP* tab).

1. See the Profile tab for more information.

Test Setup - Test Configurator, Timer, and System

Streams - Global

- **Addressing MAC/IP** indicates the source and destination MAC/IP addresses for each stream. Tap on the **Addressing MAC/IP** button to modify the customer addressing (see **MAC** and **IP** from the **MAC/IP/UDP** tab). When using **Provider Encapsulation**, the source and destination addresses displayed are respectively EoE MAC for EoE and B-MAC for PBB-TE.

Batch button allows bulk configuration for stream addressing. Select the check box of each configuration parameter that needs to be copied and set its parameters. From **Apply To**, select all streams the copy applies to and tap on the **Copy From** to proceed.

The following parameters are global for all streams.

- **Total TX Rate** indicates the percentage of the total line utilization which is the TX rate sum of all enabled streams.
- **Link Capacity** indicates the total rate available for traffic generation.
- **Global Options:**
 - **Rate Unit** choices are % (default), **Mbit/s**, **Gbit/s**, **frame/s**, and **IFG**.
 - **QoS Metrics Tags Insertion** check box when selected (default) automatically adds a stream analysis tag containing Jitter, Latency, Throughput, and sequence tags in all frames that is generated.
- **Copy Stream** button allows copying the stream configuration to one or several streams.

Select the stream number the configuration will be copied from.

From **To the following Streams**, select all streams that will inherit the configuration from the selected stream. An orange background represents a selected stream. A stream that is already enabled (Enable TX) cannot be selected for copy.

Tap **Copy** to confirm the stream configuration for all selected streams.

- **Restore Default** button reverts the current test application to its default factory settings.

Streams - Profile

The Traffic Gen & Mon test application supports the configuration of up to 16 different streams individually.

From the **Test** menu, tap **Setup**, **Test Configurator**, the protocol block, and the **Profile** tab.

Note: *All parameters are configurable per stream.*

Stream Selection and Activation

Select the stream to be configured by either using the left/right arrow or by tapping over the stream numbers area then tapping on a specific stream number. An orange background indicates the selected stream while a green background indicates the streams that are enabled.

- **Stream** associates a name to the selected stream number. Default stream names are **Stream 1** to **Stream n**.
- **Enable** check box when selected (cleared by default) enables the selected stream. However, the stream will be generated only when the test is started while the global **Enable TX** check box is selected from the **Global** tab.

Profile

- **Profile** button allows the selection and configuration of either **Voice**, **Video**, or **Data** (default) emulation profile. The selected profile icon and its Codec for Voice and Video are displayed next to the **Profile** button. Only **Data** is available when using **Provider Encapsulation**.

Voice when selected allows the configuration of the following parameters.

- **Voice Codec** allows the selection of the codec used by the voice profile: **VoIP G.711** (default), **VoIP G.723.1**, or **VoIP G.729**.
- **Number of Calls** allows the selection of the number of calls that will be generated for the selected stream. The minimum and default value is **1** for 10M to 1G interface, **5** for 10G, and **10** for 40G and 100G interfaces.
- **Rate** indicates the rate corresponding to the selected codec and the number of calls.

Video when selected allows the configuration of the following parameters.

- **Video Codec** allows the selection of the codec used by the video profile: **SDTV (MPEG-2)** - (default), **HDTV (MPEG-2)**, or **HDTV (MPEG-4)**.
- **Number of Channels** allows the selection of the number of channels (**1** by default) that will be generated for the selected stream.
- **Rate** indicates the rate corresponding to the selected coded and the number of channels.

- **Frame Size (Bytes)** for Data profile is selectable: **Fixed** (default), **Random**, or **Sweep**. The Frame Size is forced to **Fixed** for Voice and Video profiles. Only **Fixed** frame size is available when using **Provider Encapsulation**.
- For **Fixed** type, the frame size is as follow.

Profile	Codec	Frame Size	
		IPv4	IPv6
Voice	VoIP G.711	138	158
	VoIP G.723.1	82	102
	VoIP G.729	78	98
Video	All codec	1374	1394
Data	-	Programmable from 64 ^a to 16000 ^b	

- a. The minimum frame size will be adjusted according to the frame structure and components selected. The following table lists each component that may affect the minimum frame size value.
 - b. The maximum frame size is limited to 10000 for 10/100/1000Mbps electrical interface.
- For **Random** type, the frame size range is from 64 to 1518 bytes. However, the minimum frame size will be adjusted according to the frame structure and components selected. The following table lists each component that may affect the minimum frame size value. The maximum frame size value is also adjusted for VLAN (+4 bytes per VLAN).

Test Setup - Test Configurator, Timer, and System

Streams - Profile

- For **Sweep** type, the first frame is generated starting with the minimum number of bytes defined then each subsequent frame is incremented by 1 byte until the maximum number of bytes is reached and start over with minimum. The frame size range is from 64 to either 10000 bytes for electrical interfaces or 16000 bytes for optical interfaces; default is 1518 bytes. However, the minimum frame size will be adjusted according to the frame structure and components selected. The following table lists each component that may affect the minimum frame size value.

The following table lists each component that may affect the minimum frame size value.

Component	Description
VLAN	4 bytes per VLAN (up to 2 VLAN)
MPLS	4 bytes per label (up to two labels)
EoE Header	16 bytes
EoE VLAN	4 bytes
PBB-TE Header	18 bytes
B-VLAN	4 bytes
UDP	8 bytes
Ethernet Header	14 bytes
IPv4	20 bytes
IPv6	40 bytes

Shaping

- **TX Mode** allows the selection of the transmission mode for the selected stream when **Data** profile is selected. The TX Mode is forced to **Continuous** for Voice and Video profiles and when using **Provider Encapsulation**.

Continuous (default) transfers the selected frame continuously according to the selected percentage of bandwidth.

n-Frame transfers the selected number of frames.

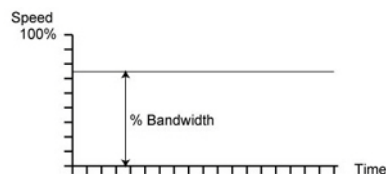

Burst transfers the selected frame at maximum bandwidth for the selected **Burst Duty Cycle** over the **Period**.

n-Burst transfers the selected number of Burst.

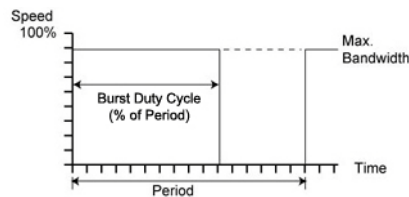

Ramp transfers the selected bandwidth in a stair shape according to the selected step time, number of steps, and maximum bandwidth.

n-Ramp transfers the selected number of Ramp.

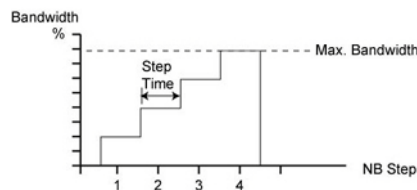

- **TX Rate / Max TX Rate** indicates the transmission rate for Voice and Video profiles, and allows entering the transmission rate for Data profile. The available stream transmission rate will be calculated according to the selected TX Mode. The default setting is 100 percent for all interfaces at the exception of 10Gig-E WAN which is 92.8571 percent (depending on the frame format).

Unit choices are: **%** (default), **Mbit/s**, **Gbit/s**, **frame/s**, **IFG**. However **frame/s** and **IFG** are not available for **Random** and **Sweep** frame sizes.

Test Setup - Test Configurator, Timer, and System

Streams - Profile

- **Customer Frame TX Rate**, available when using **Provider Encapsulation**, indicates the customer frame TX rate based on the **TX Rate** defined.
- **Frame Count** is only available with n-Frame Transmit Mode. Enter the frame count number: **1** (default) to **267857142857**.
- **Shaping** button

For **Burst** and **n-Burst** TX modes.

- **Burst Duty Cycle (%)** represents the burst duration within the burst period: **1** to **100** percent (default is **50** percent).
- **Period** represents the burst pattern duration: **1** to **8000** milliseconds (default is **1000** ms).
Unit choices are **ms** (default) and **s**.
- **Burst Count**, available with n-Burst TX Mode, represents the number of times the burst will be repeated: **1** (default) to **255**.

For **Ramp** and **n-Ramp** TX modes.

- **Ramp Nb. of Steps** represents the number of steps within the ramp: **2** to **100** (default is **10**).
- **Step Time** represents the duration of each step: **100** to **8000** milliseconds (default is **1000** ms).
Unit choices are **ms** (default) and **s**.
- **Ramp Cycle Count**, available with n-Ramp TX mode only, represents the number of times the ramp will be repeated: **1** (default) to **255**.

- **Total TX Rate** indicates the percentage of the total line utilization which is the sum of all TX rate enabled streams.

Note: *The Individual stream can be enabled/disabled even when the test is started and running. The streams can be enabled one after the other, up to 16, as long as the maximum rate is not reached. For example, if the first stream is using the full rate available, then no other stream can be enabled. However, if the first enabled stream uses half rate, then at least another stream can be enabled using up to half rate. Thus, to enable a second stream, first set the TX rate value within the non-used rate, then enable it. A stream cannot be enabled if its MAC address is not valid (it can be either not resolved or wrongly entered).*

- **Link Capacity** indicates the total rate available for traffic generation.

QoS Metrics

Note: *QoS Metrics settings apply to all streams.*

- **Global Pass/Fail Verdict** check box when selected (default) enables the pass/fail verdict for all streams.
- **Global Thresholds Type** button
 - **Throughput** allows selecting if the verdict is based on the **Current Throughput** (default) or **Average Throughput**.
 - **Frame Loss** allows selecting if the verdict is based on a frame loss **Count** (default) or **Rate**.
 - **Out-of-Sequence** allows selecting if the verdict is based on an Out-of-Sequence **Count** (default) or **Rate**.
- **Throughput (%)** check box when selected enables the throughput pass/fail verdict and allows setting the minimum and maximum threshold values.

Test Setup - Test Configurator, Timer, and System

Streams - Profile

- **Customer Frame Throughput.** available when using **Provider Encapsulation**, displays the calculated customer frame throughput minimum and maximum thresholds based on the throughput values.
- **Frame Loss Count/Rate** check box when selected enables the Frame Loss pass/fail verdict and allows setting the threshold of frame that are lost.

For **Count**, enter the maximum count of frame that are lost before declaring a fail verdict: **0** (default) to **999999999**.

For **Rate**, enter the maximum rate of frame that are lost before declaring a fail verdict: **1.0E-14** (default) to **1.0E00**.

- **Out-of-Sequence Count/Rate** check box when selected enables the Out-of-Sequence pass/fail verdict and allows setting the threshold of frames that are Out-of-Sequence.

For **Count**, enter the maximum count of frames that are Out-of-Sequence before declaring a fail verdict: **0** (default) to **999999999**.

For **Rate**, enter the maximum rate of frames that are Out-of-Sequence before declaring a fail verdict: **1.0E-14** (default) to **1.0E00**.

- **Jitter (ms)** check box when selected enables the Jitter verdict and allows setting the maximum Jitter in ms before declaring a fail verdict.
- **Latency (ms)** check box when selected enables the Latency verdict and allows setting the maximum Latency in ms before declaring a fail verdict.

SyncE

From the **Test** menu, tap **Setup, Test Configurator**, and the **SyncE** test block.

ESMC Monitoring

- **ESMC** (Ethernet Synchronization Message Channel) is a live value monitored even when the test is not started.

An arrow next to the ESMC label indicates that ESMC valid information frames are received or not.

- A green arrow indicates that at least one ESMC valid information frame, containing a valid FCS, was received within a second in the last 5-second interval.
- A red arrow indicates that no ESMC valid information frames were received for more than 5 seconds.
- A gray arrow indicates awaiting incoming data to provide a status.
- **Received QL** indicates the last Quality Level received. The **Received QL** is a live value monitored even when the test is not started.
- **QL Mismatch Monitoring** check box when selected (default) enables the Quality Level mismatch monitoring. The quality level characterizes the clock quality in terms of network synchronization.
- **Expected QL** available when the **QL Mismatch Monitoring** check box is selected, allows the selection of the Expected Quality Level value. See page 450 for more information.

Test Setup - Test Configurator, Timer, and System

SyncE

- **Pass/Fail Verdict** check box when selected (default) enables the use of the pass/fail verdict. The global pass/fail verdict is based on the following criteria: **ESMC Rate Threshold** (when enabled), **QL Mismatch Monitoring** (when enabled), **ESMC Loss**, or **Link Down**.
- **ESMC Rate Threshold** check box when selected (default) enables the ESMC rate threshold monitoring which will declare a Fail verdict when the ESMC frame rate is outside the range of 0.8 to 10.2 frames/s.

ESMC Generation

- **Generated QL**

The **Generated QL** check box when selected (default) enables the generation of the selected QL message.

The **Generated QL** field allows the selection of the QL message that will be generated. See page 450 for the list of QL message (default is **QL-EEC2/ST3**).

Note: For 1GE Electrical interface using **Local Clock** set to **Slave**, the **Generated QL** is not configurable and is set to **QL-DNU/DUS** with its check box selected.

- **QL Rate (frame/s)** defines the frame rate at which the ESMC transmit the QL message value: **1** (default), **5**, or **10** frames per second. For 1GE Electrical interface using **Local Clock** set to **Slave**, the **QL Rate** is not configurable and is set to **1** frame/s.

Restore SyncE Defaults

Reverts the SyncE test application to its default factory settings.

System

From the **Test** menu, tap **Setup**, and **System**.

Factory Default

- **Restore Default** button restores the factory default settings for all test applications.
- **Restore Default at Start-Up** check box when cleared (default), reloads the last configuration settings when the application is launched; when selected, the factory settings are restored.

Remote Control

User Information allows a user to leave a message to other users connected on the same module. Up to 80 characters are allowed.

Time Zone allows the selection of the time zone source.

- **Local** (default) uses and displays the time from the 88000 Series module or from the PC for a Remote ToolBox session.
- **Test Equipment**, available for a Remote ToolBox session, uses and displays the time from the 88000 Series module.

TA-SFP28

Gives the transceiver adapter insertion counter and information on the inserted transceiver module.

Note: *Only available with FTBx-88260 modules.*

From the **Test** menu, tap **Setup, Test Configurator**, tap on the interface block and on the transceiver adaptor (**TA-...**) tab.

Port

- **Transceiver Adaptor Insertion Counter** indicates the number of time a transceiver adaptor module has been inserted into this FTBx-88260 module port over its limit of 1000 insertions.
- **Transceiver Adaptor Parameters** are as follows:
 - **ID** indicates the name of the TA module (**TA-...**).
 - **Serial Number** indicates the serial number of the TA module.
 - **Revision** indicates the hardware revision of the TA module.
 - **Battery** indicates the status level of the battery: **Good, Low, or Depleted**.
 - **Optical Module Insertion Counter** indicates the number of time an optical transceiver has been inserted into this transceiver adaptor module port over its limit of 250 insertions.

TCP Throughput

From the **Test** menu, tap **Setup**, **Test Configurator**, and tap on the test block.

TCP Mode

Since two units are required to perform a TCP Throughput test, one unit must be the source (**Local**) unit and the other one the destination (**Remote**). Set the TCP Mode on both units: **Local** (default) or **Remote**.

TCP Connection Configuration

- **Remote IP Address**, available with **Local** TCP mode, allows entering the IP address of the remote unit.
- **Quick Ping** button automatically starts the quick Ping utility for the remote IP address and provides either a successful or failed result. The quick Ping uses 3 attempts, a Delay of 1 second, a Timeout of 2 seconds, and a Data Size of 32 Bytes. Refer to *Ping & Trace Route* on page 605 for more options.
- **Accept Connection from IP**, available with **Remote** TCP mode, allows entering the IP address of the local unit. The IP address **0.0.0.0** (default) listens to any TCP stream.
- **IP TOS/DS**, available with **Local** TCP mode, is configurable from **0x00** (default) to **0xFF**.
- **TCP Port**, available with **Local** and **Remote** TCP modes, allows the selection of the TCP port number: **0** to **65535** (default is **50201**). For the local unit, the specified TCP port will be used for the TCP initialization algorithm with the remote unit. The following TCP segments sent by the local unit will use the TCP port number replied by the remote unit.

TCP Throughput Configuration

Note: *TCP Throughput Configuration is only available on the local unit.*

- **Initial Window Size**¹ is the window size that is used when the test is started: **1024** Bytes to **65536** KBytes (default is **2** KBytes). The Initial Window Size value must be between the **Minimum Window Size** and the **Maximum Window Size** values.
- **Minimum Window Size**¹ is the minimum window size used for the test: **1024** Bytes to **65536** KBytes (default is **1** KBytes).
- **Maximum Window Size**¹ is the maximum window size used for the test: **1024** Bytes to **65536** KBytes (default is **64** MBytes).
- **Rate Unit** allows selecting the unit that will be used to set the Throughput Pass/Fail Verdict Threshold and throughput results: % (default) or **MBit/s**.
- **Throughput Pass/Fail Verdict** check box when selected (default) enables the throughput verdict.
- **Threshold** allows setting the pass/fail verdict threshold value: **0** to **100** % (default).

Restore TCP Throughput Defaults

Reverts the TCP Throughput test application to its default factory settings.

1. The entered value will be rounded to the closest multiple of 1024 Bytes. Unit choices are Bytes, KBytes (default), and MBytes.

Test Sequence (iOptics)

From the **Test** menu, tap **Setup**, and **Test Configurator**.

- **Power Threshold (W)** indicates the power consumption threshold based on the power level/class detected including uncertainty from the selected transceiver to declare the pass/fail verdict. Not available on 8870 and 8880 modules.

Power Consumption Pass/Fail Verdict check box when selected (default) enables the power consumption pass/fail verdict based on the **Power Threshold (W)** value. In the case where a vendor optical devices overcome the Power Class they are assigned to, clear this check box to avoid reporting a fail verdict.

- **Temp. Threshold (°C)** allows selecting the temperature threshold to declare the pass/fail verdict: **0** to **75 °C** (default is **70 °C**).
- **TX Power Range (dBm)** indicates the optical device TX operational range to declare the pass/fail verdict.
- **RX Power Range (dBm)** indicates the optical device RX operational range to declare the pass/fail verdict.
- **BERT Duration** is the time duration of the bit error test:
1 minute (default), **2, 3, 4, 5,** or **30 minutes**.
- **BERT Threshold** indicates the bit error test threshold (set to **0**) to declare the pass/fail verdict.
- **Skew Threshold (Bits)**, available with parallel interfaces, indicates the skew threshold that is automatically set based on the rate to declare the pass/fail verdict.

Timer

Allows starting and/or stopping automatically the test at a given time or for a specific duration.

From the **Test** menu, tap **Setup**, and **Timer**.

Timer

Note: *For RFC 2544 and RFC 6349, only **Start Time** and the **ARM** button are available.*

- **Duration:** Selects the test duration based on the test start time. The test start time can be either the time the user starts the test or the time the test is automatically started when the start time is enabled. The **Duration** check box has to be selected to be included in the test timer. Choices are **15 minutes** (default), **1, 2, 4, 6, 12, 24, 72 hours, 7 days**, and **User Defined**.

When **User Defined** is selected, the field next to it becomes available to enter the test duration using the format: dd:hh:mm:ss.

Note: *Duration cannot be enabled while stop time is enabled. When the test is started while duration is enabled, the stop time is calculated and the Stop Time field is updated to indicate the time the test will stop.*

- **Start Time** selects the time the test will automatically start. The **Start Time** check box has to be selected to be included in the test timer.

Note: *A valid start time has to be subsequent to the current time.*

- **Stop Time** selects the time the test will automatically stop. The **Stop Time** check box has to be selected to be included in the test timer.

Note: *A valid stop time has to be subsequent to the current time or to the start time, when enabled. The stop time must not exceed 30 days based on the start time. The stop time cannot be enabled while **Duration** is enabled.*

- **ARM** button, available when the **Start Time** check box is selected (cleared by default), enables the start test timer. Not available while the test is running. It is not possible to start the test case when the start time is armed.

Note: *An icon is displayed in the global test status area indicating that the timer is enabled. **Armed** is displayed when the test start time is armed while the test is not started. Refer to Global Indicator on page 31 for more information.*

Traces (OTN)

For OTN BERT and OTN-SONET/SDH BERT: From the **Test** menu tap **Setup, Test Configurator**, tap on the interface block, and on the **Traces** tab.

For Multi-Channel OTN: From the **Test** menu, tap **Setup, Test Configurator**, tap on either:

- the interface block, and on the **Traces** tab to configure the higher ODU layer.
- the test block (**ODU Channels**), and on the **Traces** tab to configure the lower ODU layer. Traces settings apply to all channels unless otherwise indicated.

OTUx, ODUx, and TCM Buttons

Tap on either OTUx or an ODUx button. For ODUx when TCM is enabled (see **Modify TCM** on page 306), tap on a TCMx button to select a TCM level. TCM is not available with Multi-Channel OTN.

SM/PM/TCM TTI Traces

Note: *The TTI Traces are configurable for SM (OTUx), PM (ODUx), and TCM (ODUx when TCM is enabled; see **Modify TCM** on page 306).*

- **Overwrite** check box when selected generates the defined messages. Only available with **Through Intrusive** topology and applies only to the OTU and ODU top layers.
- **Generated Message**
Allows editing the SAPI, DAPI and Operator Specific messages to be generated.

► Expected Message

Allows editing the expected SAPI, and DAPI messages. The expected message settings are coupled with the **Expected Message** from *Traces - OTN* on page 525. For Multi-Channel OTN lower ODU layer, expected traces apply to all channels but may be overwritten individually per channel from *Traces - OTN* on page 525; In this case the  icon appears next to the expected message indicating that at least one channel uses a different message.

- **SAPI** (Source Access Point Identifier) corresponds to the TTI bytes 0 to 15. A maximum of 16¹ characters is allowed. NULL (all 0's) characters are automatically appended to the message for bytes that are not defined. The expected SAPI message is available when the **SAPI OTU/ODU-TIM** check box is selected.

TTI Traces	Default Message ^a	
	OTN BERT OTN-SONET/SDH BERT Multi-Channel OTN (higher ODU layer)	Multi-Channel OTN (lower ODU layer)
SM	EXFO OTU SAPI	EXFO OTU SAPI
PM	EXFO ODU SAPI	XFO ODU SAPI ^b
TCM	EXFO TCMi SAPI	

- a. The default message contains a NULL (all 0's) character preceding it. NULL (all 0's) characters are automatically appended to the message for bytes that are not defined.
- b. The channel number is automatically appended to the generated/expected message.

1. For Multi-Channel OTN lower ODU layer, a maximum of 13 characters are allowed since the channel number is automatically appended to the message.

Test Setup - Test Configurator, Timer, and System

Traces (OTN)

- **DAPI** (Destination Access point Identifier) corresponds to the TTI bytes 16 to 31. A maximum of 16¹ characters is allowed. NULL (all 0's) characters are automatically appended to the message for bytes that are not defined. The expected DAPI message is available when the **DAPI OTU/ODU-TIM** check box is selected.

TTI Traces	Default Message ^a	
	OTN BERT OTN-SONET/SDH BERT	Multi-Channel OTN
SM	EXFO OTU DAPI	EXFO OTU DAPI
PM	EXFO ODU DAPI	XFO ODU DAPI ^b
TCM	EXFO TCMi DAPI	

- The default message contains a NULL (all 0's) character preceding it. NULL (all 0's) characters are automatically appended to the message for bytes that are not defined.
- The channel number is automatically appended to the message.

- **Operator Specific** corresponds to the TTI bytes 32 to 63. A maximum of 32 characters are allowed. NULL (all 0's) characters are automatically appended to the message for bytes that are not defined.

TTI Traces	Default Message ^a	
	OTN BERT OTN-SONET/SDH BERT	Multi-Channel OTN
SM	EXFO OTU OPERATOR SPECIFIC	EXFO OTU OPERATOR SPECIFIC
PM	EXFO ODU OPERATOR SPECIFIC	XFO ODU OPERATOR SPECIFIC
TCM	EXFO TCMi OPERATOR SPECIFIC	

- NULL (all 0's) characters are automatically appended to the message for bytes that are not defined.

- **SAPI OTU/ODU/TCM-TIM** check box, when selected (cleared by default), allows editing the expected Source Access Point Identifier (SAPI) and also enables OTU/ODU/TCM-TIM alarm monitoring.
- **DAPI OTU/ODU/TCM-TIM** check box, when selected (cleared by default), allows editing the expected Destination Access Point Identifier (SAPI) and also enables the OTU/ODU/TCM-TIM alarm monitoring.

Traces (SONET/SDH)

For SONET/SDH BERT, from the **Test** menu, tap **Setup, Test Configurator**, the interface block, and on the **Traces** tab.

For OTN-SONET/SDH BERT, from the **Test** menu, tap **Setup, Test Configurator**, the protocol block, and on the **Traces** tab.

Note: *Selecting a Trace byte to be generated will automatically update the corresponding OH byte. Refer to OH - SONET/SDH on page 591 for more information.*

Traces

➤ **Section/RS (J0), STS/AU/TU-3 Path (J1), and VT/TU Path (J2)**

Format: Allows the selections of the J0/J1/J2 format: **1 Byte** (default), **16 Bytes**, or **64 Bytes** format.

Generated: When the 16 bytes or 64 bytes format is selected, enter the J0/J1/J2 trace value/message to be generated.

Default values/messages

Format (bytes)	Traces	J0/J1/J2
1	01 ^a	J0/J1/J2
16	EXFO SONET/SDH	J0/J1/J2
64	EXFO SONET/SDH Analyzer Section/RS trace test message	J0
	EXFO SONET/SDH Analyzer high order path trace test message	J1 (STS/AU)
	EXFO SONET/SDH Analyzer low order path trace test message	J1 (TU-3)/J2

a. Hexadecimal value. Refer to *OH - SONET/SDH* on page 591 to change this value.

Note: 16-bytes selection allows typing up to 15 bytes (a CRC-7 byte will be added in front for a total of 16 bytes). 64-bytes selection allows typing up to 62-bytes (<C_R> and <L_F> bytes will be added at the end for a total of 64-bytes). Traces values should be ASCII suitable characters including the ITU T.50 Characters on page 40.

- **TIM-S/RS-TIM, TIM-P/HP-TIM, TIM-V/LP-TIM:** Enables the corresponding Trace Identifier Mismatch for the expected message defined. These settings are coupled with the *Result - Traces/Labels* configuration (refer to *Traces - SONET/SDH* on page 527).

Format: Allows the selection of the expected format:

16 Bytes (default), or **64 Bytes**.

Expected: Allows entering the expected J0 trace message for TIM-S/RS-TIM, J1 for TIM-P/HP-TIM, and J2 for TIM-V/LP-TIM. See *Default values/messages* on page 336.

TCM Access Point Identifier

Note: Available when TCM is enabled from the Signal - Signal Configuration (SONET/SDH) on page 307.

- **STS/AU Path (N1), and VT/TU Path (Z6 or N1 (TU-3))**
Enter the N1/Z6 value/message to be generated.
- **TC-TIM-P/HPTC-TIM/TC-TIM-V/LPTC-TIM:** Enables the corresponding TCM Access Point Identifier for the expected message defined. These settings are coupled with the Traces configuration from *Traces - SONET/SDH* on page 527.

Wander

From the **Test** menu, tap **Setup, Test Configurator**, and the **Wander** test block.

Test

- **Sampling Rate** is the time error measurement sampling rate: **30 samples/s** (default), **20 samples/s**, **10 samples/s**, **5 samples/s**, and **1 sample/s**. Only **1 sample/s** is supported with 1PPS rate.
- **Maximum Test Duration** displays the maximum test duration based on the selected sampling rate.
- **Mask** selects the MTIE/TDEV ITU mask for Time Error / Time Interval Error pass/fail validation: None (default), or one of the following:

Mask	MTIE	TDEV
G.811- Primary Reference Clock (PRC)	X	X
G.812- Type I Node Clock (SSU) - Constant Temperature	X	X
G.812- Type I Node Clock (SSU) - Variable Temperature	X	-
G.812- Type II and III Node Clock (SSU) - Constant Temperature	X	X
G.813- Option 1 SDH Equipment Clock (SEC) - Constant Temperature	X	X
G.813- Option 1 SDH Equipment Clock (SEC) - Variable Temperature	X	-
G.813- Option 2 SDH Equipment Clock (SEC) - Constant Temperature	X	X
G.823- Primary Reference Clock (PRC)	X	X
G.823- Synchronization Supply Unit (SSU)	X	X
G.823- SDH Equipment Clock (SEC)	X	X
G.823- PDH Synchronization Interface	X	X
G.824- 1544 kbit/s Reference Interface	X	X
G.824- 1544 kbit/s Reference Interface for Option 2 SEC	-	X
G.8261- CES Case 1 - 2048 kbit/s (MRTIE)	X	-
G.8261- CES Case 1 - 1544 kbit/s	X	-

Mask	MTIE	TDEV
G.8261- CES Case 2A - 2048 kbit/s (MRTIE)	X	-
G.8261- EEC Option 1 - SyncE Interface	X	X
G.8261- EEC Option 2 - SyncE Interface	-	X
G.8261.1- PEC-Slave Frequency Case 3	X	-
G.8262- EEC Option 1- SyncE - Constant Temperature	X	X
G.8262- EEC Option 1- SyncE - Variable Temperature	X	-
G.8262- EEC Option 2- SyncE - Constant Temperature	X	X
G.8263- PEC-Slave Frequency - Constant Temperature	X	-
G.8263- PEC-Slave Frequency - Variable Temperature	X	-
G.8271.1- Dynamic Time Error	X	-

- **cTE Averaging Period (s)** defines the averaging period used to calculate the constant Time Error (cTE) value over a specific period of time: **Elapse time** (default), **100 s**, **500 s**, **1000 s**, **10000 s**.
- **dTE_H Observation Period (s)** defines the observation period used for qualifying the Time Error after High-Pass filtering 0.1 Hz: **100 s**, **500 s**, **1000 s**, **10000 s** (default).
- **Cable Delay Compensation (ns)**, available for time error measurements, allows manual compensation of external cable delay asymmetry: **-1000 ns** to **1000 ns** (**0 ns** by default).
- **Duration** check box, when selected (cleared by default), allows selecting/entering the test duration: **15 minutes**, **1/2/4/6/12/24/72 hours**, or **User Defined** (1 second up to 30 days depending on the selected **Sampling Rate**).

Note: *Once the test completes (after the duration is reached or when manually stopped), MTIE calculation may take some time depending on the test duration and sampling rate used.*

Verdict

The following pass/fail verdict are available and configurable when applicable.

- **MAX Absolute TE (ns)** check box when selected, allows selecting the maximum absolute time error threshold value: **50 ns** to **2000 ns** (default is **1100 ns**). Only available with 1PPS.
- **Max dTE_H pk-pk (ns)** check box when selected, allows selecting the maximum dynamic time error (after High-Pass filtering 0.1 Hz) peak-to-peak threshold value: **20 ns** to **400 ns** (default is **200 ns**). Only available with 1PPS.
- **Max cTE (ns)** check box when selected, allows selecting the maximum constant time error threshold value: **15 ns** to **600 ns** (default is **600 ns**). Only available with 1PPS.

Note: *MTIE and TDEV thresholds are disabled when the **Mask** selection is set to **None**.*

- **MTIE** check box when selected (default) reports the Maximum Time Interval Error (MTIE) verdict.
- **TDEV** check box when selected (default) reports the Time Deviation (TDEV) verdict.

Restore Wander Defaults

Reverts the Wander test application to its default factory settings.

9 Test Results

The Test Results menu offers the following structure:

Intelligent Apps test applications

Tab	Test Application		Page
	iOptics	iSAM	
Logger	X	X	432
Summary	491	493	<---

Transport test applications

Tab	Available with						Page
	OTN BERT	Multi-Channel OTN	OTN-SONET/SDH BERT	SONET/SDH BERT	DSn/PDH BERT	NI/CSU Emulation	
Alarms/Errors	X	-	X	X	X	-	346
FTFL/PT or PT	X	X	X	-	-	-	421
GFP-F/GFP-T	X	-	-	-	-	-	423
Labels	-	-	X	X	-	-	427
Logger	X	X	X	X	X	X	432
OTL-SDT	X	-	X	-	-	-	437
Performance Monitoring	X	-	X	X	X	-	439
SDT	-	X	-	-	-	-	457
Summary	467	499	467	467	467	501	<---
Traces	525	525	525 / 527	527	-	-	<---
Traffic - Ethernet	X	-	-	-	-	-	528

Test Results

Ethernet test applications

Tab - Subtab	Test Application										Page
	a	b	c	d	e	f	g	h	i	j	
Alarms/Errors	X	X	X	X	X	X	X	X	X	-	346
Graph	-	-	X	-	-	-	-	-	-	-	426
Link OAM	-	-	-	-	-	-	-	-	X	-	428
Logger	X	X	X	X	X	-	X	X	X	-	432
S-OAM / MPLS-TP OAM	-	-	-	-	-	-	-	-	X	-	452
Service Configuration - Burst	X	-	-	-	-	-	-	-	-	-	459
Service Configuration - Ramp	X	-	-	-	-	-	-	-	-	-	460
Service Performance	X	-	-	-	-	-	-	-	-	-	462
Streams - Customer Frame Throughput	-	-	-	-	X	-	-	-	-	-	466
Streams - Frame Loss / Out-of-Sequence	-	-	-	-	X	-	-	-	-	-	464
Streams - Jitter	-	-	-	-	X	-	-	-	-	-	464
Streams - Latency	-	-	-	-	X	-	-	-	-	-	465
Streams - MPLS	-	-	-	-	X	-	-	-	-	-	436
Streams - Throughput	-	-	-	-	X	-	-	-	-	-	466
Summary	485	505	502	467	519	467	467	516	497 508	479	<---
Traffic - Ethernet	X	X	X	X	X	X	X	X	X	-	528
Traffic - Flow Control	-	X	X	-	X	-	X	X	-	-	531
Traffic - Graph	-	-	-	-	X	-	X	-	-	-	533
Traffic - MPLS	-	-	-	-	-	-	X	-	-	-	436
Traffic - S-OAM / MPLS-TP OAM	-	-	-	-	-	X	-	-	X	-	534
Window Sweep	-	X	-	-	-	-	-	-	-	-	536
WIS	X	-	X	X	X	X	-	-	X	-	537

- a. EtherSAM
- b. RFC 6349
- c. RFC 2544
- d. EtherBERT
- e. Traffic Gen & Mon
- f. Smart Loopback
- g. Through Mode
- h. TCP Throughput
- i. Carrier Ethernet OAM
- j. Cable Test

Sync test applications

Tab	Test Application			Page
	1588 PTP	SyncE	Wander	
Alarms/Errors	X	X	X	346
Analysis - MTIE/TDEV	-	-	X	417
Analysis - Time Error	-	-	X	419
Logger	X	X	X	432
PTP Stats	X	-	-	446
Quality Level (1588 PTP)	X	-	-	448
Quality Level (SyncE)	-	X	-	450
Summary	474	513	521	<---
Traffic - Ethernet	X	X	-	528

Fibre Channel test application

Tab	Test Application		Page
	Fibre Channel BERT		
Alarms/Errors	X		346
Logger	X		432
Summary	X		488

Wireless Test Application

Tab	Test Application		Page
	CPRI/OBSAI BERT		
	CPRI	OBSAI	
Alarms/Errors ^a	X	X	346
Logger	X	X	432
Messages	-	X	434
Summary	X	X	467

a. Only available for Framed L2.

Alarms/Errors Overview

Current and history alarms/errors are displayed using different background colors as defined in the following table.

Background color	Alarm/Error	Description
Gray	Current	No test result available.
	History	
Green	Current	No alarm/error has occurred in the last second.
	History	No alarm/error has occurred during the test.
Red	Current	An alarm/error occurred in the last second.
	History	
Amber	History	At least one alarm/error has occurred during the test.



- **Seconds** gives the total number of seconds in which one or more alarm/error occurred.
- **Count** gives the number of occurrences of a specific error. The count is displayed using integer value; exponential value (for example: 1.00000E10) is used when the count is bigger than the field display capacity.
- **Rate** calculates and displays the error rate. The rate is expressed using the exponential format with two decimal digits (example: 1.23E-04).

Note: When an alarms/errors group displays a magnifying icon, tapping on it gives more information on alarm/error like Second, Count, and Rate.

Pass/Fail Verdict

Note: The verdict is not displayed when disabled or unavailable.

The Pass/Fail verdict is represented by the following icons:

Icon	Verdict	Description
	PASS	Result value meet the configured threshold criterion.
	FAIL	Result value does not meet the configured threshold criterion.

Statistic Values

- **Current** indicates the average measurements in the last second.
- **Last** indicates the result of the last measurement.
- **Minimum** indicates the minimum value recorded.
- **Maximum** indicates the maximum value recorded.
- **Average** indicates the average value.

P1 and P2 Buttons

The **P1** and **P2** buttons, available with **Dual Port** topology, allow respectively displaying the alarms/errors for port #1 (**P1**) or port #2 (**P2**).

Channel

Available with Multi-Channel OTN, allows the selection of the channel number.

Test Results

Alarms/Errors Overview

Alarms/Errors

From the **Test** menu, tap **Results**, and the **Alarms/Errors** tab. Depending on the test structure, the Alarms/Errors page may be split in different tabs such as OTN, GFP-T/GFP-F, and Ethernet; tap on the desired tab when required.

Alarms/errors blocks containing the magnifier (+) icon in its title, opens a zoomed view giving more details like alarms/errors for each lane (parallel interface), errors in seconds, count, and rate.

When there is not enough room on the page to display the error in seconds, count, and rate, the error is displayed in **Seconds** per default. To select another unit, tap on the unit's button and select either **Seconds** (default), **Count**, or **Rate**.

Total, available with certain errors (parallel interface), indicates the total of all lanes when **Count** or **Rate** unit is selected.

The following table lists the availability of alarms/errors per layer for TX and RX.

Layer	Alarms/Errors		Page
	TX/RX	RX only	
BER	Pattern Loss	No Traffic, Client Frequency	350
	Bit Error, Pattern Error	Mismatch '0', Mismatch '1', Frame Loss, Out-of-Seq.	
CLOCK	-	LOC, LOPPS-L, LOPPS-R	351
CPRI	LOF, R-LOS, R-LOF, RAI, SDI	Link Down	352
	FAS	-	
DS1	AIS. OOF, RAI	-	353
	CRC-6, Framing Bit	-	
DS3	AIS, Idle, OOF, RDI	-	354
	CP-BIT, FEBE, F-Bit, P-Bit	-	
E1	AIS, LOF, RAI, LOMF, RAI MF, TS16 AIS	-	355
	FAS	CRC-4, E-Bit	
E2	AIS, LOF, RAI	-	356
E3	FAS	-	357
E4		-	358
Ethernet	Link Down, Remote Fault, Local Fault ^a	Hi-BER, Local Fault Det., Local Fault Rcd.	359
	Block, FCS, Symbol	Alignment, False Carrier, Idle, Jabber, Oversize, Runt, Undersize	
Ethernet - PCS	L Deg SER Rcd, R Deg SER	LOA, Inv. Mapping, L Deg SER Det	362
	66B Block, FEC-UNCOR-CW, FEC-COR-CW	-	
Ethernet - PCS Lanes	-	LOBL, LOAML, Exc. Skew	364
	Block, Inv. Marker, PCS BIP-8, FEC-SYMB	-	
FEC	CORR-BIT, CORR-CW, CORR-SYM, STRESS, UNCORR-CW	CORR, UNCORR	386
Fibre Channel	-	Link Down, Local Fault Detected, Local Fault Received, Remote Fault	366
	-	Symbol, Block, FCS, Oversize, Undersize	

Test Results

Alarms/Errors Overview

Layer	Alarms/Errors		Page
	TX/RX	RX only	
GFP	LFD, DCI, FDI, RDI, LOCS, LOCCS, User-Defined CMF	EXM, UPM, Reserved CMF	368
	cHEC-CORR, cHEC-UNCORR, tHEC-CORR, tHEC-UNCORR, eHEC-CORR, eHEC-UNCORR, SB-CORR (Post), SB-CORR (Pre), SB-UNCORR, 10B_ERR, pFCS	-	
GMP	-	OOS	373
	-	Cm-CRC-8, CnD-CRC-5	
Interface	LOS	LOC Lane, Frequency, LOC	374
	BPV, EXZ, CV, K30.7		
IP/UDP/TCP	-	IP Chksum, UDP Chksum, TCP Chksum	376
MPLS-TP OAM	RDI, AIS, LCK, C-LOS, C-FDI, C-RDI, C-DCI ^a	Loss Continuity, Mismatch, Unexp MEG Lvl, Unexp MEP, Unexp Period	393
OBSAI	LOF	Link Down, RP3 Address Mismatch	377
	FAS	CRC	
ODUx	LOFLOM, AIS, OCI, LCK, BDI, FSF, BSF, FSD, BSD	TIM	378
	BEI, BIP-8	-	
ODUx-TCM	BDI, BIAE, IAE, LTC	TIM	381
	BEI, BIP-8	-	
OPUx	AIS, CSF, LOOMFI, MSIM, OOMFI, OMFI	PLM	383
OTL	LOF, LOL, LOR, OOF, OOR	Exc. Skew	385
	FAS, Inv. Marker	-	
OTUx	AIS, BDI, BIAE, IAE, LOF, LOM, OOF, OOM	TIM	386
	FAS, MFAS, BIP-8, BEI	-	
PTP	-	Loss Sync, Loss Announce, Unusable, Domain Mismatch, QL Mismatch	390
QoS Metrics	-	Frame Loss, Out-of-Seq.	391
Reference Signal	-	REF-FAULT	391
RS-FEC	-	FEC-LOA, FEC-LOAML	392
	For 88260: Inv-CW-Marker, FEC-CORR-CW, FEC-UNCORR-CW, FEC-SYMB	For 88200NGE: FEC-CORR-CW, FEC-UNCORR-CW, FEC-SYMB	

Layer	Alarms/Errors		Page
	TX/RX	RX only	
S-OAM	RDI, AIS, LCK, C-LOS, C-FDI, C-RDI, C-DCI ^a	Loss Continuity, Mismatch, Unexp MEG Lvl, Unexp MEP, Unexp Period	393
Section/Line / RS/MS	LOF-S/RS-LOF, SEF/RS-OOF, AIS-L/MS-AIS, RDI-L/MS-RDI	TIM-S/RS-TIM	397
	FAS-S/RS-FAS, B1, B2, REI-L/MS-REI	-	
STS-x / AU-x	AIS-P/AU-AIS, LOP-P/AU-LOP, UNEQ-P/HP-UNEQ, PDI-P, RDI-P/HP-RDI, ERDI-PCD/ERDI-CD, ERDI-PPD/ERDI-PD, ERDI-PSD/ERDI-SD	TIM-P/HP-TIM, PLM-P/HP-PLM	399
	B3, REI-P/HP-REI	-	
SyncE	-	ESMC Loss, QL Mismatch	401
TCM (SONET/SDH)	TC-UNEQ-P/HPTC-UNEQ, TC-LTC-P/HPTC-LTC, TC-IAIS-P/HPTC-IAIS, TC-ODI-P/HPTC-ODI, TC-RDI-P/HPTC-RDI, TC-UNEQ-V/LPTC-UNEQ, TC-LTC-V/LPTC-LTC, TC-IAIS-V/LPTC-IAIS, TC-ODI-V/LPTC-ODI, TC-RDI-V/LPTC-RDI	TC-TIM-P/HPTC-TIM, TC-TIM-V/LPTC-TIM	402
	TC-IEC-P/HPTC-IEC, TC-OEI-P/HPTC-OEI, TC-REI-P/HPTC-REI, TC-OEI-V/LPTC-OEI, TC-REI-V/LPTC-REI	TC-VIOL-P/HPTC-VIOL, TC-VIOL-V/LPTC-VIOL	
Transcoding	-	LOBL1027B, Hi-BER1027B, LOAML1027B	405
	Inv. Flag, MSEQV, OTN BIP-8, PCS BIP-8 Mask	POSV, SEQV	
VT/TU	AIS-V/TU-AIS, LOP-V/TU-LOP, RDI-V/LP-RDI, RFI-V/LP-RFI, UNEQ-V/LP-UNEQ, ERDI-VSD/LP-ERDI-SD, ERDI-VCD/LP-ERDI-CD, ERDI-VPD/LP-ERDI-PD	TIM-V/LP-TIM, PLM-V/LP-PLM	406
	-	BIP-2, REI-V/LP-REI	
WIS	SEF, LOP, AIS-L, RDI-L, AIS-P, RDI-P, LCD-P, LOP-P, UNEQ-P, ERDI-PSD, ERDI-PCD, ERDI-PPD	WIS Link Down, PLM-P	409

a. Available in TX only.

Test Results

Alarms/Errors Overview

BER

Alarms

- **No Traffic** (Available with EtherBERT or OTN BERT with EoOTN client)

RX:

Ethernet: No pattern traffic has been received in the last second.

Fibre Channel: No traffic is being transmitted when Login Management fails; a pop up displays **No Data is being transmitted on Port(s) <port number>. The Login process has failed.**

- **Pattern Loss**

RX:

Ethernet: More than 20 percent of bit errors are received or the reference sequence can be unambiguously identified as out of phase.

However, for OTU4 - **4 Unframed Physical Lanes** and 100GE - **4 Unframed CAUI-4** on 88200NGE, bit error rate is greater than 2.5×10^{-3} .

Fibre Channel: bit error is detected on four consecutive words.

- **Client Frequency** (Available for ODUflex with Pattern client)

RX: The received client signal rate doesn't meet the nominal bit rate configured ± 100 ppm (refer to *Nominal Bit Rate* on page 306).

Errors

- **Bit Error**

RX: There are logic errors in the bit stream (i.e., zeros that should be ones and vice versa).

- **Pattern Error**

RX: Indicates a block mismatch. Available with **Seed A** or **Seed B** pattern.

- **Mismatch '0'** (Available with EtherBERT and OTN BERT with EoOTN client; not available with 100GE - **4 Unframed CAUI-4** and OTU4 - **4 Unframed Physical Lanes** on 88200NGE.)

RX: There is a bit error on a binary '0' (for example ones that should be zeros) found in the test pattern only.

- **Mismatch '1'** (Available with EtherBERT and OTN BERT with EoOTN client; not available with 100GE - **4 Unframed CAUI-4** and OTU4 - **4 Unframed Physical Lanes** on 88200NGE.)

RX: There is a bit error on a binary '1' (for example zeros that should be ones) found in the test pattern only.

Clock

- **LOC** (Loss Of Clock)

RX: The module is unable to synchronize with the selected **Clock Mode**. No valid clock is generated/extracted to/from the EXT CLK port.

- **LOPPS-L** and **LOPPS-R** (Loss Of Pulse Per Second - Local/Remote) is only available with **Dual Test Set** in **One-Way Latency** measurement mode.

RX: Either no pulse is received or no pulse is received within 1 second $\pm 6.6 \mu s$ after the previous pulse. **LOPPS-R** is only monitored once the DTS connection is established.

Test Results

Alarms/Errors Overview

CPRI

Note: CPRI alarms/errors are only available for Framed L2.

Alarms

➤ **Link Down**

RX: Indicates that the start-up sequence is not in F (Operation) or G (Passive) link state.

➤ **LOF (Loss Of Frame)**

RX: The hyperframe alignment cannot be achieved or is lost.

➤ **R-LOS (Remote - Loss Of Signal)**

RX: Bit 3 of the Z.130.0 byte is set to 1.

➤ **R-LOF (Remote - Loss Of Frame)**

RX: Bit 4 of the Z.130.0 byte is set to 1.

➤ **RAI (Remote Alarm Indication)**

RX: Bit 1 of the Z.130.0 byte is set to 1.

➤ **SDI (Service Access Point Defect Indication)**

RX: Bit 2 of the Z.130.0 byte is set to 1.

Errors

➤ **FAS (Frame Alignment Signal)**

RX: Error detected in the start of hyperframe (byte different of K28.5 while not in LOF).

DS1

Note: *For Wander test application only **AIS** and **OOF** alarms are supported.*

Alarms

➤ **AIS** (Alarm Indication Signal)

RX: An unframed all-ones signal is received.

➤ **OOF** (Out-Of-Frame)

RX: Four consecutive frame bit errors are detected.

➤ **RAI** (Yellow) (Remote Alarm Indication)

RX:

SF framing: Bit 2 in each timeslot contains “0”.

ESF framing: Eight “ones” followed by eight “zeros” pattern is received continuously in the data link (FDL).

Errors

➤ **Framing Bit**

RX: An incorrect value appeared in a bit position reserved for framing.

➤ **CRC-6** (Cyclical Redundancy Check) is only available with ESF framing.

RX: One or more bit errors have been detected in a block of data through cyclical redundancy check.

Test Results

Alarms/Errors Overview

DS3

Alarms

- **AIS** (Alarm Indication Signal)
RX: The M-frame contains zeros (0) for C-bits, ones (1) for X-bits, 1010... repeating sequence with a one (1) immediately following any of the control bit positions for the information bits.
- **Idle** (DS3 Idle)
RX: Subframe 3 of the M-frame contains zeros (0) for the three C-bits, ones (1) for X-bits, 1100... repeating sequence with the first two bits following each control bit set to 11 for the information bits.
- **OOF** (Out-Of-Frame)
RX: Four consecutive frame bit errors are detected.
- **RDI** (Remote Defect Indicator)
RX: Both X-bits of the M-Frame are set to “0”.

Errors

- **CP-Bit** (Control-Bit)
RX: The three C-bits reserved to control bit stuffing are different of “111” and “000”.
- **F-Bit** (Framing-Bit)
RX: The frame alignment pattern received is different of “1001”.
- **P-Bit** (Parity-Bit)
RX: The P-Bits does not match the parity of all the information bits following the first X-Bit of the previous DS3 frame.
- **FEBE** (Far-End Block Error)
RX: The three FEBE bits reserved for framing or parity error detection contain the “000” pattern.

E1

Note: For Wander test application only **AIS** and **LOF** alarms are supported.

Alarms

Note: Only **AIS** is available when the framing is set to **Unframed**.

- **AIS** (Alarm Indication Signal)
RX: Two or less ZEROs are received in each of two consecutive double frame periods (512 bits).
- **LOF** (Loss Of Frame)
RX: Three consecutive incorrect frame alignment signals is received.
- **RAI** (Yellow) (Remote Alarm Indication)
RX: Bit 3 in timeslot 0 is set to “1”.
- **TS16 AIS** (TimeSlot 16 Alarm Indication Signal)
RX: Three or less ZEROs are received in each Timeslot 16 of two consecutive multiframes.
- **LOMF** (Loss Of MultiFrame)
RX: Two consecutive multiframes alignment signals (bits 1 through 4 of TS16 of frame 0) is received with an error.
- **RAI MF** (Remote Alarm Indication Multi-Frame)
RX: Bit 6 of timeslot 16 of frame 0 is set to “1”.

Test Results

Alarms/Errors Overview

Errors

- **FAS** (Frame Alignment Signal) is only available with **PCM30 CRC-4** or **PCM31 CRC-4** framing.
RX: Bits 2 to 8 of the frame containing the FAS differ from 0011011.
- **CRC-4** (Cyclical Redundancy Check)
RX: One or more bit errors are detected in a block of data through cyclical redundancy check.
- **E-Bit** (CRC-4 Error Signal) is only available with **PCM30 CRC-4** or **PCM31 CRC-4** framing.
RX: Bit 1 of sub-multiframe (SMF) II in frame 13 and/or 15 is set to 0 indicating a sub-multiframe error.

E2

Alarms

Note: Only AIS is available when the framing is set to Unframed.

- **AIS** (Alarm Indication Signal)
RX: An unframed all-ones signal is received.
- **LOF** (Loss Of Frame)
RX: Four consecutive incorrect frame alignment signals is received.
- **RAI** (Remote Alarm Indication)
RX: Bit 11 of a framed E2 is set to “1”.

Errors

- **FAS** (Frame Alignment Signal)
RX: Bits 1 to 10 of the first frame differ from 1111010000.

E3

Alarms

Note: *Only AIS is available when the framing is set to Unframed.*

- **AIS** (Alarm Indication Signal)
RX: An unframed all-ones signal is received.
- **LOF** (Loss Of Frame)
RX: Four consecutive incorrect frame alignment signals is received.
- **RAI** (Remote Alarm Indication)
RX: Bit 11 of a framed E3 is set to “1”.

Errors

- **FAS** (Frame Alignment Signal)
RX: Bits 1 to 10 of the first frame differ from 1111010000.

Test Results

Alarms/Errors Overview

E4

Alarms

Note: Only AIS is available when the framing is set to Unframed.

- **AIS** (Alarm Indication Signal)
RX: An unframed all-ones signal is received.
- **LOF** (Loss Of Frame)
RX: Four consecutive incorrect frame alignment signals is received.
- **RAI** (Remote Alarm Indication)
RX: Bit 13 of a framed E4 is set to “1”.

Errors

- **FAS** (Frame Alignment Signal)
RX: Bits 1 to 12 of the first frame differ from 111110100000.

Ethernet

Note: Available with EtherBERT, Wander, and OTN BERT with EoOTN client. For Wander test application only **Link Down** alarm is supported.

Alarms

Note: For **LOA**, **Inv. Mapping**, **L Deg SER Det**, **L Deg SER Rcd**, and **R Deg SER** alarms see Ethernet - PCS on page 362.

➤ **Link Down**

RX: For 10/25/40/100/400G: There is a local or a remote fault condition. For 100/1000 Mbit/s: No bits/clock sync (PMA/PMD Link down), including LOS. For 10 Mbit/s: No data or no Normal Link Pulse (NLP) are received.

➤ **Local Fault Det**¹ (Local Fault Detected)

RX: At least one of the following events is detected: Loss of bit synchronization, Loss of Block synchronization, Link down, or High BER.

➤ **Local Fault Rcd**¹ (Local Fault Received)

RX: The received data path contains the **Local Fault** signal.

➤ **Remote Fault**¹

RX: The received data path contains the **Remote Fault** status.

➤ **Hi-BER** (High-Bit Error Ratio) - (Available with 25/40/100GE interface, and EoOTN 100 GbE client)

RX: The bit error ratio is $> 10^{-4}$ on a fixed time period; 2 ms for 25G, 1250 μ s for 40G, and 500 μ s for 100G.

1. Available with Ethernet 10/25/40/100/400 Gbit/s interface, Ethernet (flex/GFP-F) client, and EoOTN 10/40/100 GbE client. Remote Fault is also available with EoOTN 1GbE client.

Test Results

Alarms/Errors Overview

- **Client Frequency** (available with EoOTN 1GbE client)

RX: The received client signal rate doesn't meet the standard rate specification of 1250000000 ± 150000 bps (± 120 ppm).

Errors

- **Symbol**¹

RX/TX: Invalid code-group is detected/generated in the code.

- **Idle**¹

RX: An error is detected between the end of a frame and the beginning of the next frame.

- **False Carrier**¹

RX: Data is being received with invalid start of frame.

- **Block** (available with Ethernet 10G LAN/WAN interface)

RX: Error block received in frames.

- **Alignment** (available with 10/100 Mbit/s interface)

RX: Frames without an integral number of octets in length are received.

- **FCS** (Frame Check Sequence)

RX: Frames with an invalid FCS are received.

- **Jabber**

RX: Frames larger than 1518 bytes² with an invalid FCS are received; 1534 bytes³ for EoE; 1536 bytes⁴ for PBB-TE.

1. Available with Ethernet 100/1000 Mbit/s interface, and EoOTN 1GbE client.

2. Add 4 bytes to this value for each VLAN layer enabled.

3. Add 4 bytes to this value for each VLAN layer enabled in the encapsulated Ethernet payload and 4 bytes for EoE VLAN when enabled.

4. Add 4 bytes to this value for each VLAN layer enabled in the encapsulated Ethernet payload and 4 bytes for B-VLAN when enabled.

- **Oversize** (available when the **Oversize Monitoring** check box is selected.)
RX: Frames larger than 1518 bytes² with a valid FCS; 1534 bytes³ for EoE; 1536 bytes⁴ for PBB-TE.
- **Runt**
RX: Frames smaller than 64 bytes with an invalid FCS; 80 bytes for EoE; 82 bytes for PBB-TE.
- **Undersize**
RX: Frames smaller than 64 bytes with a valid FCS; 80 bytes for EoE; 82 bytes for PBB-TE.
- **Oversize Monitoring** check box, when selected (cleared by default), allows monitoring the **Oversize** frame errors.

The following errors are only available with **Half Duplex** mode (only for electrical interface at speeds of 10 Mbit/s and 100 Mbit/s).

- **Collision**
RX: Indicates the number of collisions on the link.
- **Late Coll.**
RX: Indicates the number of collisions that have occurred after a 64 bytes transmission.
- **Exc. Coll.**
RX: Indicates the number of frames that were sent 16 times unsuccessfully due to consecutive collisions.

Test Results

Alarms/Errors Overview

Ethernet - PCS

Note: Available with parallel interfaces only: 40/100/400G Gbit/s Ethernet and OTN with 40/100GbE Ethernet client. Available under the **PCS** sub tab for Through Mode test providing alarms/errors for both ports.

Alarms

➤ **LOA** (Loss Of Alignment)

RX: Two or more logical lanes have the same logical lane marker value, or one or more logical lane marker recovery processes are in the OOR state, or if the differential delay between two logical lanes exceeds the configured alarm threshold compensable delay.

➤ **Inv. Mapping** (Invalid Mapping) - (Available with 40/100G)

RX: Indicates errors in the mapping attributed to either a mapping value appearing more than once or a non valid mapping value (out of range).

➤ **Hi-SER** (High-SER) is available with 25G and 400G when **FEC Bypass Indication** check box is selected.

RX: The number of RS-FEC symbol errors exceeds the threshold of 417 in a window of 8192 codewords.

The following alarms are available with 400G when **FEC Degraded SER** is enabled:

➤ **L Deg SER Det** (Local Degraded SER Detected)

RX: Local FEC degraded SER condition is detected.

➤ **L Deg SER Rcd** (Local Degraded SER Received)

RX: Local degraded SER signal is detected.

➤ **R Deg SER** (Remote Degraded SER)

RX: Remote degraded SER signal is detected.

Errors

The following errors are available with 400G:

➤ **66B Block** (Available with 400G)

RX: Invalid 64b/66b block code are received. An invalid 64b/66b block is declared when the synchronization field has a value of 00 or 11.

➤ **FEC-UNCOR-CW** (Available with 400G when RS-FEC is enabled)

RX: FEC uncorrectable codeword error is detected on the Ethernet signal.

➤ **FEC-COR-CW** (Available with 400G when RS-FEC is enabled)

RX: FEC correctable codeword error is detected on the Ethernet signal. The **FEC-COR-CW** does not raise an error, only the count and rate values are reported.

Test Results

Alarms/Errors Overview

Ethernet - PCS Lanes

Note: Available with parallel interfaces only: 40/100/400G Gbit/s Ethernet and OTN with 40/100 GbE Ethernet client. Available under the **PCS** sub tab for Through Mode test providing alarms/errors for both ports.

- **Skew Alarm Threshold (bits)**, available with Ethernet test application, allows setting the threshold value that will be used to declare a skew alarm.

Rate	Range	Default Value
400G	0 to 10550	4781
100G	0 to 2047	928
40G	0 to 4095	1856

- **Default** restore the default skew alarm threshold value.

Alarms

Note: For **LOA** and **Inv. Mapping** alarms see Ethernet - PCS on page 362.

- **LOBL** (Loss of Block Lock)
RX: In lock mode, 65 invalid sync fields (00 or 11) within a 1024 sync window are received. A PCS Lane Lock alarm is cleared when receiving 64 consecutive valid 66b sync field (01 or 10) in a row.
- **LOAML** (Loss of Alignment Marker Lock)
RX: In lock mode, four consecutive marker values are received that do not match the alignment marker that the lane is currently locked to. The LOAML alarm is cleared when the PCS Lane is declared Lock and two valid alignment markers 16384 blocks (66b) apart are received.

➤ **Exc. Skew** (Excessive Skew)

RX: The skew exceeds the defined threshold (see *Skew Alarm Threshold (bits)* on page 145).

Errors

➤ **Block** is available with Ethernet test applications and 100 GbE over OTU4. Injection is not available when RS-FEC is enabled.

RX: Invalid 64b/66b block code are received. An invalid 64b/66b block is declared when the synchronization field has a value of 00 or 11.

➤ **Inv. Marker** (Invalid Marker): Injection is not available when RS-FEC is enabled.

RX: There are errors in the 66-bit block alignment marker.

➤ **PCS BIP-8**

RX: There are PCS lane bit-interleave parity error. A routine even-parity check is performed over all bits of a PCS lane, from and including the previous alignment marker, but not including the current alignment marker.

➤ **PCS BIP-8 Mask** is available with 40GbE over OTU3 test.

RX: At the OTN ingress, the calculated 8-bit error mask contains at least one bit set to “1”.

➤ **OTN BIP-8** is available with 40GbE over OTU3 test

RX: Indicates for each lane that at the OTN egress, the calculated 8-bit error contains at least one bit set to “1”.

➤ **FEC-SYMB** (Available with 400G when **RS-FEC (RX Only)** is enabled)

RX: FEC symbol errors are detected. The **FEC-SYMB** does not raise an error, only the count and rate values are reported.

Fibre Channel

Alarms

➤ **Link Down**

RX: The Fibre Channel connection is down meaning that there is a local or a remote fault condition.

➤ **Local Fault Detected (FC 10X)**

RX: Indicates that at least one of the following events is detected: **LOS**, **Loss of bit synchronization**, **Loss of Block synchronization**, **Link down**, or **High BER** (High BER is true when the bit error ratio $> 10^{-4}$ on a fixed 125 μ s time period).

➤ **Local Fault Received (FC 10X)**

RX: Indicates that the received data path contains the Local Fault signal.

➤ **Remote Fault (FC 10X)**

RX: Indicates that a Remote Fault event is detected.

Error**➤ Symbol (FC 1X/2X/4X/8X)**

RX/TX: Invalid code-group is detected/generated in the code.

➤ Block (FC 10X/16X)

RX: The number of frames received with an errored block condition.

➤ FCS (Frame Check Sequence)

RX: Frames with an invalid FCS are received.

➤ Oversize

RX: The number of received FL-2 frames larger than 2148 bytes with a valid FCS.

➤ Undersize

RX: FL-2 frames smaller than 36 bytes with a valid FCS.

GFP (Generic Framing Procedure)

Note: Available from the GFP-F/GFP-T sub-tab.

Alarms

- **GFP-LFD** (GFP - Loss of Frame Delineation)
RX: Indicates that the GFP engine is out of synchronization.
TX: Generates a sufficient number of cHEC uncorrectable errors to avoid synchronization.
- **GFP-EXM** (GFP - Extension Header Mismatch)
RX: The EXM alarm is declared when the EXI received is different from the expected EXI (refer to EXI on page 181) without uncorrectable cHEC, tHEC, eHEC, and no pFCS errors.
- **GFP-UPM** (GFP - User Payload Mismatch)
RX: The UPM alarm is declared when the UPI received is different from the expected Client Data UPI without uncorrectable cHEC, tHEC, eHEC, and no pFCS errors. The *GFP-F/GFP-T* on page 181 displays the expected UPI value based on the test structure. Refer to page 734 for more information on UPI values.
- **GFP-DCI** (GFP - Defect Clear Indication)
RX: The DCI alarm is declared when CMF frame is received with an UPI set to “0000 0011”.
TX: Generates a client DCI by setting the UPI field to “0000 0011”.

- **GFP-FDI** (GFP - Forward Defect Indication) is available with GFP-F.
RX: The FDI alarm is declared when CMF frame is received with an UPI set to “0000 0100”.
TX: Generates a client FDI by setting the UPI field to “0000 0100”. Note that the configuration of the CMF pFCS check box (see *GFP-F/GFP-T* on page 181) is temporarily cleared and the UPI value changed when the GFP-FDI alarm is selected. The CMF pFCS check box state and the UPI value returns to their previous state/value when another alarm (other than GFP-FDI or GFP-RDI) is selected.
- **GFP-RDI** (GFP - Reverse Defect Indication) is available with GFP-F.
RX: The RDI alarm is declared when CMF frame is received with an UPI set to “0000 0101”.
TX: Generates a client RDI by setting the UPI field to “0000 0101”. Note that the configuration of the CMF pFCS check box (see *GFP-F/GFP-T* on page 181) is temporarily cleared and the UPI value changed when the GFP-RDI alarm is selected. The CMF pFCS check box state and the UPI value returns to their previous state/value when another alarm (other than GFP-FDI or GFP-RDI) is selected.
- **GFP-LOCS** (GFP - CSF-Loss of Client Signal)
RX: LOCS is declared when CMF frame is received while UPI is set to “0000 0001”.
TX: Generates a LOCS by setting the UPI field to “0000 0001”.
- **GFP-LOCCS** (CSF-Loss of Client Character Synchronization)
RX: LOCCS is declared when CMP frame is received with an UPI set to “0000 0010”.
TX: Generates a LOCCS by setting the UPI field to “0000 0010”.

Test Results

Alarms/Errors Overview

- **GFP-Reserved CMF** (Client Management Frame) is available when the **Reserved CMF Monitoring** check box is selected.

RX: CMF alarms other than the ones described above.

Reserved CMF Monitoring check box, when selected, allows monitoring the **GFP-Reserved CMF** alarms.

- **GFP-UserDefined CMF**

TX: Generates a CMF (Client Management Frame) with a user defined UPI.

Errors

- **GFP-cHEC-CORR** (GFP - core Header Error Check - Correctable)

RX: Indicates that only one bit error has been detected on Core header (PLI and cHEC).

TX: Generates a “Walking 1” pattern to hit all applicable bits covered by the cHEC and PLI.

- **GFP-cHEC-UNCORR** (GFP - core Header Error Check - Uncorrectable)

RX: Indicates that two or more bit errors have been detected on Core header (cHEC and PLI).

TX: Generates a “Walking 11” pattern to hit all consecutive 2 bits applicable to the bits covered by the cHEC and PLI.

- **GFP-tHEC-CORR** (GFP - type Header Error Check - Correctable)

RX: Indicates that only one bit error has been detected in the Type header (tHEC, PTI, PFI, EXI, and UPI).

TX (requires client data frame generation): Generates a “Walking 1” pattern to hit all applicable bits covered by the tHEC, PTI, PFI, EXI, and UPI.

- **GFP-tHEC-UNCORR** (GFP - type Header Error Check - Uncorrectable)
RX: Indicates that two or more bit errors have been detected in the Type header (tHEC, PTI, PFI, EXI, and UPI).
TX (requires client data frame generation): Generates a “Walking 11” pattern to hit all consecutive 2 bits applicable to the bits covered by the tHEC, PTI, PFI, EXI and UPI.
- **GFP-eHEC-CORR** (GFP - extension Header Error Check - Correctable) is only available with GFP-F when EXI is set to **Linear**.
RX: Indicates that only one bit error has been detected in the Extension header (eHEC, CID and Spare).
TX (requires client data frame generation): Generates a “Walking 1” pattern to hit all applicable bits covered by the eHEC, CID and Spare.
- **GFP-eHEC-UNCORR** (GFP - extension Header Error Check - Uncorrectable) is only available with GFP-F when EXI is set to **Linear**.
RX: Indicates that two or more bit errors have been detected in the Extension header (eHEC, CID and Spare).
TX (requires client data frame generation): Generates a “Walking 11” pattern to hit all consecutive 2 bits applicable to the bits covered by the eHEC, CID and Spare.
- **GFP-SB-CORR** (GFP - Superblock Correctable) is available with GFP-T.
RX: Indicates that bit error has been detected in the CRC-16 word of the superblock. A received SB Correctable (Pre) error counts as one error while SB Correctable (Post) counts as two errors.
TX:
GFP-SB-CORR (Pre) generates a “Walking 1” pattern to include a single bit error in the CRC-16 word of the superblock.
GFP-SB-CORR (Post) generates in the payload of the superblock, a “Walking 1” pattern to include two separate errors in one superblock separated by 43 bits.

Test Results

Alarms/Errors Overview

- **GFP-SB-UNCORR** (GFP - Superblock Uncorrectable) is available with GFP-T.

RX: Indicates that two or more bit errors have been detected in the CRC-16 word of the superblock. Note that if two errors are spaced by exactly 43 bits, they will not be reported as uncorrectable.

TX: Generates a “Walking 11” pattern to include two consecutive errors in the CRC-16 word of the superblock.

- **GFP-10B_ERR** (GFP - 10B_Error) is available with GFP-T.

RX: Indicates that a 10B_ERR code has been detected in the payload of the superblock.

TX: Generates a 10B_ERR code over the payload of the superblock as defined in ITU G.7041.

- **GFP-pFCS** (GFP - payload Frame Check Sequence)

RX: Indicates that at least one bit error has been detected in the payload.

TX (requires client data frame generation): Generates a “Walking 1” pattern to hit all 32 bits of the pFCS only. Only available with **Ethernet (flex/GFP-F)** client when the **CDF pFCS** check box is selected (refer to *GFP-F/GFP-T* on page 181).

GMP and ODTU4.1 - GMP (Generic Mapping Procedure)

Note: *GMP is only available with EoOTN client (ODU0 with PT21). GMP is displayed under ODUx alarms/errors group. **GMP** is labelled as **ODTU4.1 - GMP** with Multi-Channel OTN.*

Alarms

- **OOS** (Generic Mapping Procedure - Out Of Synchronization).

RX: Indicates that the GMP RX cannot synchronize with the GMP TX.

Errors

- **Cm-CRC-8**

RX: There is a Cm-CRC-8 mismatch between the received value and the locally computed value.

- **CnD-CRC-5**

RX: There is a CnD-CRC-5 mismatch between the received value and the locally computed value.

Interface

Alarms

➤ **LOS** (Loss Of Signal)

RX: Absence of an input signal or an all-zeros pattern is received.
Available for each Optical Lane for parallel interfaces.

For CPRI Framed L2: Absence of an input signal or at least 16 8B/10B code violations occur in one hyperframe.

For Wander 1PPS interface: Either no pulse is received or no pulse is received within 1 second ± 100 ms after the previous pulse.

➤ **LOC Lane** (Loss Of Clock Lane) is available for each Physical Lane for parallel interfaces.

RX: The module is unable to lock on the Physical/CAUI/CAUI-4/XLAUI/400GAUI-16 link interface.

➤ **Frequency** (available for each Physical Lane for parallel interfaces).
Not available when using an active copper SFP.

RX: The received signal frequency meets the standard specifications (green) or not (red).

For Ethernet **10/100/1000M Electrical, 100M Optical, 1GE Optical, 10GE LAN/WAN, 25GE**, or Fibre Channel **1X/2X/4X/8X/10X/16X** interface/rate, the frequency range is ± 100 ppm.

For parallel interfaces:

Rate	Optic Type	Frequency
40GE	4x10G	10.3125 Gbit/s ± 100 ppm
OTU3	4x10G	10.7546 Gbit/s ± 20 ppm
OTU3e1	4x10G	11.1427 Gbit/s ± 20 ppm
OTU3e2	4x10G	11.1458 Gbit/s ± 20 ppm
100GE	4x25G	10.3125 Gbit/s ± 100 ppm
400GE	8x50G	26.5625 Gbit/s ± 100 ppm
OTU4	4x25G	11.181 Gbit/s ± 20 ppm

For serial interfaces:

Interface	Standard Rate Specification
DS1	1544000 ±36.6 ppm
E1	2048000 ±54.6 ppm
E3	34368000 ±24.6 ppm
DS3	44736000 ±24.6 ppm
STS-1e/STM-0e, OC-1/STM-0	51840000 ±20 ppm
E4	139264000 ±19.6 ppm
STS-3e/STM-1e, OC-3/STM-1	155520000 ±20 ppm
OC-12/STM-4	622080000 ±20 ppm
OC-48/STM-16	2488320000 ±20 ppm
OTU1	2666057143 ±20 ppm
OC-192/STM-64	9953280000 ±20 ppm
OTU2	10709225316 ±20 ppm
OTU1e	11049107143 ±100 ppm
OTU2e	11095727848 ±100 ppm
OTU1f	11270089286 ±100 ppm
OTU2f	11317642405 ±100 ppm

Error

- **BPV** (Bipolar Violation) for DS1, DS3, and STS-1e: Pulses of the same consecutive polarity were detected, in violation with the bipolar signal format.
- **CV** (Code Violation)
 - For E1, E3, E4, STM-0e, STM-1e, and STS-3e: Pulses of the same consecutive polarity were detected, in violation with the bipolar signal format.
 - For CPRI/OBSAI: Invalid 10B code word received.
- **K30.7**, for CPRI/OBSAI Framed L2, code word with Error_Propagation /V ordered_set received.

Test Results

Alarms/Errors Overview

➤ **EXZ** (Excessive Zeros)

For **DS1** with **AMI Line Coding**, more than 15 consecutive bit periods with no pulses have been received.

For **DS1** with **B8ZS Line Coding**, more than 7 consecutive bit periods with no pulses have been received.

For **DS3**, more than 2 consecutive bit periods with no pulses have been received.

IP/UDP/TCP

Errors

➤ **IP Chksum** (IP Checksum)

RX: The IP datagrams received have invalid IP header checksum. Only available for IPv4.

➤ **UDP Chksum** (UDP Checksum)

RX: The UDP segments received have invalid UDP checksum.

➤ **TCP Chksum** (TCP Checksum)

RX: The TCP segments received have invalid TCP checksum.

OBSAI

Note: *OBSAI alarms/errors are only available for Framed L2.*

Alarms

➤ **Link Down**

RX: Indicates that the RX state machine is not FRAME_SYNC.

➤ **LOF (Loss Of Frame)**

RX: The RX state machine is in either WAIT_FOR_K28.7_IDLE or SCR_CAP state.

➤ **RP3 Address Mismatch** available when **Address Mismatch** is enabled (refer to page 190)

RX: Indicates that the RP3 Target Address does not match the local RP3 Source Address.

Errors

➤ **FAS (Frame Alignment Signal)**

RX: Error detected in message group terminating character (byte different of K28.5) or master frame terminating character (byte different of K28.7).

➤ **CRC (Cyclic Redundancy Check)**

RX: Indicates a message received with an invalid CRC.

Test Results

Alarms/Errors Overview

ODUx

Note: For OPUx alarms see page 383. For GMP alarms/errors see page 373.

Alarms

➤ **AIS** (Alarm Indication Signal)

RX: The STAT information in the PM byte 3, bits 6 to 8 is “111” for at least 3 consecutive frames.

TX: Generates an all "1"s pattern in the entire ODUk signal, excluding the frame alignment overhead (FA OH), OTUk overhead (OTUk OH) and ODUk FTFL.

➤ **BDI** (Backward Defect indication)

RX: The BDI bit in the PM overhead field (byte 3, bit 5) is “1” for at least 5 consecutive frames.

TX: Generates a “1” in the BDI (byte 3, bit 5) of the PM overhead field continuously.

➤ **BSD** (Backward Signal Degrade)

RX: The FTFL byte 128 is “00000010”.

TX: Generates a “00000010” pattern in the FTFL Byte 128 continuously.

➤ **BSF** (Backward Signal Fail)

RX: The FTFL byte 128 is “00000001”.

TX: Generates a “00000001” pattern in the FTFL Byte 128 continuously.

➤ **FSD** (Forward Signal Degrade)

RX: The FTFL byte 0 is “00000010”

TX: Generates a “00000010” pattern in the FTFL Byte 0 continuously.

- **FSF** (Forward Signal Fail)
RX: The FTFL byte 0 is “00000001”.
TX: Generates a “00000001” pattern in the FTFL Byte 0 continuously.
- **LCK** (Lock)
RX: STAT information in the PM byte 3, bits 6 to 8 is “101” for at least 3 consecutive frames.
TX: Generates a repeating "01010101" pattern in the entire ODUk signal, excluding the frame alignment overhead (FA OH) and OTUk overhead (OTUk OH).
- **LOFLOM** (Loss of Frame Loss Of Multiframe) is only available for mapped ODU client signal (designated as LO in the standard).
RX: OOF is present for at least 3 ms.
TX: Generates error continuously in FAS and MFAS of a multiplexed test case.
- **OCI** (Open Connection Indication)
RX: STAT information in the PM byte 3, bits 6 to 8 is “110” for at least 3 consecutive frames.
TX: Generates a repeating "01100110" pattern in the entire ODUk signal, excluding the frame alignment overhead (FA OH) and OTUk overhead (OTUk OH).
- **TIM** (Trace Identification Mismatch)
RX: The received SAPI and/or DAPI do not math the expected SAPI and/or DAPI. This alarm is only available when the SAPI ODU-TIM and/or DAPI ODU-TIM check boxes are selected from *PT / Global PT* on page 179.

Test Results

Alarms/Errors Overview

Errors

➤ **BIP-8** (Bit Interleave Parity-8)

RX: There is a PM BIP-8 mismatch between the received value and locally computed value (0 to 8).

➤ **BEI** (Backward Error Indication)

RX: Interleaved block in error detected by the corresponding ODU path monitoring sink using the BIP-8 code.

ODU BEI bits (1234)	BIP violations	ODU BEI bits (1234)	BIP violations
0000	0	0101	5
0001	1	0110	6
0010	2	0111	7
0011	3	1000	8
0100	4	1001 to 1111	0

ODUx-TCM

Alarms

- **BDI** (Backward Defect Indication)
 - RX:** The BDI bit in the TCM overhead field Byte 3, bit 5 is “1” for at least 5 consecutive frames.
 - TX:** Generates a "1" in the BDI bit of the TCM overhead field (byte 3, bit 5) continuously.
- **BIAE** (Backward Incoming Alignment Error)
 - RX:** The BEI/BIAE bits in the TCM overhead field Byte 3, bits 1 to 4 are “1011” for at least 3 consecutive frames.
 - TX:** Generates "1011" in the BEI/BIAE bits of the TCM overhead (byte 3, bits 1 to 4) continuously.
- **IAE** (Incoming Alignment Error)
 - RX:** The STAT information in the TCM is “010” for at least 3 consecutive frames.
 - TX:** Generates "1" in the IAE bit of the TCM overhead (byte 3, bit 6) continuously.
- **LTC** (Loss of Tandem Connection)
 - RX:** The STAT information in the TCM Byte 3, bits 6, 7, and 8 are “000” for at least 3 consecutive frames.
 - TX:** Generates "000" in the STAT field of TCM overhead (byte 3, bits 6 to 8) continuously.
- **TIM** (Trace Identification Mismatch)
 - RX:** The SAPI and/or DAPI do not math the expected SAPI and/or DAPI. This alarm is only available when the Enable TIM SAPI and/or DAPI check boxes are selected from *PT / Global PT* on page 179.

Test Results

Alarms/Errors Overview

Errors

➤ **BIP-8** (Bit Interleave Parity-8)

RX: There is a TCM BIP-8 mismatch between the received value and locally computed value (0 to 8).

➤ **BEI** (Backward Error Indication)

RX: Interleaved block in error detected by the corresponding ODU tandem connection monitoring sink using the BIP-8 code.

ODU TCM BEI bits (1234)	BIP violations	ODU BEI bits (1234)	BIP violations
0000	0	0101	5
0001	1	0110	6
0010	2	0111	7
0011	3	1000	8
0100	4	1001 to 1111	0

OPUx

Note: *OPUx is displayed under ODUx alarms/errors group.*

Alarms

- **AIS** (Alarm Indication Signal) is only available on the OPU client signal (designated as LO in the standard).

RX: A PRBS11 pattern is received indicating a failure of the client signal.

TX: Generates a PRBS11 pattern.

- **CSF** (Client Signal Fail) is only available on the OPU client signal (designated as LO in the standard).

RX: Bit 1 of the OPUk PSI[2] byte is set to “1” indicating a failure of the client signal mapped into the OPUk of the OTN signal.

TX: Sets the bit 1 of the OPUk PSI[2] byte to “1”.

- **LOOMFI** (Loss of OPU Multi-Frame Identifier) is only available for OPU4 of a mapped signal.

RX: OOMFI is present for at least 3 ms.

- **MSIM** (Multiplex Structure Identifier Mismatch) is available for the high order path of a multiplexed test case only.

RX: The RX Payload Structure Identifier (PSI) information do not match the expected HO Multiplex Structure Identifier defined.

TX: Corrupts the content of the PSI

For PT20: Bytes 2 and 3 for ODU0 in ODU1, bytes 2 to 5 for ODU1 in ODU2, and bytes 2 to 17 for ODU2 in ODU3. Not applicable for ODU4.
For PT21: Bytes 2 to 9 for ODU1 in ODU2, bytes 2 to 33 for ODU2 in ODU3, and bytes 2 to 81 for ODU3 in ODU4. Not applicable for ODU0.

Test Results

Alarms/Errors Overview

- **OOMFI** (Out of OPU Multi-Frame Identifier) is only available for OPU4 of a mapped signal.

RX: OPU Multi-frame Identifier number are in error for at least 5 consecutive OTU frames.

- **PLM** (Payload Mismatch) is available when OPU-PLM check box is selected.

RX: The Payload Structure Identifier (PSI) field does not match the expected PT for at least 3 consecutive frames.

Errors

- **OMFI** (OPU Multi-Frame Identifier) is only available for OPU4 of a mapped signal.

RX: Invalid OMFI word sequence detected.

OTL

Alarms

- **LOL** (Loss of Lane Alignment)
RX: Multilane alignment process is in the out-of-alignment (OLA) state for 3 ms.
- **LOF** (Loss of Frame)
RX: OOF is present for at least 3 ms.
- **OOF** (Out-Of-Frame)
RX: Any byte of the FAS (bytes 3, 4, and 5) is in error for at least 5 consecutive frames.
- **LOR** (Loss Of Recovery)
RX: When OOR persists at least 3 ms.
- **OOO** (Out-Of-Recovery)
RX: While in In-recovery (IR) state, in five consecutive 16320 byte periods each of the received logical lane marker (LLM) is different from the accepted LLM value.
- **Exc. Skew** (Excessive Skew)
RX: The skew exceeds the defined threshold (see *Skew Alarm Threshold (bits)* on page 549).

Errors

- **FAS** (Frame Alignment Signal)
RX: The FAS bits are in error.
- **Inv. Marker** (Invalid Marker)
RX: Errors are detected in the 66-bit block alignment marker.

Test Results

Alarms/Errors Overview

OTUx

Note: Available for OTU4, OTU3, OTU3e1, OTU3e2, OTU2, OTU2f, OTU1f, OTU2e, OTU1e, and OTU1.

Alarms

- **AIS** (Alarm Indication Signal) available with serial interfaces only.
 - RX:** Polynomial number 11 (PN-11) is over all OTU frame bits including FAS and MFAS for at least 3 consecutive 8192 bit-interval.
 - TX:** Generates polynomial number 11 (PN-11) over all OTU frame bits including FAS and MFAS continuously.
- **BDI** (Backward Defect Indication)
 - RX:** The BDI bit in the SM overhead field (byte 3, bit 5) is “1” for at least 5 consecutive OTU frames.
 - TX:** Generates “1” for the BDI bit in the SM overhead field (byte 3, bit 5) continuously.
- **BIAE** (Backward Incoming Alignment Error)
 - RX:** The BEI/BIAE bits in the SM overhead field (byte 3, bits 1 to 4) are “1011” for at least 3 consecutive frames.
 - TX:** Generates “1011” for the BEI/BIAE bits in the SM overhead field (byte 3, bits 1 to 4) continuously.
- **IAE** (Incoming Alignment Error)
 - RX:** The IAE bit in the SM overhead field (byte 3, bit 6) is “1” for at least 5 consecutive OTU frames.
 - TX:** Generates “1” for the IAE bit in the SM overhead field (byte 3, bit 6) continuously.

- **LOF** (Loss of Frame)
RX: OOF is present for at least 3 ms.
TX: Generates error in all FAS bits continuously.
- **LOM** (Loss Of Multiframe)
RX: OOM is present for at least 3 ms
TX: Generates error in MFAS bits continuously.
- **OOF** (Out-Of-Frame)
RX: FAS (bytes 3, 4, and 5) are in error for at least 5 consecutive OTU frames.
TX: Generates error in all FAS bits for 5 consecutive OTU frames.
- **OOM** (Out-Of-Multiframe)
RX: MFAS are in error for at least 5 consecutive OTU frames.
TX: Generates error in multiframe number for 5 consecutive OTU frames.
- **TIM** (Trace Identifier Mismatch)
RX: Expected SM SAPI and/or SM DAPI do not match the received SM SAPI and/or DAPI for at least 3 consecutive TTI. This alarm is only available when the Enable TIM SAPI OTU-TIM and/or DAPI OTU-TIM check boxes are selected from page 337.

Test Results

Alarms/Errors Overview

Errors

➤ **BEI** (Backward Error Indication)

RX: SM BEI errors are received from the DUT (value 0 to 8).

OTU BEI bits (1234)	BIP violations	ODUk BEI bits (1234)	BIP violations
0000	0	0101	5
0001	1	0110	6
0010	2	0111	7
0011	3	1000	8
0100	4	1001 to 1111	0

➤ **BIP-8** (Bit Interleave Parity-8)

RX: There is a SM BIP-8 mismatch between the received value and locally computed value (0 to 8).

➤ **FAS** (Frame Alignment Signal)

RX: The FAS bits are in error.

➤ **FEC-CORR** (Forward Error Correction - Correctable)

RX: Statistics on codewords (CW; default), symbols (SYMB), or bits (BIT) corrected by the FEC.

TX:

FEC-CORR-CW (Forward Error Correction - Correctable - Codeword): Generates 8 symbols (bytes) containing 8 bits in error each, in each codeword.

FEC-CORR-SYM (Forward Error Correction - Correctable - Symbol): Generates 1 symbol (byte) containing 8 bits in error.

FEC-CORR-BIT (Forward Error Correction - Correctable - Bit): Generates 1 symbol (byte) containing 1bit in error.

➤ **FEC-UNCORR** (FEC - Uncorrectable)

RX: Statistics on the detected codewords (CW) having uncorrectable errors.

TX: FEC-UNCORR-CW (Forward Error Correction - Uncorrectable - Codeword) generates 16 symbol (bytes) containing 8 bits in error each, in each codeword.

➤ **FEC-STRESS** (Forward Error Correction - Stress)

TX: Generates correctable errors composed of a random number of symbol errors (less or equal to 8) containing a random number of bits distributed all over the OTU frame.

➤ **MFAS** (Multiframe Alignment Signal)

RX: The MFAS bits are in error.

Test Results

Alarms/Errors Overview

PTP

Alarms

➤ Loss Sync

RX: The Slave Clock does not receive packet timing signal messages (Sync, Follow Up, Delay Resp) within their expected arrival time for a duration exceeding the configured **Receipt Timeout** (refer to *Alarm Timeout/Threshold* on page 137).

➤ Loss Announce

RX: The Slave Clock does not receive Announce messages within their expected arrival time for a duration exceeding the configured **Receipt Timeout** (refer to *Alarm Timeout/Threshold* on page 137).

➤ Unusable (G.8265.1)

RX: Either the maximum Sync IPDV value or the maximum Delay Req IPDV value in the last second exceeds the configured **IPDV Threshold** (refer to *Alarm Timeout/Threshold* on page 137).

➤ Domain Mismatch (G.8275.1)

RX: None of the received Domain values match the configured value (refer to page 132).

➤ QL Mismatch

RX: The received QL value does not match the Expected QL (refer to page 137 or page 448). The **QL Mismatch** alarm is only reported when at least one Announce message has already been received (**Last QL Received**) and that the **QL Mismatch Monitoring** check box is selected.

QoS Metrics

Note: *Only available with Traffic Gen & Mon test application.*

Errors

➤ **Frame Loss**

RX: A sequence number is missing in the received frames.

➤ **Out-of-Seq.** (Out-of-Sequence)

RX: The received frame sequence number is either smaller than the expected frame sequence number or is a duplicate number.

Reference Signal

Alarms

REF-FAULT

RX: An impairment is detected on the reference signal. When an impairment is detected on the reference signal the test automatically stops.

Test Results

Alarms/Errors Overview

RS-FEC

Alarms

➤ **FEC-LOA** (FEC-Loss Of Alignment)

RX: Deskew process is not complete meaning that not all lanes are synchronized (Alignment Marker locked) and aligned.

➤ **FEC-LOAML** (FEC-Loss Of Alignment Marker Lock)

RX: The location of the alignment marker payload sequence for a given lane on the PMA service interface is not detected.

Error

➤ **Inv-CW-Marker** (Invalid Codeword Marker)

RX: The received Codeword marker is invalid.

➤ **FEC-CORR-CW** (FEC Correctable Codeword)

RX: FEC Codeword that contains errors and were corrected.

➤ **FEC-UNCORR-CW** (FEC Uncorrectable Codeword)

RX: FEC Codeword that contains errors and were not corrected.

➤ **FEC-SYMB** (FEC Symbol)

RX: FEC Symbol that contains errors and were corrected.

S-OAM and MPLS-TP OAM

Alarms

Note: The following alarms are available when the **CC Function** check box is selected (refer to page 271).

➤ **Loss Continuity**

RX: No CCM frames with same or lower MEG/MD Level were received from the peer MEP within an interval equal to 3.5 times the configured CCM transmission period. The alarm is cleared when at least 3 CCM frames with same or lower MEG/MD Level from the peer MEP are received within an interval equal to 3.5 times the configured CCM transmission period.

➤ **Mismerge**

RX: A CCM frame was received from the peer MEP with same MEG/MD Level but with incorrect MEG ID/MAID value or format. The MAID, composed of a Domain ID and a Short MA Name strings, is incorrect if one or both strings are not as expected. The alarm is cleared when no CCM frames with same MEG/MD Level but with incorrect MEG ID/MAID value or format are received within an interval equal to 3.5 times the configured CCM transmission period.

➤ **Unexp MEG/MD Lvl (Unexpected MEG/MD Level)**

RX: A CCM frames was received from the peer MEP with lower MEG/MD Level. The alarm is cleared when no CCM frames with lower MEG/MD Level are received within an interval equal to 3.5 times the configured CCM transmission period.

Test Results

Alarms/Errors Overview

➤ **Unexp MEP** (Unexpected MEP)

RX: A CCM frame was received from the peer MEP with same MEG/MD Level, correct MEG ID/MAID, and correct source MAC Address (corresponds to the peer MEP) but with unexpected MEP ID. The alarm is cleared when no CCM frames with same MEG/MD Level, correct MEG ID/MAID, correct source MAC Address (corresponds to the peer MEP) but with an unexpected MEP ID are received within an interval equal to 3.5 times the configured CCM transmission period.

➤ **Unexp Period** (Unexpected Period)

RX: A CCM frame is received from the peer MEP with same MEG/MD Level, correct MEG ID/MAID, and correct MEP ID but with a period field value different than the one configured. The alarm is cleared when no CCM frames with same MEG/MD Level, correct MEG ID/MAID, and correct MEP ID but with incorrect period field value are received within an interval equal to 3.5 times the configured CCM transmission period.

➤ **RDI** (Remote Defect Indication)

RX: The RDI flag bit of a valid CCM frames is set to 1. A valid CCM frame has its source MAC address matching the Peer MEP MAC address, the destination MAC address matching either the unit port Unicast MAC address or a Multicast class 1 address (refer to page 757), and VLANs matching the unit port VLANs.

TX: The RDI flag bit of transmitted CCM frames is set to 1.

Note: The following alarms are available with G.8113.1, Y.1731 and MEF modes.

➤ **AIS** (Alarm Indication Signal)

RX: A valid AIS frame is received. A valid frame has its destination MAC address matching either the unit port Unicast MAC address or a Multicast class 1 address (refer to page 757), VLANs matching the unit port VLANs, and MEG level matching the local MEG level. The alarm is cleared when during an interval equal to 3.5 times the AIS transmission period indicated in the last received AIS frame, no AIS frames are received.

➤ **LCK** (Locked)

RX: A valid LCK frame is received. A valid frame has its destination MAC address matching either the unit port Unicast MAC address or a Multicast class 1 address (refer to page 757), VLANs matching the unit port VLANs, and MEG level matching the local MEG level. The alarm is cleared when during an interval equal to 3.5 times the LCK transmission period indicated in the last received LCK frame, no LCK frames are received.

➤ **C-LOS** (Client Signal Fail - Loss Of Signal)

RX: A CSF frame is received with CSF type equal to **000**. The alarm is cleared when no CSF (C-LOS) frames are received during an interval equal to 3.5 times the CSF transmission period indicated in the last received CSF (C-LOS) frame, or when a CSF frame is received with Client Defect Clear Indication (C-DCI) information (CSF Type 011).

TX: Generates a CSF frame with CSF type equal to **000**.

Test Results

Alarms/Errors Overview

➤ **C-FDI** (Client Signal Fail - Forward Defect Indication)

RX: A CSF frame is received with CSF type equal to **001**. The alarm is cleared when no CSF (C-FDI) frames are received during an interval equal to 3.5 times the CSF transmission period indicated in the last received CSF (C-FDI) frame, or when a CSF frame is received with Client Defect Clear Indication (C-DCI) information (CSF Type 011).

TX: Generates a CSF frame with CSF type equal to **001**.

➤ **C-RDI** (Client Signal Fail - Remote Defect Indication)

RX: A CSF frame is received with CSF type equal to **010**. The alarm is cleared when no CSF (C-RDI) frames are received during an interval equal to 3.5 times the CSF transmission period indicated in the last received CSF (C-RDI) frame, or when a CSF frame is received with Client Defect Clear Indication (C-DCI) information (CSF Type 011).

TX: Generates a CSF frame with CSF type equal to **010**.

➤ **C-DCI** (Client Signal Fail - Defect Clear Indication)

TX: Generates a CSF frame with CSF type equal to **011**.

Section/Line / RS/MS

Alarms

- **LOF-S** (Loss Of Frame - Section) - SONET
RS-LOF (Regeneration Section - Loss Of Frame) - SDH
RX: A SEF (SONET)/RS-OOF (SDH) defect on the incoming optical signal persists for at least 3 milliseconds.
TX: Generates non-valid framing bytes (A1 and A2).
- **SEF** (Severely Errored Framing) - SONET.
RS-OOF (Regeneration Section - Out-Of-Frame) - SDH.
RX: A minimum of four consecutive errored framing patterns are received.
TX: Generates four consecutive errored framing patterns.
- **TIM-S** (Trace Identifier Mismatch - Section) - SONET
RS-TIM (Regeneration Section - Trace Identifier Mismatch) - SDH
RX: The received J0 Trace doesn't match the expected message value. Only available when Enable TIM-S/RS-TIM check box is selected (refer to *Traces (SONET/SDH)* on page 336).
- **AIS-L** (Alarm Indication Signal - Line) - SONET
MS-AIS (Multiplex Section - Alarm Indication Signal) - SDH
RX: Bits 6, 7 and 8 of the K2 byte contain the "111" pattern in five consecutive frames.
TX: Generates a SONET/SDH signal that contains a valid Section Overhead (SOH) / Regenerator Section Overhead (RSOH) and an all-ones pattern on the SPE.

Test Results

Alarms/Errors Overview

- **RDI-L** (Remote Defect Indication - Line) - SONET
MS-RDI (Multiplex Section - Remote Defect Indication) - SDH
RX: Bits 6, 7, and 8 of the K2 byte contain the “110” pattern in five consecutive frames.
TX: Generates a “110” pattern for the bits 6, 7 and 8 of the K2 byte.

Errors

- **FAS-S** (Frame Alignment Signal - Section) - SONET
RS-FAS (Regeneration Section - Frame Alignment Signal) - SDH
RX: At least one A1 or A2 byte of the FAS word is in error.
- **B1** (BIP-8, Bit-Interleave Parity - 8 bits)
RX: Indicates a Section (SONET) / Regeneration Section (SDH) parity error by performing a routine even-parity check over all frames of the previous STS-n/STM-n signal (located in the first STS-1/STM-1 of an STS-n/STM-n signal).
- **B2** (BIP-8, Bit-Interleave Parity - 8 bits)
RX:
 - SONET: Indicates a Line parity error by performing an even-parity check over all bits of the LOH and SPE of the previous frame (located in every STS-1 of an STS-n signal).
 - SDH: Indicates a Multiplex Section parity error by performing an even-parity check over all bits (except those in the RSOH bytes) of the previous frame of a STM-N signal.
- **REI-L** (Remote Error Indicator - Line) - SONET
MS-REI (Multiplex Section - Remote Error Indicator) - SDH
RX: The M0, M1, or the combination of both M0 and M1 bytes indicate that one or more BIP violations have been detected. Refer to *M0 or M1/Z2 (SONET)* on page 595 for more information. For OC-192, also refer to *REI-L Computation Method* on page 308.

STS-x/AU-x

Alarms

- **AIS-P** (Alarm Indication Signal - Path) - SONET
AU-AIS (Administrative Unit - Alarm Indication Signal) - SDH
RX: The H1 and H2 bytes contain an all-ones pattern in three consecutive frames or more.
TX: Generates an all-ones pattern over H1, H2, H3, and SPE.
- **LOP-P** (Loss Of Pointer - Path) - SONET
AU-LOP (Administrative Unit - Loss Of Pointer) - SDH
RX: A valid pointer is not found in N consecutive frames (where $8 \leq N \leq 10$), or that N consecutive NDFs (“1001” pattern) are detected (non-concatenated payloads).
TX: Generates a non-valid pointer.
- **UNEQ-P** (Unequipped - Path) - SONET
HP-UNEQ (HP - Unequipped) - SDH
RX: The C2 byte contains “00 H” in five consecutive frames. Only available when PLM-P/UNEQ-P / HP-PLM/HP-UNEQ is enabled (refer to *Labels* on page 196).
TX: Generates an all-zeros pattern over POH and SPE.
- **H4-LOM** (H4 - Loss Of Multiframe)
RX: For VT/TU structured optical frames, the system loss track of the H4 byte multiframe indicator sequence.
TX: Generates a wrong H4 byte multiframe indicator sequence.
- **TIM-P** (Trace Identifier Mismatch - Path) - SONET
HP-TIM (HP - Trace Identifier Mismatch) - SDH
RX: J1 Trace doesn't match the expected message value. Only available when TIM-P/HP-TIM is enabled (refer to *Traces (SONET/SDH)* on page 336).

Test Results

Alarms/Errors Overview

- **PLM-P** (Payload Label Mismatch - Path) - SONET
HP-PLM (HP - Payload Label Mismatch) - SDH
RX: Five consecutive frames have mismatched STS/VC signal labels (C2 byte). Only available when PLM-P/UNEQ-P / HP-PLM/HP-UNEQ is enabled (refer to *Labels* on page 196).
- **PDI-P** (Payload Defect Indication - Path) - SONET
RX: For VT-structured STS-1 SPE, there is a LOP-V, AIS-V, DS3 AIS, DS3 LOS, or DS3 OOF defect on any VT or DS3 payload that it embeds into the STS SPE that it is originating. For non-VT-structured STS-1 or STS-Nc SPE, the C2 byte contains the hexadecimal FC code.
TX: For VT-structured STS-1 SPE, generates a VT-structured STS-1 SPE with payload defect. For non-VT-structured STS-1 or STS-Nc SPE, inserts the hexadecimal FC code in the C2 byte.
- **RDI-P** (Remote Defect Indication - Path) - SONET
HP-RDI (High Order Path - Remote Defect Indication) - SDH
RX: Bits 5, 6, and 7 of the G1 byte contain the “100” or “111” pattern in five consecutive frames.
TX: Generates a “100” pattern for bits 5, 6 and 7 of the G1 byte.
- **ERDI-PCD** (Enhanced RDI - Path Connectivity Defect) - SONET
ERDI-CD (Enhanced RDI - Path Connectivity Defect) - SDH
RX: Bits 5, 6 and 7 of the G1 byte contain the “110” pattern in five consecutive frames.
TX: Generates a “110” pattern for bits 5, 6 and 7 of the G1 byte.
- **ERDI-PPD** (Enhanced RDI - Path Payload Defect) - SONET
ERDI-PD (Enhanced RDI - Payload Defect) - SDH
RX: Bits 5, 6 and 7 of the G1 byte contain the “010” pattern in five consecutive frames.
TX: Generates a “010” pattern for bits 5, 6 and 7 of the G1 byte.

- **ERDI-PSD** (Enhanced RDI - Path Server Defect) - SONET
ERDI-SD (Enhanced RDI - Server Defect) - SDH
RX: Bits 5, 6 and 7 of the G1 byte contain the “101” pattern in five consecutive frames.
TX: Generates a “101” pattern for bits 5, 6 and 7 of the G1 byte.

Errors

- **B3** (BIP-8, Bit-Interleave Parity - 8 bits)
RX: Indicates a high order path parity error by performing an even-parity check over all bits of the previous SPE (SONET) / VC-N (SDH).
- **REI-P** (Remote Error Indicator - Path) - SONET
HP-REI (HP - Remote Error Indicator) - SDH
RX: Bits 1 through 4 of the G1 byte contain one pattern from the following binary range: “0001” through “1000” (1 to 8) (located in every STS-1/STM-1 of an STS-n/STM-n signal).

SyncE

Note: *For Wander test application only **ESMC Loss** alarm is supported.*

Alarms

- **ESMC Loss**
RX: No ESMC valid information frames were received for more than 5 seconds.
- **QL Mismatch** (available when the **QL Mismatch Monitoring** check box is selected)
RX: The received QL value does not match the Expected QL (refer to page 323 or page 450).

TCM (SONET/SDH)

Note: TCM is displayed for rates up to OC-192/STM-64 under the STS-x/AU-x or VT/TU alarms/errors group when TCM is enabled.

Alarms

➤ **TC-UNEQ-P / HPTC-UNEQ** (Unequipped)

RX/TX: An all “0”s pattern is received/generated in the higher order path signal label byte (C2), the TCM byte (N1) and the path trace byte (J1), and a valid BIP-8 bytes (B3).

➤ **TC-UNEQ-V / LPTC-UNEQ** (Unequipped)
(LPTC - Unequipped)

RX/TX: An all “0”s pattern is received/generated in the lower order path signal label (bit 5, 6, 7 of byte V5), the TCM byte (Z6/N2) and the path trace byte (J2), and a valid BIP-2 (bits 1, 2 of V5 byte).

➤ **TC-LTC-P / TC-LTC-V / HPTC-LTC / LPTC-LTC** (Loss of Tandem Connection)

RX/TX: A wrong FAS multiframe is received/generated.

➤ **TC-IAIS-P / HPTC-IAIS** (Incoming Alarm Indication Signal)

RX/TX: Bits 1 through 4 of the N1 byte are set to “1110”.

➤ **TC-IAIS-V / LPTC-IAIS** (Incoming Alarm Indication Signal)

RX/TX: Bit 4 of the Z6/N2 byte is set to “1”.

➤ **TC-ODI-P / TC-ODI-V / HPTC-ODI / LPTC-ODI** (Outgoing Defect Indication)

RX/TX:

➤ SONET: Bit 7 of the N1/Z6 byte frame 74 is set to “1”.

➤ SDH: Bit 7 of the N1/N2 byte multiframe 74 is set to “1”.

- **TC-TIM-P / TC-TIM-V / HPTC-TIM / LPTC-TIM** (Trace Identifier Mismatch)

RX: The received message differs from the defined expected message. The TC-TIM is also declared when receiving invalid ASCII characters or when errors are detected with CRC-7.

- **TC-RDI-P / TC-RDI-V / HPTC-RDI / LPTC-RDI** (Remote Defect Indication)

RX/TX:

- **SONET:** The TC-RDI is declared when bit 8 of the N1/Z6 byte frame 73 is set to “1”.
- **SDH:** The TC-RDI is declared when bit 8 of the N1/N2 byte multiframe 73 is set to “1”.

Errors

- **TC-VIOL-P / HPTC-VIOL** (Violations)

RX: TC-VIOL indicates the number of B3 parity violation within the tandem connection for STS-1 SPE/VC-3 and above.

- **TC-VIOL-V / LPTC-VIOL** (Violations)

RX: TC-VIOL indicates the number of violation within the tandem connection for VT6 SPE/VC-2 and below.

Test Results

Alarms/Errors Overview

➤ **TC-IEC-P / HPTC-IEC** (Incoming Error Count)

RX: The TC-IEC indicates the number of B3 parity violations detected at the TC Source for STS-1 SPE/VC-3 and above (bits 1 to 4 of the N1 byte).

Number of BIP-8 violations	Bit				Number of BIP-8 violations	Bit			
	1	2	3	4		1	2	3	4
0	0	0	0	0	8	1	0	0	0
1	0	0	0	1	0	1	0	0	1
2	0	0	1	0	0	1	0	1	0
3	0	0	1	1	0	1	0	1	1
4	0	1	0	0	0	1	1	0	0
5	0	1	0	1	0	1	1	0	1
6	0	1	1	0	0 (IAIS)	1	1	1	0
7	0	1	1	1	0	1	1	1	1

➤ **TC-OEI-P / TC-OEI-V / HPTC-OEI / LPTC-OEI** (Outgoing Error Indication)

RX: Indicates errored blocks of the outgoing VTn/VC-n (bit 6 of the N1 or Z6/N2 byte).

TX: Bit 6 of the N1 or Z6/N2 byte is set to 1.

➤ **TC-REI-P / TC-REI-V / HPTC-REI / LPTC-REI** (Remote Error Indication)

RX: Indicates errored blocks caused within the Tandem Connection (bit 5 of the N1 or Z6/N2 byte).

TX: Bit 5 of N1 or Z6/N2 byte is set to 1.

Transcoding

Note: Only available with OTU3 BERT test application with 40 GbE client.

Alarms

- **LOBL1027B** (Loss of Block Lock 1027 Blocks)
RX: Sixteen 1027-bit blocks with invalid 3-bit patterns are received before sixty-four valid blocks.
- **Hi-BER1027B** (High-Bit Error Ratio 1027 Blocks)
RX: The bit error ratio is $> 10^{-4}$ on a fixed 250 μ s time period.
- **LOAML1027B** (Loss of Alignment Marker Lock 1027 Blocks)
RX: In lock mode, four consecutive marker values are received that do not match the alignment marker that the lane is currently locked to. The LOAML alarm is cleared when the PCS Lane is declared Lock and two valid alignment markers 16384 blocks (66b) apart are received.

Errors

- **Inv. Flag** (Invalid Flag)
RX: A 1027-bit block with invalid 3-bit pattern is received.
- **POSV** (POS Violation)
RX: Two or more POS (Position Field) have the same POS values or they are not in ascending order.
- **SEQV** (Sequence Violation)
RX: Unexpected sequence is detected.
- **MSEQV** (Marker Sequence Violation)
RX: Unexpected marker sequence is detected.

Test Results

Alarms/Errors Overview

VT/TU

Alarms

- **AIS-V** (Alarm Indication Signal - VT) - SONET
TU-AIS (Tributary Unit - Alarm Indication Signal) - SDH
RX: V1 and V2 bytes for the VT/TU path contain an all-ones pattern in three (SONET) / five (SDH) consecutive superframes.
TX: Generates an all-ones pattern for the V1 and V2 bytes of the VT/TU path and payload.
- **LOP-V** (Loss Of Pointer - VT) - SONET
TU-LOP (Tributary Unit - Loss Of Pointer) - SDH
RX: A valid pointer is not found in N consecutive superframes (where $8 \leq N \leq 10$), or if N consecutive NDFs ("1001" pattern).
TX: Generates a non-valid pointer.
- **RDI-V** (Remote Defect Indication - VT) - SONET
LP-RDI (Tributary Unit - Remote Defect Indication) - SDH
RX: Bit 8 of the V5 byte contains "1" in five consecutive VT/TU superframes while bits 6 and 7 of the Z7 (SONET) / K4 (SDH) byte contain the "00" or "11" pattern.
TX: Generates "1" for the bit 8 of the V5 byte and a "00" pattern for bits 6 and 7 of the Z7 (SONET) / K4 (SDH) byte.
- **RFI-V** (Remote Failure Indication - VT) - SONET
LP-RFI (LOP - Remote Failure Indication) - SDH, available with VC-11 only.
RX: Bit 4 of the V5 byte contains "1" in five consecutive superframes.
TX: Generates "1" for the bit 4 of the V5 byte.

- **TIM-V** (Trace Identifier Mismatch - VT) - SONET
LP-TIM (LOP - Trace Identifier Mismatch) - SDH

RX:

- SONET: The J2 Trace doesn't match the expected message value. Only available when the **TIM-V** check box is selected (refer to page *Traces (SONET/SDH)* on page 336).
- SDH: None of the sampled LP trace strings match the expected message value. Only available when the **LP-TIM** check box is selected (refer to page *Traces (SONET/SDH)* on page 336).

- **PLM-V** (Payload Label Mismatch - VT) - SONET
LP-PLM (LOP - Payload Label Mismatch) - SDH

RX: Five consecutive superframes with mismatched VT/LP Signal (bits 5 through 7 of the V5 byte are "000", "001" or "111"). Only available when the **PLM-V/UNEQ-V / LP-PLM/LP-UNEQ** check box is selected (refer to page *Labels* on page 196).

- **UNEQ-V** (Unequipped - VT) - SONET
LP-UNEQ (LOP - Unequipped) - SDH

RX: Bit 5 through 7 of the V5 byte contain "000" for five consecutive superframes. Only available when the **PLM-V/UNEQ-V / LP-PLM/LP-UNEQ** check box is selected (refer to page *Labels* on page 196).

TX: Generates samples of unequipped VT/LP signal label (bits 5 through 7 of V5 byte are set to "000").

- **ERDI-VSD** (Enhanced RDI - VT Server Defect) - SONET
LP-ERDI-SD (LOP - Enhanced RDI - Server Defect) - SDH

RX: Bits 5, 6, and 7 of the Z7 (SONET) / K4 (SDH) byte contain the "101" pattern, and bit 8 of the V5 byte contain "1", in five consecutive VT/LP superframes.

TX: Generates a "101" pattern for bits 5, 6, and 7 of the Z7 (SONET) / K4 (SDH) byte, and "1" for bit 8 of the V5 byte.

Test Results

Alarms/Errors Overview

- **ERDI-VCD** (Enhanced RDI - VT Connectivity Defect) - SONET
LP-ERDI-CD (LOP - Enhanced RDI - Connectivity Defect) - SDH
RX: Bits 5, 6, and 7 of the Z7 (SONET) / K4 (SDH) byte contain the “110” pattern, and bit 8 of the V5 byte contain “1”, in five consecutive VT/LP superframes.
TX: Generates a “110” pattern for bits 5, 6, and 7 of the Z7 (SONET) / K4 (SDH) byte, and “1” for bit 8 of the V5 byte.
- **ERDI-VPD** (Enhanced RDI - VT Path Payload Defect) - SONET
LP-ERDI-PD (LOP - Enhanced RDI - Path Payload Defect) - SDH
RX: Bits 5, 6, and 7 of the Z7 (SONET) / K4 (SDH) byte contain the “010” pattern, and bit 8 of the V5 byte contain “0”, in five consecutive VT/LP superframes.
TX: Generates a “010” pattern for bits 5, 6, and 7 of the Z7 (SONET) / K4 (SDH) byte, and “0” for bit 8 of the V5 byte.

Errors

- **BIP-2** (Bit-Interleave Parity - 2 bits)
RX:
SONET: The BIP-2 error indicates a parity error by performing a routine even-parity check over all VT1.5 bytes of the previous frame of a composite signal (VT1.5/VT2/VT6).
SDH: The BIP-2 error indicates a Low Order Path parity error by performing a routine even-parity check over all bytes of the previous VC frame.
- **REI-V** (Remote Error Indicator - VT) - SONET
LP-REI (Low Order Path - Remote Error Indicator) - SDH
RX: REI is declared when bit 3 of the V5 byte is set to “1”.

WIS

Note: Available under the WIS sub tab for 10G WAN interface only.

Alarms

➤ **WIS Link Down**

RX: At least one of the following errors is present: AIS-P, LOF, PLM-P, SEF, LOP, or AIS-L.

➤ **SEF (Severely Errored Framing)**

RX: A minimum of four consecutive errored framing patterns.

TX: Generates more than four consecutive errored framing patterns.

➤ **LOF (Loss Of Frame)**

RX: A Severely Error Framing (SEF) defect on the incoming SONET signal persists for at least 3 milliseconds.

TX: Generates a non-valid framing pattern.

➤ **AIS-L (Alarm Indication Signal - Line)**

RX: Bits 6, 7 and 8 of the K2 byte contain the "111" pattern in five consecutive frames.

TX: Generates a "111" pattern for the bits 6, 7 and 8 of the K2 byte.

➤ **RDI-L (Remote Defect Indication - Line)**

RX: Bits 6, 7, and 8 of the K2 byte contain the "110" pattern in five consecutive frames.

TX: Generates a "110" pattern for the bits 6, 7 and 8 of the K2 byte.

➤ **AIS-P (Alarm Indication Signal - Path)**

RX: The H1 and H2 bytes for a STS path contain an all-ones pattern in three consecutive frames or more.

TX: Generates an all-ones pattern for H1 and H2 bytes.

Test Results

Alarms/Errors Overview

- **RDI-P** (Remote Defect Indication - Path)

RX: Bits 5, 6 and 7 of the G1 byte contain the “100” or “111” pattern in ten consecutive frames.

TX: Generates a “100” pattern for bits 5, 6 and 7 of the G1 byte.
- **LCD-P** (Loss of Code-Group Delineation - Path)

RX: The signal synchronization has been lost and the valid code-groups are no longer being delineated from the received payload stream being passed to the PCS.

TX: Generates a PCS link down.
- **LOP-P** (Loss Of Pointer - Path)

RX: For non-concatenated payloads, a valid pointer is not found in N consecutive frames (where $8 = N = 10$), or N consecutive NDFs (“1001” pattern) are detected.

TX: Generates a non-valid pointer.
- **PLM-P** (Payload Label Mismatch - Path)

RX: Five consecutive frames have mismatched STS signal labels.
- **UNEQ-P** (Unequipped - Path)

RX: The C2 byte contains “00 H” in five consecutive frames.

TX: Generates samples of unequipped STS signal labels (C2 is set to “00 H”).
- **ERDI-PSD** (Enhanced RDI - Path Server Defect)

RX: Bits 5, 6 and 7 of the G1 byte contain the “101” pattern in five to ten consecutive frames.

TX: Generates a “101” pattern for bits 5, 6 and 7 of the G1 byte.

- **ERDI-PCD** (Enhanced RDI - Path Connectivity Defect)

RX: Bits 5, 6 and 7 of the G1 byte contain the “110” pattern in five to ten consecutive frames.

TX: Generates a “110” pattern for bits 5, 6 and 7 of the G1 byte.
- **ERDI-PPD** (Enhanced RDI - Path Payload Defect)

RX: Bits 5, 6 and 7 of the G1 byte contain the “010” pattern in five to ten consecutive frames.

TX: Generates a “010” pattern for bits 5, 6 and 7 of the G1 byte.

PLM-P/UNEQ-P (Payload Label Mismatch - Path / Unequipped - Path) check box when selected (cleared by default) enables the Signal Label Mismatch for the expected message defined as well as **UNEQ-P** monitoring.

Errors

- **B1** (BIP-8, Bit-Interleave Parity - 8 bits)

RX: Indicates a Section parity error by performing a routine even-parity check over all Section bits of the previous frame of a composite signal (located in the first STS-1 of an STS-n signal).
- **B2** (BIP-1536, Bit-Interleave Parity - 1536 bits)

RX: Indicates a Line parity error by performing a routine even-parity check over all Line bits of the LOH and STS-1 frame capacity of the previous frame of a composite signal (located in every STS-1 of an STS-n signal).
- **B3** (BIP-8, Bit-Interleave Parity - 8 bits)

RX: Indicates a Path parity error by performing a routine even-parity check over all Path bits of the previous SPE excluding the LOH and SOH.

Test Results

Alarms/Errors Overview

➤ **REI-L** (Remote Error Indicator - Line)

RX: Bits 5 through 8 of the M0 byte contain one pattern from the following binary range: "0001" through "1000" (1 to 8) (located in the first STS-1 of an STS-n signal).

➤ **REI-P** (Remote Error Indicator - Path)

RX: Bits 1 through 4 of the G1 byte contain one pattern from the following binary range: "0001" through "1000" (1 to 8) (located in every STS-1 of an STS-n signal).

Inject Button

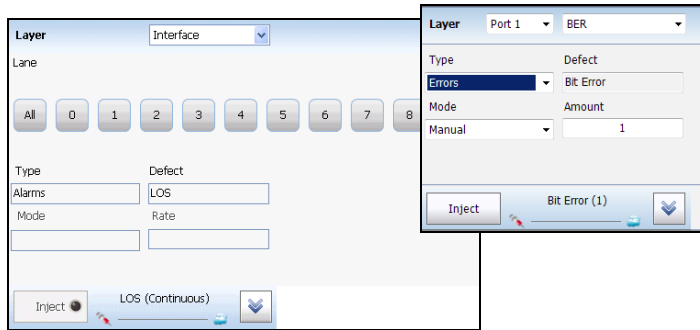

Selected Alarm/Error and status

Open/Close pop-up button

- **Layer:** Allows selecting on which layer is the alarm/error to be generated. Choices depend on the test application and its interface. For Multi-Channel OTN using mix-mapping, **ODUk** and **OPUk** represent ODU and OPU levels of the selected channel(s).
Port 1 or **Port 2** selection, available with **Dual Port** topology, allows selecting the port used for alarm/error injection.
- **Channel,** available with Multi-Channel OTN, allows selecting the channel number that will be used for injection. The **All** button selects all defined channels.
- **Type:** Allows selecting the type of injection, either **Alarms** or **Errors**.
- **Defect:** Allows the selection of the alarm/error defect to be generated. Choices depend on the selected **Layer** and **Type**. Refer to *Alarms/Errors* on page 346 for more information.
- **Mode and Rate/Amount**

Note: Only *Manual* mode is available with **100GE - 4 Unframed CAUI-4** and **OTU4 - 4 Unframed Physical Lanes** on 88220NGE; the amount is fixed to 1; *Pattern Loss* injection is not possible.

Test Results

Alarms/Errors Overview

- **Manual** allows entering the amount of error to be generated: **1** (default) through **50** or **100** (depends on the selected error).
- **Rate** allows the selection of the error injection rate. The rate must be within the minimum and maximum values specified.
- **Max Rate** generates the error to its theoretical maximum rate.
- **Period**, for GFP layer, allows setting the alarm period associated with the client management frames: **10 ms** to **1200 ms** (default is **100 ms**).
- **User-Defined UPI** available with GFP layer, allows entering the Client Management Frame UPI value when **GFP-User-Defined CMF** alarm is selected.

UPI	Description for PTI = 100
0000 0000 and 1111 1111	Reserved
0000 0001	Client Signal Fail (Loss of Client Signal)
0000 0010	Client Signal Fail (Loss of Client Character Synchronization)
0000 0011 through 1111 1110	Reserved for future use

- **Lane**, available with parallel interfaces, allows selecting the physical lane that will be used for injection. Available for Interface, OTL, and PCS layers only.

The following settings are available with Carrier Ethernet OAM test application.

- **Address Type** defines the destination address type of the frame: **Unicast** or **Multicast** (default).
- **Priority**¹ allows selecting the VLAN user priority: **0** (default) to **7**. Refer to *VLAN ID and Priority* on page 758 for more information.
- **Drop Eligible**¹ is set to **No** (no frames will be dropped when congestion occurs) and is not configurable.
- **MEG Level** (Y.1731 and MEF) is the Maintenance Entity Group Level configurable from **0** to **7** (default).
- **Period** determines the transmission period of frames: **1 s** (default) and **1 min**. Not available with C-DCI.
- **Amount**, only available with C-DCI alarm, is set to **1**.

Note: *The RDI alarm is available when the **CC Function** is enabled and is using the parameters from the CC Function (refer to page 271 for more information).*

1. Available when VLAN is enabled (see *VLAN* on page 225).

Test Results

Alarms/Errors Overview

➤ **Inject button**

For **Manual** mode: Manually generates the selected errors according to the defect and the amount selected.

For **Rate** and **Max Rate**: Generates respectively the selected error at the rate specified or at its theoretical maximum rate.

Note: *The selected alarm/error as well as its injection mode and status are displayed next to the **Inject** button.*

- The open/close pop-up button allows respectively expanding (up arrow) or collapsing (down arrow) a pop-up for setting the alarm/error injection parameters.

Analysis - MTIE/TDEV

From the **Test** menu, tap **Results**, **Analysis**, and the **MTIE/TDEV** tab.

Graph

Graphically displays the MTIE/TDEV values in function of the observation interval. The MTIE and TDEV masks are also displayed when supported by the selected standard.

- MTIE values and mask are displayed in pink.
- TDEV values and mask are displayed in blue.

Mask

Allows the selection of an ITU mask used to validate MTIE/TDEV statistics (refer to Mask on page 338).

Remove Offset

Remove Offset check box when selected, subtracts the estimated frequency offset from the Time Error/Time Interval Error data used to calculate the MTIE/TDEV. It is preferable to set this setting before starting the test since changing this setting while the test is running will require some time for MTIE/TDEV recalculation.

MTIE

The **MTIE** check box when selected (default) reports MTIE values on the graph. The MTIE pass/fail verdict is displayed when enabled.

TDEV

The **TDEV** check box when selected (default) reports TDEV values on the graph. The TDEV pass/fail verdict is displayed when enabled.

Test Results

Analysis - MTIE/TDEV

Cursor

The **Cursor** check box when selected (default), allows the selection of a specific observation interval value and returns the MTIE/TDEV values and the corresponding mask when enabled.

- Arrow buttons: Use the left and/or right arrow buttons to move the cursor position on the graph.
- **Obs. Interval (s)** indicates the observation interval value at the cursor position on the graph.
- **MTIE (ns)** indicates the MTIE value and the corresponding mask at the cursor position on the graph.
- **TDEV (ns)** indicates the TDEV value and the corresponding mask at the cursor position on the graph.

Analysis - Time Error / Time Interval Error

From the **Test** menu, tap **Results**, **Analysis**, and the **Time Error** tab.

Graph

Graphically displays the time error values as a function of time.

Note: *A refresh is required to update the graph (see Refresh below).*

Note: *It is possible to zoom/un-zoom on time error (Y axis):*

Using the touch screen, use the pinch-to-zoom to zoom/un-zoom.

Using a mouse, click and drag (highest to lowest value to zoom and lowest to highest value to un-zoom).

Offset

- **Remove Offset** check box when selected, displays a second TE/TIE trace on which the frequency offset has been removed.
- **Freq. Offset (ppm)** indicates an estimated frequency offset of the signal under test since the beginning of the test.

Zoom

Allows zooming to a desired time region (X axis).

- **Time (Start/End)** allows selecting the starting and ending time for the zoom.
- **Refresh** applies the zoom for the selected start and end times.

Refresh

Refreshes the page with the latest collected data.

Test Results

Analysis - Time Error / Time Interval Error

Save TE/TIE Data

Saves the TE/TIE data into CSV file format.

- **Folder Path** allows the selection of the file destination drive and folder. Use the **Browse** button to change the file location. The default file location is:
Users\<<User>\Documents\88000-PowerBlazer\Wander
- **File Name** allows the selection of the file name. The default file name is **Wander** followed by the date and time.
- **Save:** Press **Save** to save the file.
- **Close:** Press **Close** once the save is completed.

FTFL/PT and PT

For OTN BERT and OTN-SONET/SDH BERT: From the **Test** menu tap **Results**, and the **FTFL/PT** tab.

For Multi-Channel OTN: From the **Test** menu, tap **Results**, and the **PT** tab.

Channel

Available with Multi-Channel OTN, allows the selection of the channel number.

ODUx/ODUk Buttons

Tap on an **ODUx/ODUk** button to select the multiplexed level. For Multi-Channel, the ODUk level displayed will be the one corresponding to the selected channel.

FTFL

Indicates the Forward and Backward ODU Fault Type Fault Location. Not available with Multi-Channel OTN.

- **Fault Indication** and **Code** displays the FTFL fault indicator message and its code in hexadecimal format (byte 0 for forward, byte 128 for backward).

Fault Indication	Code
No fault	00 (default)
Signal fail	01
Signal Degrade	02
Reserved	03

Test Results

FTFL/PT and PT

- **Operator Identifier** displays the received operator identifier (bytes 1 to 9 for forward, byte 129 to 137 for backward).
- **Operator Specific** displays the received operator specific (bytes 10 to 127 for forward, byte 138 to 255 for backward).

PT (Payload Type)

➤ Payload Type and Code

Received displays the received payload signal type and its code in hexadecimal format.

Expected allows selecting the expected payload signal type either by selecting the payload from the list or by typing its hexadecimal code.

Note: Refer to PT / Global PT on page 179 for the list.

- **OPU-PLM¹**, when selected, enables the OPU-PLM alarm analysis.
- **Copy RX/Global Copy RX²** uses the received payload type as the expected payload type. For Multi-Channel OTN lower ODU layer, use the arrow button next to the **Copy RX** or **Global Copy RX** to switch from one button to the other; **Global Copy RX** uses the current channel received payload type as the expected payload type for all channels while **Copy RX** only affects the selected channel.

1. For Multi-Channel OTN lower ODU layer, the OPU-PLM check box is only configurable from the test setup.

2. Only available for Multi-Channel OTN lower ODU layer.

GFP-F/GFP-T

Note: This tab is only available with OTN BERT test application with **1GbE**, **10GbE**, or **Ethernet (flex/GFP-F)** client.

From the **Test** menu, tap **Results**, and the **GFP-F/GFP-T** tab.

Transport Layer

- **Bandwidth Usage (%)** indicates the transmitted/received transport layer bandwidth in the last second, excluding the Idle bytes.
- **Mapping Efficiency (%)** indicates the transmitted/received transport layer mapping efficiency (Client Payload Bytes divided by Client Data Bytes multiplied by 100) in the last second.

Frame Type

Note: For **Ethernet (flex/GFP-F)** client with **EXI** set to **Linear**, the **RX** count/rate is configurable to either **RX** (default) or **RX CID Filtered** by tapping on the table **RX** label. **RX CID Filtered** only includes frames that match the expected **CID** (refer to **CID** on page 5).

- **Client Data** indicates the transmitted/received client data frames without uncorrectable cHEC, tHEC, and eHEC errors. Possible rate units are **Frames** (default), **Bytes**, or **Payload Bytes** per second.
- **Client Management** indicates the transmitted/received client management frames without uncorrectable cHEC, tHEC, and eHEC, and pFCS errors. Possible rate units are **Frames** (default), or **Bytes** per second.
- **Idle** indicates the transmitted/received idle frames. Possible rate units are **Frames** (default), or **Bytes** per second.

Test Results

GFP-F/GFP-T

- **Reserved PTI** indicates the received client data and management frames with a payload type identifier different of 000 and 100 without uncorrectable cHEC, tHEC, and eHEC, and pFCS errors. Possible rate units are **Frames** (default), or **Bytes** per second.
- **Reserved PLI** indicates the number of reserved control frames (PLI=1, 2, or 3 while in Synchronization state) received.
- **Invalid** indicates the number of received frames corresponding to at least one of the following conditions:
 - EXI=0000 while PFI=1 and PLI <8
 - EXI=0001 while PFI=0 and PLI <8
 - EXI=0001 while PFI=1 and PLI<12
- **Discarded** indicates the number of received frames with uncorrectable tHEC, eHEC errors, or Invalid Frames.
- **Total** indicates the received frames including Idle, Client Data, Client Management, and frames with a reserved PTI. Possible rate units are **Frames** (default), or **Bytes** per second.

RX Mismatch

- **PFI** (Payload Frame Check Sequence Identifier) indicates the number of frames with PFI field not matching the expected PFI.
- **EXI** (Extension Header Identifier) indicates the number of frames with EXI field not matching the expected EXI.
- **UPI** (User Payload Identifier) indicates the number of frames UPI field not matching the expected UPI.
- **CID** (Channel Identifier), only available when EXI is set to **Linear**, indicates the number of frames CID field not matching the expected CID.

Note: For expected values, refer to GFP-F/GFP-T on page 181 for more information.

Superblock

Note: *Superblock is only available with GFP-T.*

- **Valid** indicates the transmitted/received superblocks without any uncorrectable error.
- **Invalid** indicates the transmitted/received superblocks with uncorrectable error.
- **Total** indicates the total transmitted/received valid and invalid superblocks.

Graph (RFC 2544)

Displays the graph showing the **Throughput**, **Back-to-Back**, **Frame Loss**, and **Latency** measurements. For **Dual Test Set** the graph shows results from **Local to Remote** and **Remote to Local** using distinctive colors. For **Dual Port** topology the graph shows results from P1 to P2 (P1->P2) and P2 to P1 (P2->P1) using distinctive colors.

From the **Test** menu, tap **Results**, and the **Graphs** tab.

- **All** button allows viewing the graphs of all subtests simultaneously.
- **Throughput**, **Back-to-Back**, **Frame Loss**, and **Latency** buttons allow viewing an enlarged graph view of the selected subtest.
- **Displayed Results** allows selecting the displayed results mode, either **Minimum**, **Maximum** (default), **Average**, or **Current**.
- **Step**, available with Frame Loss, allows selecting the result step (100 percent by default) to be displayed.

The X axis shows the frame sizes while the Y axis shows the subtest results.

- **Frame Size (Bytes)** and **Step (%)**, available with Frame Loss, allows selecting either **Frame Size** (default) or **Step** as the X axis criterion.

Labels

From the **Test** menu, tap **Results**, and **Labels**.

Note: *Selecting a Label byte to be generated will automatically update the corresponding OH byte. Refer to OH - SONET/SDH on page 591 for more information.*

Labels

- **STS/AU Path (C2):** The C2 byte is allocated to indicate the content of the STS SPE / VC, including the status of the mapped payloads.

Received: Displays the received C2 byte. Refer to C2 on page 599 for more information.

- **PLM-P/UNEQ-P / HP-PLM/HP-UNEQ:** Enables the Payload Mismatch and STS/AU UNEQ monitoring. This setting is coupled with the configuration of *Labels* on page 196.

Expected: Select the expected C2 byte from the list. Refer to C2 on page 599 for more information.

- **VT/TU Path (V5):** The V5 byte is allocated to indicate the content of the VT/TU path, including the status of the mapped payloads.

Received: Displays the received V5 byte. Refer to V5 on page 602 for more information.

- **PLM-V/UNEQ-V / LP-PLM/LP-UNEQ:** Enables the Payload Mismatch and VT/TU UNEQ monitoring. This setting is coupled with the configuration of *Labels* on page 196.

Expected: Select the expected V5 byte from the list. Refer to V5 on page 602 for more information.

Link OAM

From the **Test** menu, tap **Results**, and the **Link OAM** tab.

Remote MAC Address

Indicates the remote OAM link partner MAC address.

Remote OAM Information

- **OAM Version** indicates the protocol version supported by the DTE.
- **Revision** indicates the revision of the Information TLV.
- **Multiplexer Action** reports the Multiplexer Action:
 - Forward** indicates that the device is forwarding non-OAMPDUs to the lower sublayer.
 - Discard** indicates that the device is discarding non-OAMPDUs.
- **Parser Action** reports the Parser Action:
 - Forward** indicates that the device is forwarding non-OAMPDUs to the higher sublayer.
 - Loopback** indicates that the device is looping back non-OAMPDUs to the lower sublayer.
 - Discard** indicates that the device is discarding non-OAMPDUs.
- **OAM Mode** reports the OAM mode:
 - Active** indicates that the DTE is configured in **Active** mode.
 - Passive** indicates that the DTE is configured in **Passive** mode.
- **OUI** reports the 24-bit IEEE Organizationally Unique Identifier field identifying the vendor.
- **Maximum OAMPDU Size** reports the maximum OAMPDU size in bytes, supported by the DTE.

- **Vendor Specific Information** reports the 32-bit **Vendor Specific Information** field identifying the vendor's product model and version.
- **Unidirectional** reports unidirectional support capability:
 - Supported** indicates that the DTE is capable of sending OAMPDUs when the receive path is non-operational.
 - Unsupported** indicates that the DTE is not capable of sending OAMPDUs when the receive path is non-operational.
- **Remote Loopback** reports OAM remote loopback support capability:
 - Supported** indicates that the DTE is capable of OAM remote loopback mode.
 - Unsupported** indicates that the DTE is not capable of OAM remote loopback mode.
- **Variable Retrieval** reports variable retrieval capability:
 - Supported** indicates that the DTE supports sending Variable Response OAMPDUs.
 - Unsupported** indicates that the DTE does not support sending Variable Response OAMPDUs.
- **Link Events** reports link event capability:
 - Supported** indicates that the DTE supports interpreting Link Events.
 - Unsupported** indicates that the DTE does not support interpreting Link Events.

Remote Error Event Statistics

- **Date Stamp**¹ indicates the date the last Event Notification OAMPDU frame was received.
- **Time Stamp**¹ indicates the time the last Event Notification OAMPDU event was received by the test equipment.
- **Window**

Symbol Period	Errored symbol Window in second
Frame	Errored frame event Window in second
Frame Period	Errored frame period Window - duration period in number of 64 bytes frames
Frame Seconds	Errored frame seconds summary Window

- **Threshold**

Symbol Period	Errored symbol threshold in second
Frame	Errored frame event threshold in second
Frame Period	Errored frame period threshold in second
Frame Seconds	Errored frame seconds summary threshold in second

- **Error Count**

Symbol Period	The number of symbol errors in Window
Frame	The number of frame event errors in Window
Frame Period	The number of frame period errors in Window
Frame Seconds	The number of frame seconds summary errors in Window

1. **Date Stamp** and **Time Stamp** parameters differ from the 802.3 standard definitions.

➤ **Error Running Total**

Symbol Period	The number of symbol errors since the last reset
Frame	The number of frame event errors since the last reset
Frame Period	The number of frame period errors since the last reset
Frame Seconds	The number of frame seconds summary errors since the last reset

➤ **Event Running Total**

Symbol Period	The number of symbol events since the last reset
Frame	The number of frame events since the last reset
Frame Period	The number of frame period events since the last reset
Frame Seconds	The number of frame seconds events since the last reset

Inject Errored Frames

Generates 5 consecutive packets with FCS errors within a 1 second period.

Logger

The Logger page displays color-coded events and pass/fail verdict.

From the **Test** menu, tap **Results**, and the **Logger** tab.

Sort By

Select the sorting order of the event logger entries:

- **ID/Time** (default) displays the event logger entries in numeric ascending order based on the **ID** column of the event logger table.
- **Event** displays the event Logger entries in alphanumeric ascending order based on the **Event** column of the event logger table.

Time Mode

- **Relative** displays the time elapse since the beginning of the test or since the last test reset. The format of the time is Dd HH:MM:SS.
- **Absolute** (default) displays the date and time the event occurred. The time format depends on the platform time settings.

For 24 hours, the time format is MM/DD HH:MM:SS.

For 12 hours, the time format is MM/DD HH:MM:SS <AM or PM>.

Table

The logger table provides the following event logger information.

- **ID**: Indicates the event identification number. The events are sequentially numbered.
- **Time**: Indicates when the event has been detected.
- **Event**: Provides the event type and threshold crossing information.
- **Duration**: Indicates the number of seconds within which the event occurred. Test events like **Test Started** and **Test Stopped** will have no duration.

- **Details:** Provides contextual information including the pass/fail verdict.

The following table displays the nature of information reported by type of event:

Type of Event	Nature of Information
Test Started	Start Date
Test Stopped	Pass/Fail Verdict
Alarm Events	Count value
Error Events	Current Count and Total Count
SDT Events	Service Disruption Time
Threshold Crossing Event	Value at the end of the test

Note: *The Logger table can display up to 5000 event entries. Once the Logger table reports 5000 event entries, a log full indicator appears and no further entries are possible. However, the events in the Pending state will be updated if the test is still running.*

The Event Logger information will be cleared when:

- the test is reset or started.
- stopping the current test and.
- the unit is restarted.

Note: *An entry event remains in the Pending state as long as the event is not completed and it is highlighted on a yellow background color.*

Note: *The Threshold Crossing events are displayed in red text color.*

Test Results

Messages

Messages

From the **Test** menu, tap **Results**, and the **Messages** tab.

Message Type

The count of each OBSAI message type is reported.

Message Type	TX Count	RX Count
Control	-	X
Measurement	-	X
WCDMA/FDD	X	X
WCDMA/TDD	-	X
GSM/EDGE	X	X
TETRA	-	X
CDMA2000	-	X
WLAN	-	X
Loopback	-	X
Frame Clock Burst	X (BTS only)	X (RRH only)
Ethernet	-	X
RTT Message	X	X
802.16	X	X
Virtual HW Reset	-	X
LTE	X	X
Generic Packet	-	X
Multi-hop RTT Message	-	X
Others	-	X

RX Frame Clock Burst Details

When a valid Frame Clock Burst (FCB) message is received, its **SFN** and **c1** values are reported.

- **SFN** (System Frame Number): The master frame number received with an FCB message.
- **c1**: Arrival time of the FCB message Reference Point 1 (RP1) versus master frame start.

MPLS

For **Traffic Gen and Mon**, from the test menu, tap **Results, Streams**, and the **MPLS** tab.

For **Through Mode**, from the test menu, tap **Results, Traffic**, and the **MPLS** tab.

Note: For **Dual Port** topology, the **P1** and **P2** buttons allow respectively displaying results for port #1 (**P1**) or port #2 (**P2**).

Label 1 and Label 2

The number of MPLS frames transmitted (TX) and received (RX) are displayed for both **Label 1** and **Label 2** for each **Stream**. Not available for **Through Mode** test application.

Total TX/RX MPLS

- **Line Utilization** indicates the percentage of MPLS line rate utilization in TX and RX.
- **Ethernet BW (%)** (Ethernet Bandwidth) indicates the MPLS data rate in TX and RX.
- **Frame Rate (frames/s)** indicates the number of transmitted (TX) and received (RX) MPLS frames).
- **Frame Count** indicates the count of transmitted (TX) and received (RX) MPLS EtherType (0x8847 or 0x8848) frames regardless if FCS is good or not.

OTL-SDT

Note: Only available for parallel interfaces when an OTL defect, at the exception of LOL, is selected for Service Disruption Time (refer to Service Disruption on page 142).

From the **Test** menu, tap **Results**, and the **OTL-SDT** tab.

Service Disruption

Note: Service Disruption results are only available when **Disruption Monitoring** is enabled (refer to BERT and Unframed BERT on page 139).

Service Disruption is the time during which there is a disruption of service due to the absence of traffic or to the detection of defects per lane.

Disruption Time

- **Defect** indicates on which layer and defect the service disruption time test is performed.
- **Lane** indicates the lane number.
- **Longest (ms)** indicates the longest measured disruption time per lane.
- **Shortest (ms)** indicates the shortest measured disruption time per lane.
- **Last (ms)** indicates the length of the last measured disruption time per lane.
- **Average (ms)** indicates the average duration of all measured disruption times per lane.
- **Total (ms)** indicates the total duration of all measured disruption times per lane.
- **Count** indicates the number of disruption events detected since the beginning of the SDT test per lane.

Test Results

OTL-SDT

- **Longest Disruption** indicates the longest measured disruption time.
- **Lanes with Disruption** indicates the number of lanes with service disruption.

Note: *When a disruption event is equal or longer than the test period which is fixed to 5 minutes, then the measured disruption time is equal to the test period.*

Performance Monitoring

Note: *This tab is only available with Transport test applications with Pattern client.*

The Performance Monitoring tab gives error performance events and parameters for the circuit under test.

From the **Test** menu, tap **Results**, and the **Performance Monitoring** tab.

Each button on top of the window represents a level of the analyzed signal for which the Performance Monitoring (PM) is available. Each button also displays the PM standard(s) available for this level. Tap a signal level button to get its PM results.

Analyzed Signal	Standard's availability						
	G.821	G.826 ISM	G.828 ISM	G.829 ISM	M.2100 ISM	M.2100 OOSM	M.2101 ISM
DS3/DS1/E4/E3/E2/E1		X			X		
Section/RS				X			
Line/MS				X			X
VTn/STS-n/AU-n/ TU-n			X				X
BERT	X					X	

Note: *G.821 and M.2100 OOSM are only available when **No Pattern Analysis (Live)** check box is cleared (refer to page 139).*

Test Results

Performance Monitoring

Near-End

- **EFS** (Error Free Second) (**G.821**, **G.826**, **G.828**, and **G.829**): Gives the number of seconds within which no error occurred.
- **EC** (Error Count) (**G.821** only): Gives the number of bit errors.
- **EB** (Errored Block) (**G.826**, **G.828**, and **G.829**): Gives the count of blocks in which one or more bits are in error.
- **ES** (Errored Second)

For **G.821**, and **M.2100 OOSM**: Gives the number of seconds within which one or more bit error occurred, or during which Loss Of Signal (LOS) or AIS is detected.

For **G.826**, **G.828**, **G.829**, **M.2100 ISM**, and **M.2101**: Gives the number of seconds within which one or more anomalies (FAS (DSn/PDH), EB, etc.) occurred, or at least one defect occurred.

- **SES** (Severely Errored Second)

For **G.821**, and **M.2100 OOSM**: Gives the number of seconds within which a bit error ratio is $\geq 10^{-3}$, or during which one defect (LOS/AIS) is detected.

For **G.826**, **G.828**, **G.829** and **M.2101**: Gives the number of seconds within which anomalies (FAS (DSn/PDH), EB, etc.) are $\geq X$ percent (see table below) or at least one defect occurred. X=30 percent for DSn/PDH signals; see the following table for SONET/SDH signals SES threshold.

	OC-1 STS-1e STM-0 STM-0e	OC-3 STS-3e STM-1 STM-1e	OC-12 STM-4	OC-48 STM-16	OC-192 STM-64	OC-768 STM-256
Path	30 %	30 %	30 %	30 %	30 %	30 %
Line/MS	15 %	15 %	25 %	30 %	30 %	30 %
Section/RS	10 %	30 %	30 %	30 %	30 %	30 %

For **M.2100 ISM**: Gives the count of the seconds within which anomalies (frame bit errors, CRC block errors, etc.) are $\geq Y$ or at least one defect occurred. Y depends on the type of DS_n/PDH signal as described in the following table.

Signal	SES Threshold
DS1 (SF)	8 frame bit errors (Near-End)
DS1 (ESF)	320 CRC-6 block errors (Near-End) 320 CRC-6 block errors (Far-End, if FDL enabled)
E1 (Framed without CRC-4)	28 frame bit errors (Near-End)
E1 (Framed with CRC-4)	805 CRC-4 block errors (Near-End) 805 E-bit errors (Far-End)
DS3 (M13)	2444 P-bit errors (Near-End) or 5 F-bit errors (Near-End)
DS3 (C-bit Parity)	2444 P-bit errors (Near-End) or 5 F-bit errors (Near-End) 2444 FEBE errors (Far-End)
E2 (Framed)	41 frame bit errors (Near-End)
E3 (Framed)	52 frame bit errors (Near-End)
E4 (Framed)	69 frame bit errors (Near-End)

- **BBE (Background Block Error) (G.826, G.828, G.829, and M.2101)**: Gives the count of Errored Block not occurring as part of a SES.

Test Results

Performance Monitoring

- **UAS (Unavailable Second):** Gives the count of the seconds corresponding to the periods of unavailable time that begins at the onset of 10 consecutive SES events, including these 10 seconds. A period of available time shall begin at the onset of 10 consecutive non-SES events, including these 10 seconds.

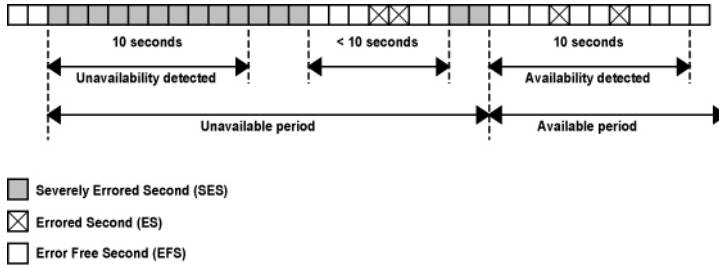

- **ESR (Errored Second Ratio) (G.821, G.826, G.828, and G.829):** Gives the ratio of the number of ES in available time (AS) during a fixed measurement interval.

$$\text{ESR} = \text{ES} \div \text{AS}$$

- **SESR (Severely Errored Second Ratio) (G.821, G.826, G.828, and G.829):** Gives the ratio of the number of SES in available time (AS) during a fixed measurement interval.

$$\text{SESR} = \text{SES} \div \text{AS}$$

- **BBER (Background Block Error Ratio) (G.826, G.828, G.829, and M.2101):** Gives the ratio of BBE in available time (AS) to total blocks in available time during a fixed measurement interval. The count of total blocks excludes all blocks during SESs.
- **DM (Degraded Minutes) (G.821 only):** A Degraded Minute is the number of minutes in which the estimated error rate exceeds 10^{-6} but does not exceed 10^{-3} . DM is determined by collecting all of the Available Seconds, removing any SES grouping the result in 60-second long groups and counting a 60-second long group as degraded if the cumulative errors during the seconds present in the group exceed 10^{-6} .

- **SEP** (Severely Errored Period) (**G.828** only): A sequence between 3 to 9 consecutive SES. The sequence is terminated by a second which is not a SES.
- **SEPI** (Severely Errored Period Intensity) (**G.828** only): Gives the count of SEP events in available time, divided by the total available time in seconds.

Far-End

- **EFS** (Error Free Second): Gives the count of the seconds within which no error occurred or when a defect is detected on the near-end.
- **EC** (Error Count) (**G.821** only): Gives the number of bit errors.
- **EB** (Errored Block) (**G.826**, **G.828**, and **G.829**): Gives the count of blocks in which one or more bits are in error.
- **ES** (Errored Second): For **G.826**, **G.828**, **G.829**, **M.2100 ISM**, and **M.2101**: Gives the count of the seconds within which one or more anomalies (FAS (DSn/PDH), EB, etc.) occurred or at least one defect occurred.
- **SES** (Severely Errored Second)

For G.826, G.828, G.829 and M.2101: Gives the number of seconds within which anomalies (FAS (DSn/PDH), EB, etc.) are $\geq X$ percent (see table below) or at least one defect occurred. $X=30$ percent for DSn/PDH signals; see the following table for SONET/SDH signals SES threshold.

	OC-1 STS-1e STM-0 STM-0e	OC-3 STS-3e STM-1 STM-1e	OC-12 STM-4	OC-48 STM-16	OC-192 STM-64	OC-768 STM-256
Path	30 %	30 %	30 %	30 %	30 %	30 %
Line/MS	15 %	15 %	25 %	30 %	30 %	30 %
Section/RS	10 %	30 %	30 %	30 %	30 %	30 %

Test Results

Performance Monitoring

For M.2100 ISM: Gives the count of the seconds within which anomalies (frame bit errors, CRC block errors, etc.) are $\geq Y$ or at least one defect occurred. Y depends on the type of DSn/PDH signal as described in the following table.

Signal	SES Threshold
DS1 (SF)	8 frame bit errors (Near-End)
DS1 (ESF)	320 CRC-6 block errors (Near-End) 320 CRC-6 block errors (Far-End, if FDL enabled)
E1 (Framed without CRC-4)	28 frame bit errors (Near-End)
E1 (Framed with CRC-4)	805 CRC-4 block errors (Near-End) 805 E-bit errors (Far-End)
DS3 (M13)	2444 P-bit errors (Near-End) or 5 F-bit errors (Near-End)
DS3 (C-bit Parity)	2444 P-bit errors (Near-End) or 5 F-bit errors (Near-End) 2444 FEBE errors (Far-End)
E2 (Framed)	41 frame bit errors (Near-End)
E3 (Framed)	52 frame bit errors (Near-End)
E4 (Framed)	69 frame bit errors (Near-End)

- **BBE** (Background Block Error) (G.828 and G.829 Line): Gives the count of Errored Blocks not occurring as part of an SES.

- **UAS (Unavailable Second):** Gives the count of the seconds corresponding to the period of unavailable time that begins at the onset of 10 consecutive SES events, including these 10 seconds. A period of available time shall begin at the onset of 10 consecutive non-SES events, including these 10 seconds.

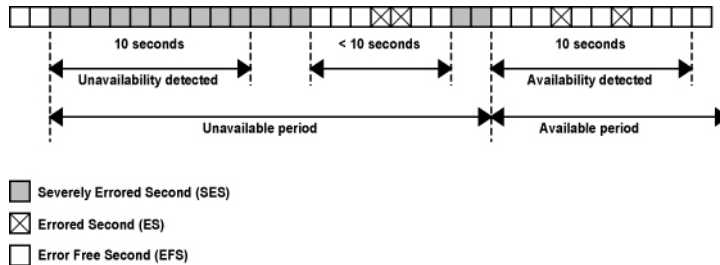

- **ESR (Errored Second Ratio):** Gives the ratio of the number of ES in available time to total seconds in available time during a fixed measurement interval.

$$ESR = ES \div AS$$

- **SESR (Severely Errored Second Ratio):** Gives the ratio of the number of SES in available time to total seconds in available time during a fixed measurement interval.

$$SESR = SES \div AS$$

- **BBER (Background Block Error Ratio):** Gives the ratio of BBE in available time to total blocks in available time during a fixed measurement interval. The count of total blocks excludes all blocks during SESs.

Test Results

PTP Stats

PTP Stats

From the **Test** menu, tap **Results**, and the **PTP Stats** tab.

TX/RX PTP Message Count/Rate

Gives the transmitted/received count and average rate for each PTP message, and the total count for all messages.

TX	RX
Signaling Announce Req ^a	Signaling Announce Grant ^a
Signaling Sync Req ^a	Signaling Sync Grant ^a
Signaling Delay Resp Req ^a	Signaling Delay Resp Grant ^a
Delay Req	Delay Resp
	Sync
	Follow Up
	Announce

- a. The rate value corresponds to an average rate because these messages are only transmitted/received when negotiating or renewing the lease with the Grand Master clock. If the connection with the Grand Master Clock was already established when the test is started, the 0 value is displayed. However, the value becomes available with the next lease renewal which happens every 150 seconds. Only available with G.8265.1 profile.

Note: *In the case where messages are lost while the Receipt Timeout is set to a large value (slow communication), the last valid recorded rate value will be preceded with < to indicate that the reception rate is not stable. This applies to **Delay Resp**, **Announce**, **Sync**, and **Follow UP**.*

Note: *When the rate is above 150 messages/s, > 150 is displayed.*

IPDV

Inter Packet Delay Variation (IPDV) is available for **Sync** and **Delay Req** messages and is measured for all valid in-sequence messages (see *Delay Measurement* on page 478). **Current**, **Average**, **Minimum**, **Maximum**, and **Standard Deviation** measurement values are displayed. The **Standard Deviation** is the measure of the dispersion of messages from its mean. When a value is below 1μ second, **< 1 μ s** is displayed. The pass/fail verdict is also displayed beside the maximum value when enabled.

Test Results

Quality Level (1588 PTP)

Quality Level (1588 PTP)

The quality level characterizes the clock quality in terms of network synchronization.

From the **Test** menu, tap **Results**, and the **Quality Level** tab.

- **Last QL Received** indicates the last Quality Level value received. The pass/fail verdict is also displayed when both **QL Mismatch Monitoring** and **Pass/Fail Verdict** check boxes are selected.
- **Last Change** indicates the date and time of the Last QL has changed.
- **QL Mismatch Monitoring** when selected (default) enables the Quality Level mismatch monitoring.
- **Expected QL** allows the selection of the Expected Quality Level value. Available when the **QL Mismatch Monitoring** check box is selected.

Profile ITU	Quality Level value	PTP Clock Class	Description
G.8275.1	QL-PRC/PRS	6, 7, 135, 140	Primary Reference Clock Traceable (G.811)
	QL-SSU-A/ST2	150	Type I or V slave clock (G.812) Traceable to Stratum 2 (G.812 Type II)
	QL-SSU-B/ST3E (default)	160	Type VI slave clock (G.812) Traceable to Stratum 3E (G.812 Type III)

Profile ITU	Quality Level value	PTP Clock Class	Description
G.8265.1	QL-PRS (default)	80	Primary Reference Source Traceable (G.811)
	QL-STU/UNK	82	Synchronized - Traceability Unknown
	QL-PRC	84	Primary Reference Clock Traceable (G.811)
	QL-ST2	86	Traceable to Stratum 2 (G.812 Type II)
	QL-INV3	88	Quality Level Invalid 3
	QL-SSU-A/TNC	90	Type I or V slave clock (G.812) Traceable to Transit Node Clock (G.812 Type V)
	QL-INV5	92	Quality Level Invalid 5
	QL-INV6	94	Quality Level Invalid 6
	QL-SSU-B	96	Type VI slave clock (G.812)
	QL-INV9	98	Quality Level Invalid 9
	QL-ST3E	100	Traceable to Stratum 3E (G.812 Type III)
	QL-EEC2/ST3	102	Ethernet Equipment Clock Option 2 Traceable to Stratum 3 (G.812 Type IV)
	QL-EEC1/SEC	104	Ethernet Equipment Clock Option 1 Synchronous Equipment Clock (G.813 or G.8262, Option 1)
	QL-SMC	106	Traceable to SONET Minimum Clock (G.813 or G.8262, Option 2)
	QL-PROV	108	Provisionable by the Network Operator (PNO)
QL-DNU/DUS	110	Do Not Use Do Not Use for Synchronization	

- **Count** gives the count for each QL code (PTP Clock Class) included in the announce message received.
- **Other** includes all clock class codes (0 to 255) included in the announce message received other than the QL codes (see table above). Refer to page 477 for the complete list.
- **Total** indicates the total count of all QL code messages received.

Test Results

Quality Level (SyncE)

Quality Level (SyncE)

The quality level characterizes the clock quality in terms of network synchronization.

From the **Test** menu, tap **Results**, and the **Quality Level** tab.

- **Generated QL** indicates the Quality Level value that is generated.
 - Last Change** indicates the date and time of the Generated Quality Level value has changed. For 1GE Electrical interface using **Local Clock** set to **Slave**, the **Last Change** is not available.
- **Last QL Received** indicates the last Quality Level value received. The pass/fail verdict is also displayed when both **QL Mismatch Monitoring** and **Pass/Fail Verdict** check boxes are selected.
 - Last Change** indicates the date and time of the Last QL Received has changed.
- **QL Mismatch Monitoring** when selected (default), enables the Quality Level mismatch monitoring.
- **Expected QL** allows the selection of the Expected Quality Level value. Available when the **QL Mismatch Monitoring** check box is selected.

Quality Level value	SSM	Description
QL-STU/UNK	0	Synchronized - Traceability Unknown
QL-PRS	1	Primary Reference Source Traceable (G.811)
QL-PRC	2	Primary Reference Clock Traceable (G.811)
QL-INV3	3	Quality Level Invalid 3
QL-SSU-A/TNC	4	Type I or V slave clock (G.812) Traceable to Transit Node Clock (G.812 Type V)
QL-INV5	5	Quality Level Invalid 5
QL-INV6	6	Quality Level Invalid 6
QL-ST2	7	Traceable to Stratum 2 (G.812 Type II)

Quality Level value	SSM	Description
QL-SSU-B	8	Type VI slave clock (G.812)
QL-INV9	9	Quality Level Invalid 9
QL-EEC2/ST3 (default)	10	Ethernet Equipment Clock Option 2 Traceable to Stratum 3 (G.812 Type IV)
QL-EEC1/SEC	11	Ethernet Equipment Clock Option 1 Synchronous Equipment Clock (G.813 or G.8262, Option 1)
QL-SMC	12	Traceable to SONET Minimum Clock (G.813 or G.8262, Option 2)
QL-ST3E	13	Traceable to Stratum 3E (G.812 Type III)
QL-PROV	14	Provisionable by the Network Operator (PNO)
QL-DNU/DUS	15	Do Not Use Do Not Use for Synchronization

- **QL Mismatch Frame Count** gives the total count of information and/or event frames received not matching the expected Quality Level. Only available when the **QL Mismatch Monitoring** check box is selected.
- **TX**
 - **Information** gives the count of information frames generated for each Quality Level as well as the total of all Quality Level values. For 1GE Electrical interface using **Slave** as **Master-Slave Clock**, only the count for **QL-DNU/DUS** is reported.
 - **Event** gives the count of event frames generated for each Quality Level as well as the total of all Quality Level values. Not available with 1GE Electrical using **Slave** as **Master-Slave Clock**.
- **RX**
 - **Information** gives the count of information frames received for each Quality Level as well as the total of all Quality Level values.
 - **Event** gives the count of event frames received for each Quality Level as well as the total of all Quality Level values.

S-OAM and MPLS-TP OAM

From the **Test** menu, tap **Results**, and the **S-OAM** or **MPLS-TP OAM** tab.

Loopback

- **Status** displays the status of the test function (refer to page 511).
- **TX LBM** indicates the count of transmitted LBM frames.
- **RX LBR** indicates the count of valid LBR frames received. A valid frame for S-OAM has its source MAC address matching the Peer MEP MAC address, destination MAC address matching the unit port MAC address, and VLANs matching the unit port VLANs. A valid frame for MPLS-TP OAM has its destination MAC address matching either the unit MAC address, FF:FF:FF:FF:FF:FF, or 01:00:5E:90:00:00; VLANs matching the unit port VLANs; and MPLS Labels matching the local MPLS Label Stack configuration.

- **LBR Timeout**

For connectivity verification (Continuous check box cleared), indicates the count of LBR Timeout event which occurs if a reply (LBR frame with matching Transaction ID) to a transmitted LBM frame is not received within 5 seconds.

For diagnostic test (Continuous check box selected), indicates the difference between the transmitted LBM frames and the received LBR frames.

- **Invalid LBR**

For connectivity verification (Continuous check box cleared), indicates the count of LBR frames received from the peer MEP with incorrect MEG/MD Level or with an unexpected Transaction ID.

For diagnostic test (Continuous check box is selected), indicates the count of LBR frames received from the peer MEP with incorrect MEG/MD Level.

- **Invalid Payload** indicates the count of received LBR frames having either a TLV type different than the one transmitted, Bit error or wrong data value detected in the data payload of a Data TLV, Bit error, Pattern Loss, or Pattern Type mismatch of a Test TLV.
- **Successful** indicates the count of received LBR frames having no errors.
- **Failed** indicates the count of LBR frames declared as invalid.

Test

- **Status** displays the status of the test function (refer to page 511).
- **TX TST** indicates the count of transmitted TST frames.
- **RX TST** indicates the count of valid TST frames received. A valid frame for S-OAM has its source MAC address matching the Peer MEP MAC address; destination MAC address matching either the unit port Unicast MAC address or a Multicast class 1 address¹; and VLANs matching the unit port VLANs. A valid frame for MPLS-TP OAM has its destination MAC address matching either the unit MAC address, FF:FF:FF:FF:FF:FF, or 01:00:5E:90:00:00; VLANs matching the unit port VLANs; and MPLS Labels matching the local MPLS Label Stack configuration.
- **Invalid TST** indicates the count of TST frames received from the peer MEP with incorrect MEG/MD level.
- **Invalid Payload** indicates the count of received TST frames having either an unsupported pattern type, or bit error / pattern loss detected in the payload.
- **Successful** indicates the count of received TST frames having no errors.
- **Failed** indicates the count of TST frames declared as invalid.

1. Refer to *Unicast/Multicast Addresses for Ethernet OAM* on page 757 for more information.

Test Results

S-OAM and MPLS-TP OAM

Frame Delay

- **Status** displays the status of the test function (refer to page 511).
- **TX DMM** indicates the count of transmitted DMM frames.
- **RX DMR** indicates the count of valid DMR frames received. A valid frame for S-OAM has its source MAC address matching the Peer MEP MAC address; destination MAC address matching the unit port MAC address; and VLANs matching the unit port VLANs. A valid frame for MPLS-TP OAM has its destination MAC address matching either the unit MAC address, FF:FF:FF:FF:FF:FF, or 01:00:5E:90:00:00; VLANs matching the unit port VLANs; and MPLS Labels matching the local MPLS Label Stack configuration..
- **Invalid DMR** indicates the count of received DMR frames from the peer MEP having an incorrect MEG/MD Level, an incorrect Test ID (when applicable), or with a valid MEG/MD Level and valid Test ID (when applicable) but with a Frame Delay outside the 0.001 to 8000.000 ms range.
- **Delay (ms): Current** indicates the average of frame delay measured in the last second. **Minimum, Maximum, and Average** indicates respectively the minimum, maximum, and average frame delays measured since the beginning of the test.
- **Successful** indicates the count of received DMR frames having no errors.
- **Failed** indicates the count of DMR frames declared as invalid.

Frame Loss

- **Status** displays the status of the test function (refer to page 511).
- **TX LMM** indicates the count of transmitted LMM frames.
- **RX LMR** indicates the count of valid LMR frames received. A valid frame for S-OAM has its source MAC address matching the Peer MEP MAC address; destination MAC address matching the unit port MAC address; and VLANs matching the unit port VLANs. A valid frame for MPLS-TP OAM has its destination MAC address matching either the unit MAC address, FF:FF:FF:FF:FF:FF, or 01:00:5E:90:00:00; VLANs matching the unit port VLANs; and MPLS Labels matching the local MPLS Label Stack configuration.
- **Invalid LMR** indicates the count of LMR frames received from the peer MEP with incorrect MEG/MD level.
- **Frame Loss** is calculated (count and %) for both Near-End and Far-End over all valid LMR frames received.
- **Successful** indicates the count of received LMR frames having no errors.
- **Failed** indicates the count of LMR frames declared as invalid.

Test Results

S-OAM and MPLS-TP OAM

Synthetic Loss

Note: *Only available with Ethernet OAM.*

- **Status** displays the status of the test function (refer to page 511).
- **TX SLM** indicates the count of transmitted SLM frames.
- **RX SLR** indicates the count of valid SLR frames received. A valid frame has its source MAC address matching the Peer MEP MAC address; destination MAC address matching the unit port MAC address; and VLANs matching the unit port VLANs.
- **Invalid SLR** indicates the count of SLR frames received from the peer MEP with incorrect MEG/MD level, incorrect source MEP ID, or incorrect Test ID.
- **Synthetic Loss** is calculated (count and %) for both Near-End and Far-End over all frames received and is updated after each Synthetic Loss measurement period (after receiving the defined **Frame Count**, refer to page 276).
- **Successful** indicates the count of received SLR frames having no errors.
- **Failed** indicates the count of SLR frames declared as invalid.

SDT (Multi-Channel OTN)

From the **Test** menu, tap **Results** and the **SDT** tab.

Note: *The SDT tab is only available when **Disruption Monitoring** is enabled (refer to ODU Channels - Global on page 237).*

Service Disruption is the time during which there is a disruption of service due to the absence of traffic or to the detection of defects per channel.

- **Channels with Disruption** indicates the number of channels with service disruption.
- **Channels Monitored** indicates the number of channels monitored.
- **Channels Above Threshold**, available when pass/fail verdict is enabled, indicates the number of channels with a disruption time above the defined threshold.
- **Longest Disruption** indicates the duration of the longest measured disruption time and the channel number on which it occurred. The Pass/Fail verdict when enabled, is displayed next to duration value.
- **Last Disruption** indicates the duration of the last measured disruption time and the channel number on which it occurred.
- **SDT Threshold (ms)**, available when pass/fail verdict is enabled, allows entering the SDT threshold value that will be used to declare the pass/fail verdict: **0.001** to **299999.999 ms** (default is **50 ms**).

The following statistics are presented per channel:

- **Channel** indicates the channel number.
- **Longest (ms)** indicates the longest measured disruption time.
- **Shortest (ms)** indicates the shortest measured disruption time.
- **Last (ms)** indicates the duration of the last measured disruption time.
- **Average (ms)** indicates the average duration of all measured disruption times.

Test Results

SDT (Multi-Channel OTN)

- **Total (ms)** indicates the total duration of all measured disruption times.
- **Count** indicates the number of disruption events detected since the beginning of the test.
- **PASS FAIL**, available when pass/fail verdict is enabled, indicates the SDT pass/fail verdict.

- **Time Mode** selects the format used to display the disruption time.
 - Relative** displays SDT events based on the time elapsed since the beginning of the test.
 - Absolute** (default) displays SDT events based on date and time.
- **Units** selects the unit used to display SDT statistics: μ s, ms (default), s, or min.
- **Time Stamp** displays the time or date/time for each SDT channel; this apply to **Longest** and **Last** disruption time statistics. Choices are **None** (default), **Time**, and **Date/Time**. An extra line is added for each channel to display the time, and two lines to display the time and date.

Note: *When a disruption event is equal to or longer than the test period which is fixed to 5 minutes, then the measured disruption time is equal to the test period.*

Service Configuration - Burst

From the **Test** menu, tap **Results**, **Service Configuration**, and the **Burst** tab.

Service Name and Selection

Service Name indicates the name of the selected service.

Select the service to be displayed by either using the left/right arrow or by tapping over the service numbers area then tapping on a specific service number. An orange background indicates the selected service while a green background indicates the services that are enabled.

Committed/Excess

- **Committed - Burst test** is the **CBS** subtest.
- **Excess - Burst test** is the **EBS** subtest.
- **Direction**, available with **Dual Test Set** or **Dual Port** topology, indicates respectively results from local to remote (**L->R**) and remote to local (**R->L**), or P1 to P2 (**P1->P2**) and P2 to P1 (**P2->P1**).
- **Burst Size** indicates the size in bytes of the burst used for each subtest.
- **SLA Verified** indicates the committed SLA parameters that are used to declare the pass/fail verdict. See *Summary (EtherSAM)* on page 485 for more information on **Frame Loss**, **Max Jitter**, **Round-Trip Latency**, **Max Latency**, and **Max RX Rate**.
- **Informational** parameters are for information purpose only, they are not included in the test pass/fail verdict. See *Summary (EtherSAM)* on page 485 for more information on **Frame Loss Rate**, **Max Jitter**, **Max Latency**, and **Round-Trip Latency**.
- **Average RX Rate** indicates the measured average utilization throughput for the CBS subtest.

Service Configuration - Ramp

From the **Test** menu, tap **Results**, **Service Configuration**, and the **Ramp** tab.

Service Name and Selection

Service Name indicates the name of the selected service. Select the service to be displayed by either using the left/right arrow or by tapping over the service numbers area then tapping on a specific service number. An orange background indicates the selected service while a green background indicates the services that are enabled.

Committed/Excess Steps

- **Committed Steps** indicate the pre CIR and CIR steps specified in the ramp configuration.
- **Excess Steps** indicate the **CIR+EIR** and **Traffic Policing** steps specified in the ramp configuration.
- **Direction**, available with **Dual Test Set** or **Dual Port** topology, indicates respectively results from local to remote (**L->R**) and remote to local (**R->L**), or P1 to P2 (**P1->P2**) and P2 to P1 (**P2->P1**).
- **TX Rate** indicates the transmission rate for each step.
- **SLA Verified** indicates the committed SLA parameters that are used to declare the pass/fail verdict. See *Summary (EtherSAM)* on page 485 for more information on **Frame Loss Rate**, **Max Jitter**, **Round-Trip Latency**, and **Max RX Rate**.

- **Informational** parameters are for information purpose only, they are not included in the test pass/fail verdict. See *Summary (EtherSAM)* on page 485 for more information on **Frame Loss**, **Max Jitter**, and **Round-Trip Latency**.
- **Average RX Rate** indicates the measured average utilization throughput for each step.

Service Performance

From the **Test** menu, tap **Results**, and the **Service Performance** tab.

Service Name and Selection

Service Name indicates the name of the selected service.

Select the service to be displayed by either using the left/right arrow or by tapping over the service numbers area then tapping on a specific service number. An orange background indicates the selected service while a green background indicates the services that are enabled.

SLA Parameters

The configured **CIR**, **Max Jitter**, **Frame Loss Rate** and **Max Latency/Max Round-Trip Latency** SLA parameters are displayed. Refer to *Services - Profile* on page 280 for more information. For **Dual Test Set** or **Dual Port** topology, parameters are displayed respectively for both local to remote (**L->R**), remote to local (**R->L**) directions, or P1 to P2 (**P1->P2**) and P2 to P1 (**P2->P1**).

Metrics

Current, **Average**, **Minimum**, **Maximum**, and **Estimate (Jitter)** measured values for each metric are reported. **Direction**, available with **Dual Test Set** or **Dual Port** topology indicates respectively results from local to remote (**L->R**) and remote to local (**R->L**), P1 to P2 (**P1->P2**) and P2 to P1 (**P2->P1**), and Round-Trip for Latency when in Round-Trip Latency Measurement Mode (see *Global Options* on page 168). For **Dual Test Set**, results for remote to local are obtained at the end of each step.

- **RX Rate** indicates the measured utilization throughput.
- **Jitter (ms)** indicates the measured delay variation.
- **Latency (ms)** indicates the measured round-trip latency (delay).

Note: For the **Current** value, 0 is displayed when no RX rate has been measured in the last second.

Note: Delay variation measurements smaller than 15 μ s will be discarded, not used for the sampling process, and < 0.015 is displayed as the minimum value. For the **Current** value, **Not measurable** is displayed when no delay has been measured in the last second..

Errors

For **Dual Test Set**, errors are reported for both local to remote (**L->R**) and remote to local (**R->L**). For **Dual Port** topology, errors are reported for both P1 to P2 (**P1->P2**) and P2 to P1 (**P2->P1**).

- **Frame Loss** indicates that a sequence number is missing in the received frames. The pass/fail verdict when enabled reports only the verdict when it is fail. **Seconds, Count, and Rate values are reported.**
- **Out-of-Sequence** indicates that the received frame sequence number is either smaller than the expected frame sequence number or is a duplicate number. The Out-Of-Sequence will not be considered in the global verdict. **Seconds, Count, and Rate values are reported.**

RX Frame Count

The **RX Frame Count** indicates the number of frames received matching the selected service ID. For **Dual Test Set**, the count is reported for both local to remote (**L->R**) and remote to local (**R->L**). For **Dual Port** topology, the count is reported for both P1 to P2 (**P1->P2**) and P2 to P1 (**P2->P1**).

Streams - Frame Loss / Out-of-Sequence

From the **Test** menu, tap **Results, Streams**, and the **Frame Loss / Out-Of-Sequence** tab.

- The **P1** and **P2** buttons, available with **Dual Port** topology, allow respectively displaying results for port #1 (**P1**) or port #2 (**P2**).
- **Stream**: Indicates the stream identification number.
- **Thresholds** button allows setting the pass/fail thresholds (refer to *QoS Metrics* on page 321).
- **Frame Loss**: See *QoS Metrics* on page 391.
- **Out-Of-Sequence**: See *QoS Metrics* on page 391.

Streams - Jitter

From the **Test** menu, tap **Results, Streams**, and the **Jitter** tab.

- The **P1** and **P2** buttons, available with **Dual Port** topology, allow respectively displaying results for port #1 (**P1**) or port #2 (**P2**).
- **Stream**: Indicates the stream identification number.
- **Jitter (ms)** is measured for each stream on all valid frames (in-sequence frames, valid Jitter tag, and no FCS error) received. **Current, Average, Minimum, Maximum, and Estimate** delay values are reported.

Note: *Delay variation measurements smaller than 15 μ s will be discarded, not used for the sampling process, and “< 0.015” will be displayed as the minimum value. For the **Current** value, **Not measurable** is displayed when no delay has been measured in the last second.*

- **Thresholds** button allows setting the pass/fail thresholds (refer to *QoS Metrics* on page 321).

Streams - Latency

From the **Test** menu, tap **Results**, **Streams**, and the **Latency** tab.

- The **P1** and **P2** buttons, available with **Dual Port** topology, allow respectively displaying results for port #1 (**P1**) or port #2 (**P2**).
- **Stream**: Indicates the stream identification number.
- **Latency (ms)** is measured for each stream on all valid frames (valid Latency tag, expected originator identifier value, and no FCS error) received. **Current**, **Average**, **Minimum**, and **Maximum** round-trip latency (delay) are reported.

Note: *Latency statistics are only available in loopback test topology.*

Note: *Delay measurements smaller than 15 μ s will be discarded, not used for the sampling process, and < 0.015 will be displayed. For the **Current** value, **Not measurable** is displayed when no delay has been measured in the last second.*

- **Thresholds** button allows setting the pass/fail thresholds (refer to *QoS Metrics* on page 321).

Streams - Throughput / Customer Frame Throughput

From the **Test** menu, tap **Results**, **Streams**, and the **Throughput** or the **Customer Frame Throughput** tab.

- The **P1** and **P2** buttons, available with **Dual Port** topology, allow respectively displaying results for port #1 (**P1**) or port #2 (**P2**).
- **Stream** indicates the stream identification number.
- **TX Rate** indicates the transmitted throughput rate.
- **RX Rate** is measured for each stream on all valid frames (valid Throughput tag with no FCS error). **Current**, **Average**, **Minimum**, and **Maximum** throughput results are reported. Refer to *Unit* on page 314 for unit selection.

Note: A **Current** value of **0** indicates that no RX rate has been measured in the last second.

- **Total** indicates the total TX and current measured RX throughput of all valid frames (valid Throughput tag with no FCS error).
- **Thresholds** button allows setting the pass/fail thresholds (refer to *QoS Metrics* on page 321). Not available on **Customer Frame Throughput** tab.

Summary

Note: Available with Transport, and Ethernet (EtherBERT, Through Mode, Smart Loopback), and Wireless test applications. For other test applications see the corresponding test summary page.

From the **Test** menu, tap **Results**, and the **Summary** tab.

- **Global** (default), **P1**, and **P2** buttons, available with **Dual Port** topology, allow respectively displaying a brief test summary for both ports or a full summary for either port #1 (**P1**) or port #2 (**P2**).
- **Status** indicates the actual test status as follows:
 - “--”: The test is not running or results are not available.
 - **In Progress**: The test is running.
 - **Completed**: The test is completed, stopped at the planned time, or manually stopped when there is no set timer.
- **Start Time** indicates the date and time the test was started. The date and time is reset every time the test is restarted or reset.
- **Test Recovery**, when displayed, indicates that the test has automatically recovered from a power failure. The number of occurrences is also displayed next to the **Test Recovery** field. Refer to *Power Failure Recovery* on page 659.
- **Logger Full**, when displayed, indicates that the logger is full. Refer to *Logger* on page 432.

Test Results

Summary

Interface

Note: Only available with CPRI/OBSAI Unframed test application.

➤ **Alarms**

LOS indicates that there is no input signal.

➤ **Errors**

CV (Code Violation) indicates that invalid 10B code word are received.

BER and Multi-Pattern BER

Note: See BER on page 350 for a description of each alarm/error.

Note: For Multi-Pattern, alarms/errors are available for each pattern. An arrow in front of a specific pattern indicates the pattern that is currently generated/analyzed. **All** represents the sum of alarms/errors as well as the consolidated rate for all patterns.

- **Receiving Live Traffic - RX Pattern Analysis Disabled** when displayed, indicates that the **No Pattern Analysis (Live)** check box is selected and in this case no other information/statistics are available.
- **BER Threshold** is available when **Pass/Fail Verdict** is enabled¹.
- **Restart Sequence** button, available with multi-pattern, clears results and restarts the multi-pattern sequence with the first enabled pattern in the list. This is the only way to restart the multi-pattern sequence and to allow synchronization between two test sets.

For back-to-back testing using two test sets, create a multi-pattern test on both units, tap the **Restart Sequence** button on each unit within 5 seconds apart. Once synchronized, start the test on each unit.

1. Refer to *BERT and Unframed BERT* on page 139 or *EtherBERT, FC BERT, BERT (CPRI/OBSAI), and Unframed BERT* on page 155.

- **Bit/Pattern Error Rate/Count** graphically displays a meter representing either the bit/pattern error rate or the bit/pattern error count depending on the Pass/Fail Verdict selection¹.

When the verdict is enabled¹, the values under the threshold are presented in green while the values above are in red.

When the verdict is disabled, the bit/pattern error rate is displayed in blue.

The arrow pointer indicates the current received bit/pattern error rate/count.

The Pass/Fail verdict is displayed just on top of the meter when enabled¹.
- **Bit/Pattern Error, Amount/Rate, and Inject:** The bit/pattern error injection and settings are coupled with the *Inject Button* on page 413. For Transport test applications, not available in Through modes.

Service Disruption

Note: *Service Disruption results are only available with Transport, CPRI/OBSAI, and EtherBERT test applications when **Disruption Monitoring** is enabled (refer to BERT and Unframed BERT on page 139 or EtherBERT, FC BERT, BERT (CPRI/OBSAI), and Unframed BERT on page 155). When Service Disruption is disabled, the message **Service disruption monitoring disabled** is displayed.*

Service Disruption is the time during which there is a disruption of service due to the detection of defects.

➤ **Disruption Time**

Note: *For OTL defects, at the exception of LOL, the disruption time is displayed for the lane having the longest disruption time. See OTL-SDT on page 437 for results per lanes.*

Longest (ms): Indicates the longest measured disruption time.

Shortest (ms) indicates the shortest measured disruption time.

Last (ms) indicates the length of the last measured disruption time.

Average (ms) indicates the average duration of all measured disruption times.

Total (ms) indicates the total duration of all measured disruption times.

- **Defect**, available with Transport test applications, indicates on which layer and defect the service disruption time test is performed. For OTL defect (parallel interface) also indicates within parenthesis the lane number having the longest disruption time.
- **Disruption Count:** Indicates the number of disruption events detected since the beginning of the SDT test.

Note: When a disruption event is equal to or longer than the test period which is fixed to 5 minutes, then the measured disruption time is equal to the test period.

- **SDT Threshold (ms)** allows entering the SDT threshold value that will be used to declare the pass/fail verdict: 0.005 to 299999.995 ms in step of 0.005 ms (default is **50** ms). This setting is only accessible when Pass/Fail Verdict is enabled and is coupled with the SDT Threshold set from the test setup (refer to page 144).

GFP Frames

GFP Frames are available for OTN BERT with Ethernet 1 GbE, 10 GbE or Ethernet (flex/GFP-F) client (see *GFP-F/GFP-T* on page 423).

Traffic / Traffic Ethernet

Note: The *Traffic* statistics are available for Smart Loopback , Through Mode, and OTN BERT (with EoOTN client) test applications. See Traffic - Ethernet on page 528 for more information.

CPRI

Note: Available with CPRI Framed L2.

- **Sequence** indicates the last Sequence State parameter: **Standby (A)**, **L1 Sync (B)**, **Protocol (C)**, **L2 C&M (D)**, **Vendor (E)**, **Operation (F)**, and **Passive (G)**. The pass/fail verdict is also displayed when enabled.
- **Frame Sync** indicates that the startup sequence synchronization status as per L1 Sync Status parameter: active (green) or inactive (red).
- **Protocol** indicates either the last received (**Version 1** or **Version 2**) or negotiated (**Auto**) protocol version. A red background indicates a Protocol version mismatch.

Test Results

Summary

- **C&M** indicates either the received (HDLC or Ethernet) or negotiated (Auto) C&M for Ethernet subchannel and HDLC rates in Mbit/s. A red background indicates either a C&M type mismatch or HDLC Rate/Ethernet subchannel mismatch. An arrow is displayed indicating which C&M Channel, Ethernet or HDLC, is selected following the negotiation process.
- **Code Word** (CW) indicates the transmitted and received Code Word count.
- **Hyperframe** indicates the transmitted and received hyperframe count.
- **L1 Reset**, available when **Remote Radio Head** emulation mode is selected, indicates the number of times a request to reset the RRH interface was received.

OBSAI

Note: Available with OBSAI Framed L2.

- **Sync** indicates the RX State Machine status: green for FRAME_SYNC, red for other states, or gray for pending. The TX and RX State Machines are also displayed.
The pass/fail verdict is displayed when enabled.
- **Code Word** reports the count of code words transmitted and received.
- **Message Group** reports the count of message groups transmitted and received.
- **Frame** reports the count of frames transmitted and received.
- **RP3 Peer Target Address** indicates the RP3 Peer Target Address; indicates a mismatch when displayed in red.

RX Frequency

Note: *RX Frequency is available for Through Mode test application on both ports (Port 1 and Port 2) for rates up to 10G LAN. Not available for a port using an active copper SFP.*

- **Frequency (GHz)** indicates the frequency of the input signal.
- **Offset (ppm)** indicates the frequency offset between the standard rate specification and the rate at the input signal.

Note: *For both **Frequency** and **Offset** the following background colors are used.*

Background color	Description
Green	The frequency is in range.
Red	The frequency is out-of-range or LOC Lane. LOC is also displayed.
Gray	Pending state.

Test Results

Summary (1588 PTP)

Summary (1588 PTP)

From the **Test** menu, tap **Results**, and the **Summary** tab.

- **Test Status** displays the current status of the 1588 PTP test. The global test pass/fail verdict is displayed next to the **Test Status** field when enabled (see *Pass/Fail Verdict* on page 138).

Test Status	Description
--	Idle state, the test is not running or results are not available.
In Progress	The test is running.
Completed	The test is completed, stopped at the planned time, or manually stopped when there is no set timer.
Aborted	The test is interrupted; stopped before the set timer. For G.8265.1: [Message type] Request Denied , Session Canceled , or No Reply is displayed next to Aborted when applicable. For G.8275.1: Sync Message Rate Changed is displayed next to Aborted when applicable.

- **Start Time** indicates the date and time the test was started. The date and time is reset every time the test is restarted or reset.
- **Test Recovery**, when displayed, indicates that the test has automatically recovered from a power failure. The number of occurrences is also displayed next to the **Test Recovery** field. Refer to *Power Failure Recovery* on page 659.
- **Logger Full**, when displayed, indicates that the logger is full. Refer to *Logger* on page 432.

➤ **Negotiation Status**

The status of the PTP Negotiation is displayed while in Unicast negotiation (available with G.8265.1 profile).

Negotiation Status	Description	Background Color^a
Request Granted	All the Signaling request types have been granted.	Green
[Message type] Request Denied	The Signaling grant message has not been granted.	Red
Session Canceled	The Grand Master has canceled the Unicast session.	Red
No Reply	No message is received from the Grand Master following transmission of 3 Signaling requests for a message type. Make sure that both IP address and Domain (refer to <i>1588 PTP</i> on page 132) of the Grand Master Clock are valid as well as the IP address of the unit's port used to connect on the network (refer to <i>Network</i> on page 220).	Red
Pending	Unicast negotiation has started and no message has been received from the Grand Master.	Gray
Inactive	The Unicast negotiation is not active.	Gray

- a. The gray background color is also used for a Link Down.

Test Results

Summary (1588 PTP)

➤ GM Info

Note: Only available when Grand Master clock information is available.

The Grand Master Information window displays the decoded clock information.

For G.8265.1 only:

- **Identity** reports the 8-byte identification code of the Grand Master Clock.

For G.8275.1 only:

- **Port Identity** reports the identity type of the PTP port.
- **GM Identity** reports the clock identity of the Grand Master Clock.
- **Priority 1** reports the priority 1 attribute of the Grand Master Clock.
- **Priority 2** reports the priority 2 attribute of the Grand Master Clock.
- **Steps Removed** reports the number of communication paths crossed between the local clock and the Grand master Clock.
- **Log Message Interval (Announce)** reports the mean time interval between successive Announce messages.
- **Log Message interval (Sync)** reports the mean time interval between successive Sync messages.

For both G.8265.1 and G.8275.1:

- **Clock Class** reports the description and code of the Grand Master Clock Class.

Code	Description
0-5, 8-12, 15-51, 53-57, 59-67, 123-132, 171-186, 188-192, 194-215, 233-247, 249-254	Reserved
6	Sync to primary reference
7, 14	Holdover
13	Sync to application-specific reference
52, 58, 187, 193	Degraded
68 to 79, 81-109 (odd values), 11-122, 133-170, 216-232	Alternate PTP profiles
80-110 (even values) ^a	Quality Level (QL-xxx ^a)
248	Default
255	Slave only

a. Refer to QL table on page 448 for the list of Quality Level values that will be used as the description.

- **Clock Mode** reports the description of the Grand Master Clock Mode: **Two-step** or **One-step**.
- **Clock Accuracy** reports the accuracy of the clock.
- **Time Source** reports the source of time used by the Grand Master Clock.
- **Start Time** indicates the time the test was started.

Test Results

Summary (1588 PTP)

Delay Measurement

- **Sync IPDV** meter displays the average of the inter packet delay variation of consecutive Sync messages in the last second. The value and the pass/fail verdict is also displayed when enabled.
- **Delay Req IPDV** meter displays the average of the inter packet delay variation of consecutive Delay Req messages in the last second. The value and the pass/fail verdict is also displayed when enabled.

Note: When a value is below 1 μ second, “< 1 μ s” is displayed.

Note: When the Pass/Fail verdict is enabled, the green region is delimited from 0 to the IPDV Threshold (refer to Alarm Timeout/Threshold on page 137) corresponding to a **PASS** verdict. The red region beyond the threshold corresponds to a **FAIL** verdict. There is neither green nor red region when the Pass/Fail verdict is disabled.

Quality Level

- **Last QL Received** indicates the last Quality Level received. The pass/fail verdict is also displayed when both **QL Mismatch Monitoring** and **Pass/Fail Verdict** check boxes are selected.
- **Last Change** indicates the date and time of the Last QL change.

Total PTP Messages

Gives respectively the total count of transmitted (TX) and received (RX) PTP messages.

Summary (Cable Test)

From the **Test** menu, tap **Results**, and the **Summary** tab.

Test Status

Test Status indicates the progress of the cable test as follows:

- **Idle** (test has not started)
- **In Progress**
- **Completed**

The Pass/Fail verdict is displayed next to the **Test Status** field, when enabled, based on the following criteria: **The worst pair's Wire Map, Prop. Delay, Delay Skew, and Length.**

Start Time

Indicates the date and time the test was started. The date and time is reset every time the test is restarted or reset.

Cable

Note: *When no value is available, "--" is displayed.*

- **Wire Map** indicates the Wire Map result for the pair having the worst Wire Map. The distance to fault is also displayed when a fault is identified. The Pass/Fail verdict is also displayed, when enabled.
- **Prop. Delay (ns)** indicates the propagation delay value for the pair having the longest propagation delay. The Pass/Fail verdict is also displayed when enabled.

Test Results

Summary (Cable Test)

- **Delay Skew (ns)** indicates the delay skew value for the pair having the worst delay skew. The Pass/Fail verdict is also displayed when enabled. The Delay Skew result is only available for 1000 Base-T interface when the link is up.
- **Length (m/ft)** indicates the length for the pair having the worst cable length value. The Pass/Fail verdict is also displayed when enabled.

Pairs

Note: When no value is available, "--" is displayed.

- **Pair** indicates the pair number.
- **Pins** indicates the pair's pin numbers and color of each wire corresponding to the selected wiring standard.

W-BL	White-Blue
BL	Blue
W-O	White-Orange
O	Orange
W-G	White-Green
G	Green
W-BR	White-Brown
BR	Brown

- **Wire Map Test Result** gives the wire map test result for each pair. When the link is up: The wire map result for each pair is given as seen by the module to get a link up. This means that the wire map result may not correspond to the type of cable tested depending on the cable(s) used and/or the configuration of the cable mode (MDI, MDIX, or auto-detection) on both the module and the far end equipment. For example, two crossed pair cables end to end used between the module and a far end equipment may give a straight pair (MDI) wire map result.

MDI	Straight pair.
MDIX	Crossed pair.
MDI (-)	For 1 Gbit/s, straight pair with swapped wires within pair.
MDIX (-)	For 1 Gbit/s, crossed pair with pair A swapped with pair B and/or pair C swapped with pair D.
Noise	Excessive noise on a pair most likely caused by a link partner running in 10/100 Mbit/s forced mode. In this case, no propagation delay or length is reported and there is no comparison with any threshold.

Note: *For 1 Gbit/s, both MDI and MDIX can be reported simultaneously since crossed pairs detection is performed independently for pairs A-B and C-D.*

Test Results

Summary (Cable Test)

When the link is down:

Short	Short-circuit between Tip and Ring wires of a pair or Tip or ring wire of a pair is connected with an alien wire grounded.
Open	No cable plugged in, remote end open, or either one or two wires of a pair are not connected.
Short-between-pairs	Short between one or two wires of a pair with one or two wires of another pair. Short between more than two pairs, including one or two wires for each pair.
Noise	Excessive noise on a pair most likely caused by a link partner running in 10/100 Mbit/s forced mode. In this case, no distance is reported and there is no comparison with any threshold.
Unknown	No fault has been identified but the link is down. To maximize the cable test result, it is preferable to have the far end equipment powered up.

If the determined **Wire Map** is either **MDI**, **MDIX**, **MDI (-)**, **MDIX (-)**, or **Noise** (Link up), the test is declared as **PASS**. If the determined Wire Map is either **Short**, **Short-between-pair**, **Open**, **Noise** (Link down), or **Unknown**, the test is declared as **FAIL**.

Note: Refer to Ethernet Cables on page 708 for cable pinout.

- **Distance To Fault (m/ft)** gives the distance to fault from the near end for each pair, unless the problem is due to excessive noise. Noise may be due to electrical noise causing communication error.
- **Prop. Delay (ns)** indicates the propagation delay of a signal through each pair.
- **Length (m/ft)** indicates the cable length of each pair.

PoE

Note: Only available on 8870/8880.

Detection/Classification

- **Power Presence** indicates on which cable pairs (refer to **Wiring Standard** on page 145) the power is received and the polarity of each pair. Result is presented as follows:

Power Presence	Description
Pos: <pair>; Neg: <pair>	PSE applies power on 2 pairs.
Pos: <pair>,<pair>; Neg: <pair>,<pair>	PSE applies power on all pairs.
No power detected	No power over Ethernet was detected.

- **PSE Type** indicates the detected PSE type.
- **Granted Power Class** indicates the power class provided by the PSE:

Granted power Class	Description
0	Class 0 (13.0W)
1	Class 1 (3.8W)
2	Class 2 (6.5W)
3	Class 3 (13.0W)
4	Class 4 (25.5W)
None	The PSE denied power.

The Pass/Fail verdict is also displayed when enabled.

Test Results

Summary (Cable Test)

Operation

Note: *The following results are only reported when the classification succeeded.*

- **Unloaded Voltage (V)** indicates the measured voltage when no load is applied. A value less than 5 is reported as **<5.0** and a value greater than 59 is reported as **>59.0**.
- **Loaded Voltage (V)** indicates the measured voltage by applying a load corresponding to the configured power class. A value less than 5 is reported as **<5.0** and a value greater than 59 is reported as **>59.0**. The Pass/Fail verdict is also displayed when enabled.
- **Current (mA)** indicates the current which is calculated based on the measured **Loaded Voltage** and the applied load.
- **Power (W)** indicates the power in watt which is calculated based on the measured **Loaded Voltage** and **Current**.

Summary (EtherSAM)

From the **Test** menu, tap **Results**, and the **Summary** tab.

Note: For *Dual Test Set*, only *Start Time* is displayed on the remote module.

- **Service Configuration/Performance Test Status** indicates the actual test status as follows:

Test Status	Description
"--"	Test has not started.
Disabled	Test/subtests is/are disabled.
Running	Test/subtest is currently running.
Data Transfer	Test/subtest is running but no test traffic is being transmitted.
Completed, <Verdict>	Test/subtest has completed with the test pass/fail verdict. A fail verdict is declared when a Link Down or LOS is detected, or when any SLA parameter fails.
Aborted, <reason>	Test/subtest has been aborted either manually (Stop) or automatically from an alarm and the reason why the test has been aborted is also displayed as follows: Link down alarm, LOS alarm, Timeout during execution, DTS connection failed, Loss of remote connection (DTS), LOPPS-L Alarm^a, LOPPS-R Alarm^a, LOPPS-L / LOPPS-R Alarm^a, Unresolved addresses, No test enabled, Invalid Burst Configuration, CIR disabled for all services, Excessive Refill Time^b, Stopped, NAT detection failed, Missing DTS-NAT SW option

- a. Available for **Dual Test Set** in **One-Way Latency** measurement mode.
- b. An excessive refill occurs when the pre-burst and/or post-burst duration last for more than 2 seconds.

- **Start Time** indicates the date and time the test was started. The date and time is reset every time the test is restarted.
- **Remote unit in use and locked for Dual Test Set** indicates that this module is used for **Dual Test Set** as the remote module.

Test Results

Summary (EtherSAM)

- **Remote unit in Dual Test Set Mode** indicates that this module is set as remote but the DTS Connection is not established.
- **Service Configuration/Performance Test:** Tap **Service Configuration Test** or **Service Performance Test** button to view the result summary of the corresponding test.
 - **Service** indicates the service's number and name. For **Service Configuration Test**, the number/name is highlighted in red per service when VLAN mismatch occurred; in **Dual Test Set** or **Dual Port** topology, the direction is also highlighted; in Dual Test Set, the **R -> L** direction label is gray when **VLAN Preservation** is not supported by the remote module.
 - **Direction**, available with **Dual Test Set** or **Dual Port** topology, indicates respectively results from local to remote (**L->R**) and remote to local (**R->L**), or P1 to P2 (**P1->P2**) and P2 to P1 (**P2->P1**).
 - **Service Performance Test** column displays the pass/fail verdict icon indicating if the service complies to the configured SLA parameters.
 - **Service Configuration Test** column displays the pass/fail verdict icon indicating if the service complies to the configured SLA parameters.

Committed

- **Frame Loss Rate** indicates the rate of frames that are lost. The reported value is the maximum rate of Frame Loss from all burst sequences and ramp steps excluding the **CIR+EIR**, **EBS**, and **Traffic Policing** steps. Frame Loss is displayed as a percentage value when the remote module does not support exponential notation.
- **Max. Jitter (ms)** indicates the maximum measured delay variation.
- **Max Latency (ms)** indicates the maximum measured round-trip latency (delay). For Dual Test Set the local to remote and remote to local values are reported for One-Way Latency Measurement Mode while a single round-trip value is reported for Round-Trip Latency Measurement Mode (see *Global Options* on page 168).
- **Avg RX Rate**, for **Service Performance Test**, indicates the measured average utilization throughput.

Excess

- Max RX Rate**, for **Service Configuration Test**, indicates the measured maximum utilization throughput.
- **VLAN Preservation** indicates if any VLAN mismatch occurred during any step of a Ramp or Burst tests as follows:
 - Grey: Undefined
 - Green: No Mismatch detected
 - Red: Mismatch detected

Summary (FC BERT)

From the **Test** menu, tap **Results**, and the **Summary** tab.

- **Test Status** indicates the actual test status as follows:
 - “--”: The test is not running or results are not available.
 - **In Progress**: The test is running.
 - **Completed**: The test is completed, stopped at the planned time, or manually stopped when there is no set timer.

Once the test is stopped, the test pass/fail verdict is displayed next to the **Status** field when enabled. The verdict is Pass when all verdicts are Pass, the verdict is Fail as soon as one of the verdict is Fail. Refer to *Bit/Pattern Error* on page 156 and *Latency Tag Insertion* on page 159 for more information.

- **Start Time** indicates the date and time the test was started. The date and time is reset every time the test is restarted or reset.
- **Test Recovery**, when displayed, indicates that the test has automatically recovered from a power failure. The number of occurrences is also displayed next to the **Test Recovery** field. Refer to *Power Failure Recovery* on page 659.
- **Logger Full**, when displayed, indicates that the logger is full. Refer to *Logger* on page 432.

BER

Note: See BER on page 350 for a description of each alarm/error.

- **BER Threshold** is available when **Pass/Fail Verdict** is enabled (refer to page 156).
- **Bit Error Rate/Count** graphically displays a meter representing either the bit error rate or the bit error count depending on the Pass/Fail Verdict selection (refer to page 156).

When the verdict is enabled, the values under the threshold are presented in green while the values above are in red.

When the verdict is disabled, the bit error rate is displayed in blue.

The arrow pointer indicates the current received bit error rate/count.

The Pass/Fail verdict is displayed just on top of the meter when enabled.

- **Bit Error and Rate/Amount**
 - **Manual** allows entering the amount of manual error to be generated: **1** (default) through **50**.
 - **Rate** allows the selection of the injection rate for the selected error.
 - **Max Rate** generates the selected error to its theoretical maximum rate.
- **Inject** generates, if the test is running, the amount of bit error configured.

Test Results

Summary (FC BERT)

Round-Trip Latency

- **Round Trip Latency (ms)** is measured for each local and remote port.
Current, Average, Minimum, and Maximum indicates respectively the current, average, minimum, and the maximum round trip latency from the local to the remote port in the last one second. The pass/fail verdict is also displayed for the maximum round trip latency.
Samples indicates the number of samples used for the round trip latency.
- **Estimated BB_Credit** indicates the estimated number of packets that can be transmitted on the optical line at the same time.
- **Round-Trip Latency Threshold (ms)** sets the round trip latency threshold: **0.015 to 8000 ms** (default is **15**). This setting is only available when both **Latency Tags** and **Pass/Fail Verdict** check boxes are selected (refer to *Latency Tag Insertion* on page 159).

Traffic

- **Line Utilization (%)** indicates the current percentage of the transmitting/receiving line rate utilization.
- **Frame Rate (frame/s)** indicates the current transmitted/received number of frames (including frame with error and aborted frames) in frame per second.
- **Byte Count** indicates the total number of transmitted/received bytes including the frame delimiters.
- **Frame Count** indicates the total number of transmitted/received frames including link service control frames.

Summary (iOptics)

From the **Test** menu, tap **Results**, and the **Summary** tab.

Start Time indicates the date and time the test was started. The date and time reset every time the test is restarted.

When necessary for power consumption monitoring the **Calibrating** progress message is displayed. If at any point during this process or during a sub-test execution an unexpected condition is detected, an abort message is displayed as follows:

Test Status	Description
Aborted, <reason>	Sub-test sequence has been aborted and a reason is displayed: Missing Optic, Invalid Optic, Laser Off, LOS, Optic Ovrlld (overload), Device Pulled, Failed, or User Stopped .

Sub-Test Sequence

The progress status and pass/fail verdict are displayed for each sub-test sequence as follows:

Test Status	Description
"_"	Sub-test is not running or results are not available.
Running <details>	Sub-test is running and progress details are displayed.
Completed, Pass/Fail	Sub-test is completed with Pass or Fail verdict.
Aborted, Fail	Sub-test sequence has been aborted with a fail verdict.

- **I/O Interface Quick Check:**
 - Validates the operation of the MDIO/I2C interface by sending specific commands to the transceiver.
 - Validates the information provided by a status pin and stimulates a control pin of the transceiver.

Test Results

Summary (iOptics)

- **Optical TX Power Test** (dBm) reports the minimum and maximum optical TX power values; in-range values are displayed in green while out-of-range are in red.
- **Optical RX Power Test** (dBm) reports the minimum and maximum optical RX power values; in-range values are displayed in green while out-of-range are in red.
- **Bit Error Test** reports the bit error count; count value smaller or equal to the BER threshold is displayed in green while bigger value is in red.
- **Excessive Skew Test** reports the highest skew value monitored during the sub-test; a value smaller than the threshold is displayed in green while a value crossing the threshold is in red. Only available for parallel interfaces with the exception of transceivers using RS-FEC (100GBASE-SR4, 100GE-CWDM4, 100GE-CLR4).

Monitoring

- **Power Consumption** graphically displays a meter representing the transceiver power consumption in Watt. Not available on 8870 and 8880 modules.

The **Current (A)** and **Power (W)** values (**Actual** and **Maximum**) for 3.3V source are displayed.
- **Temperature** graphically displays a meter representing the transceiver temperature in °C.

The current (**Actual**) and maximum temperature values are also displayed.

Note: *The green region is delimited from 0 to the Threshold corresponding to a **PASS** verdict. The red region beyond the threshold corresponds to a **FAIL** verdict.*

Summary (iSAM)

From the **Test** menu, tap **Results**, and the **Summary** tab.

- **Start Time** indicates the date and time the test was started. The date and time is reset every time the test is restarted.
- **Configuration/Performance Results** and **RFC 6349 Results** buttons are used to respectively display summary results for **Service Configuration Test** and **Service Performance Test**, or **RFC 6349 Test** when results don't fit on one page.

Service Configuration Test and Service Performance Test

- The actual test status is displayed as follows:

Test Status	Description
"_"	Test has not started.
Disabled	Test/subtests is/are disabled.
Running	Test/subtest is currently running.
Data Transfer	Test/subtest is running but no test traffic is being transmitted.
Completed, <Verdict>	Test/subtest has completed with the test pass/fail verdict. A fail verdict is declared when a Link Down or LOS is detected, or when any SLA parameter fails.
Aborted, <reason>	Test/subtest has been aborted either manually (Stop) or automatically from an alarm and the reason why the test has been aborted is also displayed as follows: Link down alarm, LOS alarm, Timeout during execution, DTS connection failed, Loss of remote connection (DTS), Unresolved addresses, Stopped, NAT detection failed, Missing DTS-NAT SW option

Test Results

Summary (iSAM)

For **Dual Test Set** the following values are reported for both local to remote (**L->R**) and remote to local (**R->L**).

- **Service** indicates the service's number and name.
The pass/fail verdict icon is displayed next to the service name indicating if the service complies to the configured SLA parameters.
- **TX CIR (Mbit/s)** indicates the transmitted Committed Information Rate.
- **FD (ms) (RTT¹) (Latency)** indicates the maximum measured round-trip latency (Frame Delay). The pass/fail verdict is also displayed.
- **IFDV (ms) (Jitter)** indicates the maximum measured Inter Frame Delay Variation. The pass/fail verdict is also displayed.
- **FLR (%) (Frame Loss)** indicates the maximum percentage of frames that are lost (Frame Loss Ratio) from the CIR step. The pass/fail verdict is also displayed.
- **RX Rate (Mbit/s)** indicates either the measured maximum utilization throughput for **Service Configuration Test** or the measured average utilization throughput for **Service Performance Test**. The pass/fail verdict is also displayed.
- **Total RX Rate**, available for **Service Performance Test**, indicates the average utilization throughput for all services (both directions are displayed for **Dual Test Set**).

1. RTT is only displayed for Dual Test Set.

RFC 6349 Test

- **Test Status** indicates the actual test status as follows:

Test Status	Description
"--"	Test has not started.
In Progress	The test is running.
Completed, <Verdict>	Test has completed and the test pass/fail verdict is displayed when enabled. A fail verdict is declared if any of the following conditions occurs: Link Down, LOS, TCP Throughput verdict failed, or an abort condition (Timeout, DTS connection lost, unresolved address, user stopped, configuration synchronization error, invalid MTU).
Aborted, <reason>	Test has been aborted either manually (Stop) or automatically from an alarm and the reason is displayed as follows: Link down alarm, LOS alarm, Timeout during execution, DTS connection failed, Invalid Configuration, Unresolved addresses, Invalid MTU, User Stopped, TCP Timeout, TCP Connection failed, NAT detection failed, Missing DTS-NAT SW option

- **MTU (bytes)** is the validated Maximum Transfer Unit.
- **Minimum RTT (ms)** is the minimum time between the first bit of a segment sent and the last bit of the corresponding acknowledge.
- **TCP Throughput**
 - **Service** indicates the service's number and name. The pass/fail verdict icon is displayed next to the service name. A fail verdict is declared if any of the following conditions occurs: Link Down, LOS, TCP Throughput verdict failed, or an abort condition (Timeout, DTS connection lost, unresolved address, user stopped, configuration synchronization error, invalid MTU).
 - **L->R** and **R->L** indicates respectively the direction from local to remote and remote to local.

Test Results

Summary (iSAM)

- **Window** indicates the total Max Window (1 KiB = 1024 bytes) followed by the number of connections and KiB per connection in parenthesis as follows: (n conn.@ n KiB).
- **Ideal L4** indicates the ideal TCP throughput metric.
- **Actual L4** indicates the average of actual TCP Throughput metric. The pass/fail verdict icon is displayed next to the this metric. A value greater or equal to the defined threshold gives a pass verdict.
- **TCP Efficiency (%)** indicates the TCP Efficiency metric based on transmitted and retransmitted bytes.
- **Buffer Delay (%)** indicates the Buffer Delay percentage metric which represents the increase in RTT during a TCP Throughput test versus the **Minimum RTT**.

Summary (Link OAM)

From the **Test** menu, tap **Results**, and the **Summary** tab.

- **Test Status** displays the current status of the Link OAM test. The global test pass/fail verdict is displayed next to the **Test Status** when enabled (see **Pass/Fail Verdict** on page 324).

Test Status	Description
--	The test is not running or results are not available.
In Progress	The test is running.
Completed	The test is completed, stopped at the planned time, or manually stopped when there is no set timer.
Aborted	The test is interrupted; stopped before the set timer.

- **Start Time** Indicates the date and time the test was started. The date and time is reset every time the test is restarted or reset.
- **Test Recovery**, when displayed, indicates that the test has automatically recovered from a power failure. The number of occurrences is also displayed next to the **Test Recovery** field. Refer to *Power Failure Recovery* on page 659.
- **Logger Full**, when displayed, indicates that the logger is full. Refer to *Logger* on page 432.

Alarms

- **Link OAM** indicates that no OAM Information PDUs were received for 5 seconds.
- **Critical Event**: Indicates that the OAM link partner has sent a critical event notification (bit 2 of the Flags field is set to 1).

Test Results

Summary (Link OAM)

- **Dying Gasp:** Indicates that the OAM link partner has sent an unrecoverable local failure notification (bit 1 of the Flags field is set to 1).
- **Link Fault:** Indicates that the OAM link partner has sent a link fault notification (bit 0 of the Flags field is set to 1).

Loopback

- **Local** indicates the **Status** of the local loopback (**Enabled** or **Disabled**) and allows enabling or disabling it.
- **Remote**¹ indicates the **Status** of the remote loopback (**Enabled** or **Disabled**), the number of **Successful** remote loopback requests, the number of **Fail** remote loopback requests, and allows enabling or disabling it.

OAMPDU Frame Count

- Indicates the number of transmitted and received OAMPDU frames of the following types:
 - **Information**
 - **Loopback Control**
 - **Event Notification** (received only)
- **Total** indicates the total number of transmitted and received OAMPDU frames.

1. Statistics are influenced by both the protocol (Parser Action is set to "01") and physical loopback. The Fail and Successful counters will be affected by successive enable/disable loopback requests when sending a loopback request to a remote module running Link OAM test since it does not provide physical loopback.

Summary (Multi-Channel OTN)

From the **Test** menu, tap **Results**, and the **Summary** tab.

- **Status** indicates the actual test status as follows.
 - “--”: The test is not running or results are not available.
 - **In Progress**: The test is running.
 - **Completed**: The test is completed, stopped at the planned time, or manually stopped when there is no set timer.
- **Start Time** indicates the date and time the test was started. The date and time is reset every time the test is restarted or reset.
- **Test Recovery**, when displayed, indicates that the test has automatically recovered from a power failure. The number of occurrences is also displayed next to the **Test Recovery** field. Refer to *Power Failure Recovery* on page 659.
- **Logger Full**, when displayed, indicates that the logger is full. Refer to *Logger* on page 432.

Alarms/Errors, Traces, and Payload Type

The results displayed are for the first channel by default. Tap on one of the button described on the next page to select the results to be displayed. The selected button has an amber background.

When a channel button is selected:

- The channel number is displayed indicating the selected channel.
- A channel selector becomes available when zooming a result block allowing to select a specific channel.

Test Results

Summary (Multi-Channel OTN)

Interface / OTL / OTU4, ODU4, and Channel Buttons

Note: Refer to Alarms/Errors on page 346 for more information on alarms/errors and alarms/errors injection.

- **Interface / OTL / OTU4** displays alarms/errors for **Interface** (see page 374), **Clock** (see page 351), **OTL** (see page 385), and **OTU4** (see page 386) as well as the received **SM TTI Traces** (see page 525).
- **ODU4** displays alarms/error at **ODU4** (see page 378) and **OPU4** (see page 383) levels as well as the received **PM TTI Traces** (see page 525) and received **Payload Type** (see page 421).
- **1, 2, up to 80**, depending on the OTN multiplexing, displays alarms/error for a specific channel including: **ODU_x** (see page 378), **OPU_x** (see page 383), **ODTU4.1 - GMP** (see page 373), **BERT** (see page 468), **SDT** (see page 470), received **PM TTI Traces** (see page 525), and received **Payload Type** (see page 421).

Buttons use different background colors representing current and history alarms/errors. An orange background indicates the selected button.

Background color	Alarm/ Error ^a	Description
Gray	Current	No test result available.
	History	
Green	Current	No alarm/error has occurred in the last second.
	History	No alarm/error has occurred during the test.
Red	Current	An alarm/error occurred in the last second.
	History	
Amber	History	At least one alarm/error has occurred during the test.

- a. History background color is presented on the left side of the button while Current background color is covering the rest of the button.

Summary (NI/CSU Emulation)

From the **Test** menu, tap **Results**, and the **Summary** tab.

Status

Status indicates the progress of the test as follows:

- **Idle** (test has not started)
- **In Progress**
- **Completed**

The Pass/Fail verdict is displayed next to the **Test Status** field, when enabled, based on the following criteria: The worst pair's **Wire Map**, **Prop. Delay**, **Delay Skew**, and **Length**.

Start Time

Indicates the date and time the test was started. The date and time is reset every time the test is restarted or reset.

Auto-Response/Manual Loopback Status

Indicates the status of the loopback:

- **Loopback Active**
- **No Loopback.**

Interface

See *Interface* on page 374 for more information on Interface alarms/errors.

DS1

See *DS1* on page 353 for more information on DS1 alarms/errors.

Test Results

Summary (RFC 2544)

Summary (RFC 2544)

From the **Test** menu, tap **Results**, and the **Summary** tab.

- **Start Time** indicates the date and time the test was started. The date and time is reset every time the test is restarted or reset. For **Dual Test Set**, this is the only information available on the remote module.
- **Test Recovery**, when displayed, indicates that the test has automatically recovered from a power failure. The number of occurrences is also displayed next to the **Test Recovery** field. Refer to *Power Failure Recovery* on page 659.
- **Logger Full**, when displayed, indicates that the logger is full. Refer to *Logger* on page 432.
- **Remote unit in use and locked for Dual Test Set** indicates that this module is used for **Dual Test Set** as the remote module.
- **Remote unit in Dual Test Set Mode** indicates that this module is set as remote but the DTS Connection is not established.

Throughput, Back-to-Back, Frame Loss, and Latency Subtests

➤ Throughput, Back-to-Back, Frame Loss, and Latency

For each subtest, its status (-- (Idle), **In Progress**, **Completed**, or **Aborted** - (reason)) and duration are displayed.

- **TX Frames**¹ and **RX Frames**¹ display the transmitted and received frame counts of the subtest in progress. For **Dual Test Set**, frame counts are available for both directions: from local to remote (**L->R**) and remote to local (**R->L**). For Dual Port topology, frame counts are available for both P1 to P2 (**P1->P2**) and P2 to P1 (**P2->P1**).
- **Trial #**¹ displays the current trial iteration of the subtest in progress when applicable.
- **Val. #**¹ displays the current validation iteration of the subtest in progress when applicable.
- **Step**¹ displays the current step of the subtest in progress when applicable.
- **Displayed Results**: Select the displayed result mode: **Current**, **Minimum** (default), **Maximum**, or **Average**.
- **Throughput/Back-to-Back/Frame Loss/Latency** table.

Each frame size used for the test is displayed with its subtest statistics. Statistics values are displayed based on the **Displayed Results** setting.

“--” indicates that the result is not available because the test has not run yet. While testing, one of the following messages is displayed for each frame size: **Initializing**, **Learning**, **Testing**, **Waiting**, **Not measurable**, **Aborted**, **Link is Down**, or **MAC not resolved**.

Dir. (Direction), available with **Dual Test Set** or **Dual Port** topology, indicates respectively results from local to remote (**L->R**) and remote to local (**R->L**), or P1 to P2 (**P1->P2**) and P2 to P1 (**P2->P1**).

1. Only displayed once the test is started.

Test Results

Summary (RFC 2544)

- **Unit:** Select the subtest result unit:
 - For Throughput: **Mbit/s, Gbit/s, frame/s**, and %.
 - For Back-to-Back: **Mbit/s, Gbit/s, frame/burst**, and %.
 - Frame Loss: %.
 - Latency: **ms**, and **μs**.

- **Layer:** For Throughput and Back-to-Back subtests, select the subtest layers used to calculate the throughput.
 - All** (default): Layer 1,2,3 contains the Idle, Preamble, Start of Frame Delimiter, MAC address, IP address, and data.
 - Ethernet:** Layer 2,3 contains the MAC layer, IP layer, and data.
 - IP:** Layer 3 contains the IP layer, and data.

- **Step:** For Frame Loss subtest, selects the step (%) of the testing rate to be displayed.

- **Mode:** For Latency subtest, selects the propagation time mode.
 - Cut Through** (default) allows the calculation of the propagation time of a bit (Bit Latency).
 - S. & F.** (Store and Forward) allows the calculation of the propagation time of a frame (Frame Latency).

Summary (RFC 6349)

From the **Test** menu, tap **Results**, and the **Summary** tab.

- **Status** indicates the actual test status as follows:

Test Status	Description
"--"	Test has not started.
In Progress	The test is running.
Completed, <Verdict>	Test has completed and the test pass/fail verdict is displayed when enabled. A fail verdict is declared if any of the following conditions occurs: Link Down, LOS, TCP Throughput verdict failed, or any abort condition.
Aborted, <reason>	Test has been aborted either manually (Stop) or automatically due to an abort condition, and the reason is displayed as follows: Link Down Alarm, LOS Alarm, DTS Connection failed, No Communication with Remote, Remote is busy, Unexpected response from Remote, Timeout during execution, Invalid Configuration, Unresolved addresses, Invalid MTU, User stopped, TCP Timeout, TCP Connection failed, NAT detection failed, Missing DTS-NAT SW option

- **Start Time** indicates the date and time the test was started. The date and time is reset every time the test is restarted or reset. This is the only information available on the remote module.
- **Test Recovery**, when displayed, indicates that the test has automatically recovered from a power failure. The number of occurrences is also displayed next to the **Test Recovery** field. Refer to *Power Failure Recovery* on page 659.

Test Results

Summary (RFC 6349)

- **Logger Full**¹, when displayed, indicates that the logger is full. Refer to *Logger* on page 432.
- **Remote unit in use and locked for Dual Test Set**² indicates that this module is used for **Dual Test Set** as the remote module.
- **Remote unit in Dual Test Set Mode**² indicates that this module is set as remote but the DTS Connection is not established.

MTU (bytes) is the validated Maximum Transfer Unit.

Minimum RTT (ms) is the minimum time between the first bit of a segment sent and the last bit of the corresponding acknowledge.

Window Sweep

- **L->R** and **R->L** indicates respectively the direction from local to remote and remote to local.
- **Actual L4** indicates for each step the average TCP throughput metric.

TCP Throughput

- **L->R** and **R->L** indicates respectively the direction from local to remote and remote to local.
- **Window (KiB)** indicates the total Max Window (1 KiB = 1024 bytes) followed by the number of connections and KiB per connection in parenthesis as follows: (n conn.@ n KiB).
- **Ideal L4** indicates the ideal TCP throughput metric.
- **Actual L4** indicates the average of actual TCP Throughput metric. The pass/fail verdict icon is displayed next to the this metric when enabled. A value greater or equal to the defined threshold gives a pass verdict.
- **TCP Efficiency (%)** indicates the TCP Efficiency metric based on transmitted and retransmitted bytes.

1. Displayed on local module only.

2. Displayed on Remote module only.

- **Buffer Delay (%)** indicates the Buffer Delay percentage metric which represents the increase in RTT during a TCP Throughput test versus the **Minimum RTT**.
- **TCP Throughput Threshold (% of ideal)** allows entering the TCP Throughput as a percentage of the defined CIR that will be used to declare the pass/fail verdict for both directions: **0** to **100** %; default is 95 %. The calculated throughput based on the selected threshold is displayed for both directions.

Test Results

Summary (S-OAM and MPLS-TP OAM)

Summary (S-OAM and MPLS-TP OAM)

From the **Test** menu, tap **Results**, and the **Summary** tab.

- **Test Status** displays the current status of the S-OAM / MPLS-TP OAM test. The global test pass/fail verdict is displayed next to the **Test Status** when enabled (see **Pass/Fail Verdict** on page 324).

Test Status	Description
--	The test is not running or results are not available.
In Progress	The test is running.
Completed	The test is completed, stopped at the planned time, or manually stopped when there is no set timer.
Aborted	The test is interrupted; stopped before the set timer.

- **Start Time** Indicates the date and time the test was started. The date and time is reset every time the test is restarted or reset.
- **Test Recovery**, when displayed, indicates that the test has automatically recovered from a power failure. The number of occurrences is also displayed next to the **Test Recovery** field. Refer to *Power Failure Recovery* on page 659.
- **Logger Full**, when displayed, indicates that the logger is full. Refer to *Logger* on page 432.

Continuity Check (Peer MEP)

- **Status** displays the status of the continuity check with the peer MEP.

Status	Description
Loss Continuity	Loss of Continuity alarm is active.
Mismerge	Mismerge alarm is active.
Unexpected MEG Level	Unexpected MEG Level alarm is active.
Unexpected MEP	Unexpected MEP alarm is active.
Unexpected Period	Unexpected Period alarm is active.
Unexpected MD Level	Unexpected MD Level alarm is active.
Receiving CCMs	CCM frames from the peer MEP are received without alarms.

- **TX CCM** indicates the count of transmitted CCM frames.
- **RX CCM** indicates the count of valid CCM frames received. A valid frame for S-OAM has its source MAC address matching the Peer MEP MAC address; destination MAC address matching either the unit port Unicast MAC address or a Multicast class 1 address (refer to 757); and VLANs matching the unit port VLANs. A valid frame for MPLS-TP OAM has its destination MAC address matching either the unit MAC address, FF:FF:FF:FF:FF:FF, or 01:00:5E:90:00:00; VLANs matching the unit port VLANs; and MPL Labels matching the local MPLS Label Stack configuration.

Test Results

Summary (S-OAM and MPLS-TP OAM)

- **CCM** indicates the content of the last received CCM frame including **MEG ID** (Y.1731 and G.8113.1), **Domain ID** (802.1ag and MEF), **MA Name** (802.1ag and MEF), **MEG Level** (Y.1731, MEF, and G.8113.1), **MD Level** (802.1ag), **MEP ID**, and **Period**.

For unsupported **Domain ID**, **MA Name**, and **MEG ID**, the **Unexpected Format** message is displayed.

	Supported Format
Domain ID	1 (No Maintenance Domain Name present) 4 (Character String)
MA Name	2 (Character String)
MEG ID	32 (ICC based format) 33 (CC and ICC based format)

Loopback / Test / Frame Delay / Frame Loss / Synthetic Loss

Note: *Either Loopback, Test, Frame Delay, Frame Loss, or Synthetic Loss (available with Ethernet OAM) statistics are displayed according with the selected test function (refer to Test Function on page 273).*

➤ **Status** displays the status of the test function.

For **Loopback, Frame Delay, Frame Loss, and Synthetic Loss** (available with Ethernet OAM) functions:

Status	Description
Idle	No Results (function did not run yet).
In Progress	Test is in progress. Frames are being transmitted and monitored.
Completed	Test is completed: The test with continuous transmission is manually stopped and replies have been received or timed out. The test with continuous transmission is automatically stopped by a test timer and replies have been received or timed out. All frames of the test with non-continuous transmission have been transmitted and replies have been received or timed out.
Aborted	Test is aborted. The test with non-continuous transmission is stopped before all the frames are transmitted.

For **Test** function:

Status	Description
Idle	No Results (function did not run yet).
In Progress	Test is in progress. RX TST frames are being monitored.
Completed	Test is completed. The test is stopped or function is disabled after being In Progress state.

Test Results

Summary (S-OAM and MPLS-TP OAM)

- **RX Line Utilization** meter and value, available with **Loopback** function, indicate the line rate utilization percentage (only LBR frames are considered) received in the last second.
- **TST RX Rate** meter and value, available with **Test** function, indicate the quantity of TST frames received in the last second.
- **Frame Delay** meter and value, available with **Frame Delay** function, indicate the average of the measured frame delays in the last second.
- **Frame Loss Ratio** meter, available with **Frame Loss** function, indicates for both Near-End and Far-End the last measured frame loss ratio in the last second.
- **Synthetic Loss Ratio** meter, available with **Synthetic Loss** function which is available with Ethernet OAM, indicates for both Near-End and Far-End the last measured Synthetic Loss ratio in the last second.

Note: *Refer to S-OAM and MPLS-TP OAM on page 452 for more alarms/errors/statistics information.*

Summary

Refer to *S-OAM and MPLS-TP OAM* on page 452 for more information on alarms.

Thresholds

Refer to *Thresholds* on page 269 for more information.

Summary (SyncE)

From the **Test** menu, tap **Results**, and the **Summary** tab.

- **Test Status** displays the current status of the SyncE test. The global test pass/fail verdict is displayed next to the **Test Status** when enabled (see **Pass/Fail Verdict** on page 324).

Test Status	Description
--	The test is not running or results are not available.
In Progress	The test is running.
Completed	The test is completed, stopped at the planned time, or manually stopped when there is no set timer.
Aborted	The test is interrupted; stopped before the set timer.

- **Start Time** indicates the time the test was started.
- **Test Recovery**, when displayed, indicates that the test has automatically recovered from a power failure. The number of occurrences is also displayed next to the **Test Recovery** field. Refer to *Power Failure Recovery* on page 659.
- **Logger Full**, when displayed, indicates that the logger is full. Refer to *Logger* on page 432.

Test Results

Summary (SyncE)

ESMC

Indicates the current (meter and value), average, minimum, and maximum ESMC frame rate (including information and event frames) received in frame/s. A fail verdict is also displayed beside the minimum and/or maximum values when the ESMC frame rate is outside the range while the Pass/Fail Verdict is enabled.

ESMC RX Rate meter displays the current ESMC frame rate (including information and event frames) in frame/s averaged over the last 11 frames received. The pass/fail verdict is also displayed when enabled.

Note: *When the **Pass/Fail Verdict** and **ESMC Rate Threshold** check boxes are selected (see page 324), the green region is delimited from 0.8 to 10.2 frames/s corresponding to a **PASS** verdict. The red regions above and beyond the threshold correspond to a **FAIL** verdict. There is neither green nor red region when the Pass/Fail verdict is disabled.*

RX

- **Last QL Message** indicates the last Quality Level value received. The pass/fail verdict is also displayed when both **QL Mismatch Monitoring** and **Pass/Fail Verdict** check boxes are selected.

Last Change indicates the date and time of the Last QL Message has changed.

- **Information/Event Count** gives respectively the count of information and event frames generated for all Quality Level values.
- **QL Mismatch Frame Count** gives the total count of information and/or event frames received not matching the expected Quality Level. Only available when the **QL Mismatch Monitoring** check box is selected.
- **Frequency/Offset** indicates respectively the frequency and the offset between the standard rate specification and the rate of the input signal.
- **Max. (-/+) Offset (ppm)** indicates respectively the minimum and maximum offset between the standard rate specification and the largest/smallest rate recorded from the received signal.

TX

- **QL Message** indicates the Quality Level value that is generated.

Last Change indicates the date and time of the QL Message value has changed. For 1GE Electrical interface using **Local Clock** set to **Slave**, the **Last Change** is not available.

- **Information/Event Count** gives respectively the count of information and event frames generated for all Quality Level values. **Event Count** is not available with 1GE Electrical interface using remote local clock.

Test Results

Summary (TCP Throughput)

Summary (TCP Throughput)

From the **Test** menu, tap **Results**, and the **Summary** tab.

- **Test Status** indicates the actual test status as follows:

Test Status	Description
"--"	The test is not running or results are not available.
In Progress	The test is running.
Completed	The test is completed, stopped at the planned time, or manually stopped when there is no set timer.
Aborted - <Reason>	The test is interrupted; stopped before the set timer. Possible <Reason> are: TCP Session Closed or Remote IP Not Found .

- **Start Time** indicates the date and time the test was started. The date and time is reset every time the test is restarted or reset.
- **Test Recovery**, when displayed, indicates that the test has automatically recovered from a power failure. The number of occurrences is also displayed next to the **Test Recovery** field. Refer to *Power Failure Recovery* on page 659.
- **Logger Full**, when displayed, indicates that the logger is full. Refer to *Logger* on page 432.

TCP Throughput

- **TCP Connection Status** indicates the actual TCP connection status.

Test Status	Description
"--"	The test is not running or results are not available.
In Progress	The TCP initialization algorithm is in progress.
Waiting	Indicates on the remote unit that the test is started but the TCP initialization algorithm is not initiated by the local unit.
Established	The TCP session has been successfully established between the local and remote units.
Closed	The session is closed. Either no TCP initialization algorithm has been received, the remote unit has received and completed the request to close the TCP session, or no data has been received at the remote unit for 30 seconds.
Closing	The TCP protocol is closing down the connection.
Remote IP not found	The local unit didn't received an answer to the ARP request sent to the IP address of the remote unit.

- **Transmitted Frames** indicates the total of frames transmitted by the local unit excluding the re-transmitted frames.
- **Re-transmitted Frames** indicates the total of frames that have been re-transmitted by the local unit.
- **Efficiency (%)** indicates the percentage of bytes that were not retransmitted.
- **Window Size Unit** allows selecting the unit used for **Window Size: Bytes, KBytes, or MBytes** (default).
- **Throughput Threshold** allows setting the pass/fail verdict threshold value: **0 to 100 %** (default). This setting is available when the **Throughput Pass/Fail Verdict** check box is selected (refer to *TCP Throughput* on page 327).
- **Throughput** meter displays the last second TCP Throughput measurement.

Test Results

Summary (TCP Throughput)

- **TCP Throughput** displays respectively the last, minimum, maximum, and average TCP Throughput measurement.
- **Window Size** displays respectively the last, minimum, and maximum TCP window size.
- **Round Trip Latency (ms)** displays respectively the last, minimum, maximum, and average round trip time gathered from the TCP Throughput test.

Ethernet Traffic

Note: See Traffic - Ethernet on page 528 for more information.

Summary (Traffic Gen & Mon)

From the **Test** menu, tap **Results**, and the **Summary** tab.

- The **P1** and **P2** buttons, available with **Dual Port** topology, allow respectively displaying the test summary for port #1 or port #2.
- **Test Status** indicates the actual test status as follows. The global test pass/fail verdict is displayed next to the **Test Status** when enabled (see *QoS Metrics* on page 321).
 - “--”: The test is not running or results are not available.
 - **In Progress**: The test is running.
 - **Completed**: The test is completed, stopped at the planned time, or manually stopped when there is no set timer.
- **Start Time** indicates the date and time the test was started. The date and time is reset every time the test is restarted or reset.
- **Test Recovery**, when displayed, indicates that the test has automatically recovered from a power failure. The number of occurrences is also displayed next to the **Test Recovery** field. Refer to *Power Failure Recovery* on page 659.
- **Logger Full**, when displayed, indicates that the logger is full. Refer to *Logger* on page 432.

Stream

The following statistics are available for each stream.

- **Current Throughput**: See *Streams - Throughput / Customer Frame Throughput* on page 466.
- **Frame Loss Rate**: See *Streams - Frame Loss / Out-of-Sequence* on page 464.
- **Jitter**: See *Streams - Jitter* on page 464.
- **Latency**: See *Streams - Latency* on page 465.

Test Results

Summary (Traffic Gen & Mon)

- **Out-of-Sequence:** See *Streams - Frame Loss / Out-of-Sequence* on page 464.
- **Stream** indicates the stream number and provides stream detailed statistics when tapping on its button.

The following statistics are displayed for the selected stream.

- **Stream Selection:** Select a stream by either using the left/right arrow or by tapping over the stream numbers area then tapping on a specific stream number. An orange background indicates the selected stream.
- **Throughput, Jitter,** and **Latency** meters display respectively the measured Throughput, Jitter, and Latency for the selected stream.

Note: *The green region is delimited from 0 to the Threshold corresponding to a **PASS** verdict. The red regions beyond the threshold corresponds to a **FAIL** verdict. The Pass/Fail verdict is only displayed when enabled (see QoS Metrics on page 321).*

- **Jitter:** See *Streams - Jitter* on page 464.
- **Latency:** See *Streams - Latency* on page 465.
- **RX Rate:** See *Streams - Throughput / Customer Frame Throughput* on page 466.
- **RX Frame Count** indicates the number of frame received matching the selected stream.
- **TX Rate:** See *Streams - Throughput / Customer Frame Throughput* on page 466.
- **TX Frame Count** indicates the number of transmitted frames matching the selected stream.
- **Frame Loss and Out-of-Sequence:** See *Streams - Frame Loss / Out-of-Sequence* on page 464.

Summary (Wander)

From the **Test** menu, tap **Results**, and the **Summary** tab.

- **Test Status** displays the current status of the Wander test. The global test pass/fail verdict is displayed next to the **Test Status** when enabled (see **Pass/Fail Verdict** on page 324).

Test Status	Description
--	The test is not running or results are not available.
In Progress	The test is running.
Completed	The test is completed, stopped at the planned time, or manually stopped when there is no set timer.
Aborted	Test has been aborted either manually (Stop) or automatically from an alarm.

- **Start Time** indicates the time the test was started.
- **Test Recovery**, when displayed, indicates that the test has automatically recovered from a power failure. The number of occurrences is also displayed next to the **Test Recovery** field. Refer to *Power Failure Recovery* on page 659.
- **Logger Full**, when displayed, indicates that the logger is full. Refer to *Logger* on page 432.

Test Results

Summary (Wander)

Time Error Statistics

Note: *The following statistics are collected using 0.1 Hz Low-Pass filtering. The following statistics are available with 1PPS signal.*

- **TE (ns)** indicates the last time error value collected in the last second.
- **Max TE (ns)** indicates the maximum time error value collected since the beginning of the test.
- **Min TE (ns)** indicates the minimum time error value collected since the beginning of the test.
- **Max Absolute TE (ns)** indicates the maximum absolute time error value collected since the beginning of the test. The pass/fail verdict is also displayed when enabled.

Note: *The following statistics are collected using 0.1 Hz High-Pass filtering.*

- **dTE_H pk-pk (ns)** indicates the dynamic time error peak-to-peak over a defined observation period (refer to **dTE_H Observation Period** on page 339). The values are updated every second.
- **Max dTE_H pk-pk (ns)** indicates maximum dynamic time error peak-to-peak since the beginning of the test. The pass/fail verdict is also displayed when enabled.

Note: *The following statistics are collected without any filtering.*

- **cTE (ns)** indicates the constant time error which is an average value of time error over the defined period as follows (refer to **cTE Averaging Period** on page 339):
 - since the beginning of the test when the **cTE Average Period** is set to **EIapse Time**.
 - for the averaging period defined when the **cTE Average Period** is set to a value other than the **EIapse Time**. The first value is only available after the initial average period has elapsed, the value is then updated every second.
- **Max cTE (ns)** indicates the maximum cTE value collected since the beginning of the test. The pass/fail verdict is also displayed when enabled.
- **MTIE** and **TDEV** pass/fail verdict icons are displayed when enabled.

Time Interval Error Statistics

The following statistics are not available with 1PPS rate.

- **TIE (ns)** is the Time Interval Error value collected in the last second.
- **Max TIE (ns)** is the Maximum Time Interval Error value collected since the beginning of the test.
- **Min TIE (ns)** is the Minimum Time Interval Error value collected since the beginning of the test.
- **Max TIE pk-pk (ns)** is the maximum Time Interval Error peak-to-peak since the beginning of the test.

Test Results

Summary (Wander)

Graph

Dynamically displays the graph of either TE or TIE values as a function of time. The dynamic view is a sliding window displaying the last 27000 samples collected.

Zooming the graph:

- Using the touch screen: Tap two points on the graph and drag them to enlarge the view.
- Using a mouse: click and drag the region to be zoomed.

Settings

- **Sampling Rate** indicates the sampling rate value.
- **TE/TIE Scale** allows the selection of the Y-axis scale: **Auto** (default), **800 μ s**, **200 μ s**, **2 μ s**, **400 ns**, **100 ns**.
- **Number of samples** indicates the number of samples collected since the beginning of the test.

Traces - OTN

From the **Test** menu, tap **Results**, **Traces**, and the **OTN** sub-tab.

Channel

Available with Multi-Channel OTN, allows the selection of the channel number.

OTU_x, ODU_x, ODU_k, and TCM Buttons

Tap on either OTU_x, or an ODU_x/ODU_k button. For ODU_x when TCM is enabled (see Modify TCM on page 306), tap on a TCM_x button to select a TCM level. TCM is not available with Multi-Channel OTN. For Multi-Channel, the ODU_k level displayed will be the one corresponding to the selected channel.

SM/PM TTI Traces

Received Message

- **SAPI** indicates the received TTI (Trail Trace Identifier) Source Access Point Identifier.
- **DAPI** indicates the received TTI Destination Access Point Identifier.
- **Operator Specific** indicates the received TTI Operator Identifier.

Expected Message

Note: *The TTI Traces are configurable for SM (OTU_x), PM (ODU_x), and TCM (ODU_x when TCM is enabled; refer to Modify TCM on page 306). The following settings are coupled with the Expected Message from Traces (OTN) on page 332.*

- **SAPI** allows editing the expected Source Access point Identifier (TTI bytes 0 to 15). Available when the SAPI OTU/ODU-TIM check box is selected.

Test Results

Traces - OTN

- **DAPI** allows editing the expected Destination Access point Identifier (TTI bytes 16 to 31). Available when the DAPI OTU/ODU-TIM check box is selected.
- **SAPI OTU/ODU-TIM** check box¹, when selected (cleared by default), allows editing the expected Source Access Point Identifier (SAPI) and also enables OTU/ODU-TIM alarm monitoring.
- **DAPI OTU/ODU-TIM** check box¹, when selected (cleared by default), allows editing the expected Destination Access Point Identifier (SAPI) and also enables the OTU/ODU/TCM-TIM alarm monitoring.
- **Copy RX/Global Copy RX**² uses the received SAPI/DAPI message as the expected SAPI/DAPI. For Multi-Channel OTN lower ODU layer, use the arrow button next to the **Copy RX** or **Global Copy RX** to switch from one button to the other; **Global Copy RX** uses the current channel received SAPI/DAPI message as the expected SAPI/DAPI for all channels while **Copy RX** only affects the selected channel.

1. For Multi-Channel OTN lower ODU layer, the SAPI and DAPI ODU-TIM check boxes are only configurable from the test setup.

2. Only available for Multi-Channel OTN lower ODU layer.

Traces - SONET/SDH

From the **Test** menu, tap **Results**, **Traces**, and the **SONET/SDH** sub-tab.

Note: *Selecting a Trace byte to be generated will automatically update the corresponding OH byte. Refer to OH - SONET/SDH on page 591 for more information.*

Traces

➤ **Section/RS (J0), and STS/AU/TU-3 Path (J1), and VT/TU Path (J2)**

Displays the received J0/J1/J2 value in 16 or 64-bytes format. The <crc7> represents the CRC-7 for a 16-bytes format. The last two bytes of a 64-bytes format, <C_R> and <L_F>, represent respectively a carriage return and a line feed.

➤ **TIM-S/RS-TIM, TIM-P/HP-TIM, TIM-V/LP-TIM:** Enables the corresponding Trace Identifier Mismatch for the expected message defined. These settings are coupled with the Traces configuration from *Traces (SONET/SDH)* on page 336.

Copy RX allows using the received TIM message as the expected one.

TCM Access Point Identifier

Note: *Available when TCM is enabled (refer to page 307).*

➤ **STS/AU Path (N1), and VT/TU Path (Z6 or N1 (TU-3))**

Displays the received N1/Z6 value.

➤ **TC-TIM-P/HPTC-TIM/TC-TIM-V/LPTC-TIM:** Enables the corresponding TCM Access Point Identifier for the expected message defined. These settings are coupled with the Traces configuration from *Traces (SONET/SDH)* on page 336.

Copy RX allows using the received TIM message as the expected one.

Test Results

Traffic - Ethernet

Traffic - Ethernet

From the **Test** menu, tap **Results**, **Traffic**, and when applicable the **Ethernet** tab.

Note: For Through Mode test application, the traffic statistics are displayed for both port directions (P1->P2 and P2->P1).

P1 and P2 Buttons

The **P1** and **P2** buttons, available with **Dual Port** topology, allow respectively displaying results for port #1 (**P1**) or port #2 (**P2**).

Traffic

- **Line Utilization (%)** indicates the current percentage of the transmitting/receiving line rate utilization.
- **Ethernet BW (Mbit/s)** indicates the current transmitting/receiving data rate expressed in Mbit/s.
- **Frame Rate (frame/s)** indicates the current transmitted/received number of frames (including bad frames, Broadcast frames and Multicast frames) in frame per second.
- **Frame Count** indicates the total number of transmitted/received valid and invalid frames.

Frame Type

Displays the TX and RX count of the following frame types.

- **Multicast** indicates the number of multicast frames transmitted/received without FCS errors. Broadcast frames are not counted as multicast frames.
- **Broadcast** indicates the number of broadcast frames transmitted/received without FCS errors.

- **Unicast** indicates the number of unicast frames transmitted/received without FCS errors.
- **Non-Unicast** indicates the number of multicast and broadcast frames transmitted/received without FCS errors.
- **Total** indicates the total number of all frames transmitted/received without FCS error.

Frame Size

Displays the RX count of each received frame size (valid and invalid), and the percentage (%) ratio of each received frame size based on the total count of frames. The percentage (%) ratio is not available for Through Mode test application.

- **< 64/80/82**: frames with less than 64 bytes; 80 bytes for EoE; 82 bytes for PBB-TE.
- **64/80/82**: frames equal to 64 bytes; 80 bytes for EoE; 82 bytes for PBB-TE.
- **65/81/83 - 127**: frames from 65 to 127 bytes; 81 to 127 bytes for EoE; 83 to 127 bytes for PBB-TE.
- **128 - 255**: frames from 128 to 255 bytes.
- **256 - 511**: frames from 256 to 511 bytes.
- **512 - 1023**: frames from 512 to 1023 bytes.
- **1024 - 1518/1534/1536**:
 - **1024 - 1518**: frames from 1024 to 1518 (no VLAN), 1522 (1 VLAN tag), 1526 (2 VLAN tags), or 1530 (3 VLAN tags) bytes.
 - **1024 - 1534**: for EoE, frames from 1024 to 1534; add 4 bytes to 1534 for each VLAN layer enabled in the encapsulated Ethernet payload and 4 bytes for EoE VLAN when enabled.

Test Results

Traffic - Ethernet

- **1024 - 1536:** for PBB-TE, frames from 1024 to 1536; add 4 bytes to 1536 for each VLAN layer enabled in the encapsulated Ethernet payload and 4 bytes for B-VLAN when enabled.
- **> 1518/1534/1536:**
 - **> 1518:** frames with more than 1518 (no VLAN), 1522 (1 VLAN tag), 1526 (2 VLAN tags), or 1530 (3 VLAN tags) bytes.
 - **> 1534:** for EoE: frame with more than 1534; add 4 bytes to 1534 for each VLAN layer enabled in the encapsulated Ethernet payload and 4 bytes for EoE VLAN when enabled.
 - **> 1536:** for PBB-TE, frame with more than 1536; add 4 bytes to 1536 for each VLAN layer enabled in the encapsulated Ethernet payload and 4 bytes for B-VLAN when enabled.
- **Total** indicates the total count of all received frames (valid and invalid).

Traffic - Flow Control

From the **Test** menu, tap **Results**, **Traffic**, and the **Flow Control** tab.

P1 and P2 Buttons

The **P1** and **P2** buttons, available with **Dual Port** topology, allow respectively displaying results for port #1 (**P1**) or port #2 (**P2**).

Frame Count - RX

- **Pause Frames** indicates the number of received valid flow-control frames. Frames that have a type/length field equal to 0x8808 will be counted as a pause frame.
- **Abort Frame** indicates the number of received pause frames with a Quanta equal to zero; cancelling the pause frames.
- **Total Frame** indicates the total number of pause time received from the link partner.

Pause Time

Indicates respectively the total, last, maximum, and minimum pause time received from the link partner in **Quanta** (default) or **Microsecond** (μs).

Test Results

Traffic - Flow Control

Pause Injection

Note: *Pause injection is only available for Traffic Gen & Mon test application.*

- **Packet Pause Time:** Enter the pause time value to be transmitted in **Quanta** or **Microsecond** (default is **100 Quanta**).

Interface	Range	
	Quanta	μ s
10 Mbit/s	0 to 65535	0 to 3355392
100 Mbit/s	0 to 65535	0 to 335539.2
1000 Mbit/s	0 to 65535	0 to 33553.92
10 Gbit/s	0 to 65535	0 to 3355.392
40 Gbit/s	0 to 65535	0 to 838.848
100 Gbit/s	0 to 65535	0 to 335.5392

Note: *When entering a value in μ s it will be rounded to the closest multiple of 0.0512 for 10 Gbit/s, 5.12 μ s for 100 Mbit/s, 0.512 μ s for 1000 Mbit/s, 0.0512 μ s for 10 Mbit/s, 0.0128 for 40 Gbit/s, and 0.00512 for 100 Gbit/s.*

- **Inject** button allows generating the defined packet pause time.
- **Destination MAC Address** check box, when selected (cleared by default), enables and allows setting the destination MAC address. The default destination MAC address is the control protocol multicast address: **01:80:C2:00:00:01**.

Traffic - Graph

From the **Test** menu, tap **Results**, **Traffic**, and the **Graph** tab.

P1 and P2 Buttons

The **P1** and **P2** buttons, available with **Dual Port** topology, allow respectively displaying results for port #1 (**P1**) or port #2 (**P2**).

The graph displays the received line utilization. The X axis shows the time in seconds while the Y axis shows the percentage utilization.

Test Results

Traffic - OAM, S-OAM, and MPLS-TP OAM

Traffic - OAM, S-OAM, and MPLS-TP OAM

From the **Test** menu, tap **Results**, **Traffic**, and the **OAM, S-OAM**, or **MPLS-TP OAM** tab.

Traffic Monitoring

Note: Only available with *Carrier Ethernet OAM* test application.

- In TX, reports counts of CCM, LBM, LTM, DMM, LMM, SLM, TST, AIS, LCK, and CSF frames transmitted. LTM and SLM are only available with Ethernet OAM. Total count is reported as well as unicast and/or multicast frame counts when applicable.
- In RX, reports counts of CCM, LBR, LTR, DMR, LMR, SLR, TST AIS, LCK, and CSF frames (LTR and SLR are only available with Ethernet OAM) received regardless of the sender as long as the following criteria are met:
 - **S-OAM:** The destination MAC address matches either the local MEP Unicast MAC address or a Multicast class 1 or class 2 address; and the VLANs matches the unit port VLANs. Refer to *Unicast/Multicast Addresses for Ethernet OAM* on page 757 for more information.
 - **MPLS-TP OAM:** The destination MAC address matches either the unit MAC address, FF:FF:FF:FF:FF:FF, or 01:00:5E:90:00:00; the VLANs matches the unit port VLANs; and MPL Labels matches the local MPLS Label Stack configuration. For AIS, LCK, and CSF, valid messages must also have the MEG Level matching the Local MEG Level.

Total count is reported as well as unicast and/or multicast frame counts when applicable.

Responder

Note: Available when the **S-OAM Responder** or **MPLS-TP OAM Responder** check box is selected (refer to S-OAM and MPLS-TP OAM Responder on page 268).

For **Carrier Ethernet OAM** test application:

- In TX, reports counts of LBR, LTR, DMR, LMR, and SLR total frames transmitted. LTR and SLR are only available with Ethernet OAM.
- In RX, reports counts of valid LBM, LTM, DMM, LMM, and SLM unicast, multicast, and total frames received. LTM and SLM are only available with Ethernet OAM. A valid messages must have its:

S-OAM: source MAC address matching the Peer MEP MAC address; destination MAC address matching either the unit port Unicast MAC address or a Multicast class 1 or class 2 address; VLANs matching the unit port VLANs, and MEG/MD Level matching the local MEG/MD Level. Refer to *Unicast/Multicast Addresses for Ethernet OAM* on page 757 for more information.

MPLS-TP OAM: destination MAC address matching either the unit MAC address, FF:FF:FF:FF:FF:FF, or 01:00:5E:90:00:00; VLANs matching the unit port VLANs; and MPL Labels matching the local MPLS Label Stack configuration.

For **Smart Loopback** test application:

- In TX, reports counts of LBR, LTR, DMR, LMR, and SLR total frames transmitted.
- In RX, reports counts of valid LBM, LTM, DMM, LMM, and SLM total frames received. A valid messages must have its destination MAC address matching either the unit port Unicast MAC address or a Multicast class 1 or class 2 address. Refer to *Unicast/Multicast Addresses for Ethernet OAM* on page 757 for more information.

Test Results

Window Sweep

Window Sweep

Displays the graph showing the Ideal L4 and Actual L TCP Throughput measured for each Window Sweep step. The number of connections and KiB per connection is also displayed in parenthesis as follows:
(n conn.@ n KiB)

From the **Test** menu, tap **Results**, and the **Window Sweep** tab.

WIS

From the **Test** menu, tap **Results**, and the **WIS** tab.

Traces/Label

- **J0 Trace** displays the **J0 Trace** value in 16-bytes format.
- **J1 Trace** displays the **J1 Trace** value in 16-bytes format.
- **Path Signal Label (C2)** displays the content of the STS SPE including the status of the mapped payload.

10 Test Functions

The Test Functions menu offers the following structure:

Transport Test Applications

Tab - Sub Tab	Available with							Page
	OTN BERT	Multi-Channel OTN	OTN-SONET/SDH BERT	SONET/SDH BERT	DSn/PDH BERT	SONET/SDH - DSn/PDH BERT	NI/CSU Emulation	
40/100G Advanced - CFP4/QSFP Control	X	X	X	-	-	-	-	542
40/100G Advanced - Lanes Mapping & Skew	X	-	X	-	-	-	-	545
APS	-	-	X	X	-	X	-	550
Client Offset	X	-	-	-	-	-	-	553
FDL - Bit-Oriented Message	-	-	-	-	X	-	X	556
FDL - Performance Report Message	-	-	-	-	X	-	X	560
FEAC	-	-	-	-	X	-	-	563
GCC BERT	X	-	X	-	-	-	-	577
GMP	X	X	X	-	-	-	-	579
OH (GFP-F/GFP-T)	X	-	-	-	-	-	-	580
OH (OTN)	X	-	X	-	-	-	-	585
OH (SONET/SDH)	-	-	X	X ^a	-	X	-	591
Pointer Adjustment	-	-	X	X	-	X	-	610
RTD	X	-	X	X	X	X	-	620
Signaling Bits	-	-	-	-	X	X	-	628
Spare Bits	-	-	-	-	X	X	-	630

a. The sub tab is not displayed.

Test Functions

Ethernet Test Applications

Tab - Sub Tab	Test Application										Page
	a	b	c	d	e	f	g	h	i	j	
40/100G Advanced - CFP4/QSFP Control	X	X	X	X	X	X	-	-	-	-	542
40/100G Advanced - Lanes Mapping & Skew	X	X	X	X	X	X	-	-	-	-	545
Filters	-	-	-	X	X	-	X	-	X	-	567
Packet Capture	-	-	-	X	X	-	X	-	X	-	571
Ping & Trace Route	X	X	X	X	X	X		X	X	X	605
S-OAM Link Trace	-	-	-	-	-	-	-	-	X	-	626
Traffic Scan	-	-	-	-	X	-	-	-	-	-	632

- a. EtherSAM
- b. RFC 6349
- c. RFC 2544
- d. EtherBERT
- e. Traffic Gen & Mon
- f. Smart Loopback
- g. Through Mode
- h. TCP Throughput
- i. Carrier Ethernet OAM
- j. Cable Test

Sync Test Applications

Tab	Test Application		Page
	1588 PTP	SyncE	
Filters	X	X	567
Packet Capture	X	X	571
Ping & Trace Route	X	X	605

Wireless Test Application

Tab	Framing	Test Application		Page
		CPRI/OBSAI BERT CPRI	OBSAI	
RTD	Unframed	X	X	620
	Framed L2	X	-	623
RTT	Framed L2	-	X	623

Test Functions

40/100G/400G Advanced - CFP4/CFP8/QSFP Control

40/100G/400G Advanced - CFP4/CFP8/QSFP Control

From the **Test** menu, tap **Functions**, **40/100G/400G Advanced**, and the **CFP4/CFP8/QSFP Control** tab.

CFP4/CFP8 Reference Clock (MHz)

Allows selecting the reference clock that will be used by the transceiver.

Interface/Rate	1/160 Host Lane Rate (default - recommended)	1/40 Host Lane Rate
OTU4	174.7031 MHz	698.8123 MHz
100GE	161.1328 MHz	644.5313 MHz
400GE	156.25 MHz	625.0 MHz

CFP4/CFP8/QSFP Power Class

Indicates the power class of the inserted transceiver module.

CFP4/CFP8/QSFP Control Pins

Allows the following transceiver control pin settings. Refer to the CFP MSA standard for more information.

Note: *To apply any control, first select its check box then clear it; the control is applied only when the selected check box is cleared.*

- **TX Disable**¹ check box (cleared by default).
- **Module Low Power Mode** check box (cleared by default).
- **Module Reset** check box (cleared by default).
- **Module Power Shutdown** check box (cleared by default).

CFP4/CFP8/QSFP Status Pins

Gives the following transceiver’s pin status (refer to the CFP/QSFP MSA standard for more information):

Transceiver	Pin status
CFP4 CFP8	Module Absent, RX Loss of Signal, Global Alarm
QSFP	Module Absent

1. Not supported with QSFP.

Test Functions

40/100G/400G Advanced - CFP4/CFP8/QSFP Control

CFP4/CFP8/QSFP MDIO/I2C Access Interface

➤ MDIO/I2C - Bulk Read

- **Page Select**, available for QSFP I2C, allows selecting the I2C address page: **0x00** (default) to **0xFF**.
- **MDIO/I2C Start Address** allows selecting the MDIO/I2C start address: **0x0000** (default) to **0xFFFF** (MDIO)/**0x00FF** (I2C).
- **MDIO/I2C End Address** allows selecting the MDIO/I2C end address: **0x0000** to **0xFFFF**; default is **0x00FF**.
- **Bulk Read** button reads and displays the data based on the specified MDIO range (MDIO/I2C Start Address to MDIO/I2C End Address).

Save to CSV button allows saving the read MDIO/I2C's addresses and data to a CSV file.

Note: *The bulk read size is limited to 1024 addresses.*

➤ MDIO/I2C - Read/Write

- **MDIO/I2C Address** allows selecting the MDIO/I2C address: **0x0000** (default) to **0xFFFF** (MDIO)/**0x00FF** (I2C).
- **MDIO/I2C Data** allows either selecting (write) or reading the MDIO/I2C data: **0x0000** (default) to **0xFFFF** (MDIO)/**0x00FF** (I2C).

Read button reads the data of the specified **MDIO/I2C Address**.

Write button writes the specified **MDIO/I2C DATA** value to the specified **MDIO/I2C Address**.

CFP4/CFP8 TX Status

Indicates the transceiver transmission status for each optical lane.

40/100G/400G Advanced - Lanes Mapping & Skew

Note: Only available with parallel interfaces. Not available when the **RS-FEC** check box is selected.

From the **Test** menu, tap **Functions**, **40/100G/400G Advanced**, and the **Lanes Mapping & Skew** tab.

TX

- **PCS/Logical Lane**, for Ethernet test applications, indicates the PCS (Ethernet test applications) or Logical (Transport Test applications) lane markers. To change the PCS/Logical lane order, see *Default/Random/Manual Mapping* on page 547.
- **Skew (Bits)** indicates the TX relative delay in bit time for each PCS/Logical lane. To change the skew values, see *Reset/Manual Skew* on page 548.

400GAUI-16 Lane

Indicates the 400GAUI-16 Lane numbers. Not available with CFP4 and QSFP.

RX

- **Skew (bits)** indicates the delay in bit time between the earliest PCS/Logical lane and the current lane for the one to zero transition of the alignment marker sync bits. The received skew accuracy is ± 100 bits.
- **PCS/Logical Lane** indicates received PCS/Logical Lane markers.

Note: If a PCS/Logical Lane marker is detected more than once, a red background is used to highlight all occurrences of this PCS/Logical Lane marker. **Duplicate** is also displayed on a red background.

Test Functions

40/100G/400G Advanced - Lanes Mapping & Skew

PCS/Logical Lane

Allows ordering the PCS/Logical Lane markers in either **Ascending** (1,2,3...) or **Coupled to RX**.

Alarms

For a description of each alarm, refer to *OTL* on page 385 for Transport and *Ethernet - PCS Lanes* on page 364 for Ethernet.

Errors

For a description of each error, refer to *OTL* on page 385 for Transport and *Ethernet - PCS Lanes* on page 364 for Ethernet.

The error values are displayed in seconds by default. Tapping on the unit allows selecting either **Seconds**, **Count**, or **Rate**.

Total indicates the total of all lanes when **Count** or **Rate** unit is selected.

Default/Random/Manual Mapping

Allows changing the PCS/Logical lane mapping that will be used for the test. Not available with 100 GbE client in OTU4.

- **Default Mapping** sets the TX mapping to the default numerical order value which corresponds to the ascending PCS/Logical lane order.
- **Random Mapping** sets the TX mapping in a random order. Each time the button is tapped, random alignment markers are assigned to each PCS/Logical lane.
- **Manual Mapping** allows setting the TX mapping manually.
 - **PCS/Logical Lane/Lane Marker and Assigned Status:**
The **PCS/Logical Lane/Lane Marker** buttons allow assigning the corresponding Lane Marker to the selected PCS/Logical or 400GAUI-16/CAUI/XLAUI/Physical Lane mapping (the one pointed by the arrow). The **Assigned Status** column displays a check mark next to the assigned PCS/Logical Lanes. Range is from **0** to **15** for 400G, **0** to **19** for OTU4/100G, and **0** to **3** for OTU3/OTU3e1/OTU3e2/40G.
 - **PCS/Logical Lane and 400GAUI-16/CAUI/XLAUI/Physical Lane** columns indicate the target PCS/Logical to 400GAUI-16/CAUI/XLAUI/Physical mapping.
 - **Clear All** clears the PCS/Logical to 400GAUI-16/CAUI/XLAUI/Physical Lane assignments.
 - **OK** accepts the new PCS/Logical to 400GAUI-16/CAUI/XLAUI/Physical lane mapping. All target PCS/Logical Lane fields must contain an assignment, including duplicates, to give access to the **OK** button.

Note: *A PCS/Logical Lane marker can be assigned more than once. If this is the case, a red background is used to highlight all occurrences of this PCS/Logical Lane marker.*

Test Functions

40/100G/400G Advanced - Lanes Mapping & Skew

Reset/Manual Skew

Allows the selection of a relative delay in bit time that will be introduced for each PCS/Logical lane. Not available with 100 GbE client in OTU4.

- **Reset Skew** sets all TX skew (bit time) values to 0.
- **Manual Skew** allows setting the skew value for each PCS/Logical lane manually.
 - **All Lanes**, when selected, applies the change(s) to all PCS/Logical Lane at once.
 - **Skew Inc/Dec Size (bits)** allows setting the increment/decrement value that will be used when changing the TX Skew (bits) values using the “+” and “-” buttons. Range is from **0** to **10550** for 400G, **0** to **2047** for 100G/OTU4 and **0** to **4095** for 40G/OTU3/OTU3e1/OTU3e2.
 - **PCS/Logical Lane** indicates the PCS/Logical Lane numbers and **All** which represents the value for all PCS/Logical Lane when the **All Lanes** check box is selected.
 - **Skew (bits)** allows setting the skew value for each lane. Enter directly the skew value in the field or use the “+” and “-” buttons to respectively increment or decrement the skew value using the defined **Skew Inc/Dec Size** value. Tapping and holding the “+” or “-” button allows reaching the desired value faster using the defined **Skew Inc/Dec Size** value. Range is from **0** to **10550** for 400G, **0** to **2047** for 100G/OTU4 and **0** to **4095** for 40G/OTU3/OTU3e1/OTU3e2.

Laser ON/OFF

Allows activating the laser control per optical lane or for all lanes.

Optical lane numbers are from **0** to **3** or **0** to **7** depending on the selected interface/rate.

- **All Lanes** check box, when selected, applies the change(s) to all optical lanes at once.
- **Optical Lane** indicates the optical lane numbers and **All** which represents the setting for all optical lanes when the **All Lanes** check box is selected.
- **Laser** check box, when selected, indicates that the corresponding optical laser lane is activated and emitting an optical laser signal.

Skew Alarm Threshold (bits)

Allows setting the threshold value that will be used to declare a skew alarm (see **Ex. Skew** on page 385).

Default button restores the default alarm threshold value.

Test Functions

APS

APS

From the **Test** menu, tap **Functions**, and the **APS** tab.

TX/RX

- **Switching Mode**, available for both TX and RX, selects the switching mode: **Linear** (default) or **Ring**.
- **K1**

Request: Bits 1 through 4 of the K1 byte.

Bits 1 to 4	Request	
	Linear mode	Ring mode
0000	No Request ^a	No Request (default) ^a
0001	Do Not Revert	Reverse Request - Ring
0010	Reverse Request	Reverse Request - Span
0011	Unused	Exerciser - Ring
0100	Exerciser	Exerciser - Span
0101	Unused	Wait-to-Restore
0110	Wait-to-Restore	Manual Switch - Ring
0111	Unused	Manual Switch - Span
1000	Manual Switch	Signal Degrade - Ring
1001	Unused	Signal Degrade - Span
1010	Signal Degrade - Low Priority	Signal Degrade (Protection)
1011	Signal Degrade - High Priority	Signal Fail - Ring
1100	Signal Fail - Low Priority	Signal Fail - Span
1101	Signal Fail - High Priority	Force Switch - Ring
1110	Force Switch	Force Switch -Span
1111	Lockout of Protection	Lockout of Protection - Span/SF - P

a. Default value.

**Channel (Linear switching mode) or
Destination Node ID (Ring switching mode):**
Bits 5 through 8 of the K1 byte.

Bits 5 to 8	Channel ID (Linear mode)	Destination Node ID (Ring mode)	Bits 5 to 8	Channel ID (Linear mode)	Destination Node ID (Ring mode)
0000	0 - Null ^a	0 ^a	1000	8	8
0001	1	1	1001	9	9
0010	2	2	1010	10	10
0011	3	3	1011	11	11
0100	4	4	1100	12	12
0101	5	5	1101	13	13
0110	6	6	1110	14	14
0111	7	7	1111	15 - Extra Traffic	15

a. Default value.

➤ K2

**Protected Channel (Linear switching mode) or
Source Node ID (Ring switching mode):**
Bits 1 through 4 of the K2 byte.

Bits 1 to 4	Protected Channel (Linear mode)	Source Node ID (Ring mode)	Bits 1 to 4	Protected Channel (Linear mode)	Source Node ID (Ring mode)
0000	0 - Null ^a	0 ^a	1000	8	8
0001	1	1	1001	9	9
0010	2	2	1010	10	10
0011	3	3	1011	11	11
0100	4	4	1100	12	12
0101	5	5	1101	13	13
0110	6	6	1110	14	14
0111	7	7	1111	15 - Extra Traffic	15

a. Default value.

Test Functions

APS

Architecture (Linear switching mode) or Bridge Request (Ring switching mode):
Bit 5 of the K2 byte. The default setting is **1+1** for Linear switching mode and **Short Path Request** for Ring switching mode.

Bit 5	Architecture (Linear mode)	Bridge Request (Ring mode)
0	1+1 ^a	Short Path ^a
1	1:n	Long Path

a. Default value.

Operation Mode: Bits 6 through 8 of the K2 byte.

Bits 6 to 8	Linear mode	Ring mode
000	Reserved ^a	Idle ^a
001	Reserved	Bridged
010	Reserved	Bridged and Switched
011	Reserved	Extra Traffic - Protection
100	Unidirectional	Reserved
101	Bidirectional	Reserved
110	RDI-L ^b /MS-RDI ^c	RDI-L ^b /MS-RDI ^c
111	AIS-L ^b /MS-AIS ^c	AIS-L ^b /MS-AIS ^c

- a. Default value.
- b. Operation mode for SONET.
- c. Operation mode for SDH.

Client Offset

Note: Available with OTN BERT test application with **1GbE** client and **Pattern** client with **ODUflex** multiplexing.

From the **Test** menu, tap **Functions**, and the **Client Offset** tab.

TX Frequency

Note: TX Frequency is not available in **Through / Through Intrusive** topology.

- **Frequency (GHz)** indicates the frequency (nominal frequency + port frequency offset + client frequency offset) used for transmission.
- **Offset (ppm)** check box, when selected (cleared by default), allows setting the client frequency offset that will be generated. Use the “+” or “-” button to respectively increment or decrement the client frequency offset value based on the defined **Increment/Decrement Size**, or directly type the frequency offset value in the field.
- **Increment/Decrement Size (ppm)** allows setting the increment/decrement value (from 0.1 to either 115) that will be used when changing the frequency offset using the “+” or “-” button.

Client	Nominal Frequency	Offset ^a
1GbE	1250000000 bps	± 115 ppm
Pattern in ODUflex	Nominal bit rate configured (refer to <i>Nominal Bit Rate</i> on page 306).	± 115 ppm ^b

- a. The Client frequency offset range is guaranteed for a clock source signal at 0 ppm offset. In the event that the clock source signal already has an offset, the output signal may exhibit an offset larger than the range specified. For example, if the clock source signal has an offset of +20 ppm (configured on the Signal interface), the Client frequency offset could be up to 135 ppm (115 ppm + 20 ppm).
- b. The Client offset function does not allow the generation of a signal with a rate above 100 % of the TX rate. For example, if the TX Rate is set to 100 %, the allowed offset range will be -115 ppm to 0 ppm.

Test Functions

Client Offset

RX Frequency

- **Frequency (GHz)** indicates the frequency of the input signal.

Client	Measurement range
1GbE	1250000000 ±120 ppm
Pattern in ODUflex	Expected Frequency ±120 ppm (see page 555)

- **Offset (ppm)** indicates the frequency offset between the standard rate specification and the rate at the input signal.

Note: For both **Frequency** and **Offset** a background color is used to indicate if the received client signal rate meets the standard rate specifications. Not available with Pattern in ODUflex when the **Frequency Offset Analysis** check box is cleared.

Background color	Description
Green	The frequency is in range.
Red	The frequency is out-of-range or there is a LOC Lane condition. LOC is also displayed.
Gray	Pending state.

Client	Standard Rate Specification
1GbE	1250000000 ±12500 bps (±100 ppm)
Pattern in ODUflex	Expected Frequency ±100 ppm (see page 555)

- **Max. Negative Offset (ppm)** indicates the maximum negative frequency offset between the standard rate specification and the rate from the received signal.

- **Max. Positive Offset (ppm)** indicates the maximum positive frequency offset between the standard rate specification and the rate from the received signal.

Note: *The following parameters are only available with ODUflex mapped to pattern.*

- **Frequency Offset Analysis** check box, when selected, enables the frequency offset measurements. This setting is enabled by default for **Coupled** topology, and disabled for **Through / Through Intrusive** topology.
- **Expected Frequency (GHz)** is available when the **Frequency Offset Analysis** check box is selected.

For **Coupled** topology, the frequency is set to the configured **TX Rate** (refer to page 139).

For **Through / Through Intrusive** topology, enter the expected frequency in GHz.

Test Functions

FDL - Bit-Oriented Message

FDL - Bit-Oriented Message

Allows setting and configuring the Bit-Oriented Messages (BOM) of the Extended Super-Frame (ESF).

Note: *FDL is only available for DS1 interface with ESF framing. For Dual RX test, FDL is only available for the DS1 TX/RX port 1.*

From the **Test** menu, tap **Functions**, **FDL**, and the **Bit-Oriented Message** tab.

Generated Messages

► Priority

Codeword: The Bit-Oriented Message codewords are priority messages sent over the Data-Link. These messages are mostly used for networking operation and maintenance. A Bit-Oriented Message consists of 8 consecutive ones followed by a byte starting and ending by zeros.

Codeword	Pattern
RAI	00000000 11111111
Loopback Retention and Acknowledge	00101010 11111111
RAI-CI	00111110 11111111

Injects generates the selected codeword priority message.

► Command/Response

Amount allows the selection of the number of message to be generated. Choices are **1** to **15**. The default value is **10**.

Inject manually generates the selected amount of messages.

Codeword

Command/Response Codeword	Pattern	Command/Response Codeword	Pattern
Line Loopback Activate	00001110 11111111	Protection Switch Line 22	01101100 11111111
Line Loopback Deactivate	00111000 11111111	Protection Switch Line 23	01101110 11111111
Payload Loopback Activate	00010100 11111111	Protection Switch Line 24	01110000 11111111
Payload Loopback Deactivate	00110010 11111111	Protection Switch Line 25	01110010 11111111
Reserved for Network Use	00010010 11111111 ^a	Protection Switch Line 26	01110100 11111111
Universal Loopback (Deactivate)	00100100 11111111	Protection Switch Line 27	01110110 11111111
ISDN Line Loopback (NT2)	00101110 11111111	Protection Switch Acknowledge	00011000 11111111
CI/CSU Line Loopback (NT1)	00100000 11111111	Protection Switch Release	00100110 11111111
For network use	00011100 11111111 ^b	Do Not use for Synchronization	00110000 11111111
Protection Switch Line 1 b	01000010 11111111	Stratum 2 Traceable	00001100 11111111
Protection Switch Line 2	01000100 11111111	SONET Minimum Clock Traceable	00100010 11111111
Protection Switch Line 3	01000110 11111111	Stratum 4 Traceable	00101000 11111111
Protection Switch Line 4	01001000 11111111	Stratum 1 Traceable	00000100 11111111
Protection Switch Line 5	01001010 11111111	Synchronization Traceability Unknown	00001000 11111111
Protection Switch Line 6	01001100 11111111	Stratum 3 Traceable	00010000 11111111
Protection Switch Line 7	01001110 11111111	Reserved for Network Synchronization	01000000 11111111
Protection Switch Line 8	01010000 11111111	Transmit Node Clock (TNC)	01111000 11111111
Protection Switch Line 9	01010010 11111111	Stratum 3E Traceable	01111100 11111111
Protection Switch Line 10	01010100 11111111	Under study for maintenance	00101100 11111111
Protection Switch Line 11	01010110 11111111	Under study for maintenance	00110100 11111111
Protection Switch Line 12	01011000 11111111	Reserved for network use	00010110 11111111
Protection Switch Line 13	01011010 11111111	Reserved for network use	00011010 11111111
Protection Switch Line 14	01011100 11111111	Reserved for network use	00011110 11111111
Protection Switch Line 15	01011110 11111111	Reserved for network use	00111010 11111111
Protection Switch Line 16	01100000 11111111	Reserved for customer	00000110 11111111
Protection Switch Line 17	01100010 11111111	Reserved for customer	00001010 11111111
Protection Switch Line 18	01100100 11111111	Reserved for customer	00000010 11111111
Protection Switch Line 19	01100110 11111111	Reserved for customer	00110110 11111111
Protection Switch Line 20	01101000 11111111	Reserved for customer	00111100 11111111
Protection Switch Line 21	01101010 11111111	Reserved for customer	01111010 11111111

- a. Loopback Activate.
b. Indication of NT1 power off.

Receive Messages

- **Link Activity** indicates the activity of the following parameters during the last second of measurement.
 - **Idle** indicates that only idle codes have been detected in the last second.
 - **Priority** indicates that at least one valid priority message has been detected in the last second.
 - **C/R (Command/Response)** indicates that a least one valid command and response has been detected in the last second.
 - **Unassigned** indicates that at least one unassigned message has been detected in the last second. Therefore, since an unassigned message is part of a Command/Response codewords, the Command/Response LED will also be red.
 - **PRM** indicates that at least one PRM has been detected in the last second.
- **Priority:** The Bit-Oriented Messages are priority messages send over the Data-Link. These messages are mostly used for networking operation and maintenance. A Bit-Oriented Message consists of 8 consecutive 1s followed by a byte starting and ending by zeros.

Current indicates the priority message detected in the last second. If no priority message has been detected, "--" is displayed.

Previous indicates the last priority message detected excluding the current message. If no priority message has been detected since the beginning of the test, "--" is displayed.

Note: See Priority on page 556 for the list of possible priority codeword messages.

➤ **Command/Response**

Current indicates the command/response message detected in the last second. If no priority message has been detected, "--" is displayed.

Previous indicates the last command/response message detected excluding the current message. If no command/response message has been detected since the beginning of the test, "--" is displayed.

Note: *See Command/Response on page 556 for the list of possible Command/Response codeword messages.*

Test Functions

FDL - Performance Report Message

FDL - Performance Report Message

Note: FDL PRM is only available for DS1 interface with ESF framing. For Dual RX test, FDL is only available for the DS1 TX/RX port 1. For NI/CSU Emulation, only available in the RX direction.

From the **Test** menu, tap **Results**, tap the **FDL**, and **Performance Report Message** tab.

Generated Messages

- **Circuit** allows the selection of the circuit type: **CI to Network** (default) or **Network to CI**.
- **ANSI T1-403** check box when selected allows the generation of a compliant ANSI T1.403 PRM Message.
- **Injection**
 - Single** sends the selected PRM Message(s) manually.
 - Continuous** generates the selected PRM Message(s) continuously.
- **Event Count** indicates the number of PRM messages sent.
- **PRM Bit Events** allows the activation of the following PRM bit events. All PRM bit events are disabled by default.

G1: CRC = 1	FE: Frame sync. bit error ≥ 1
G2: $1 < \text{CRC} \leq 5$	LV: Line code violation event ≥ 1
G3: $5 < \text{CRC} \leq 10$	LB: Payload loopback activated
G4: $10 < \text{CRC} \leq 100$	SL: Slip ≥ 1
G5: $100 < \text{CRC} \leq 319$	R Bit (Reserved - Default value is 0)
G6: CRC ≥ 320	U1: Bit
SE: Severely errored framing ≥ 1	U2: Bit

Received Messages

- **Event Counts** lists received PRM bit event counts. See **PRM Bit Events** below.
- **Report Content** lists received performance information. See **Performance Information** below.
- **Circuit** indicates the selected circuit type: **CI to Network** or **Network to CI**.
- **Valid Event Count** indicates the number of valid PRM messages received.
- **Link Activity**, see page 558 for more information.
- **PRM Bit Events** table, available when the **Event Counts** button is selected, reports the count of the detected valid PRM bit events.

G1: CRC = 1	SE: Severely errored framing ≥ 1
G2: $1 < \text{CRC} \leq 5$	FE: Frame sync. bit error ≥ 1
G3: $5 < \text{CRC} \leq 10$	LV: Line Code Violation ≥ 1
G4: $10 < \text{CRC} \leq 100$	LB: Payload loopback activated
G5: $100 < \text{CRC} \leq 319$	SL: Slip ≥ 1
G6: CRC ≥ 320	

Test Functions

FDL - Performance Report Message

- ▶ **Performance Information** table, available when the **Report Content** button is selected, reports the time t0, t0-1, t0-2, and t0-3 for each PRM.

Time

- ▶ **T0** represents the valid PRM message received in the last second of measurement (bytes 5 and 6).
- ▶ **T0-1** represents the message one PRM ago (bytes 7 and 8).
- ▶ **T0-2** represents the message two PRM ago (bytes 9 and 10).
- ▶ **T0-3** represents the message three PRM ago (bytes 11 and 12).

PRM

G3: $5 < \text{CRC Error Event} \leq 10$

LV: Line Code Violation Event ≥ 1

G4: $10 < \text{CRC Error Event} \leq 100$

U1: Under study for synchronization

U2: Under study for synchronization

G5: $100 < \text{CRC Error Event} \leq 319$

SL: Controlled Slip Event ≥ 1

G6: CRC Error Event ≥ 320

FE: Frame Sync. Bit Error Event ≥ 1

SE: Severely-Errored Framing Event ≥ 1

LB: Payload Loopback Activated

G1: CRC Error Event = 1

R: Reserved

G2: $1 < \text{CRC Error Event} \leq 5$

Nm and **NI:** One-second report modulo 4 counter.

FEAC

The Far-End Alarm and Control signal (FEAC) provides Communication Channel capability over a DS3 in a network applications using C-bit Parity configuration (see page 294).

From the test menu, tap **Functions**, and the **FEAC** tab.

Generated Messages

Allows configuring and sending alarms/status information and control signals (loopback commands) to other network elements.

► Alarm/Status and Unassigned

- **Codeword** allows the selection of the codeword alarm/status to be generated either manually or continuously.

The FEAC message format is a 16 bit codeword (0xxxxxx0 1111111) with the rightmost bit transmitted first. The 0xxxxxx0 represents the message codeword.

Codeword		
DS3 Equipment Failure SA (00110010)	Single DS1 LOS (00111100)	User Defined (00100000)
DS3 Loss of Signal (LOS) (00011100)	DS1 Equipment Failure NSA (00000110)	User Defined (00100010)
DS3 Out-of-Frame (00000000)	User Defined (00000010)	User Defined (00101000)
DS3 AIS Received (00101100)	User Defined (00000100)	User Defined (00101110)
DS3 Idle Signal Received (00110100)	User Defined (00001000)	User Defined (00110000)
DS3 Equipment Failure NSA (00011110)	User Defined (00001100)	User Defined (00111110)
DS3 NUI Loop Up (00010010)	User Defined (00010000)	User Defined (01000000)
DS3 NUI Loop Down (00100100)	User Defined (00010100)	User Defined (01111010)
Common Equipment Failure NSA (00111010)	User Defined (00010110)	User Defined (01111100)
Multiple DS1 LOS (00101010)	User Defined (00011000)	User Defined (01111110)
DS1 Equipment Failure SA (00001010)	User Defined (00011010)	

- **Mode** is the alarm/status injection mode: **Manual** or **Continuous**.

Test Functions

FEAC

- **Amount** is the amount of codeword to be generated: **1 to15** (default is **10**).
- **Inject** generates error(s) according to the Codeword and mode selected.
- **Loopback Commands**
 - **Control**

Codeword is the loopback control codeword to be generated: **Line Loopback Activate (00001110)** - (Default) or **Line Loopback Deactivate (00111000)**.

Amount is the number of **Control Codeword** to be generated: **1 to 15** (default is **10**).
 - **Channel**

Codeword is the channel codeword to be generated.

Channel Codeword		
DS3 Line (00110110)	DS1 Line-No10 (01010100)	DS1 Line-No20 (01101000)
DS1 Line-No1 (01000010)	DS1 Line-No11 (01010110)	DS1 Line-No21 (01101010)
DS1 Line-No2 (01000100)	DS1 Line-No12 (01011000)	DS1 Line-No22 (01101100)
DS1 Line-No3 (01000110)	DS1 Line-No13 (01011010)	DS1 Line-No23 (01101110)
DS1 Line-No4 (01001000)	DS1 Line-No14 (01011100)	DS1 Line-No24 (01110000)
DS1 Line-No5 (01001010)	DS1 Line-No15 (01011110)	DS1 Line-No25 (01110010)
DS1 Line-No6 (01001100)	DS1 Line-No16 (01100000)	DS1 Line-No26 (01110100)
DS1 Line-No7 (01001110)	DS1 Line-No17 (01100010)	DS1 Line-No27 (01110110)
DS1 Line-No8 (01010000)	DS1 Line-No18 (01100100)	DS1 Line-No28 (01111000)
DS1 Line-No9 (01010010)	DS1 Line-No19 (01100110)	DS1 Line-All (00100110)

- Amount** is the number of Channel Codeword to be generated: **1 to 15** (Default is **10**).
- **Inject** generates the defined loopback command.

Received Messages

Displays current and previous alarms/status and loopback commands as well as the link activity for the received DS3 signal.

- **Link Activity**
 - **None (All 1's):** An all ones pattern (11111111 11111111) has been detected in the last second.
 - **Alarm/Status:** An Alarm/Status codeword has been detected in the last second. An Alarm/Status is only detected when receiving at least 10 consecutive occurrences of a specific codeword.
 - **Loopback:** A Loopback command message has been detected in the last second. A valid loopback command is detected only when receiving 10 consecutive occurrences of a specific **Loopback Command** immediately followed by 10 occurrences of a specific **Channel Codeword**.
 - **Unassigned:** An unassigned message has been detected in the last second. An Unassigned message is only detected when receiving at least 10 consecutive occurrences of a specific unassigned codeword. An **Alarm/Status** codeword is also reported since **Unassigned** is part of the **Alarm/Status** group.
- **Alarm/Status and Unassigned** displays the current and previously received **Codeword** messages.
 - **Current** indicates the last valid message, if any, received in the last second of measurement.
 - **Previous** indicates the message, if any, that was received just before the current measurement.

Test Functions

FEAC

- **Loopback Commands**
 - **Current** displays the valid message received in the last second of measurement. A valid message is detected only when receiving 10 consecutive occurrences of a specific **Loopback Command** immediately followed by 10 occurrences of a specific **Channel Codeword**.
 - **Previous** displays the last valid message received excluding the actual **Current** message.

Filters

Allows gathering statistics according to the programmed filters. Filters provide the capability to analyze a specific stream's behavior in order to monitor a single protocol's behavior, perform SLA verification, or precisely troubleshoot unwanted behavior. Up to 10 filters having up to four operands each can be defined and enabled.

From the **Test** menu, tap **Functions**, and the **Filters** tab.

P1 and P2 Buttons

The **P1** and **P2** buttons, available with **Dual Port** topology, allow respectively displaying results for port #1 (**P1**) or port #2 (**P2**).

Filters

Allows the selection of the filter number (1 to 10). The filter criteria, if defined, will be displayed. A filter used (enabled) for data capture will not be configurable and the message **Filter in use for data capture** is displayed.

Enable

Once the filter is configured, select the **Enable** check box to enable the current filter. However, if the filter configuration contains errors, it will not be possible to enable it. A filter can be enabled or disabled even when the test is running. It is not possible to modify or disable a filter that is already in use for capture until either another filter or **Interface** (see *Capture Source* on page 571) is assigned to capture.

Enabled Time

Indicates the time during which the filter is enabled.

Assign to Capture

Note: *Only available when the ETH-CAPTURE software option is enabled. Refer to Software Option on page 34 for more information.*

Assigns the selected filter for packet capture. See *Packet Capture* on page 571.

Filter Configuration

Note: *Multiple filter criteria is only available when the ADV-FILTERS option is enabled; otherwise only one criterion is possible. Refer to Software Option on page 34 for more information.*

The filter configuration section allows configuring the filter criteria for the selected filter. The configuration is only possible when the **Enable** check box is cleared.

- “(“ and “)”“, the open and close parenthesis controls the precedence of operands when more than two operands are used. Only one level of parenthesis is supported. When no parenthesis are used, a logical AND has precedence over a logical OR.
- **Not** check box when selected, adds the logical negation (not equal) operator for the operand filter defined at its right.

- **Filter** specifies the filter to be used (**None** by default).

Category	Filter
Ethernet	MAC Destination Address, MAC Source Address, EtherType ^a , C-VLAN ID, S-VLAN ID, E-VLAN ID, C-VLAN Priority, S-VLAN Priority, E-VLAN Priority
IPv4	IPv4 Destination Address, IPv4 Source Address, IPv4 TOS, IPv4 Precedence, IPv4 Protocol, IPv4 DiffServ
IPv6 ^b	IPv6 Destination Address, IPv6 Source Address, IPv6 Flow Label, IPv6 Next Header ^c , IPv6 Traffic Class, IPv6 Precedence, IPv6 DiffServ
Higher Layer	TCP Destination Port ^d , TCP Source Port ^d , UDP Destination Port, UDP Source Port
MPLS ^b	MPLS Label 1, MPLS Label 2, MPLS COS 1, MPLS COS 2

- a. Applies only to the last EtherType occurrence when VLAN is used.
- b. Available when the corresponding software option is enabled (refer to page 34).
- c. Applies only to the last next header occurrence when extension headers are used.
- d. Available with 10M to 10G interface rates only.

- **Value** is the value associated to the selected filter.

Test Functions

Filters

- **Mask** allows masking the defined filter value. A bit mask of 1 indicates that the corresponding bit in the value is compared for the match. A bit mask of 0 indicates that the corresponding bit in the value is ignored.

For binary values, enter the mask value in binary format.

For decimal values, enter the mask value in hexadecimal format.

For IP address field, enter the mask in decimal format.

For MAC address, enter the mask value in hexadecimal format.

- **Oper.** specifies the logical operator (AND or OR) used between two operands.

Filter Statistics

Indicates throughput statistics of frame matching the configured filter's criteria.

- **Line Utilization** gives the percentage of line rate utilization.
- **Ethernet BW** (Bandwidth) gives the receiving data rate expressed in Mbit/s.
- **Frame Rate** gives the receiving number of frames (including bad frames) in frame/s.
- **Frame Count** indicates the number of frame matching the configured filter's criteria.
- **Error Count** indicates respectively the number of frames matching the configured filter's criteria having **IP Checksum**, **UDP Checksum**, **TCP Checksum**, **FCS**, **Jabber**, **Oversize**, **Runt**, or **Undersize** errors. Refer to *Ethernet* on page 359 and *IP/UDP/TCP* on page 376 for more information on errors.

Packet Capture

Capture is used to analyze all or filtered data traffic and save complete or truncated frames into a buffer. It allows observing network truncated data precisely, or understanding errors and unwanted behavior.

From the **Test** menu, tap **Functions**, and the **Packet Capture** tab.

P1 and P2 Buttons

The **P1** and **P2** buttons, available with **Dual Port** topology, allow respectively displaying results for port #1 (**P1**) or port #2 (**P2**).

Capture Source

Specifies what kind of data to be captured.

- **Interface** captures all received frames and saves them in the capture buffer.
- **Filter x** captures only frames that match the selected filter and saves them in the capture buffer. Select the filter number from the list. Only enabled filters are available, see *Filters* on page 567.

The selected filter will be reserved for data capture and will not be available for filter configuration.

Frame Length

Specifies the length of the frame that will be saved in the capture buffer.

- **Complete** captures the entire frames.
- **Truncated** captures only the first specified number of bytes per frame. Use either the Bytes field to manually enter the number of bytes per frame or tap on the **Truncation Calculator** button for automatic bytes per frame calculation.

Bytes allows the selection of the number of bytes that will be saved in the capture buffer for each frame captured: 14 (default) to 1536 bytes.

Truncation Calculator allows determining easily at what byte to truncate the frame captured by selecting the desired frame header components.

- **Header Layer** specifies the header layer level: **Layer 2 (Ethernet)**, **Layer 3 (IP)**, or **Layer 4 (TCP/UDP)**.
- **IP Version** specifies the IP version: **IPv4** or **IPv6**.
- **Encapsulation** parameters are optional and not selected by default.

VLAN check box, when selected, enables VLAN and allows selecting the number of VLANs: 1, 2, or 3.

MPLS check box, when selected, enables MPLS and allows selecting the number of labels: 1 or 2.

EoE check box, when selected, enables EoE

PBB-TE check box, when selected, enables PBB-TE.

- **Additional Payload (bytes)** allows selecting optionally the number of additional payload bytes (1 to 1400 bytes).
- **Total Number of Bytes** indicates the number of bytes for the selected frame parameters. This value will be used as the truncated frame length (**Truncated** field).

Trigger

- **Trigger Type** defines the trigger source criterion that will be used to automatically start/stop the capture when a received frame matches the filter and the trigger criteria.
 - **Manual** automatically starts the frame capture when the Capture button is on (green LED) and the test is started (refer to *Start/Stop | TX Button* on page 657).
 - **On Error** starts the frame capture when the selected error occurs.

FCS

Jabber

Oversize (Available when **Oversize Monitoring** is enabled)

Runt

Undersize

IP Checksum

UDP Checksum

TCP Checksum

Any Type (Any of the above errors).

- **Field Match** starts the frame capture when the configured field match is encountered. Use the **Configuration** button to select the field match criteria (see **Filter Configuration** from the **Filters** tab).

Cfg. Status indicates the status of the configured field match configuration: **Valid** or **Invalid**. A valid status is required to be able to start the capture.

Test Functions

Packet Capture

- **Trigger Position** selects the triggered frame position within the buffer.
 - **Post-Trigger** for a trigger frame located at the beginning of the buffer. The buffer will contain the triggered frame with the following frames.
 - **Mid-Trigger** for a trigger frame located at the middle of the buffer. The buffer will contain the triggered frame with the preceding and following frames.
 - **Pre-Trigger** for a trigger frame located at the end of the buffer. The buffer will contain the triggered frame with the preceding frames.

Status and Controls

- **Capture Status** indicates the status of the data capture:
 - “--”: The capture is not started and has not run yet.
 - Armed...**: The capture is started but waiting for the trigger event.
 - Capturing...**: The capture is in progress. For Post-Trigger and Mid-Trigger mode, the trigger event has been captured and the buffer is filling up.
 - Completed**: The capture is completed.
- **Frame Count** indicates the number of frames captured that matches the selected filter criteria. However, for Mid-trigger and Pre-Trigger, the frame counter will only be available when the capture is completed.
- **Buffer Usage** indicates the percentage of the buffer capacity used.
- **Triggered Error** is available when trigger on error is selected and indicates the error that activated the trigger.

- **Triggered Frame - Details** gives details on the triggered frame.

The triggered frame corresponds to the first received frame that matches the filter and the trigger settings.

Frame Number indicates the triggered frame position in the buffer.

The framing MAC/IP/UDP/TCP source and destination addresses are displayed in a table.

- **Capture** button allows starting/stopping the data capture. The test must be running (refer to *Start/Stop | TX Button* on page 657) in order to start capturing and recording data into the buffer. The Capture button is not available when the trigger on field match is selected while its trigger parameters are not valid.

No data will be recorded in the buffer if no frame matches the filter and the trigger criteria during the data capture.

The data capture stops automatically once the buffer is full. The maximum buffer capacity is 64 KBytes or a maximum of 2078 frames for rates up to 10GE and 512 KBytes or a maximum of 8192 frames for rates 40GE and 100GE.

When the capture stops or is manually stopped, the following message is displayed: **Capture completed. Press Export to save captured data (the test must be stopped)**. To avoid losing the captured data, the data must be exported and saved into a file before restarting the test or creating a new test.

- **Export** button, available when the test application is stopped, allows exporting the data captured into a .pcap file format and viewing the file using Wireshark.

- **Save In:** Allows selecting the folder to save the capture file.

The capture file is saved in the following folder by default:
Users\<<User>\Documents\88000-PowerBlazer\CaptureData

Test Functions

Packet Capture

- **View File After Generation:** Allows displaying the report once it is generated using the Wireshark application. The **View File After Generation** check box is not selected by default.

- **Generate & Save**

Allows generating and saving the capture data. The name of the captured file is automatically selected and contains the date and time of the capture. Capture file bigger than 100Mbytes will be split into multiple files.

Tapping on the **Cancel** button stops the capture generation. The captured data already processed will be saved.

Note: *The export process may take several minutes.*

Once generated, the capture file will be automatically opened in Wireshark when the **View File After Generation** check box is selected.

The capture file report may also be manually opened within Wireshark typically using Windows Explorer.

GCC BERT

Note: *Only supported with Coupled topology.*

From the **Test** menu, tap **Functions**, and the **GCC BERT** tab.

GCC Channels

GCC0, **GCC1**, and **GCC2** check boxes allow respectively enabling OTU GCC0, ODU GCC1, and ODU GCC2 generation and monitoring using a PRBS15 pattern. GCC1 and GCC2 are only available on the higher ODU layer of a multiplexed test. The status of the received pattern signal (per channel) is displayed in green for synchronized, red for loss of pattern, or gray for pending state.

PRBS15 Invert Pattern

PRBS15 Invert Pattern check box, when selected (cleared by default), inverts the test pattern meaning that every 0 will be changed for 1 and every 1 for 0. For example, the pattern 1100 will be sent as 0011.

BERT

- **Pattern Loss** indicates that the sequence synchronization is lost.
- **Bit Error** indicates that bit errors are detected on the received GCC Pattern.

Test Functions

GCC BERT

Bit Error

Allows selection of the GCC channel on which bit error will be injected. Only enabled GCC channels are listed; **All** selects all enabled GCC channels.

Inject generates bit errors on the selected GCC channel(s).

Reset

Resets GCC BERT statistics: **Pattern Loss** and **Bit Error**.

GMP

Note: Available with Transport test applications with either payload type 21 (PT21) or one of the following clients: **1GbE**, **40GbE**, **100GbE**, **Ethernet (flex/GFP-F)**, or **SONET/SDH (through ODU0)**.

From the **Test** menu, tap **Functions**, and the **GMP** tab.

Channel

Available with Multi-Channel OTN, allows the selection of the channel number.

Generic Mapping Procedure

- **TX Cm** indicates the minimum and maximum Cm value transmitted during the test.
- **TX CnD** indicates the minimum and maximum CnD value transmitted during the test.
- **RX Cm** indicates the minimum and maximum Cm value captured during the test.
- **RX CnD** indicates the minimum and maximum CnD value captured during the test.

OH - GFP-F/GFP-T

Note: Available with OTN BERT test application with **1GbE (GFP-T)**, **10GbE (GFP-F)**, or **Ethernet (flex/GFP-F)** client.

From the **Test** menu, tap **Functions**, **OH** tab, and **GFP-F/GFP-T** sub tab.

➤ **Core Header**

PLI and **cHEC** are not configurable.

➤ **Type Header**

The following settings are available for **Client Data** and **Client Management** frame types.

- **PTI** (Payload Type Identifier) allows overwriting the Payload Type Identifier.

PTI	Description
000	Client Data Frame
100	Client Management Frame
001, 010, 011, 101, 110, and 111	Reserved

- **PFI** (Payload Frame Check Sequence Identifier) allows overwriting the Payload FCS Indicator.

PFI	Description
0	FCS Absent
1	FCS Present

- **EXI** (Extension Header Identifier) allows overwriting the Extension Header Identifier.

EXI	Description
0000	Null Extension Header
0001	Linear Frame
0010	Ring Frame
0011 to 1111	Reserved

- **UPI** (User Payload Identifier) allows overwriting the User Payload Identifier.

UPI	Description for PTI = 000	Description for PTI = 100
0000 0000 1111 1111	Reserved and not available	Reserved
0000 0001	Frame-Mapped Ethernet	Client Signal Fail (Loss of Client Signal)
0000 0010	Mapped PPP Frame	Client Signal Fail (Loss of Character Synchronization)
0000 0011	Transparent Fibre Channel	Client Defect Clear Indication (DCI)
0000 0100	Transparent FICON	Client Forward Defect Indication (FDI)
0000 0101	Transparent ESCON	Client Reverse Defect Indication (RDI)
0000 0110	Transparent GbE	
0000 0111	Reserved for future use	
0000 1000	Frame-Mapped Multiple Access Protocol over SDH (MAPOS)	
0000 1001	Transparent DVB ASI	
0000 1010	Framed-Mapped IEEE 802.17 Resilient Packet Ring	
0000 1011	Frame-Mapped Fibre Channel FC-BBW	
0000 1100	Asynchronous Transparent Fibre Channel	
0000 1101	Framed MPLS Unicast	
0000 1110	Framed MPLS Multicast	
0000 1111	Framed IS-IS	
0001 0000	Framed IPv4	
0001 0001	Framed IPv6	

Test Functions

OH - GFP-F/GFP-T

UPI	Description for PTI = 000	Description for PTI = 100
0001 0010	Framed DVD-ASI	
0001 0011	Framed 64B/66B Ethernet	
0001 0100	Framed 64B/66B Ethernet Ordered Set	
0001 0101 through 1110 1111	Reserved for future standardization	
1111 0000 through 1111 1110	Reserved for proprietary use	
0000 0110 through 1101 1111		Reserved for future use
1110 0000 through 1111 1110		Reserved for proprietary use

- **Extension Header: CID and Spare** are only available when EXI is set to **Linear** (refer to **EXI** on page 181) and are available for **Client Data** and **Client Management** frame types.
 - **CID** (Channel IDentifier) allows overwriting the communication channel used for the signal transmission set from CID on page 181. Choices are from **00000000** through **11111111** (0 to 255). The default setting is 00000000.
 - **Spare** allows setting the extension header Spare field. Choices are from **00000000** through **11111111** (0 to 255).

Default all OH

Returns all TX overhead bytes to their factory default values.

RX

Note: *The following **Core Header**, **Type Header**, and **Extension Header** parameters are available for **Client Data**, **Client Management**, and **Reserved PTI** frames. The details of the selected OH field is displayed in the **OH Details** section on the bottom-right of the screen.*

➤ Core Header

- **PLI** (Payload Length Indicator) indicates the number of octets in the GFP payload area.
- **cHEC** (Core Header Error Control) indicates the CRC-16 error control code that protects the integrity of the contents of the core header by enabling both single-bit error correction and Multi-bit error detection.
- **Type Header:** See Type Header *on page 580* for **PTI**, **PFI**, **EXI**, and **UPI** possible values.
 - **PTI** (Payload Type Identifier) indicates the type of GFP client frame.
 - **PFI** (Payload Frame Check Sequence Indicator) displays the Payload FCS Indicator.
 - **EXI** (Extension Header Identifier) indicates the Extension Header Identifier.
 - **UPI** (User Payload Identifier) indicates the User Payload Identifier.
 - **tHEC** (Type Header Error Control) indicates the CRC-16 error control code that protects the integrity of the contents of the type field by enabling both single-bit error correction and multi-bit error detection.

Test Functions

OH - GFP-F/GFP-T

- **Extension Header: CID, Spare, and eHEC** are only available when EXI is set to **Linear** (refer to EXI on page 181).
 - **CID** (Channel IDentifier) indicates the communication channel used by the signal. Possible values are 00000000 through 11111111 (0 to 255).
 - **Spare** indicates the extension header Spare field. Possible values are 00000000 through 11111111 (0 to 255).
 - **eHEC** (Type Header Error Control) indicates the CRC-16 error control code that protects the integrity of the contents of the extension header by enabling both single-bit error correction (optional) and multi-bit error detection.

OH Details

Displays the details of the selected OH byte. The first column indicates the selected OH byte. The second column indicates respectively from top to bottom the bit numbers used, the byte value in binary, and the interpretation of the byte when applicable.

OH - OTN

For **OTN BERT**, from the **Test** menu, tap **Functions**, and the **OH** tab.

For **OTN SONET/SDH BERT**, from the **Test** menu, tap **Functions**, **OH**, and the **OTN** sub tab.

Allows respectively modifying the overhead information to be transmitted or viewing the overhead information received.

OTU_x/ODU_x and ODU_x Buttons

Tap on either the **OTU_x/ODU_x** or the **ODU_x** button to select the OH level.

Default OTN OH

Returns all TX overhead bytes to their factory default values.

TX/RX

Overhead bytes are organized using rows and columns structure as per G.709 standard.

Row 1

- **OA1** and **OA2**, columns 1-6, OTU FAS: All the Frame Alignment Signal **OA1** bytes and **OA2** bytes are individually configurable from **00** to **FF**. The default values are **F6** for all **OA1** bytes and **28** for all **OA2** bytes.
- **MFAS**, column 7, OTU MFAS: The Multi-Frame Alignment Signal byte is not configurable.
- **SM**, columns 8-10, OTU OH: The Section Monitoring contains the following bytes.

The first SM byte (column 8) contains the TTI multiframe byte that is only configurable from *Traces (OTN)* on page 332.

The second SM byte (column 9) contains the BIP-8 byte that is automatically generated for each frame. This byte is not configurable.

Test Functions

OH - OTN

The third SM byte (column 10) contains the following sub-fields. This byte is configurable from **00** (default) to **FF**.

Bit 1-4	Bit 5	Bit 6	Bit 7-8
BEI/BIAE	BDI	IAE	RES

- **GCC0**, columns 11-12, OTU OH: The two General Communication Channel-0 bytes are configurable from **00** (default) to **FF**. Not configurable when GCC0 check box is selected from *GCC BERT* on page 577.
- **RES**, columns 13-14, OTU OH: The two Reserved (RES) bytes are configurable from **00** (default) to **FF**.
- **JC4** or **RES**¹
JC4, column 15, OPU OH: Bits 1-3 set to all-0s, and bits 4-8 are controlled by GMP function. This byte is not configurable.
RES, column 15, OPU OH: The Reserved (RES) byte is configurable from **00** (default) to **FF**.
- **JC1** or **JC**¹
JC1, column 16, OPU OH: Controlled by GMP function. This byte is not configurable.
JC, column 16, OPU OH:
 - Bits 1-6, Reserved (RES), are configurable from binary **000000** (default) to **111111**.
 - Bits 7-8, Justification Control (JC), are configurable from binary **00** (default) to **11**. Not available with ODU mux. Changing the JC value will corrupt the payload.

1. Depending on the test MUX/Mapping.

Row 2

- **RES**, columns 1-2, ODU OH: The two Reserved (RES) bytes are configurable from **00** (default for each byte) to **FF**.
- **PM & TCM**, column 3, ODU OH: The Path Monitoring and Tandem Connection Monitoring byte is configurable from **00** (default) to **FF**.
- **TCM ACT**, column 4, ODU OH: The Tandem Connection Monitoring Activation is configurable from **00** (default) to **FF**.
- **TCM6/TCM5/TCM4**, column 5-13, ODU OH: The Tandem Connection Monitoring overhead contains the following bytes.

The first TCMi byte contains the TTI multiframe byte and is only configurable from *Traces (OTN)* on page 332.

The second TCMi byte contains the BIP-8 byte and is automatically generated for each frame. This byte is not configurable.

The third TCMi byte contains the following sub-fields. This byte is configurable from **00** to **FF**. The default value is **00** when TCMi is disabled, and **01** when enabled.

Bit 1-4	Bit 5	Bit 6-8
BEI/BIAE	BDI	STAT

- **FTFL**, column 14, ODU OH: The Fault Type Fault Location multiframe byte is only configurable from *FTFL/PT and PT* on page 177.
- **JC5** or **RES**¹

JC5, column 15, OPU OH: Bits 1-3 set to all-0s, and bits 4-8 are controlled by GMP function. This byte is not configurable.

RES, column 15, OPU OH: The Reserved (RES) byte is configurable from **00** (default) to **FF**.

1. Depending on the test MUX/Mapping.

Test Functions

OH - OTN

➤ **JC2 or JC¹**

JC2, column 16, OPU OH: Controlled by GMP function. This byte is not configurable.

JC, column 16, OPU OH:

- Bits 1-6, Reserved (RES), are configurable from binary **000000** (default) to **111111**.
- Bits 7-8, Justification Control (JC), are configurable from binary **00** (default) to **11**. Not available with ODU mux. Changing the JC value will corrupt the payload.

Row 3

- **TCM3/TCM2/TCM1**, columns 1-9, ODU OH: See *TCM6/TCM5/TCM4* on page 587 for more information.
- **PM**, column 10-12, ODU OH: The Path Monitoring overhead contains the following bytes.

The first PM byte (column 10) contains the TTI byte that is not configurable.

The second PM byte (column 11) contains the BIP-8 byte and is automatically generated for each frame. This byte is not configurable.

The third PM byte (column 12) contains the following sub-fields. This byte is configurable from **00** to **FF**. The default value is **01**.

Bit 1-4	Bit 5	Bit 6-8
BEI	BDI	STAT

- **EXP**, column 13-14, ODU OH: The two Experimental overhead bytes are configurable form **00** (default for each byte) to **FF**.

1. Depending on the test MUX/Mapping.

➤ **JC6 or RES¹**

JC6, column 15, OPU OH: Bits 1-3 set to all-0s, and bits 4-8 are controlled by GMP function. This byte is not configurable.

RES, column 15, ODU OH: The Reserved (RES) bytes are configurable from **00** (default) to **FF**.

➤ **JC3 or JC¹**

JC3, column 16, OPU OH: Controlled by GMP function. This byte is not configurable.

JC, column 16, OPU OH:

➤ Bits 1-6, Reserved (RES), are configurable from binary **000000** (default) to **111111**.

➤ Bits 7-8, Justification Control (JC), are configurable from binary **00** (default) to **11**. Not available with ODU mux. Changing the JC value will corrupt the payload.

Row 4

➤ **GCC1**, column 1-2, ODU OH: The two General Communication Channel-1 bytes are configurable from **00** (default for each byte) to **FF**. Not configurable when GCC1 check box is selected from *GCC BERT* on page 577.

➤ **GCC2**, column 3-4, ODU OH: The two General Communication Channel-2 bytes are configurable from **00** (default for each byte) to **FF**. Not configurable when GCC2 check box is selected from *GCC BERT* on page 577.

➤ **APS/PCC**, column 5-8, ODU OH: The Automatic Protection Switching / Protection Communication Channel overhead bytes are defined in the ITU-T G.709 standard. These bytes are configurable from **00** (default) to **FF**.

1. Depending on the test MUX/Mapping.

Test Functions

OH - OTN

- **RES**, column 9-14, ODU OH: The six Reserved (RES) bytes are configurable from **00** (default for each byte) to **FF**.
- **PSI**, column 15, OPU/ODU OH: Tap the PSI field to configure (TX) or display (RX) the Payload Structure Identifier.
 - TX: Select any TX byte from the list and its content is displayed below the list. Tap the **Edit** button to change its value.
 - RX: Select any RX byte from the list and its content is displayed below the list.
 - **Link TX/RX Scrolling**, when selected (cleared by default), allows synchronizing both TX and RX table allowing to see the same TX and RX PSI byte numbers when scrolling from either TX or RX table.
 - **Foreground Signal Label**: Indicates the status of the MSI for each PSI#, either **MSI TX** (black), **Expected MSI RX** (green), or **MSI Mismatch** (red).
- **OMFI** or **NJO**
 - OMFI**, column 16, OPU OH: OPU Multi-Frame Identifier is only available for OPU4 of a mapped signal. This byte is not configurable.
 - NJO**, column 16, ODU OH: The Negative Justification Opportunity byte is not configurable. Available either for non-concatenated signal or on the LO of a concatenated signal.

RX

- **RX OH Byte Details** displays the content of the selected OH RX byte. Tap on any OH RX byte to see its content
- **Legend TX/RX** indicates the path level for all OH bytes.

OH - SONET/SDH

The SONET/SDH OH page allows modifying (TX) the overhead information to be transmitted and viewing (RX) the overhead information received.

For **SONET/SDH BERT**, from the **Test** menu, tap **Functions**, and the **OH** tab.

For **OTN-SONET/SDH BERT**, from the **Test** menu, tap **Functions**, **OH**, and the **SONET/SDH** sub tab.

Tap on any overhead byte in TX to modify its value.

Tap on any overhead byte in RX to see its detailed content/value.

Note: *A byte in TX that has no value displayed or is grayed out, is not configurable from the OH tab.*

TX and RX Buttons (SDH)

Tap on the TX or RX button to respectively access the overhead bytes in transmission or receive mode.

STS-1 Timeslot/STM-1 Channel

Allows selecting the timeslot number for the Transport OH bytes. The STS/AU/TU-3 overhead bytes are always for the timeslot selected in the test configuration. Furthermore when modifying the Transport OH bytes H1 SS bits, the modification applies to all timeslots when the test topology is **Coupled**. Choices are **1** (default) to **192** (SONET) / **64** (SDH) depending on the OC-N/STM-N interface selected.

Transport OH - Section/RS

- **A1 and A2:** Framing. The value should be hexadecimal **F6** for A1 and **28** for A2. They must appear in every STS-1/STM-1 frame of a composite signal.

SONET: Provide frame alignment of each STS-1 frame within a composite signal (STS-1 to STS-n).

SDH: Indicate the beginning of the STM-N frame.

- **J0/Z0**

- **J0:** The J0 (Trace) byte is used to trace the origin of an STS-1/STM-1 frame as it travels across the SONET/SDH network. This byte is only defined for the first STS-1/STM-1 frame of a composite signal. Available when the Trace format is set to 1 Byte (refer to *Traces (SONET/SDH)* on page 336).

- **Z0:** Growth.

SONET: The Z0 byte was used to uniquely identify the STS in question. This byte has to be defined in every STS-1 to STS-n frame of a composite signal. This byte is only defined for the STS-1 #2 to STS-1 #N of a OC-N signal.

SDH: These bytes are reserved for future international standardization. They are located at positions $S[1,6N+2]$ to $S[1,7N]$ of an STM-N signal ($N > 1$).

- **B1:** BIP-8 (Bit-Interleaved Parity) byte provides section error monitoring. This byte is only defined for the first STS-1/STM-1 frame of a composite signal. The byte is calculated by performing a routine even-parity check over all bits of the previous STS-N/STM-N frame of a composite signal.
- **E1:** Orderwire. Provides a 64 Kbit/s voice channel for communication between two STEs (Section Terminating Equipment). This byte is only defined for the first STS-1/STM-1 frame of a composite signal.

- **F1:** User/User Channel. This byte is reserved for user purposes. This byte is only defined for the first STS-1/STM-1 frame of a composite signal.
- **D1, D2, and D3:** Data Communications Channel (DCC). Provides a 192 Kbit/s data communication between two STEs for operation functions such as OAM&P. These bytes are only defined for the first STS-1/STM-1 frame of a composite signal.

Transport OH - Line/MS

- **H1 and H2:** Pointer.

SONET: H1 and H2 bytes are combined to form a pointer indicating where the path overhead begins within each SPE.

SDH: H1 and H2 bytes are combined to form a pointer indicating where the VC (Virtual Container) frame begins within each SPE.

Bits 5 and 6 of the H1 byte represent the SS bits and are configurable as follows:

SS Bits	Description
00	SONET
01	Undefined
10	SDH
11	Undefined

- **H3:** Pointer Action. H3 is an extra byte used to compensate for the SPE timing variation. The H1 and H2 pointer tell the receiver when the H3 pointer is used.

SONET: This byte must be defined in every STS-1 to STS-n frame of a composite signal.

SDH: This byte must be defined in every STM-1 of an STM-N signal in the event of negative justification, otherwise it is not defined.

Test Functions

OH - SONET/SDH

➤ **B2: BIP-8**

SONET: The BIP-8 (Bit-Interleaved Parity) byte provides line error monitoring. This byte is only defined for the first STS-1/STM-1 frame of a composite signal. The byte is calculated by performing a routine even-parity check over all bits of the LOH and the STS-1 frame capacity of the previous frame of a composite signal (STS-1 to STS-n). Note that the SOH is not used to calculate the parity check.

SDH: The MS BIP-N*24 (Bit-Interleaved Parity) byte provides line error monitoring. The byte is calculated by performing a routine even-parity check over all bits of the MSOH and the STM-N frame of the previous STM-N frame. Note that the RSOH is not used to calculate the parity check.

➤ **K1 and K2: Automatic Protection Switching (APS):** The K1 and K2 bytes communicate APS between two LTE. These bytes are only defined for the first STS-1/STM-1 frame of a composite signal.

➤ **D4 through D12: Data Communications Channel (DCC):** The D4 through D12 bytes provide a 576 Kbit/s data communications channel between two LTEs for administration, monitoring and other communications. These bytes are only defined for the first STS-1/STM-1 frame of a composite signal.

➤ **S1/Z1 (SONET)**

S1: Synchronization Status: The S1 byte is used to carry the synchronization status of the SONET device. This byte is only defined for the first STS-1/STM-1 frame of a composite signal.

Z1: Growth. This byte is located in the second STS-1 through STS-n frame of a composite signal (STS-1 #2, STS-1 #3, up to STS-1 #N of a OC-N (N>3) signal).

➤ **S1 (SDH): Synchronization Status.** Bits 5 to 8 of the S1 byte are used to carry the synchronization messages of the SDH device. This byte is only defined for the first STS-1/STM-1 frame of a composite signal.

➤ **M0 or M1/Z2 (SONET)**

M0: REI-L: The M1 byte is used for line Remote Error Indication (REI-L)

- For STS-1e and OC-1: The M0 byte located in the STS-1 indicates BIP violations.

M0, bits 234 5678	Indicates
000 0000	0 BIP violation
000 0001	1 BIP violation
:	:
000 1000	8 BIP violations
000 1001 to 1111 1111	0 BIP violation

- For OC-192: The M0 bytes located in the STS-1 #4 indicates BIP violations when combined with the M1 byte (see M1 byte below for more information).

M1: REI-L. The M1 byte is used for line Remote Error Indication (REI-L).

- For STS-3e and OC-3: The M1 byte located in the STS-1 #3 indicates BIP violations.

M1, bits 234 5678	Indicates
000 0000	0 BIP violation
000 0001	1 BIP violation
:	:
001 1000	24 BIP violations
001 1001 to 1111 1111	0 BIP violation

Test Functions

OH - SONET/SDH

- For OC-12: The M1 byte located in the STS-1 #7 indicates BIP violations.

M1, bits 234 5678	Indicates
000 0000	0 BIP violation
000 0001	1 BIP violation
:	:
110 0000	96 BIP violations
110 0001 to 1111 1111	0 BIP violation

- For OC-48: The M1 byte located in the STS-1 #7 indicates BIP violations.

M1	Indicates
0000 0000	0 BIP violation
0000 0001	1 BIP violation
:	:
1111 1111	255 BIP violations

- For OC-192: Either the M1 byte located in the STS-1 #7, or the combination of the M0 and M1 bytes indicates BIP violations (refer to *REI-L Computation Method* on page 308).

For **M1 Only** computation method:

M1	Indicates
0000 0000	0 BIP violation
0000 0001	1 BIP violation
:	:
1111 1111	255 BIP violations

For **M0** and **M1** computation method:

M0 Located in STS-1 #4	M1 Located in STS-1 #7	Indicates
0000 0000	0000 0000	0 BIP violation
0000 0000	0000 0001	1 BIP violation
:	:	:
0000 0110	0000 0000	1536 BIP violations
0000 0110 to 1111 1111	0000 0001 to 1111 1111	0 BIP violation

Z2: Growth. Available with OC-3, OC-12, and OC-48 signal, this byte is located in STS-1 #1 up to STS-1 #48 except for timeslots used by M0 and M1.

Undefined “--” for all other timeslots not covered by M0, M1, and Z2.

➤ **M0 or M1 (SDH)**

M0: MS-REI. STM-1 channel #1 of a STM-0 signal; channel #2 of an STM-64 signal.

M1: MS-REI. STM-1 channel #1 of a STM-1 signal; channel #3 of an STM-N signal (N>1).

Undefined “--” for all other channels not covered by M0, and M1.

➤ **E2:** Orderwire. Provides a 64 Kbit/s voice channel for communication between LTEs. This byte is only defined for the first STS-1/STM-1 frame of a composite signal.

STS/AU/TU-3

- **J1:** Trace. Available when the Trace format is set to 1 Byte (refer to *Traces (SONET/SDH)* on page 336).

SONET: The J1 Trace byte provides a 16 or 64 byte fixed string to verify connection between path transmitting equipment and path receiving equipment.

SDH: The higher-order (AU)/low-order (TU) VC-N path trace byte provides a 64 byte fixed string to verify connection between path transmitting equipment and path receiving equipment.

- **B3:** BIP-8. The BIP-8 (Bit-Interleaved Parity) byte provides path error monitoring. The byte is calculated by performing an even-parity check over all bits of the previous SPE.

- **C2: Signal Label.** Entering a C2 byte value will automatically update the Path Signal Label (C2) selection and vice versa. Refer to *STS/AU Path (C2)* on page 196 for more information.

C2 (Hex.)	Description	
	SONET	SDH
00 ^a	Unequipped	UNEQ or supervisory-UNEQ
01	Equipped - Non-Specific	RES (Equipped - Non-Specific)
02	Floating VT Mode (Default)	TUG Structure
03	Locked VT Mode	Locked TU-n
04	Async Mapping for DS3	Async Mapping of 34M/45M in C-3
05	Mapping under development	Experimental Mapping
12	Async Mapping for 140M (DS4NA)	Async Mapping of 140M in C-4
13	Mapping for ATM	ATM Mapping
14	Mapping for DQDB	MAN DQDB
15	Async Mapping for FDDI	FDDI [3]-[11] Mapping
16	Mapping of HDLC over SONET	Mapping of HDLC/PPP
17	SDL with self-sync scrambler	RES (SDL self-synch scrambler)
18	Mapping of HDLC/LAPS	Mapping of HDLC/LAPS
19	SDL with a set-reset scrambler	RES (SDL set-reset scrambler)
1A	10 Gbit/s Ethernet (IEEE 802.3)	10 Gbit/s Ethernet (IEEE 802.3)
1B	GFP	GFP
1C	Not supported	Mapping 10 Gbit/s FC
20	Not supported	Async Mapping of ODUk
CF	RES (Obsolete HDLC/PPP framed)	RES (obsolete HDLC/PPP framed)
E1 ^a to FC ^a	STS-1 w/1 VTx PD, STS-1 w/2 VTx PD, ... STS-1 w/28 VTx or STS-n/nc PD	Not supported
FE	Test Signal, ITU-T 0.181	Test Signal, ITU-T 0.181
FF ^a	STS SPE AIS (TCM)	VC-AIS (TCM)

- a. These values cannot be selected as Expected Path Signal Label.

Test Functions

OH - SONET/SDH

- **G1:** Path Status. The G1 byte provides a method to communicate the far-end path status back to the path originating equipment.

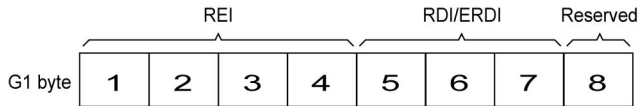

REI:

Bits 1 to 4 of G1	Description
0000	No error
0001	1 error
0010	2 errors
:	:
1000	8 errors
1001 to 1111	No error

RDI/ERDI:

Bits 5, 6, 7 of G1	Description
000, 001, 011	No defect
100, 111	RDI
010	ERDI-PD
101	ERDI-SD
110	ERDI-CD

- **F2:** User Channel. The User Channel provides a 64 Kbit/s channel for communication between two PTEs. This byte is only defined for the first STS-1/STM-1 frame of a composite signal.
- **H4:** Multiframe Indicator. The H4 byte provides a multiframe phase indication of a VT/TU payload.

- **Z3 and Z4:**
SONET only: Growth.
- **F3:**
SDH only: User Channel. The Path User Channel provides a channel for communication purposes between path elements and is payload dependent.
- **K3:**
SDH only: Automatic Protection Switching (APS). Bits 1 to 4 of the K3 byte are used for APS signaling. K3 bits 5 to 8 are reserved for future use.
- **N1:**
SONET: The N1 byte (formerly referred to as the Z5 byte) is allocated for Tandem Connection Maintenance (TCM) and the Path Data Channel.

SDH: (Network operator byte) The N1 byte is allocated to provide a Higher-Order Tandem Connection Monitoring (HO-TCM) function.

Test Functions

OH - SONET/SDH

VT/TU

➤ V5 VT/TU Path Overhead

The V5 byte is allocated to indicate the content of the VT/TU path, including the status of the mapped payloads. It provides the same functions for VT/VC paths that the B3, C2, and G1 bytes provide for STS/STM paths.



- **BIP-2** is not configurable.
- **REI, RFI, and RDI:** Choices are **0** (disabled), and **1** (enabled).
- Signal Label

Bits 5, 6, 7 of V5	Description	
	SONET	SDH
000 ^a	Unequipped	Unequipped or supervisory-unequipped
001	Reserved (Equipped - Non-specific)	
010	Asynchronous	
011	Bit Synchronous	
100	Byte Synchronous	
101	Extended Signal Label	
110	Test Signal, ITU-T 0.181 specific mapping	
111 ^a	VT SPE AIS (TCM)	VC-AIS (TCM)

a. These bytes cannot be selected in receive mode.

If the signal label in V5 (bits 5, 6, and 7) is 101 the contents of the extended signal label is valid and contains in a 32 bit multiframe as shown below. See Z7/K4 Structure shown below.

Z7/K4 Structure

1	2	3	4	5	6	7	8	9	10	11	12	13	14	15	16	17	18	19	20	21	22	23	24	25	26	27	28	29	30	31	32				
Multiframe Alignment Signal											Extended Signal Label							0	R	R	R	R	R	R	R	R	R	R	R	R	R	R	R	R	
Frame Count				Sequence Indicator																															

R = Reserved

- **J2 Trace.** Available when the Trace format is set to 1 Byte (refer to *Traces (SONET/SDH)* on page 336).

SONET: VT Path Trace: The J2 Trace byte provides a 16 or 64 bytes fixed string allowing the receiving VT PTE to verify its continued connection to the intended transmitting VT PTE.

SDH: Path Trace: The J2 byte is used to repetitively transmit a Lower-Order Access Path Identifier so that a path receiving terminal can verify its continued connection to the intended transmitter.

- **Z6/N2**

Z6 (SONET): VT Tandem Connection Monitoring or VT Path Growth. The Z6 byte is allocated for future growth.

N2 (SDH): (Network operator byte) Tandem Connection Monitoring for the VC2, VC-12, and VC-11 level.

Test Functions

OH - SONET/SDH

► Z7 /K4 : Extended signal label

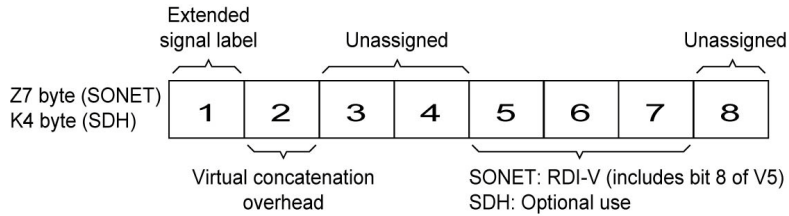

Bits	Description	
	Z7 (SONET)	K4 (SDH)
1	Extended signal label. Bits 12 to 19 of the 32 bit frame multiframe (see <i>Z7/K4 Structure</i> on page 603) contain the extended signal label.	
2	Virtual concatenation. Bits 1 to 5 of the 32 bit frame multiframe (see <i>Z7/K4 Structure</i> on page 603) contain the LO virtual concatenation frame count while bits 6 to 11 contain the LO virtual concatenation sequence indicator.	
3 - 4	unassigned and reserved for APS signaling for protection at the lower order path level.	
5 - 7	These bits in combination with bit 8 of V5 are allocated for RDI -V/ERDI-V signal	Optional use.
8	unassigned and reserved for a lower order path data link.	

Default all OH

Returns all TX overhead bytes to their factory default values.

Ping & Trace Route

From the **Test** menu, tap **Functions**, and the **Ping & Trace Route** tab.

P1 and P2 Buttons

The **P1** and **P2** buttons, available with **Dual Port** topology, allow respectively displaying the alarms/errors for port #1 (**P1**) or port #2 (**P2**).

Source IP Address

Displays the configured **Source IP Address**. Refer to *MAC/IP/UDP* on page 204 for RFC 2544 and EtherBERT tests, and to *Smart Loopback* on page 311 for Smart Loopback test.

Destination IP Address

Enter the **Destination IP Address** of the network device to be detected. The destination IP address is configurable only with **IPv4 Network Layer** (refer to *Modify Structure Button* on page 108). The accepted range for IPv4 is **0.0.0.0** (default) to **255.255.255.255**.

The default setting for IPv6 is **2001:0000:0000:0000:0000:0000:0000:0000** or is set automatically to the IP address of the target module from the Remote Loopback mode. The destination IP address is configured only when **Ethernet/IPv6/UDP** is selected. The **IPv6 Address** can either be the **Link-Local IPv6 Address** or the **Global IPv6 Address**. The acceptable range for IPv6 is from **000:0000:0000:0000:0000:0000:0000:0001** to **FFFF:FFFF:FFFF:FFFF:FFFF:FFFF:FFFF:FFFF**.

Stream

Stream is available with EtherSAM and Traffic Gen & Mon and allows selecting a stream/service to use its source and destination IP addresses for the Ping and Trace Route tests.

Use Stream

Use Stream, available with test application using stream/services, allows using the source and destination IP of the defined or selected stream/services.

Ping

- **Data Size (Bytes)**: Enter the data size that will be sent to the network device to be detected. Choices are **0 to 1452 bytes; 32 bytes** by default.
- **TTL for IPv4 and Hop Limit (TTL) for IPv6**: Enter the maximum number of hops the packet can go through. Choices are **1 to 255; 128** by default.
- **IP TOS/DS for IPv4 and Traffic Class (TOS/DS) for IPv6**: Enter the type of service. Choices are **00** (default) to **FF**.
- **Flow Label (IPv6)** value acceptable range is from **0** (default) to **1048575**.
- **Timeout (ms)**: Enter the maximum time allowed between an ICMP echo and response. Choices are **200 ms to 10000 s; 4000 ms** by default.
- **Delay (ms)**: Enter the delay between each attempt (PING). Choices are **100 to 10000 ms; 1000 ms** by default.
- **Attempts**: Select **n-Attempts** to specify the number of ping requests to send following a ping activation or select **Continuous** to ping continuously until manually stopped. If **n-Attempts** is selected, enter the number of ping attempts from **1 to 100**. The default setting is **n-Attempts** with **4** attempts.
- **Ping** button starts the ping tool with the specified settings.

Trace Route

- **Max Hop Count:** Enter the maximum network device the packet is allowed to go through. Choices are **1** to **255**; **128** by default.
- **Timeout (ms):** Enter the maximum time allowed between an ICMP echo and response at each hop. Choices are **200 ms** to **10000 ms**; **4000 ms** by default.
- **Trace Route** button starts the trace route tool with the specified settings.

Results

To succeed, a ping command shall be acknowledged by the network device within a given delay (**Timeout**). Typically a ping command can fail for the following reasons:

- The IP address is unavailable or unknown.
- The time allowed to perform the ping command is too short.
- The remote device is not supporting ICMP messaging.

To succeed, a trace route command shall be acknowledged by the network device within a given delay (Timeout). Typically a trace route command can fail for the following reasons:

- The IP address is unavailable or unknown.
- The time allowed to perform the trace route command is too short.
- The remote device is not supporting ICMP messaging.

The ping and trace route results are displayed with the following columns:

- **No.:** Indicates the attempt number.

Test Functions

Ping & Trace Route

► **Status:** Indicates the status of the attempt as follows:

Status	Description
Successful	Valid ICMP echo reply received.
User Aborted	When a user has manually stopped the ping/trace route function before the end of attempts.
Time Out	When an ICMP echo reply was not received within the defined timeout.
Destination Invalid	With reserved IP addresses: For IPv4: 0.0.0.0, 127.0.0.0, and all addresses above 240.0.0.0 (Class E and above). For IPv6: 0::/8 (reserved/unspecified), 0::1/128 (Loopback), FF00::/8 (Multicast).
TTL Expired (ping test)	When the number of TTL was insufficient to reach the destination host.
Hop Reached (trace route test)	When a Time Exceeded message is received from a host while executing the trace route function.
Destination Unreachable	For IPv4: When the IP address is unreachable (no default gateway for an IP address, not in the same subnet, or an ICMP Unreachable message is received). For IPv6: When the IP address is unreachable (no default gateway for an IP address, not in the same subnet, or address resolution failed or an ICMP Destination Unreachable message is received).
Data Corrupted	Parameter problem message is received or data corruption is found for IPv4.
Discarded	Congestion has been detected and the request cannot be transmitted.
Packet Too Big	Packet Too Big message is received in response to a packet that the router cannot forward because the packet is larger than the MTU of the outgoing link. It is only applicable for the IPv6 version .
Undefined	For any other errors in ping/trace route that do not fall into one of the above description.

➤ **Replied Details**

For ping, indicates the IP address of the replier, the buffer size of the ICMP echo response, the time of response in milliseconds, and the TTL of the ICMP echo response.

For trace route, indicates the IP address of the replier, and the time of response in milliseconds.

Statistics

➤ **Packets Transmitted** indicates the number of sent packets.

➤ **Packets Received** indicates the number of received packets.

The following statistics are only available for the ping test.

➤ **Percentage Lost (%)** indicates the percentage of packets lost.

➤ **Min Round Trip Time (ms)** indicates the minimum time recorded for a ping request to be answered.

➤ **Max Round Trip Time (ms)** indicates the maximum time recorded for a ping request to be answered.

➤ **Avg. Round Trip Time (ms)** indicates the average time required for a ping request to be answered.

Pointer Adjustment

From the **Test** menu, tap **Functions**, and the **Pointer Adjustment** tab.

TX Pointer Adjustment

Note: *Only available in Coupled topology.*

The pointer adjustment supports two modes of operation: **Manual** and **Sequence**. Both modes offer the generation of pointer events even when the test is not started. The Sequence mode is only available for SONET/SDH BERT test application for rates up to OC-192/STM-64.

TX Pointer Adjustment - Manual Button

Step

➤ Value

For STS/AU: Select the number of positive (Increment) or negative (Decrement) pointer adjustments to include into the STS-n (SONET) or AU-n (SDH): **1** (default) to **1000**. For multiple pointer adjustments, the pointer adjustment rate is 1 adjustment at every 4 frames.

For VT/TU: Select the number of positive (Increment) or negative (Decrement) pointer adjustment to include into the VTn (SONET) or TU-n (SDH): **1** (default) to **1000**. For multiple pointer adjustments, the pointer adjustment rate is 1 adjustment at every 4 multiframes.

- **Increment** button sends the positive pointer adjustment defined.
- **Decrement** button sends the negative pointer adjustment defined.
- **Pointer Value** indicates the current pointer value.

Jump

- **New Pointer** allows selecting a new pointer value:

For STS/AU: **0** (default) to **782**

For VT/TU:

Path	Range
VT1.5	0 to 103
VT2	0 to 139
TU-3	0 to 764
TU-11	0 to 103
TU-12	0 to 139

- **Inject** button sends the new pointer value.
- **New Data Flag** (NDF) check box when selected inserts a New Data Flag with the pointer adjustment when the Inject button is tapped.

For STS/AU: When NDF is enabled, bits 1 to 4 of the pointer word (H1 and H2 bytes) are set to **1001** when executing a pointer jump.

For VT/TU: When NDF is enabled, bits 1 to 4 of the pointer word (V1 and V2 bytes) are set to **1001** when executing a pointer jump.

Test Functions

Pointer Adjustment

TX Pointer Adjustment - Sequence Button

Note: The pointer sequence is only supported on one test layer; either on VT/TU layer or on STS/AU when the test doesn't contain VT/TU mapping. The field next to the **Sequence** operation mode button indicates the path level used for the sequence pointer adjustment.

- **Sequence: T.105-03/GR-253** allows the selection of the pointer sequence pattern based on the **T.105-03/GR-253** standard.

Pointer Sequence Pattern	Available with
Single pointers of opposite polarity	AU-x, TU-3, TU-11, TU-12
Regular pointers plus one double pointer	AU-x, TU-3, TU-11, TU-12
Regular pointers with one missing pointer	AU-x, TU-3, TU-11, TU-12
Double pointers of opposite polarity	AU-x, TU-3, TU-11, TU-12
Single pointer adjustment	STS-x, VT1.5, VT2, AU-x, TU-3, TU-11, TU-12
Burst pointer adjustment	STS-x, VT1.5, VT2, AU-x, TU-3, TU-11, TU-12
Phase transient	STS-x, VT1.5, VT2, AU-x, TU-3, TU-11, TU-12
Periodic pointer adjustment 87-3 pattern	STS-x, AU-x, TU-3
Periodic 87-3 with Add	STS-x, AU-x, TU-3
Periodic 87-3 with Cancel	STS-x, AU-x, TU-3
Periodic pointer adjustment continuous	STS-x, VT1.5, VT2, AU-x, TU-3, TU-11, TU-12
Periodic pointer adjustment continuous with Add	STS-x, VT1.5, VT2, AU-x, TU-3, TU-11, TU-12
Periodic pointer adjustment continuous with Cancel	STS-x, VT1.5, VT2, AU-x, TU-3, TU-11, TU-12
Periodic pointer adjustment 26-1 pattern	VT1.5, TU-11
Periodic 26-1 with Add	VT1.5, TU-11
Periodic 26-1 with Cancel	VT1.5, TU-11

➤ **Initialization / Cool Down / Sequence**

The following time line examples show the initialization, cool down, and the pointer sequence according to the selected sequence and parameters.

Example 1: Periodic 87-3 with Cancel

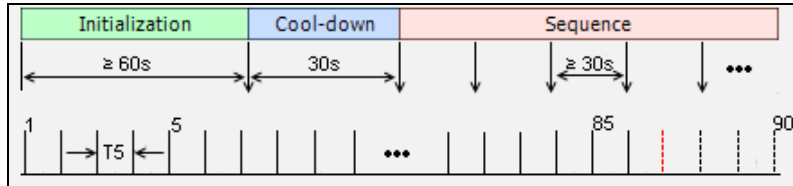

Example 2: Regular pointers plus one double pointer



Legend:

	Description
	When located at the end (right) of the sequence, indicates a continuous repetition of the pointer sequence. When located within the sequence, indicates a repetition of pointers.
	Regular pointer event or sequence.
	Cancel event.
	Special event like an extra cancel event (for example in Periodic 87-3 with Cancel) or a missing event from the Regular pointers with one missing pointer sequence.
	Special event like add, double pointer, etc.
	Indicates that the sequence is periodic with special event.

Test Functions

Pointer Adjustment

- **T1 to T6** are configurable duration parameters. The range of the duration parameters as well as their availability versus pointer sequence are described in the following table.

Pointer Sequence Pattern	Parameter	Duration range
Single pointers of opposite polarity	T1	10 to 30 s (default 10 s)
Regular pointers plus one double pointer	T2	AU/TU-3: 7.5 ms to 30 s (default 0.333 s) TU-11/12: 0.2 s to 30 s (default 0.75 s)
	T3	AU/TU-3: 0.5 ms TU-11/12: 2 ms
Regular pointers with one missing pointer	T2	AU/TU-3: 7.5 ms to 30 s (default 0.333 s) TU-11/12: 0.2 s to 30 s (default 0.75 s)
Double pointers of opposite polarity	T1	10 to 30 s (default 10 s)
	T3	STS-x/AU-x/TU-3: 0.5 ms to 1 s (default 0.5 ms) VT-x/TU-11/12: 2 ms to 1 s (default 2 ms)
Single pointer adjustment	T6	30 to 60 s (default 30 s)
Burst pointer adjustment	T4	STS-x/AU-x/TU-3: 0.5 ms VT-x/TU-11/12: 2ms
	T6	30 to 60 s (default 30 s)
Phase transient	T6	30 to 60 s (default 30 s)
Periodic pointer adjustment 87-3 pattern	T5	7.5 ms to 10 s (default 0.333 s)
Periodic 87-3 with Add	T4	0.5 ms
	T5	7.5 ms to 10 s (default 0.333 s)
Periodic 87-3 with Cancel	T5	7.5 ms to 10 s (default 0.333 s)
Periodic pointer adjustment continuous	T5	STS-x/AU-x/TU-3: 7.5 ms to 10 s (default 0.333 s) VT-x/TU-11/12: 0.2 s to 10s (default 1 s)
Periodic pointer adjustment continuous with Add	T4	STS-x/AU-x/TU-3: 0.5 ms VT-x/TU-11/12: 2 ms
	T5	STS-x/AU-x/TU-3: 7.5 ms to 10 s (default 0.333 s) VT-x/TU-11/12: 0.2 s to 10 s (default 1 s)
Periodic pointer adjustment continuous with Cancel	T5	STS-x/AU-x/TU-3: 7.5 ms to 10 s (default 0.333 s) VT-x/TU-11/12: 0.2 s to 10 s (default 1 s)
Periodic pointer adjustment 26-1 pattern	T5	0.2 s to 10 s (default 1 s)
Periodic 26-1 with Add	T4	2 ms
	T5	0.2 s to 10 s (default 1 s)
Periodic 26-1 with Cancel	T5	0.2 s to 10 s (default 1 s)

- **T1 (s)** represents the interval between two pointer events.

Example of **Single pointer of opposite polarity** sequence.

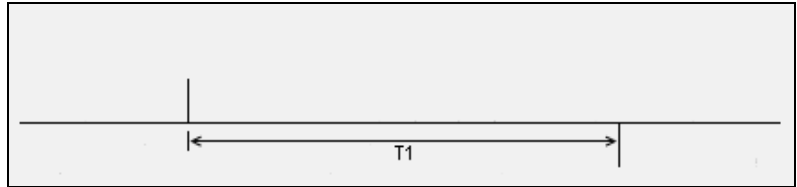

- **T2 (s)** represents the interval between successions of pointer events.

Example of **Regular pointers with one missing pointer** sequence.



- **T3 (ms)** represents the interval between back to back pointer events.

Example of **Regular pointers plus one double pointer** sequence.



Test Functions

Pointer Adjustment

- **T4 (ms)** represents the interval between back to back pointer events in periodic pointer sequence.

Example of **Burst pointer adjustment** sequence.

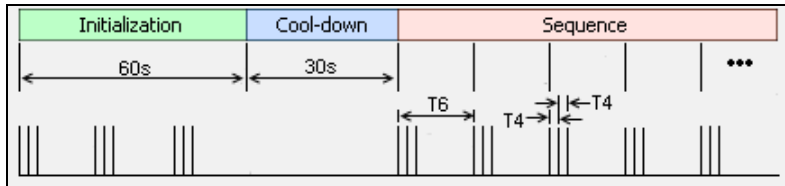

- **T5 (s)** represents the interval between successions of pointer events in a Periodic pointer sequence.

Example of **Periodic 87-3 with Cancel** sequence.

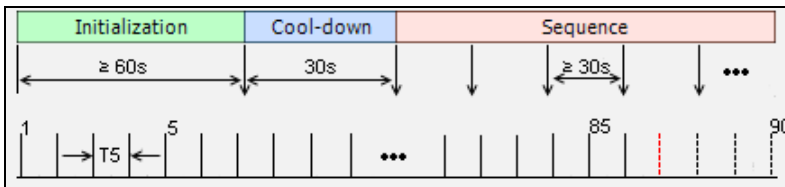

- **T6 (s)** represents the interval between successions of pointer events.

Example of **Phase transient** sequence.

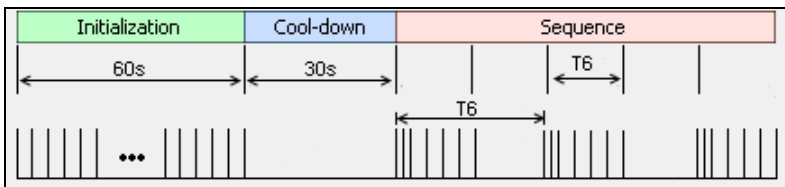

- **Increment/Decrement** allows determining if the pointer sequence will increment (positive) or decrement (negative) the pointer values.
- **Periodic** check box when selected, generates the pointer sequence continuously. The pointer sequence is generated only once when the **Periodic** check box is cleared. The capability to clear the **Periodic** check box is only available for the following pointer sequences:
 - Single pointers of opposite polarity
 - Regular pointers plus one double pointer
 - Regular pointers with one missing pointer
 - Double pointers of opposite polarity
- **Init-Cool** check box when selected, generates pointer action with three phases: initialization, Cool-down, and pointer sequence. Only the pointer sequence is generated when the **Init-Cool** check box is cleared.
- **Status** indicates the pointer event activity status.
 - **Initialization** indicates that the pointer sequence test is started and is running the initialization phase.
 - **Cool-down** indicates that the pointer sequence test is started and is running the cool down phase.
 - **Sequence** indicates that the pointer sequence test is started and is running the sequence phase; this phase runs until the Sequence is turn off.
 - **Static pointer** indicates that the pointer sequence is not started. The signal generator transmits a fix pointer value.
- **Pointer Value** indicates the current pointer value. Available even if the test is not started or if the sequence is not enabled.

Test Functions

Pointer Adjustment

- **Sequence** button when enabled, generates pointer events on a regular basis. The initialization and cool down sequence are described below for each pointer sequence pattern.

Pointer Sequence Pattern	Initialization	Cool down
Single pointers of opposite polarity	Basic sequence ^{ab} Duration ≥ 60 sec	Basic sequence ^{ab} Duration = 30 sec
Regular pointers plus one double pointer	Add sequence Duration ≥ 60 sec	Add sequence Duration = 30 sec
Regular pointers with one missing pointer	Cancel sequence Duration ≥ 60 sec	Cancel sequence Duration = 30 sec
Double pointers of opposite polarity	Basic sequence ^{ab} Duration ≥ 60 sec	Basic sequence ^{ab} Duration = 30 sec
Single pointer adjustment	One pointer event per second Duration = 60 sec	No pointer event Duration = 30 sec
Burst pointer adjustment		
Phase transient		
Periodic pointer adjustment 87-3 pattern	Basic sequence ^a Duration ≥ 60 sec	Basic sequence ^a Duration = 30 sec
Periodic 87-3 with Add		Add sequence Duration = 30 sec
Periodic 87-3 with Cancel		Cancel sequence Duration = 30 sec
Periodic pointer adjustment continuous	Basic sequence ^a Duration = 60 sec	Basic sequence ^a Duration = 30 sec
Periodic pointer adjustment continuous with Add		Add sequence Duration = 30 sec
Periodic pointer adjustment continuous with Cancel		Cancel sequence Duration = 30 sec
Periodic pointer adjustment 26-1 pattern	Basic sequence ^a Duration ≥ 60 sec	Basic sequence ^a Duration = 30 sec
Periodic 26-1 with Add		Add sequence Duration = 30 sec
Periodic 26-1 with Cancel		Cancel sequence Duration = 30 sec

- The basic sequence corresponds to the pointer event pattern defined in the standard without any Add or extra Cancel event.
- Only available when the **Periodic** check box is selected.

RX Pointer Adjustment

➤ Pointer Value

For STS/AU: Displays the value for the pointer, H1 and H2, indicating the offset in bytes between the pointer and the first byte of the STS-n (SONET) or AU-n (SDH).

For VT/TU: Displays the value of the pointer, V1 and V2, indicating the offset in bytes between the pointer and the first byte of the VTn (SONET) or TU-n (SDH) of the high order path. However, TU-3 considered a low order path, uses the H1, H2, H3 bytes for its location.

- **Cumulative Offset** indicates the difference between the pointer increment and the pointer decrement. A pointer jump will reset this value to **0**.
- **Ptr. Incr.** (Pointer Increment) gives statistics on positive pointer adjustment detected.
- **Ptr. Decr.** (Pointer Decrement) gives statistics on negative pointer adjustment detected.
- **NDF** (New Data Flag) gives statistics on pointer jumps containing a New Data Flag.

For STS/AU: Bits 1 to 4 of the pointer word (H1 and H2) detected are **1001**.

For VT/TU: Bits 1 to 4 of the pointer word (V1 and V2) detected are **1001**.

- **No NDF** (No New Data Flag) gives statistics on normal pointer jumps containing no NDF.

For STS/AU: Bit 1 to 4 of the pointer word (H1 and H2) detected are **0110**.

For VT/TU: Bit 1 to 4 of the pointer word (V1 and V2) detected are **0110**.

RTD

Note: *Available with Pattern client. Not available in Decoupled, Through, or Through Intrusive mode.*

Round Trip Delay (RTD) measurements are needed to quantify the time it takes for a signal to cross the network and come back. Usually, transport delay is due to two factors: long configured paths and transit times through the network elements along the path. Therefore, RTD measurements are significant in systems that require two-way interactive communication, such as voice telephony, or data systems where the round-trip time directly affects the throughput rate.

From the **Test** menu, tap **Functions**, and the **RTD** tab.

Note: *To do a Round Trip Delay test, the remote NE should be configured to provide a loopback.*

Note: *Be aware that RTD requires error free operation conditions to provide reliable results. Therefore, RTD results could be affected by error injection or error introduced by the network.*

Mode

Allows the selection of the round trip delay test mode. Choices are **Single** (default) and **Continuous**.

- **Single** allows testing the round trip delay once.
- **Continuous** allows testing the round trip delay continuously in a repetitive manner (one RTD measurement every 2 seconds).

Measure Delay Button

Allows enabling the round trip delay measurement.

For **Single** mode, the test is performed once and stops (the **Measure Delay** button turns off by itself). The **Measure Delay** button is only available when the test is running.

For **Continuous** mode, the test is performed continuously until the RTD test or the test case itself is stopped. However, the measurement will only start if the test is running or when it will be started. The **Measure Delay** button turns off by itself when the auto-calibration fails.

Note: *The Round Trip Delay (RTD) auto-calibration generates some bit errors when turning on the RTD measurement while the test is running or when starting the test while the **Measure Delay** button is enabled. A far end testing equipment will detect those bit errors.*

Status

Indicates the test status of the RTD test. The status is only available when the test case is running.

- **Ready** indicates that the last calibration sequence has been successful and the test is now ready to perform RTD measurement.
- **Running** indicates that the RTD test is running.
- **Cancelled** indicates that the RTD test has been stopped before its completion.
- **Calibration Failed** indicates that the test calibration failed due to at least one of the following conditions:
 - Internal errors.
 - Presence of high number of bit errors.

Therefore the RTD statistics becomes unavailable since the test does not allow RTD testing.

Test Functions

RTD

- **Disabled:** Indicates that the RTD feature is disabled.
- **--:** Indicates that the RTD measurement is not ready.

Reset

Resets the RTD results and measurement counts.

Delay

Indicates the time required for a bit to travel from the transmitter back to its receiver after crossing a far-end loopback.

- **Last** indicates the result of the last Round Trip Delay measurement.
- **Minimum** indicates the minimum Round Trip Delay recorded.
- **Maximum** indicates the maximum Round Trip Delay recorded.
- **Average** indicates the average Round Trip Delay value.
- **Unit** measurement selections are **ms** (default) and **μs**.

Count

Indicates the total number of successful and failed measurements.

Successful: A measurement is declared successful when the RTD is smaller or equal to 2 seconds.

Failed: A measurement is declared failed when the RTD is > 2 seconds.

RTD/RTT (CPRI/OBSAI Framed L2)

Note: Only available with CPRI/OBSAI Framed L2 in **Base Station** emulation mode.

Round Trip Delay (RTD for CPRI) and Round Trip Time (RTT for OBSAI) measurements are needed to quantify the time it takes for a signal to cross the remote radio head and come back.

Note: Be aware that RTD/RTT requires error free operation conditions to provide reliable results. Therefore, RTD/RTT results could be affected by error injection or error introduced by the network.

From the **Test** menu, tap **Functions**, and the **RTD/RTT** tab.

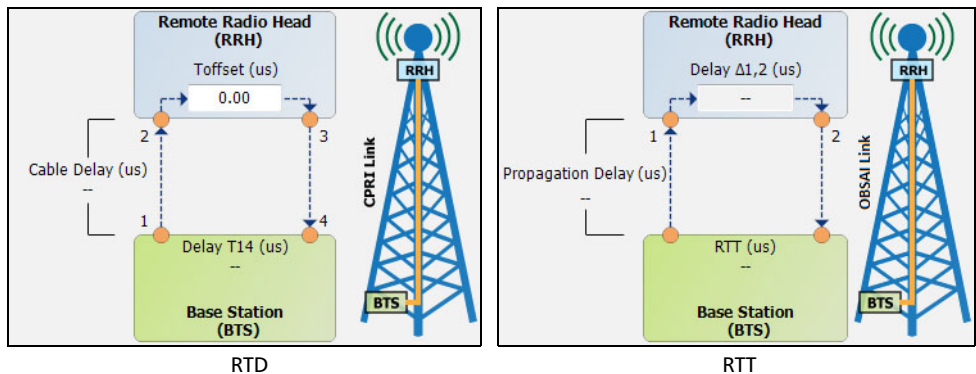

P1 and **P2** buttons, available with CPRI - **Dual Port** topology, allow selecting the port to be displayed.

Test Functions

RTD/RTT (CPRI/OBSAI Framed L2)

Round Trip Delay (CPRI)

Indicates the time required for a bit to travel from one point to another.

- **Delay T14** indicates the round trip delay measurement from the Base Station going through the Remote Radio Head (including **Toffset**) and back to the Base Station. The **Delay T14** appearing on the diagram corresponds to the average value.
- **Cable Delay** indicates the cable delay measured from the Base Station to the Remote Radio Head (RRH) or vice-versa assuming that the cabling in both directions are the same. The **Cable Delay** appearing on the diagram corresponds to the average value.
- **Last** indicates the result of the last delay measurement.
- **Minimum** indicates the minimum delay recorded.
- **Maximum** indicates the maximum delay recorded.
- **Average** indicates the average delay value.
- **Unit** measurement selections are **μs** (default) and **ns**.
- **Toffset** allows the configuration of the internal delay introduced by the electronic components in the Radio Equipment (RE): 0 μs (default) to 66.67 μs.

Note: A warning icon appears next to the **Toffset** value when this value is larger than the **Delay T14** value measured indicating that the **Toffset** configured value maybe invalid thus corrupting the **Cable Delay** values reported.

Round Trip Time (OBSAI)

Indicates the time required for a bit to travel from one point to another.

- **RTT** indicates the round trip time measurement from the Base Station going through the Remote Radio Head (including **Delay $\Delta_{1,2}$**) and back to the Base Station. The **RTT** appearing on the diagram corresponds to the average value.
- **Propagation Delay** indicates the propagation delay measured from the Base Station to the Remote Radio Head (RRH) or vice-versa assuming that the cabling in both directions are in the same cable bundle. The **Propagation Delay** appearing on the diagram corresponds to the average value.
- **Last** indicates the result of the last time/delay measurement.
- **Minimum** indicates the minimum time/delay recorded.
- **Maximum** indicates the maximum time/delay recorded.
- **Average** indicates the average time/delay value.
- **Unit** measurement selections are **μs** (default) and **ns**.
- **Delay $\Delta_{1,2}$** reports the internal delay introduced by the electronic components in the Remote Radio Head (RRH).

S-OAM Link Trace

From the **Test** menu, tap **Functions**, and the **S-OAM Link Trace** tab.

Link Trace

- **Priority**¹ allows selecting the VLAN user priority: **0** (default) to **7**. Refer to *VLAN ID and Priority* on page 758 for more information.
- **Drop Eligible**¹ is set to **No** (no frames will be dropped when congestion occurs) and is not configurable.
- **TTL** sets the Time To Live value: **1** to **255** (default is **128**).
- **Link Trace** button when ON (OFF by default) starts the link trace process. The **Link Trace** button turn OFF automatically once the link trace process is completed.

Result

The table reports the following information for each valid LTR frames received in response to the last LTM frame sent: **TTL**, **MEP/MIP MAC Address**, **Forward**, and **Term MEP**.

- **Last Link Trace Status** displays the last link trace status.

Status	Description
Pending	No Results
Successful	Last Link Trace was successful
Failed – LTR Timeout	Last Link Trace failed due to a LTR Timeout
Failed – Invalid LTR	Last Link Trace failed due to an Invalid LTR

- **TX LTM** indicates the count of transmitted LTM frames.

1. Available when VLAN is enabled (see *VLAN* on page 225).

- **RX LTR** indicates the count of received LTR frames having their destination MAC address matching the unit port MAC address, and VLANs matching the unit port VLANs.
- **LTR Timeout** indicates the count of LTR Timeout event which occurs if a reply (LTR) from the Peer MEP is not received within 5 seconds.
- **Invalid LTR** indicates the count of LTR frames received with incorrect MEG/MD Level or Transaction ID.

Test Functions

Signaling Bits

Signaling Bits

Allows generation and monitoring of the signaling bits. Only available for DS_n/PDH BERT framed test with DS0/E0 enabled.

From the **Test** menu, tap **Functions** and the **Signaling Bits** tab.

Note: *Two signaling bits (AB) are available for SF or SLC-96 framing while four signaling bits (ABCD) are available for ESF.*

TX Signaling

Note: *Only available when TX Signaling is enabled (refer to TX Signaling on page 295).*

- **Signaling Mode**, available with DS0, is configurable to **2/4/16 States** for ESF or **2/4 States** for SF/ SLC-96; default is **4 States**.

Signaling Mode	2-States		4-States		16-States
	SF/SLC-96	ESF	SF/SLC-96	ESF	ESF
Signaling Bits	00 11 ^a	0000 1111 ^a	00 to 11 ^a	0000 0101 1010 1111 ^a	0000 to 1111 ^a

a. Default value.

- **Channel/AB/ABCD** table: Allows the configuration of signaling bits of either the 24 - DS0 channels or 30 - E0 channels.

Note: *Channel numbers for E0 refer to telephone channel numbers. Timeslots 1 to 15 and 17 to 31 are assigned to telephone channels numbered from 1 to 30 as per G.704.*

RX Signaling

Channel/AB/ABCD table: The monitoring of signaling bits of either the 24 - DS0 channels or 30 - E0 channels is performed when the test is running.

Spare Bits

Note: *Spare Bits are not available when the framing is set to **Unframed**.*

From the **Test** menu, tap **Functions**, tap the **Spare Bits** tab.

TX

Tap a spare bits field to set its value.

Note: *All spare bits are reserved for national use and should be set to 1 when not used.*

➤ E4

G.751 Bit 14, 15, 16: Choices are **000** to **111** (default).

➤ E3

G.751 Bit 12: Choices are **0** and **1** (default).

➤ E1

- **S_{i0}** is located in the bit 1 of the frame containing the frame alignment signal (FAS). Choices are **0** and **1** (default).
- **S_{i1}** is located in the bit 1 of the frame not containing the frame alignment signal (FAS). Choices are **0** and **1** (default).
- **S_{a4}** to **S_{a8}** are located in bit 4 to 8 of frame number 1, 3, 5, and 7 of sub-multiframe 1 and 2. Choices are **0** and **1** (default) or **0000** to **1111** (default) depending on the selected framing.
- **TS16 Frame 0 Bit 5, 7, 8** are located in bit 5, 7, and 8 from Timeslot 16 of frame 0 of a E1 signal. Choices are **000** to **111** (default).

RX

➤ E4

G.751 Bit 14, 15, 16 are reserved for national use.

➤ E3

G.751 Bit 12 is reserved for national use.

➤ E2

G.742 Bit 12 represents Bit 12 from Timeslot 1, 2, 3, and 4 respectively.

➤ E1

➤ **S_{i0}** is located in the bit 1 of the frame containing the frame alignment signal (FAS).

➤ **S_{i1}** is located in the bit 1 of the frame not containing the frame alignment signal (FAS).

➤ **S_{a4} to S_{a8}** are located in bit 4 to 8 of frame number 1, 3, 5, and 7 of sub-multiframe 1 and 2. Possible values are either **0** and **1** or **0000** to **1111** depending on the framing.

➤ **TS16 Frame 0 Bit 5, 7, 8** are located in bit 5, 7, and 8 from Timeslot 16 of frame 0 of a E1 signal.

Test Functions

Traffic Scan

Traffic Scan

The traffic scan tool provides the capability to discover and monitor VLAN traffic flows on the network.

Note: *Not available with dual port test and when **Provider Encapsulation** is used.*

From the **Test** menu, tap **Functions**, and the **Traffic Scan** tab.

Level

Allows the selection of the criteria that will be used to filter the incoming VLAN traffic flows. The default setting is **All**. Choices are:

Level	Description
All	Monitors untagged frames and up to 3 levels of stacked VLAN frames
Untagged	Monitors untagged frames only (no VLAN)
C-VLAN	Discovers/monitors only frames where the outer VLAN is a C-VLAN (TPID of 0x8100)
S-VLAN	Discovers/monitors only frames where the outer VLAN is a S-VLAN (TPID of 0x8100, 0x88A8, 0x9100, 0x9200, or 0x9300)
E-VLAN	Discovers/monitors only frames where the outer VLAN is a E-VLAN (TPID of 0x8100, 0x88A8, 0x9100, 0x9200, or 0x9300)

Rate Layer

Allows the selection of the rate unit used for **Link Rate** and **Rate** statistics.

- **Line Utilization** is used to express the real line rate including the Preamble, SFD, and IFG.
- **Ethernet BW** (Bandwidth) is used to express the Ethernet bandwidth rate excluding the Preamble, SFD, and IFG.

Discovered

Indicates the number of different traffic flows monitored based on the scan criteria.

Link Rate (Mbit/s)

Indicates the network link rate based on the received frames with a valid FCS regardless if the frame matches or not the traffic flows, and regardless if the traffic flow was ignored due to the limit reached (see *Limit Reached*). The rate is expressed either in **Line Utilization** or **Ethernet Bandwidth** depending on the **Rate Layer** selected.

Limit Reached

Up to 128 different traffic flows can be monitored, the **Limit Reached** text appears with a red background next to the **Discovered** field when the limit is reached.

Scan

Starts/stops the traffic scan test.

Test Functions

Traffic Scan

Monitored Frames Table

Statistics are gathered for each different traffic flow matching the scan criteria. Each different monitored traffic flow creates a separate entry in the scan table. When the limit is reached, new traffic flows are not considered in the table but the existing traffic flows are still monitored.

The level of VLAN (untagged, E-VLAN, S-VLAN, C-VLAN), and values of VLAN ID, Priority, and TPID are used to identify a traffic flow. Any difference in one of these values will create a separated entry in the table. PBB-TE frames are ignored.

Note: *Scan statistics are cleared when restarting the scan.*

➤ **E-VLAN / S-VLAN / C-VLAN**

- **ID** indicates the VLAN ID of the received traffic flow.
- **Priority** indicates the VLAN Priority of the received traffic flow.

Note: *The TPID indicating the Tag Protocol Identifier of the received traffic flow is reported in the test report.*

➤ **Statistics**

- **Frame Count** indicates for each traffic flow, the number of frames matching the selected scan criteria.

Total indicates the total number of frames matching the selected scan criteria.

- **Rate (Mbit/s)** indicates for each traffic flow, the rate of frames matching the selected scan criteria. The rate is expressed either in **Line Utilization** or **Ethernet Bandwidth** (see *Rate Layer*).

Total indicates the total rate of frames matching the selected scan criteria.

11 Test Control

This chapter describes the test control buttons available on the right navigation bar of the application.

Button	For more information, see:
Discover Remote	Discover Remote Button <i>on page 636</i>
Inject	Inject Button <i>on page 639</i>
Laser	Laser Button <i>on page 639</i>
Lpbk Tool	Lpbk Tool Button (Loopback Tool) <i>on page 640</i>
Report	Report Button <i>on page 647</i>
Reset	Reset Button <i>on page 652</i>
Save/Load	Save/Load Button <i>on page 653</i>
Start/Stop TX	Start/Stop TX Button <i>on page 657</i>

Discover Remote Button

The Discover Remote function allows performing Ethernet tests in conjunction with a second test set (module) by scanning and connecting to any available EXFO Datacom remote module. The remote module is used to loop back the traffic via Smart Loopback or **Dual Test Set (DTS)** for simultaneous bidirectional RFC 2544, RFC 6349, or EtherSAM results.

Note: *Only available with **EtherSAM**, **EtherBERT**, **RFC 2544**, **RFC 6349**, and **Traffic Gen & Mon** test applications.*

Remote Modules Discovery

- **Target** defines how to perform the scan to discover remote modules.
 - **Subnet** indicates to perform the scan based on the current subnet.
 - **Specific IP** indicates to perform the scan for a specific remote module IP address. Enter the IP address of the target module.
 - **Quick Ping** tests if the destination IP address can be reached. A message displays if the ping attempt is **Successful** or **Failed**.
- **Scan** button scans the subnet or a specific IP (see **Target**) to discover remote EXFO compatible module(s).

The discovered modules are listed in the table with their **IP Address**, **Remote ID**, **Capabilities**, and **Status** information. **Remote ID**, **Capabilities**, and **Status** are only available for remote 88000 Series, and 85100G modules.

- **Capabilities** indicates the loopback capabilities of the remote module using the following test application icons:
Smart Loopback, RFC 2544, RFC 6349, and/or EtherSAM.

- **Status** indicates the status of the remote module.

Status	Description
Idle -<test application> ^a	The specified test application is selected but not running.
Busy -<test application> ^b	The specified test application is running.
Not Responding	No response from the specified IP address (only possible when Target is set to Specific IP).

- a. Possible test applications: EtherSAM, RFC 2544, RFC 6349, EtherBERT, Traffic Gen & Mon, Smart Loopback, Through Mode, TCP Throughput, Carrier Ethernet OAM, Cable Test, 1588 PTP, or SyncE.
- b. Possible test applications: EtherSAM, RFC 2544, RFC 6349, EtherBERT, Traffic Gen & Mon, Smart Loopback, TCP Throughput, Carrier Ethernet OAM, 1588 PTP, or SyncE.

- **Loop Up** and **Loop Down** buttons (Not available with RFC 6349 test application)

- **Loop Up** establishes the connection with the selected remote module and sets the remote module into **Smart Loopback** test application.

If a remote module is in any busy status a user confirmation is required to proceed with the Loop Up command.

Following a successful loop up, the IP address of the remote module will be used as the destination IP address for the test.

Once the connection is established with the remote module, the local module can be set for EtherSAM, RFC 2544, EtherBERT, or Traffic Gen & Mon testing.

- **Loop Down** ends the connection between the local and the remote modules.

Test Control

Discover Remote Button

- **Connect** and **Disconnect** buttons are only available with RFC 2544, RFC 6349, and EtherSAM test applications.
 - **Connect** establishes the connection with the selected remote module and sets the remote module into either DTS RFC 2544, DTS RFC 6349, or DTS EtherSAM test application, depending on the active test on the local module.

If a remote module is in any busy status a user confirmation is required to proceed with the Loop Up command.

Following a successful connection, the IP address of the remote module will be used as the destination IP address for the test.
 - **Disconnect** ends the connection between the local and the remote modules.

Local Module Identification



Module ID is used to easily identify this module in case another module is performing a discovery scan. Up to 16 alpha-numeric characters are allowed.

Inject Button

Injects alarms/errors based on settings from the *Inject Button* on page 413.

Laser Button

The **Laser** button enables or disables the laser for optical interfaces. For **Dual Port** topology, enables or disables the laser for both optical interfaces (ports). However, when an active copper SFP is used on a port, the laser is always on for this port.

Laser Button	Border Color	Description
	Black	Laser is off.
	Red	Laser is on.

Test Control

Lpbk Tool Button (Loopback Tool)

Lpbk Tool Button (Loopback Tool)

The Loopback Tool provides the capability of looping back the Ethernet frames/packets that are received on the loopback tool port.

Pressing the **Lpbk Tool** button opens the Loopback Tool pop-up and powers up the port unused by the main test application (it does not start looping back the frames yet). The Loopback Tool starts looping back the Ethernet frames/packets that are received when pressing on the **Loopback** button from the **Loopback Tool** tab.

Note: *The **Lpbk Tool** button is available when the main test application is any single port Ethernet test application (up to 10G WAN rate) with the exception of Through mode. Not available on 88200NGE.*

Note: *The Loopback Tool is independent from the main test **Start/Stop**, **Reset** and **Test Timer**.*

Note: *Enabling/disabling the Laser control affects both the main test application and the Loopback Tool when applicable (if both test and tool are using an optical port).*

Loopback Tool tab

The **Loopback Tool** tab allows the configuration of the loopback parameters and displays the traffic statistics as well as the S-OAM Responder statistics.

Press the **Lpbk Tool** button and select the **Loopback Tool** tab.

- **Status:** The status field displays the current status of the Loopback test.
 - **-- (Idle):** Loopback Tool is not looping back frames and results are not available.
 - **In Progress:** Loopback Tool is looping back frames.
 - **Completed:** Loopback Tool is not looping back frames but results are available. The test **Status** indicates **Completed** when the loopback tool has been stopped.
- **Start Time:** The time when the Loopback Tool was started.
- **Transparent (Pseudo-Physical)** check box when selected (cleared by default), determines that the Loopback tool operates as a physical loopback by transmitting all received frames unaltered and without discrimination.

In transparent mode, the Network tab and the S-OAM Responder statistics are not available.

Note: *The **Transparent** mode is intended to be used for point-to-point topology, not for switched or routed networks. Use the **Transparent** mode with caution because all received frames are looped back without discrimination.*

Test Control

Lpbk Tool Button (Loopback Tool)

- **Loopback Mode** determines at which layer the address/port swapping is limited.
 - **Ethernet** swaps the MAC addresses of received packets having their **Destination MAC** address matching the MAC address of the loopback port.
 - **Ethernet (All Unicast)** swaps the MAC addresses of received packets having Unicast **Destination MAC** address.
 - **IP**, for Ethernet Layer 3 and 4, swaps the MAC and IP addresses of received packets having their **Destination IP** address matching the IP address of the loopback port. For Ethernet Layer 2, swaps the **MAC addresses** for packets having their **Destination MAC** address matching the MAC address of the loopback port.
 - **UDP/TCP** (default), for Ethernet Layer 4, swaps the UDP or TCP ports and the MAC and IP addresses of received packets having their **Destination IP** address matching the IP address of the loopback port. For Ethernet Layer 3, swaps the MAC and IP addresses for packets having their **Destination IP** address matching the IP address of the loopback port. For Ethernet Layer 2, swaps the **MAC addresses** for packets having their **Destination MAC** address matching the MAC address of the loopback port.
- **Traffic**
 - **Line Utilization (%)** indicates the current percentage of the transmitting/receiving line rate utilization.
 - **Ethernet BW (Mbit/s)** indicates the current transmitting/receiving data rate expressed in Mbit/s.
 - **Frame Rate (frame/s)** indicates the current transmitted/received number of frames (including bad frames, Broadcast frames and Multicast frames) in frame per second.
 - **Frame Count** indicates the total number of transmitted/received valid and invalid frames.

- **S-OAM Responder** check box when selected (default) allows responding to LBM, LTM, DMM, LMM, and SLM valid messages (**Lpbk Tool** must be started, see **Loopback** button below). Traffic statistics are also monitored (refer to *Responder* on page 535).

Responds to... message	Responds with... message
LBM	LBR
LTM	LTR
DMM	DMR
LMM	LMR
SLM	SLR

Responder - TX Count reports respectively the count of LBR, LTR, DMR, LMR, SLR, and the total of frames transmitted.

Responder - RX Count reports counts of valid LBM, LTM, DMM, LMM, SLM, and the total of frames received. A valid messages must have its destination MAC address matching either the unit port Unicast MAC address or a Multicast class 1 address¹.

- **Loopback** button starts/stops looping back the frames/packets that are received. The default value is disabled.

1. Refer to *Unicast/Multicast Addresses for Ethernet OAM* on page 757 for more information.

Test Control

Lpbk Tool Button (Loopback Tool)

Interface Tab

➤ Physical Interface

- **Interface/Rate** allows the selection of the loopback tool interface rate: **10/100/1000M Electrical** (default), **100M Optical**, **1GE Optical**, or **10GE LAN**. **10GE LAN** is only available when the loopback tool runs on Port #1.
- **Connector** displays the module's port for the selected interface/rate.

Interface/Rate	Connector	
	When using Port 1	When using Port 2
10GE LAN	Port 1 - SFP+	Port 2 - SFP+
1GE Optical 100M Optical	Port 1 - SFP/SFP+	Port 2 - SFP+
10/100/1000M Electrical	Port 1 - RJ45	Port 2 - SFP+ (RJ45) ^a

a. Ethernet 10/100/1000M electrical is supported when using an active copper SFP.

- **Clock Mode:** Displays the clock mode
 - Internal:** Internal clock of the unit (STRATUM 3).
 - Recovered:** Line clock from the input port signal involved in the tool.
- **RX Power (dBm)** indicates the current received power level of the optical laser in dBm.
 - Green: Power level in range.
 - Yellow: Power level out-of-range.
 - Red: Loss of signal or power level is close to damage.
 - Gray: Invalid operational range value or not supported by the optical transceiver.

- **Power Range (dBm)** indicates, when supported, the received power level range of the optical laser in dBm.
- **RX Frequency (MHz/GHz)** indicates the frequency of the input signal. When no frequency reading is possible, "--" is displayed. Not available when using an active copper SFP.
- **LINK**
 - **Auto-Negotiation** check box when selected, enables the link auto-negotiation and allows setting the port **Speed**, **Duplex**, **Flow Control**, and **Local Clock** parameters. Those settings are not applied immediately to the port, they are used only when the negotiation process is started and take effect only when the auto-negotiation succeeds. However current settings are applied immediately to the port when the **Auto-Negotiation** check box is cleared. The **Auto-Negotiation** check box is automatically selected for 1GE Electrical interface and is not configurable. Available with **10/100/1000M Electrical** interface.
 - **Speed**, available with **10/100/1000M Electrical** interface, allows the selection of the interface rate: **10M**, **100M**, **1GE**, or **Auto**¹. The negotiated speed will be displayed next to the **Speed** field selection.
 - **Duplex** choices for **10M** and **100M** electrical interfaces are **Full Duplex** (default), **Half Duplex**, and **Auto**¹. For other rates the Duplex is set to **Full Duplex**. The negotiated duplex will be displayed next to the **Duplex** field selection.
 - **Flow Control** choices are **TX**, **RX**, **RX and TX**, **None** (default), and **Auto**¹. When the **Flow Control** is set to **None**, pause frames received are ignored.

1. **Auto** is only available when the **Auto-Negotiation** check box is selected.

Test Control

Lpbk Tool Button (Loopback Tool)

- ▶ **Cable Mode** is available with **10/100/1000M Electrical** interface.
Manual mode is selected when the **Auto-Negotiation** check box is cleared and allows selecting the type of cable: **MDI** (default) for straight through cable or **MDIX** for crossover cable.
Automatic mode is selected when the **Auto-Negotiation** check box is selected and allows detecting automatically the MDI or MDIX cable type.
- ▶ **Local Clock** is only available with 1GE electrical interface and allows setting the provenance of the clock: **Master** (default), or **Slave**, or **Auto**¹.

Network tab

Refer to *Network* on page 220 for more information.

SFP/SFP+ tab

Refer to *CFP4/CFP8/QSFP/SFP/SFP+/SFP28* on page 147 for more information.

1. **Auto** is only available when the **Auto-Negotiation** check box is selected.

Report Button

The report contains all information about the current test including its setup and results.

Note: *Nothing prevents the configuration and alarm/error injection setup while the test has been stopped; thus, the report should be saved/printed before changing any test parameters to avoid printing discrepancy between the configuration and results.*

The **Report** button is available when the test is running or stopped, but the report generation is only possible when the test is stopped. It is possible to save, open, import, export, and delete test report(s).

File Location

➤ **Public Documents:**

Users\Public\Documents\88000-PowerBlazer\Reports

➤ **My Documents:**

Users\

➤ **Others**, use **Browse** to select a specific file location that will be displayed under **Others**.

➤ **Removable Drives** is only available when there is a removable disk/key connected to the platform USB port.

Config/Save Tab

The **Config/Save** tab allows configuring the report parameters and generating/saving the report.

Tap the **Report** button and the **Config/Save** tab.

- **Job Information** parameters, not mandatory, are used to identify the source of the report. Enter the following job information if required: **Job ID**, **Contractor Name**, **Customer Name**, **Operator Name**, **Circuit ID**, and **Comment**. Up to 30 characters are allowed for each parameter at the exception of **Comment** for which 256 characters are allowed.

Note: *When the **EXFO Connect Server** check box is selected in **EXFO Connect Client**, the **Operator Name** is not editable but can be selected from the **EXFO Connect** operator list using the **Change** button.*

Restore Default reverts all **Job Information** parameters back to the default values.

- **Report Headlines and Content** parameters are used to identify the report and are not mandatory. Up to 30 characters are allowed for each parameter.
 - **Report Header** could be the company name.
 - **Report Title** could be the name of the product, name of test, test number, etc.
 - **Optional Content** allows choosing the optional content that can be part of the report:
 - All** (default) includes all optional content to the report.
 - None** excluded all optional content from the report.
 - Custom** allows selecting the optional content to be part of the report.
 - **Choose Content**, available when the **Optional Content** is set to **Custom**, allows selecting what will be part of the custom content.

➤ **Save Report**

- **Auto-Generate File Name** check box, when selected (default), automatically generates the report file name which contains the name of the test, the date (YY.MM.DD), and time (HH.MM.SS). Clear the **Auto-Generate File Name** check box to enter a specific file name.

File Name is the name of the report to be generated.

- **Save To** is the file location where the report file will be saved (see *File Location* on page 647).
- **Display Report after Saving** check box when selected (default) automatically displays the report once it is generated.

Note: *Once generated, the report can be opened from the Open Tab on page 650.*

- **Turn on Report Generation Prompt** check box when selected (default) displays a pop-up every time a test case is stopped or completed to ask if a report generation is desired.
- **Format** is the file format for the report: **PDF** (default), **HTML**, and **Text**.
- **Logo** check box when selected (default) allows including a logo to the report. Only available with the PDF and HTML file format. Select the logo picture that will be displayed on the report.
- To select another logo, first add a new logo by either copying the logo picture file to the following folder or by using the Import/Export (see page 651) then select the new logo from the list.
Documents\88000-PowerBlazer\Reports\Images
Supported picture file formats are jpg, gif, bmp, and png.
- **Save Report** button generates and saves the report on the selected media (**Save to**).

Open Tab

Report files can be opened from this page.

Tap the **Report** button and the **Open** tab.

To open a saved report:

- 1.** Select the file location (see *File Location* on page 647).
- 2.** Select the report file from the list.
- 3.** Tap the **Open** button.

Import/Export Tab

Allows transferring and deleting report files from an external USB media. Also allows importing images that can be used as the Logo for reports.

Tap the **Report** button and select the **Import/Export** tab.

To import/export a report or image:

1. Select either **Report** or **Image** as **File Type**.
2. Select the file location (see *File Location* on page 647).
3. From the **Copy To** drop list, select where the file(s) will be copied.
4. Select the file(s) to be copied by selecting its corresponding check box or tap the **(Un)Select All** button to select or unselect all files in the list.
5. Tap the **Copy** button.
6. A confirmation is displayed, tap **OK**.

To delete a report or image:

1. Select either **Report** or **Image** as **File Type**.
2. Select the file location (see *File Location* on page 647).
3. Select the file(s) to be deleted by selecting its corresponding check box or tap the **(Un)Select All** button to select or unselect all files.
4. Tap the **Delete** button.
5. Tap **YES** to confirm the deletion.

Reset Button

Tap the **Reset** button to clear results, statistics, and logger content. The **Reset** button is only available when the test is running.

Note: *The **Reset** button is not available for EtherSAM, RFC 2544, RFC 6349, Cable Test, and Smart Loopback test applications.*

Save/Load Button

The **Save/Load** button allows saving, loading, importing, exporting, and deleting configuration file(s).

Note: *Save/Load is only possible when the test is stopped.*

File location

- **My Documents** offers two file locations: use **Favorites** for most commonly used configuration files or **Configurations** for others.

Users\<<User>\Documents\88000-PowerBlazer\Configuration
Users\<<User>\Documents\88000-PowerBlazer\Configuration\Favorites

- **Public Documents** offers two file locations: use **Favorites** for most commonly used configuration files or **Configurations** for others.

Users\Public\Documents\88000-PowerBlazer\Configuration
Users\Public\Documents\88000-PowerBlazer\Configuration\Favorites

- **Others** offers two file locations: use **Factory Defined** for factory defined configuration files or select **Browse** to create a user defined file location.
- **Removable Drives** is only available when there is a removable disk/key connected to the platform USB port.

Save/Load Tab

Tap the **Save/Load** button and the **Save/Load** tab.

The save function stores the configuration of the module including all test settings to a file.

To save a configuration:

1. Select the file location (see *File location* on page 653).
2. Tap on the **Save** button.
3. Type the name of the configuration file to be saved and a description (**Config Summary**) if needed.
4. Select the **Add to Favorites** check box to save the configuration file in the **Favorites** list.
5. Tap **OK**.

The load function opens and applies the test configuration from a previously saved configuration file.

To load a configuration:

1. Select the file location (see *File location* on page 653).
2. Select the file from the list.
3. Select or clear the **Overwrite report settings** check box as required. The **Overwrite report settings** check box when selected (default) replaces the current report settings by those from the configuration that is loaded.
4. Tap the **Load** button.

Note: *Configuration file has a limited backward compatibility. (Typically the backward compatibility period is one year or three software releases.)*

To rename a configuration file:

1. Select the file location (see *File location* on page 653).
2. Select the file from the list.
3. Tap the **Rename** button.
4. Change the name of the configuration file.
5. Select the **Add to Favorites** check box to save the configuration file in the **Favorites** list.
6. Tap **OK**.

To delete a configuration file:

1. Select the file location (see *File location* on page 653).
2. Select the file from the list.
3. Tap the **Delete** button.
4. Tap **Yes** to confirm the deletion.

To add a configuration file to the Favorites list:

1. Select **Configuration** from either **My Documents** or **Public Documents**.
2. Select the file from the list.
3. Tap the **Add to Favorites** button. The file will be moved into the **Configurations** folder of its corresponding location (either **My Documents** or **Public Documents**).

To remove a configuration file from the Favorites list:

1. Select **Favorites** from either **My Documents** or **Public Documents**.
2. Select the file from the list.
3. Tap the **Remove from Favorites** button. The file will be moved into the **Configurations** folder of its corresponding location (either **My Documents** or **Public Documents**).

Import/Export Tab

Configuration files can be transferred to and from an external USB media as well as deleted.

Tap the **Save/Load** button and the **Import/Export** tab.

To import/export a test configuration:

1. Select the source file location (see *File location* on page 653).
2. From the **Copy To** drop list, select a destination file location.
3. Select the file(s) to be copied by selecting its corresponding check box or tap the **(Un)Select All** button to select or unselect all files in the list.
4. Tap the **Copy** button.
5. A confirmation is displayed, tap **OK**.

To delete a test configuration:

1. Select the file location (see *File location* on page 653).
2. Select the file(s) to be deleted by selecting its corresponding check box or tap the **(Un)Select All** button to select or unselect all files in the list.
3. Tap the **Delete** button.
4. Tap **YES** to confirm the deletion.

Start/Stop | TX Button

The **Start/Stop | TX** button allows starting or stopping manually any test as well as enabling traffic generation (Traffic Gen & Mon).

To start the test:

Tap the **Start** button to start the test. **Start** is available when the test is not running.

To stop the test:

Tap the **Stop** button to stop the test; the traffic generation (Traffic Gen & Mon) also stops if it was enabled (TX button). **Stop** is available when the test is running.

By default, a message is displayed when the test stops asking to generate a report. To disable this feature, see *Turn on Report Generation* on page 649. Nothing prevents the configuration and alarm/error injection setup while the test has been stopped; thus, if a report is required, it should be saved before changing any test parameters to avoid discrepancy between the configuration and results. See *Report Button* on page 647 to generate and save a report file.

To enable traffic generation (available with Traffic Gen & Mon):

Tap the **TX** button to enable traffic generation for all enabled streams; the test is also started if it was not running. While the test is running the **TX** button is available to enable/disable traffic generation. Some conditions, such as ARP not resolved, link down, etc., may prevent the stream to be transmitted.

12 Power Failure Recovery

The automatic power failure recovery is used to select, configure, and restart¹ the test that was running before the power failure; a test that was not running will be selected and configured but not started. To provide this level of protection, the configuration of the current test is automatically saved; the logger, injections, and configuration are periodically saved.

A power failure occurs when the AC power is down (LTB-8 and FTB) while the unit's battery (FTB) has not sufficient power to keep the unit running. Pressing the platform power button for 5 seconds performs a power down reset and is also considered as a power failure condition. The Windows **Hibernate** or **Sleep** mode is also considered as a power failure condition.

When the power returns, the automatic power failure recovery restarts the platform, the module, then selects, configures, and starts the test if it was running before the power failure.

Note: *If the automatic power failure recovery is not used, restarting the module after a power failure automatically selects, configures, and starts the test if it was running before the power failure.*

1. Not applicable for iSAM, EtherSAM, RFC 2544, RFC 6349, TCP Throughput, and Cable Test applications; these tests must be started manually.

Enabling Power Failure Recovery

To enable the automatic power failure recovery:

1. Enable launching the application when starting the platform (refer to the platform user guide for more information):

From ToolBox X, tap on the **System Settings** button, the **Startup Applications** button, and select the corresponding module's check box.

2. Enable the platform automatic power on feature (refer to the platform user guide for more information):

2a. From ToolBox X, tap on the **System Settings** button and the **ToolBox X** button.

2b. Select the **Power on the unit when AC outlet is connected or after power outage** check box.

3. Make sure that Windows does not require a user name and password. The platform is set to require user name and password by default. To disable Windows user name and password:

3a. From ToolBox X, tap on the **System Settings** button and the **Automatic Logon** button.

3b. Clear the **User must enter a user name and password to use this computer** check box and enter the password to confirm.

Note: *The power failure recovery is not used when the application closes normally.*

When Using the Test Timer

Refer to *Timer* on page 330 for more information on test timer.

The test that was running will be re-created and started after a power failure if conditions described above are met in addition with the following test time conditions:

- The start time has not expired during the power failure.
- The stop time or the duration has not expired during the power failure.

13 *Maintenance*

To help ensure long, trouble-free operation:

- Always inspect fiber-optic connectors before using them and clean them if necessary.
- Keep the unit free of dust.
- Clean the unit casing and front panel with a cloth slightly dampened with water.
- Store unit at room temperature in a clean and dry area. Keep the unit out of direct sunlight.
- Avoid high humidity or significant temperature fluctuations.
- Avoid unnecessary shocks and vibrations.
- If any liquids are spilled on or into the unit, turn off the power immediately, disconnect from any external power source, remove the batteries and let the unit dry completely.



WARNING

The use of controls, adjustments and procedures, namely for operation and maintenance, other than those specified herein may result in hazardous radiation exposure or impair the protection provided by this unit.

Maintenance

Cleaning LC/SC/MPO-24 Connectors

Cleaning LC/SC/MPO-24 Connectors

Under normal circumstances the cleaning of the LC/SC/MPO-24 connector is not required. However if the connector shows signs of debris or contamination, cleaning may be required.

To clean a LC/SC/MPO-24 connector

1. Use a clean dry air (CDA) or a air gun to blow out the dust or contamination.
2. Re-inspect the connector. For MPO-24 optical connector, re-inspect the connector under magnification to make sure that it is clean.
3. If the connector is still not clean, use a commercial cleaner recommended by the transceiver manufacturer.

Note: Refer to the transceiver manufacturer for more detailed cleaning recommendations and instructions.

Battery Safety Information

The TA-... modules contain a battery for the insertion counter. If the battery status is low, contact your nearest authorized EXFO service center for its replacement.



WARNING

Do not throw batteries into fire or water and do not short-circuit the batteries' electrical contacts. Do not disassemble.

Recalibrating the Unit

EXFO manufacturing and service center calibrations are based on the ISO/IEC 17025 standard (*General Requirements for the Competence of Testing and Calibration Laboratories*). This standard states that calibration documents must not contain a calibration interval and that the user is responsible for determining the re-calibration date according to the actual use of the instrument.

The validity of specifications depends on operating conditions. For example, the calibration validity period can be longer or shorter depending on the intensity of use, environmental conditions and unit maintenance, as well as the specific requirements for your application. All of these elements must be taken into consideration when determining the appropriate calibration interval of this particular EXFO unit.

Under normal use, the recommended interval for your module is: 2 years.

For newly delivered units, EXFO has determined that the storage of this product for up to six months between calibration and shipment does not affect its performance (EXFO Policy PL-03).

Maintenance

Recycling and Disposal

To help you with calibration follow-up, EXFO provides a special calibration label that complies with the ISO/IEC 17025 standard and indicates the unit calibration date and provides space to indicate the due date. Unless you have already established a specific calibration interval based on your own empirical data and requirements, EXFO would recommend that the next calibration date be established according to the following equation:

Next calibration date = Date of first usage (if less than six months after the calibration date) + Recommended calibration period (2 years)

To ensure that your unit conforms to the published specifications, calibration may be carried out at an EXFO service center or, depending on the product, at one of EXFO's certified service centers. Calibrations at EXFO are performed using standards traceable to national metrology institutes.

Note: *You may have purchased a FlexCare plan that covers calibrations. See the Service and Repairs section of this user documentation for more information on how to contact the service centers and to see if your plan qualifies.*

Recycling and Disposal



This symbol on the product means that you should recycle or dispose of your product (including electric and electronic accessories) properly, in accordance with local regulations. Do not dispose of it in ordinary garbage receptacles.

For complete recycling/disposal information, visit the EXFO Web site at www.exfo.com/recycle.

14 Troubleshooting

Solving Common Problems

Before calling EXFO's technical support, please read the following common problems that can occur and their respective solution.

Problem	Possible Cause	Solution
Optical Laser LED is off and the connector is not generating the signal.	The Laser On option is disabled.	Ensure that the Laser button is enabled (On).
	There is a configuration mismatch between the inserted transceiver and the rate selected for the test case.	Ensure that the transceiver is supporting the rate used for the test case.
	The transceiver is not compatible with the module	Ensure to use a compatible transceiver. Refer to <i>Modify Structure Button</i> on page 108 and <i>Specifications</i> on page 675.
Unable to edit the Operator Name in Generate Report page	This is the expected behavior when the EXFO Connect Server check box is selected in EXFO Connect Client , since the Operator Name is selected from the EXFO Connect operator name list.	To edit the Operator Name : - Clear the EXFO Connect Server check box from EXFO Connect Client - Close and restart the module application.

Troubleshooting

Contacting the Technical Support Group

Contacting the Technical Support Group

To obtain after-sales service or technical support for this product, contact EXFO at one of the following numbers. The Technical Support Group is available to take your calls from Monday to Friday, 8:00 a.m. to 7:00 p.m. (Eastern Time in North America).

Technical Support Group

400 Godin Avenue
Quebec (Quebec) G1M 2K2
CANADA

1 866 683-0155 (USA and Canada)
Tel.: 1 418 683-5498
Fax: 1 418 683-9224
support@exfo.com

For detailed information about technical support, and for a list of other worldwide locations, visit the EXFO Web site at www.exfo.com.

If you have comments or suggestions about this user documentation, you can send them to customer.feedback.manual@exfo.com.

To accelerate the process, please have information such as the name and the serial number (see the product identification label), as well as a description of your problem, close at hand.

Transportation

Maintain a temperature range within specifications when transporting the unit. Transportation damage can occur from improper handling. The following steps are recommended to minimize the possibility of damage:

- Pack the unit in its original packing material when shipping.
- Avoid high humidity or large temperature fluctuations.
- Keep the unit out of direct sunlight.
- Avoid unnecessary shocks and vibrations.

15 Warranty

General Information

EXFO Inc. (EXFO) warrants this equipment against defects in material and workmanship for a period of one year from the date of original shipment. EXFO also warrants that this equipment will meet applicable specifications under normal use.

During the warranty period, EXFO will, at its discretion, repair, replace, or issue credit for any defective product, as well as verify and adjust the product free of charge should the equipment need to be repaired or if the original calibration is erroneous. If the equipment is sent back for verification of calibration during the warranty period and found to meet all published specifications, EXFO will charge standard calibration fees.



IMPORTANT

The warranty can become null and void if:

- unit has been tampered with, repaired, or worked upon by unauthorized individuals or non-EXFO personnel.
- warranty sticker has been removed.
- case screws, other than those specified in this guide, have been removed.
- case has been opened, other than as explained in this guide.
- unit serial number has been altered, erased, or removed.
- unit has been misused, neglected, or damaged by accident.

THIS WARRANTY IS IN LIEU OF ALL OTHER WARRANTIES EXPRESSED, IMPLIED, OR STATUTORY, INCLUDING, BUT NOT LIMITED TO, THE IMPLIED WARRANTIES OF MERCHANTABILITY AND FITNESS FOR A PARTICULAR PURPOSE. IN NO EVENT SHALL EXFO BE LIABLE FOR SPECIAL, INCIDENTAL, OR CONSEQUENTIAL DAMAGES.

Warranty

Liability

Liability

EXFO shall not be liable for damages resulting from the use of the product, nor shall be responsible for any failure in the performance of other items to which the product is connected or the operation of any system of which the product may be a part.

EXFO shall not be liable for damages resulting from improper usage or unauthorized modification of the product, its accompanying accessories and software.

Exclusions

EXFO reserves the right to make changes in the design or construction of any of its products at any time without incurring obligation to make any changes whatsoever on units purchased. Accessories, including but not limited to fuses, pilot lamps, batteries and universal interfaces (EUI) used with EXFO products are not covered by this warranty.

This warranty excludes failure resulting from: improper use or installation, normal wear and tear, accident, abuse, neglect, fire, water, lightning or other acts of nature, causes external to the product or other factors beyond the control of EXFO.



IMPORTANT

In the case of products equipped with optical connectors, EXFO will charge a fee for replacing connectors that were damaged due to misuse or bad cleaning.

Certification

EXFO certifies that this equipment met its published specifications at the time of shipment from the factory.

Service and Repairs

EXFO commits to providing product service and repair for five years following the date of purchase.

To send any equipment for service or repair:

1. Call one of EXFO's authorized service centers (see *EXFO Service Centers Worldwide* on page 673). Support personnel will determine if the equipment requires service, repair, or calibration.
2. If equipment must be returned to EXFO or an authorized service center, support personnel will issue a Return Merchandise Authorization (RMA) number and provide an address for return.
3. If possible, back up your data before sending the unit for repair.
4. Pack the equipment in its original shipping material. Be sure to include a statement or report fully detailing the defect and the conditions under which it was observed.
5. Return the equipment, prepaid, to the address given to you by support personnel. Be sure to write the RMA number on the shipping slip. *EXFO will refuse and return any package that does not bear an RMA number.*

Note: *A test setup fee will apply to any returned unit that, after test, is found to meet the applicable specifications.*

After repair, the equipment will be returned with a repair report. If the equipment is not under warranty, you will be invoiced for the cost appearing on this report. EXFO will pay return-to-customer shipping costs for equipment under warranty. Shipping insurance is at your expense.

Routine recalibration is not included in any of the warranty plans. Since calibrations/verifications are not covered by the basic or extended warranties, you may elect to purchase FlexCare Calibration/Verification Packages for a definite period of time. Contact an authorized service center (see *EXFO Service Centers Worldwide* on page 673).

EXFO Service Centers Worldwide

If your product requires servicing, contact your nearest authorized service center.

EXFO Headquarters Service Center

400 Godin Avenue
Quebec (Quebec) G1M 2K2
CANADA

1 866 683-0155 (USA and Canada)
Tel.: 1 418 683-5498
Fax: 1 418 683-9224
support@exfo.com

EXFO Europe Service Center

Winchester House, School Lane
Chandlers Ford, Hampshire S053 4DG
ENGLAND

Tel.: +44 2380 246800
Fax: +44 2380 246801
support.europe@exfo.com

EXFO Telecom Equipment (Shenzhen) Ltd.

3rd Floor, Building C,
FuNing Hi-Tech Industrial Park, No. 71-3,
Xintian Avenue,
Fuyong, Bao'An District,
Shenzhen, China, 518103

Tel: +86 (755) 2955 3100
Fax: +86 (755) 2955 3101
support.asia@exfo.com

To view EXFO's network of partner-operated Certified Service Centers nearest you, please consult EXFO's corporate website for the complete list of service partners:

<http://www.exfo.com/support/services/instrument-services/exfo-service-centers>.

A Specifications



IMPORTANT

The following general specifications can change without notice. The information presented in this section is provided as a reference only. To obtain this product's most recent technical specifications, visit the EXFO Web site at www.exfo.com.



CAUTION

The operation and storage temperatures, as well as the altitude, humidity and IP rating of some modules may differ from those specified for your platform. In this case, always ensure that you comply with the most restrictive conditions (either module or platform).

Specifications

General Specifications

Specification	8870/8880/ 88200NGE	88260	88400NGE
Size (H x W x D)	118 x 25 x 160 mm (4 5/8 x 1 x 6 3/8 in)	118 x 25 x 159 mm (4 5/8 x 1 x 6 3/8 in)	118 x 100 x 160 mm (4 5/8 x 4 x 6 3/8 in)
Weight (without transceiver)	8870: 0.35 kg (0.75 lb) 8880: 0.41 kg (0.9 lb) 88200NGE: 0.5 kg (1.1 lb)	0.9 kg (1.9 lb) (without transceiver adaptors)	1.7 kg (3.75 lb)
Temperature	Operating: 0 °C to 40 °C (32 °F to 104 °F) Storing: -40 °C to 70 °C (-40 °F to 158 °F)		
Relative humidity	0 % to 95 %, non-condensing		
Maximum operation altitude	5000 m (16000 ft)		
Pollution degree	3		
Measurement category	Not rated for measurement categories II, III, or IV		

Transceiver Adaptor (TA) for FTBx-88260

Specification	TA-QSFP28
Size (H x W x D)	99 x 25 x 56 mm (4 x 1 x 2 1/4 in)
Weight (without transceiver)	0.15 kg (0.33 lb)
Temperature	Operating: 0 °C to 40 °C (32 °F to 104 °F) Storing: -40 °C to 70 °C (-40 °F to 158 °F)
Relative humidity	0 % to 95 %, non-condensing
Maximum operation altitude	5000 m (16000 ft)
Pollution degree	3
Measurement category	Not rated for measurement categories II, III, or IV

B Glossary

Acronym List

10B_ERR	10B_Error
400GAUI-16	400 Gbit/s Attachment Unit Interface - 16 physical lanes
?	Help

A

AC	Alternating Current
ACH	Associated Channel Header
ACT	Activity
AIS	Alarm Indication Signal
AMI	Alternate Mark Inversion
APS	Automatic Protection Switching
ATM	Asynchronous Transfer Mode
AU-n	Administrative Unit-n
AUI	Attachment Unit Interface

B

B-VLAN	Backbone Virtual Local Area Network
B8ZS	Bipolar with 8 zero substitution
BB	Buffer to Buffer
BBE	Background Block Error
BBER	Background Block Error Ratio
BDI	Backward Defect Indication
BDP	Bandwidth Delay Product
BEI	Backward Error Indication
BER	Bit Error Rate

Glossary

Acronym List

BERT	Bit Error Rate Test
BIAE	Backward Incoming Alignment Error
BIP	Bit-Interleaved Parity
bit/s	Bit per second
BSD	Backward Signal Degrade
BSF	Backward Signal Fail

C

C	Current
C-DCI	Client - Defect Clear Indication
C-FDI	Client - Forward Defect Indication
C-LOS	Client - Loss Of Signal
C-RDI	Client - Remote Defect Indication
C-VLAN	Client/Customer Virtual Local Area Network
CAUI	100 Gbit/s Attachment Unit Interface
CAGE	Commerce And Government Entities
CBR	Constant Bit Rate
CBS	Committed Burst Size
CC	Continuity Check
CCM	Continuity Check Message
CE	Congestion Encountered
CD	Connectivity Defect
CDF	Client Data Frames
CE	European Conformity
cHEC	core Header Error Check
CID	Channel Identifier
CIR	Committed Information Rate
CLK	Clock

CMF	Client Management Frames
CORR	Correctable
COS	Class Of Service
CPRI	Common Public Radio Interface
CRC	Cyclic Redundancy Check
CRC-4	Cyclic Redundancy Check on 4 bits
CRITIC	Critical
CSF	Client Signal Fail
CSV	Comma Separated Value
cTE	constant Time Error
CV	Code Violation
CW	Code Word

D

DA	Destination MAC Address
DAPI	Destination Access Point Identifier
dBm	Decibel - milliwatts
DCC	Data Communications Channel
DCI	Defect Clear Indication
DM	Degraded Minutes
DMM	Delay Measurement Message
DMR	Delay Measurement Reply
DS0	Digital Signal-level 0 (64 Kbit/s)
DS1	Digital Signal-level 1 (1.544 Mbit/s)
DS3	Digital Signal-level 3 (44.736 Mbit/s)
DSn	Digital Signal-level n
DST	Destination
DTE	Data Terminal Equipment

Glossary

Acronym List

dTE _H	dynamic Time Error High
DUS	Don't Use for Synchronization
DUT	Device Under Test

E

E-VLAN	Extended Virtual Local Area Network
E0	European standard for digital transmission-level 0 (64 Kbit/s).
E1	European standard for digital transmission-level 1 (2.048 Mbit/s).
E2	European standard for digital transmission-level 2 (8.448 Mbit/s).
E3	European standard for digital transmission-level 3 (34.368 Mbit/s).
E4	European standard for digital transmission-level 4 (139.264 Mbit/s).
EB	Errored Block
EBS	Excess Burst Size
EC	Error Count
ECN	Explicit Congestion Notification
ECT	ECN Capable Transport
EEC	Ethernet Equipment Clock
EFS	Error Free Second
eHEC	extension Header Error Check
EIR	Excess Information Rate
EoE	Ethernet over Ethernet
EoOTN	Ethernet over OTN
ERDI	Enhanced RDI
ES	Errored Second
ESMC	Ethernet Synchronization Message Channel
ESF	Extended Superframe
ESR	Errored Second Ratio
ETag	Extended Tag

EUI	EXFO Universal Interfaces
EXI	Extension Header Identifier
EXM	Extension Header Mismatch
EXT CLK	External Clock

F

FAS	Frame Alignment Signal
FC	Fibre Channel
FCC	Federal Communications Commission
FCB	Frame Clock Burst
FCS	Frame Check Sequence
FD	Frame Delay
FDI	Forward Defect Indication
FEC	Forward Error Correction
FEC-UNCOR-CW	FEC Uncorrectable Codeword
FEC-COR-CW	FEC Correctable Codeword
FEC-SYMB	FEC Symbol
FlexE	Flex Ethernet
FLOGI	Fabric Login
FLR	Frame Loss Ratio
fps	Frame Per Second
FSD	Forward Signal Degrade
FSF	Forward Signal Fail

Glossary

Acronym List

G

GAL	Generic Associated Channel Label
GE	Gigabit Ethernet
Gbit/s	Gigabit per second
GCC	General Communication Channel
GFP	Generic Framing Procedure
GFP-F	GFP - Framed
GFP-T	GFP - Transparent
GHz	Giga Hertz
GM	Grand Master
GMP	Generic Mapping Procedure
GMP OOS	GMP Out of Synchronization
GUA	Global IPv6 Address
GUI	Graphical User Interface

H

H	History
HDB3	High Density Bipolar 3 Code
HDMI	High Definition Multimedia Interface
HDTV	High Definition Television
Hi-BER	High-Bit Error Ratio
Hi-BER1027B	High-Bit Error Ratio 1027 Blocks
HP-	High Order Path -
Hz	Hertz

I

IAE	Incoming Alignment Error
IAIS	Incoming Alarm Indication Signal
ID	Identification
IEC	International Electrotechnical Commission
IEC	Incoming Error Count
IEEE	Institute of Electrical & Electronics Engineers
IFDV	Inter-Frame Delay Variation
IN	Input
IP	Internet Protocol
IPDV	Inter Packet Delay Variation
IPTV	Internet Protocol Television
IPG	Interframe Gap
IPv4	Internet Protocol version 4
IPv6	Internet Protocol version 6
ISM	In-Service Monitoring

J

JC	Justification Control
----	-----------------------

L

-L	Line
L Deg SER Det	Local Degraded SER Detected
L Deg SER Rcd	Local Degraded SER Received
LAN	Local Area Network
LBM	Loopback Message
LBR	Loopback Reply

Glossary

Acronym List

LCD	Loss of Code-Group Delineation
LCK	Locked
LED	Light-Emitting Diode
LER	Label Edge Router
lb	Pound
LBO	Line Build Out
LFD	Loss of Frame Delineation
LLA	Link-Local IPv6 Address
LLC	Logical Link Control
LLM	Logical Lane Marker
LMM	Loss Measurement Message
LMR	Loss Measurement Reply
LOA	Loss Of Alignment
LOAML	Loss of Alignment Marker Lock
LOAML1027B	Loss of Alignment Marker Lock 1027 Blocks
LOBL	Loss of Block Lock
LOBL1027B	Loss of Block Lock 1027 Blocks
LOC	Loss Of Clock
LOC Lane	Loss Of Clock Lane
LOCS CSF	Loss of Client Signal - Client Signal Fail
LOCCS CSF	Loss of Client Character Synchronization - Client Signal Fail
LOF	Loss Of Frame
LOFLOM	Loss of Frame Loss Of Multiframe
LOL	Loss of Lane Alignment
LOM	Loss Of Multiframe
LOOMFI	Loss of OPU Multi-Frame Identifier
LOPPS-L	Loss Of Pulse Per Second - Local
LOPPS-R	Loss Of Pulse Per Second - Remote

LOP	Loss Of Pointer
LOR	Loss Of Recovery
LOS	Loss Of Signal
LSB	Least-Significant Bit
LSP	Label Switch Path
LSR	Label Switching Router
LSS	Loss of Sequence Synchronization
LTC	Loss of Tandem Connection
LTM	Link Trace Message
LTR	Link Trace Reply

M

m	Minute
m	Meter
MA	Maintenance Association
MAC	Media Access Control
MAID	Maintenance Association Identification
Mbit/s	Megabit per second
MD	Maintenance Domain
MDI	Media Dependant Interface (straight through Ethernet cable)
MDIO	Management Data Input/Output
MDIX	Media Dependant Interface Crossover (crossover Ethernet cable)
ME	Maintenance Entity
MEG	ME Group
MEG ID	MEG Identification
MEP	MEG End Point
MFAS	Multiframe Alignment Signal
MHz	Megahertz

Glossary

Acronym List

MIP	MEG Intermediate Point
MPD	Mean Path Delay
MPLS	Multiprotocol Label Switching
MS	Multiplex Section
MSA	Multisource Agreement
MSB	Most-Significant Bit
MSEQV	Marker Sequence Violation
msg/s	Message per second
MSIM	Multiplex Structure Identifier Mismatch
MTIE	Maximum Time Interval Error
MTU	Maximum Transfer Unit

N

NAT	Network Address Translation
NATO	North Atlantic Treaty Organization
nAUI	400GAUI-16, CAUI, or XLAUI
NDF	New Data Flag
NE	Network Element
NID	Network Interface Device
NJO	Negative Justification Opportunity
nm	Nanometer

O

OAM	Operation, Administration, and Maintenance
OBSAI	Open Base Station Architecture Initiative
OC-	Optical Carrier-
OCI	Open Connection Indication

ODI	Outgoing Defect Indication
ODU	Optical Data Unit
OEI	Outgoing Error Indication
OH	Overhead
OLA	Out-of-Lane-Alignment
OMFI	OPU Multi-Frame Identifier
OOMFI	Out of OPU Multi-Frame Identifier
OOF	Out-Of-Frame
OOM	Out-Of-Multiframe
OOR	Out-Of-Recovery
OOS	Generic Mapping Procedure Out Of Synchronization
OOS	Out-Of-Sequence
OOSM	Out-Of-Service Monitoring
OPU	Optical Payload Unit
OTL	Optical channel Transport Lane
OTN	Optical Transport Network
OTU	Optical Transport Unit
OUI	Organizationally Unique Identifier
OUT	OUTput

P

-P	Path
PBB-TE	Provider Backbone Bridges with Traffic Engineering
PC	Personal Computer
PCD	Path Connectivity Defect
PCP	Priority Code Point
PCS	Physical Coding Sublayer
PD	Payload Defect

Glossary

Acronym List

PDI	Payload Defect Indication
PDU	Protocol Data Unit
PE	Provider Edge
pFCS	payload Frame Check Sequence
PFI	Payload Frame Check Sequence Identifier
PHY	Physical Layer Device
PLI	Payload Length Indicator
PLM	Payload Label Mismatch
PLOGI	Port Login
PM	Performance Monitoring
PNO	Provisionable by the Network Operator
POS	Position Field
POSV	Position Field Violation
PPD	Path Payload Defect
ppm or PPM	parts per million
PRBS	Pseudo Random Bit Sequence
PRS	Primary Reference Source/Clock
PRC	Primary Reference Source/Clock
PSD	Path Server Defect
PSI	Payload Structure Identifier
PTI	Payload Type Identifier
PTP	Precision Time Protocol
Ptr. Incr.	Pointer Increment
Ptr. Decr.	Pointer Decrement
PTSF	Packet Timing Signal Fail
PW	Pseudo-Wire

Q

QL	Quality Level
QoS	Quality of Service
QSFP	Quad Small Form Factor Pluggable

R

R Deg SER	Remote Degraded SER
RDI	Reverse Defect Indication
RDI	Remote Defect Indication
REI	Remote Error Indicator
RES	Reserved
RFI	Remote Failure Indication
RMA	Return Merchandise Authorization
RPn	Reference Point n
RS-	Regenerator Section
RTD	Round Trip Delay
RTT	Round Trip Time
RX	Receive

S

s	second
-S	Section
S-OAM	Service - OAM
S-VLAN	Service Virtual Local Area Network
SA	Source MAC Address
SAPI	Source Access Point Identifier
SB	Superblock

Glossary

Acronym List

SD	Server Defect
SDH	Synchronous Digital Hierarchy
SDT	Service Disruption Time
SDTV	Standard Digital Television
SEF	Severely Errored Framing
SEP	Severely Errored Period
SEQV	Sequence Violation
SES	Severely Errored Second
SESR	Severely Errored Second Ratio
SF	Superframe
SFN	System Frame Number
SFP	Small Form Factor Pluggable
SI	International System
SID	Service Instance Identifier
SLA	Service-Level Agreement
SLM	Synthetic Loss Message
SLR	Synthetic Loss Reply
SM	Section Monitoring
SMA	Sub-Miniature A Connector
SMC	SONET Minimum Clock Traceable
SNAP	Sub Network Access Point
SOF	Start Of Frame
SONET	Synchronous Transport Signal
SP	Service Provider
SPE	Synchronous Payload Envelope
SR4	Short Reach (4 Lanes)
SRC	Source
SSM	Synchronization Status Messaging

ST1	Stratum 1 Traceable
ST2	Stratum 2 Traceable
ST3	Stratum 3 Traceable
ST3E	Stratum 3E Traceable
STM	Synchronous Transport Module
STS	Synchronous Transport Signal
STU	Synchronized - Traceability Unknown
SYMB	Symbol
SW	Software

T

TA	Transceiver Adaptor
TC	Traffic Class
TCM	Tandem Connection Monitoring
TCP	Transport Control Protocol
TDEV	Time Deviation
TE	Time Error
tHEC	type Header Error Check
TIE	Time Interval Error
TIM	Trace Identifier Mismatch
TLV	Type, Length, and Value
TNC	Transit Node Clock Traceable
TOS	Type Of Service
TST	Test PDU
TTI	Trail Trace Identifier
TTL	Time To Live
TU	Tributary Unit

Glossary

Acronym List

TUG	Tributary Unit Group
TX	Transmit

U

UAS	Unavailable Second
UDP	User Data Protocol
UNCORR	Uncorrectable
UNEQ	Unequipped
UPI	User Payload Identifier
UPM	User Payload Mismatch
μs	microsecond
USA	United States of America
UTP	Unshielded Twisted Pairs

V

V	VT
VC	Virtual Container
VIOL	Violation
VLAN	Virtual Local Area Network
VoIP	Voice over Internet Protocol
VT	Virtual Tributary
VTG	VT Group

W

WAN	Wide Area Network
WIS	WAN Interface Sublayer
WWN	World Wide Name

X

XLAUI	40 Gbit/s Attachment Unit Interface
-------	-------------------------------------

10G Ethernet Client

The OTN Overclocked technology provides the capability to transparently transport 10G base-R Ethernet signals into OPU2 as specified in ITU-T. Two optical rates are provided:

- 11.0957 Gbits/s, +/- 100 ppm, designated OTU2e
- 11.0491 Gbits/s, +/- 100 ppm, designated OTU1e

The OTU2e uses the mapping scheme of CBR10G into OPU2 as defined in G.709. The client signal, 10GE LAN and the OPU fixed stuff bytes are accommodated into an OPU-like signal designated OPU2e. This signal is then wrapped in an ODU2e and then in an OTU2e signal.

The OTU1e uses the mapping scheme of CBR2G5 into OPU1 as defined in G.709. The client signal, 10GE LAN is accommodated into an OPU-like signal designated OPU1e (note that the fixed stuff bytes are not left free) this is why the 10GE signal can be transported at a lower rate than OTU2e. This signal is then wrapped in an ODU1e and then in an OTU1e signal.

The transparent transport of the 10G base-R means that the full 10G Ethernet data rate i.e. 10.3125 Gbit/s is transported over OTN. This means that the following information is transported:

- PCS 64B/66B coded information
- IPG (inter-frame filler), MAC FCS, Preamble and SFD (start of frame delimiter) and Ordered Sets (Remote Fault indication)

The OTN clocking is derived from the Ethernet client signal which is +/- 100 ppm, this is outside the clock tolerance allocated by the G.709 standard which translates in unspecified jitter performance thus limiting the application to Point to Point data path.

The following figure presents a typical network application.

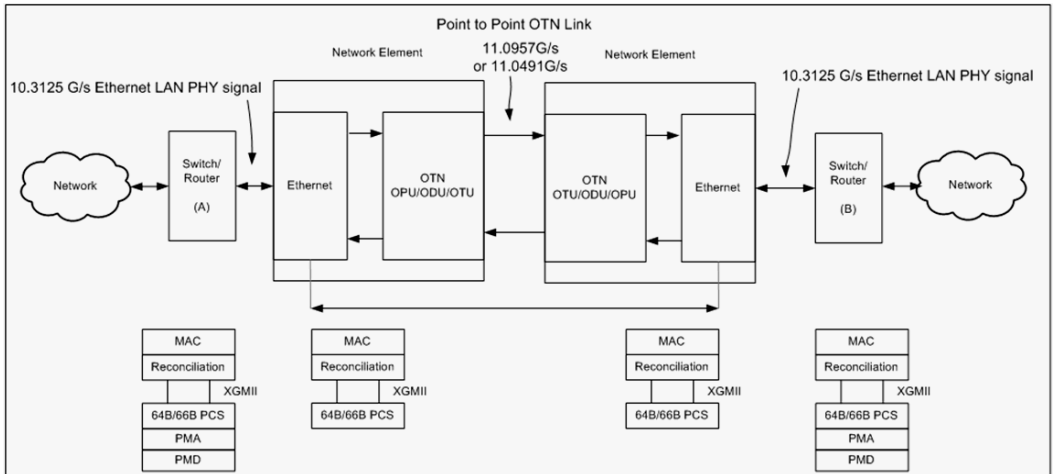

Glossary

10G Ethernet Client

The following figure presents a typical test application.

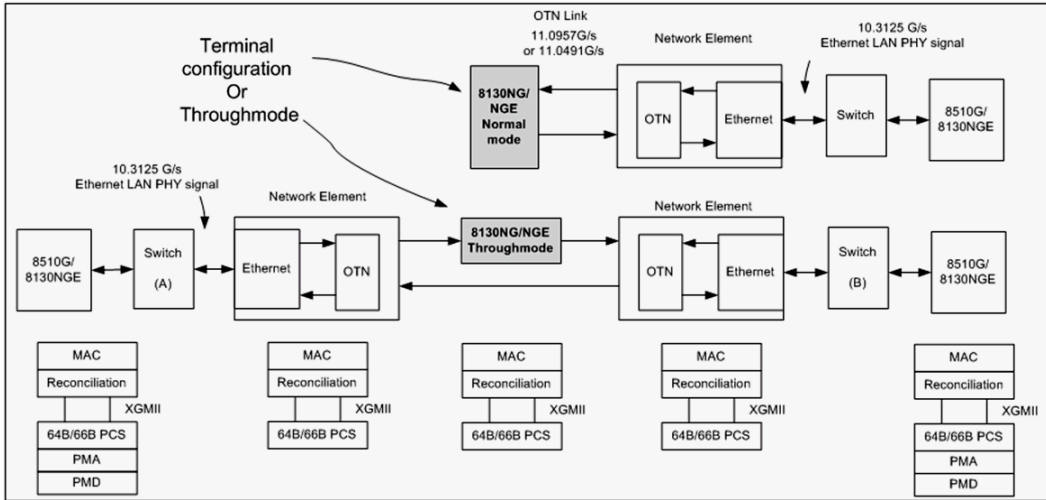

The Ethernet layer provides the equivalent functionality of the BERT Framed Layer 2 Test application supported on EXFO's Datacom product family with the particularity that there is no Ethernet Physical port as such. The Ethernet frame has its Ethertype field set to 0x88B7.

1588 PTP

The goal of the IEEE 1588 Precision Time Protocol (PTP) is to provide Network Synchronization using a packet based distribution mechanism.

Depending on the system application the Network Synchronization may require phase and frequency synchronization. 1588 PTP has the capability to deliver both by allowing a Client clock to track a Master clock in phase (time of day) and in frequency.

The protocol is based on exchange of time stamps between the Master clock and the Client clock. Two methods have been defined in the 1588 PTP standard:

- **Delay Request-Response** mechanism uses message Sync, Delay Request, Delay Response, and Follow Up (if required).

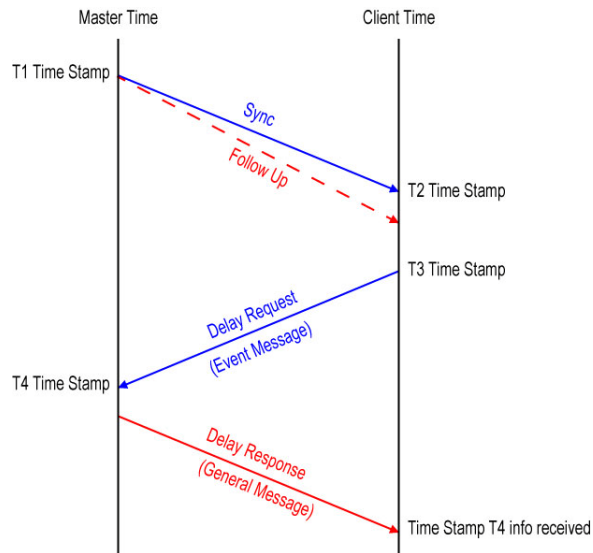

- **Peer Delay** mechanism uses message Pdelay Request, Pdelay Response, and if required Pdelay Response Follow Up. This mechanism is restricted to topologies where each peer-to-peer port communicates PTP messages with, at most, one other such port. Peer Delay is not supported by the Telecom Profile.

In order to minimize traffic on the network, PTP can operate in different modes:

- **Two-way** operation uses Sync/Follow Up, Delay Request, and Delay Response messages.
- **One-way** operation uses only the Sync/Follow Up messages. This mode of operation is used to synchronize a Client clock in frequency only. The Master clock and Client clock phases are not aligned.
- **Two-step** clock mode uses the optional Follow Up message to carry the T1 time stamp.
- **One-step** clock mode uses the Sync message to carry the T1 time stamp; no Follow Up message is transmitted by the Master clock, therefore less traffic on the network.

Client clock synchronization is achieved with a 2-part process:

- Part 1: Path delay measurement using bidirectional messages
Mean path delay measurement (MPD) = $((T2-T1) + (T4-T3)) / 2$
- Part 2: Clock phase offset correction
Offset = $(T2-T1) - MPD$

The offset information is used by the Client clock to adjust the frequency of its oscillator in order to keep the phase offset close to zero.

The 1588 PTP supports the following Master/Client communication; however **Unicast** is used for the Telecom Profile.

- **Multicast:** A Master clock sends its Sync/Follow Up and Delay Response in a multicast mode. A Client can collect information from many Master clocks and select the Master clock that is best suited for its application.
- **Unicast:** A dedicated communication link is established between the Master and the Client clock. This mode of operation requires a negotiation which is initiated by the Client clock.

The 1588 PTP messages can be mapped on the following protocols; however UDP IPv4 is used for the Telecom Profile.

- UDP/IPv4
- UDP/IPv6
- Ethernet

1588 PTP Profiles

The purpose of a PTP profile is to allow organizations to specify particular selections of attribute values and optional features of PTP that, when using the same transport protocol, inter-work and achieve a performance that meets the requirements of a given application.

Telecom Profile G.8265.1

The Telecom Profile G.8265.1 is designed for frequency synchronization in Telecom network applications. The main attributes of this profile are:

- Unicast communication with the Grand Master
- UDP/IPv4 network layer

With the Telecom Profile, the Client Clock initiates the communication to the Master Clock by making a request for service that consists of sending Signaling messages containing a REQUEST UNICAST TRANSMISSION TLV to the IP address of the Master Clock.

If the Master Clock has sufficient capacity to handle the Client Clock request, it responds with a signaling message containing a GRANT UNICAST TRANSMISSION TLV.

The REQUEST UNICAST TRANSMISSION TLV contains several parameters:

- **messageType** is the type of service being requested: Announce, Sync, or Delay Response.
- **durationField** is the duration of the requested service: 300 seconds by default and configurable from 60 to 1000 seconds.
- **logInterMessagePeriod**: transmission rate of the requested messages.

If the Master Clock denies the request, e.g. because it has no remaining capacity, it will send back a GRANT UNICAST TRANSMISSION TLV with the durationField set to zero.

In the event of being denied service by a Master Clock, or receiving no response to the service request, a Client Clock should wait a minimum of one second before issuing a new Unicast request to that Master Clock.

As Unicast service is only granted for a limited time, the Client Clock must re-request service periodically, before the expiration of the current grant. The Client Clock should reissue the request sufficiently far in advance of the expiration to allow the request to be repeated at least twice if no grant is received. This parameter is called Unicast renewal interval.

The following diagram shows the sequence of message exchange between a Client Clock and a Master Clock. First, the Client request Unicast Announce message service. When this is granted and the first Announce message is received, the Client can check the QL value conveyed in the clockClass field of the message. From there the Client Clock can request service for Sync and Delay Request messages. Service requests are reissued at the end of the Announce duration interval to ensure continuity of service.

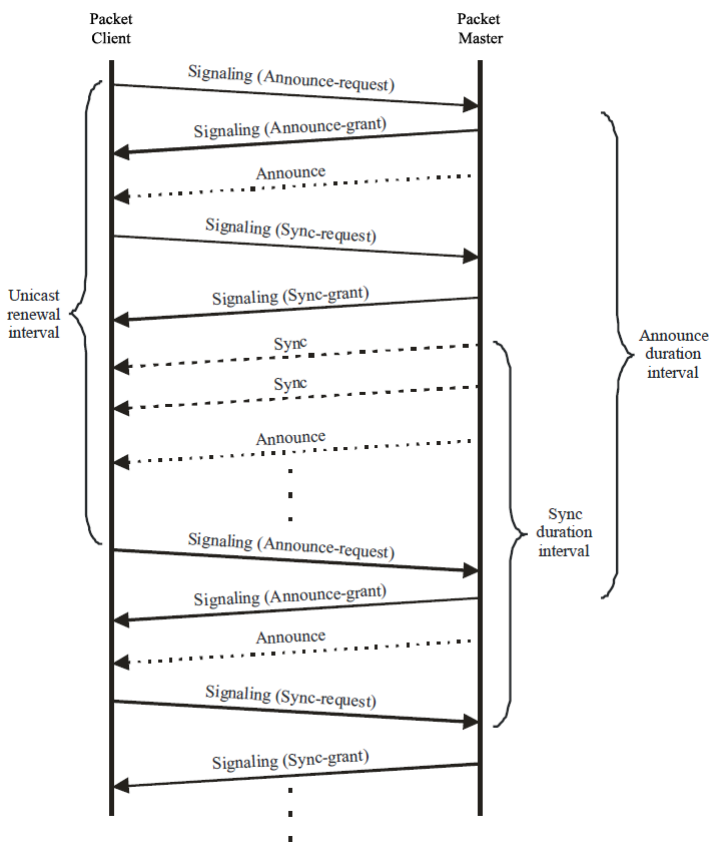

Telecom Profile G.8275.1

The Telecom Profile G.8275.1 is designed for time/phase synchronization in telecom network applications. The main attribute of this profile are:

- Full timing support from the network, i.e. all network nodes are boundary clocks
- Slave clocks synchronize with its respective upstream Boundary Clock
- 1588 messages are mapped on Ethernet Multicast

A very important distinction that has to be made compared with G.8265.1 is the mandatory use of Boundary Clocks with G.8275.1. With G.8265.1, network nodes such as Ethernet Switches or Routers were not required to be PTP aware. With G.8275.1, all network nodes needs to be PTP aware. This means that regular Ethernet Switches or Routers cannot be used. Switches/Routers are required to include the Boundary Clock functionality.

CPRI

Overview

Traditional mobile installations are bulky (use thick coaxial cables) and require a lot of power to operate (there is a huge power loss in the coaxial cabling which often requires the use of Tower Mounted Amplifiers) as outlined in the following figure.

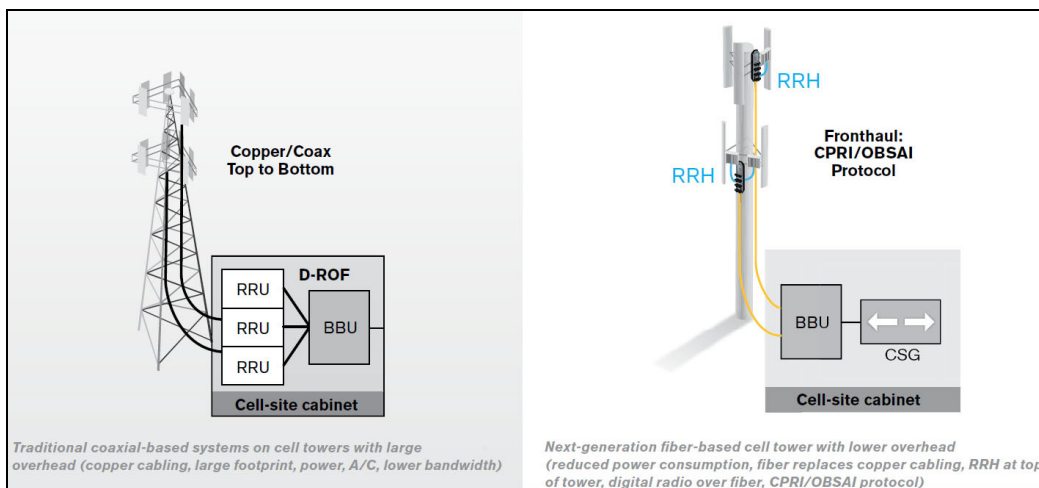

Pressures on the Mobile Network Operators (MNO) to reduce their capital, operational cost, and increase coverage are at the heart of a revolution in the mobile network. To address the situation, a concept of decomposition of the radio base station has been developed where the radio basic functions and its ability to transmit and receive radio modulated signals are separated. In such a distributed environment a protocol is required to maintain synchronization and management capabilities as well as transporting the user traffic between the simplified Base Transceiver Station (BTS) and its Remote Radio Head (RRH).

Glossary

CPRI

This protocol called Common Public Radio Interface (CPRI) separates a traditional radio base station configuration into two separate elements: Radio Equipment Control (REC) and the Radio Equipment (RE). The REC processes the baseband radio digital information and performs the control of the Radio Equipment. The RE converts the digital radio information into radio frequency signals transported over the air interface (antenna). The REC and RE are interconnected by a point-to-point link. This link carries the CPRI protocol and is known in the industry as the fronthaul as opposed to the backhaul that is the WAN bringing the network traffic to the base station.

The CPRI link can be extended over several kilometers as it uses fiber optics, in fact it can be deployed up to 40 km although most field installations at the moment of this writing are below 10 km.

The CPRI standard covers the physical and data link layers only. This specific focus provides additional development freedom to the various vendors to implement proprietary functions at upper layers.

Functional Description

As mentioned earlier, CPRI remotely locates the RE from the REC. This means that the RE must be controlled, managed and synchronized from the REC in addition to transporting the User information (Voice and user application data) and all that on the same digital link. As such, CPRI is composed of 3 communication flows multiplexed into a single serial signal transmitted in the same optical fiber as illustrated in the following figure.

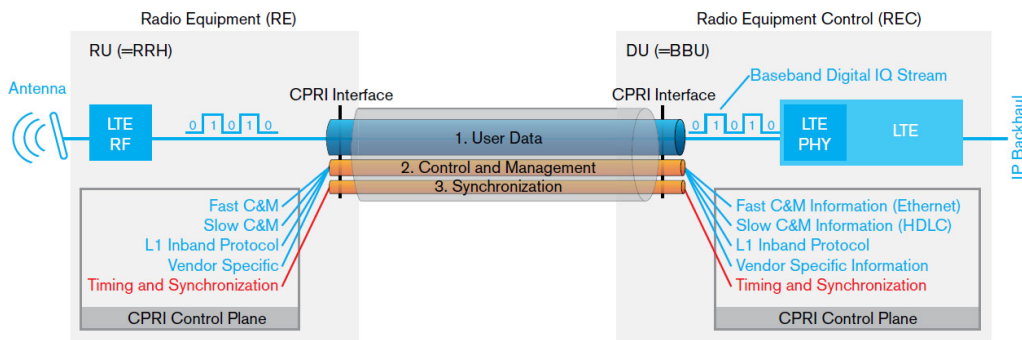

An electrical link is also available from CPRI but it is typically used for base station shelf interconnection. Since a state machine drives the link parameters (rates, protocol, and C&M channel) alignment, a BTS (defined as Master in the standard) and RRH (defined as Slave in the standard) interfaces are defined where the Master initiates the negotiation procedure necessary to achieve this alignment.

- **Synchronization:** Provides precise frequency and frame timing alignment from BTS to RRH to ensure accurate frequency and timing of the RF signal transmission and reception on the Air Interface. In essence, it provides the reference frequency for the RE.
- **Control & Management (C&M):** Management of the link between the REC and RE as well as control over radio functions such as alarms and power.
- **User:** Also known as IQ Data, represents the voice and data information that is exchanged by end-User Equipment (UE)

CPRI Model

The CPRI Model revolves around the 3 communication flows described above. CPRI defines only the Layer 1 and Layer 2 associated to these communication flows as outlined in the following figure.

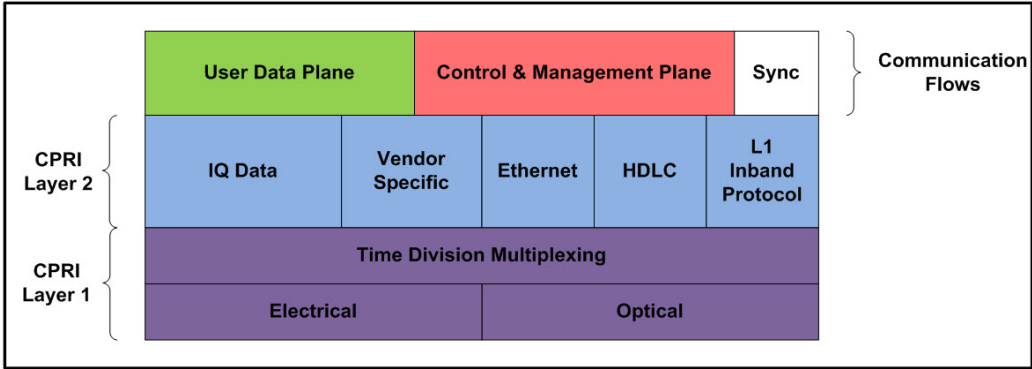

The User Data Plane contains mostly voice/data traffic in the form of IQ Data samples. IQ Data digitally encodes the change in amplitude/phase of a user device modulated signal sampled at the RE antenna.

The Control & Management Plane maintains the CPRI link itself and provides the facility to manage the operation of the RE radio functions. It is done through the L1 Inband Protocol which provides a bit oriented channel defined to support link specific alarms (R-LOS, R-LOF, ...). Also, the Ethernet/HDLC channel offer two OAM&P channel alternatives which are respectively high and low bandwidth with rates configurable based on the CPRI line interface rate. These carry proprietary information between the REC and RE. Some Vendor Specific overhead is also available.

Finally, the Synchronization flow ensures frequency stability and offers the overhead necessary for frame alignment between the REC and RE to ensure hitless channel or frequency hopping. All these flows are time division multiplexed onto one optical fiber for CPRI field deployments such as Distributed Antenna Systems (DAS).

Physical Interface

CPRI offers 8 options in terms of interface rates. Rates below 10G uses 8B/10B line coding as per CPRI V6.0 while rates above 10G use 64B/66B coding. Depending on the rates used, scrambling is optional. Depending on the CPRI signal structure (Framed or Unframed) the scrambling is either manually configured or negotiated.

Option	Rate	Line Coding	Protocol Version (Scrambling)
1	614.4 Mbit/s	8B/10B	Version 1: No scrambling
2	1.2288 Gbit/s		
3	2.4576 Gbit/s		
4	3.0720 Gbit/s		
5	4.9152 Gbit/s		Version 1: No scrambling Version 2: Scrambling (Scrambling is optional)
6	6.1444 Gbit/s		
7	9.8304 Gbit/s		
8	10.1376 Gbit/s	64B/66B	Version 2: Scrambling

Ethernet Cables

Minimum Category 3 cable is required for 10Base-T connection while Category 5 cable is required for 100Base-TX and 1000Base-T connections.

Maximum cable length (between two nodes) for 10Base-T, 100Base-TX, or 1000Base-T connection is 328 feet (100 meters).

➤ **Straight Through Cable (10/100 Mbit/s)**

An Unshielded Twisted Pair (UTP) straight through cable is required to connect a 10Base-T/100Base-TX module port to a layer 1 or 2 device (ex: HUB, switch).

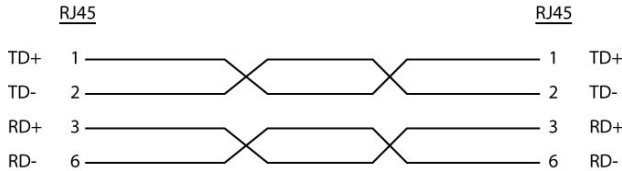

➤ **Crossover Cable (10/100 Mbit/s)**

An Unshielded Twisted Pair (UTP) crossover cable is required to connect the 10Base-T/100Base-TX module port to a layer 3 device (ex: router).

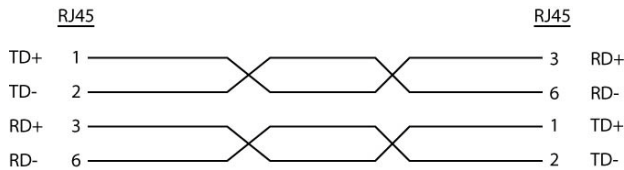

➤ **Straight Through Cable (1000 Mbit/s)**

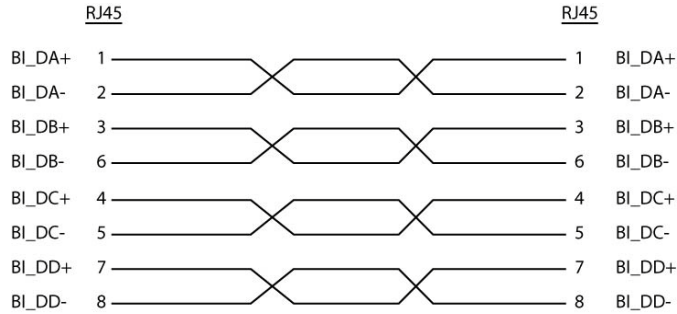

➤ **Crossover Cable (1000 Mbit/s)**

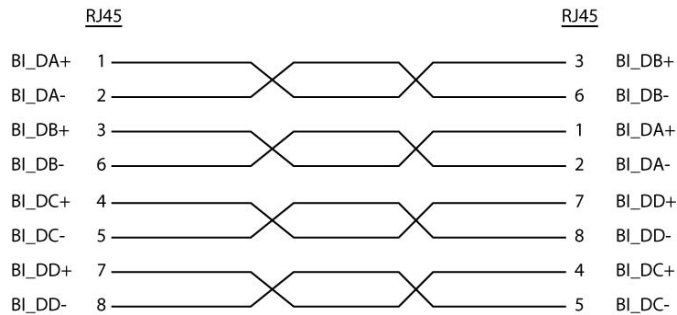

G.709 Optical Transport Network (OTN)

Overview

The optical transport network (OTN) combines the benefits of SONET/SDH technology with the bandwidth expansion capabilities offered by dense wavelength-division multiplexing (DWDM) technology.

The OTN consists of the following layers:

- Optical Transport Section (OTS)
- Optical Multiplex Section (OMS)
- Optical Channel (OCh)
- Optical channel Transport Lane (OTL)
- Optical Transport Unit (OTU)
- Optical Data Unit (ODU)
- Optical Channel Payload Unit (OPU)

Each of these layers and their functions are distributed along the network and activated when they reach their termination points, which are illustrated in the following figure.

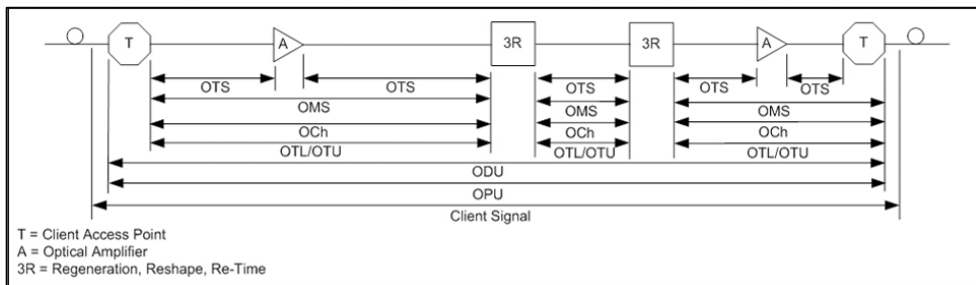

OTN Layer Termination Points

The termination of the OTS, OMS and OCh layers is performed at the optical level of the OTN. It is at the termination of the OTU layer that further functionality can be added. This layer is the digital layer—also known as the “digital wrapper”—and offers specific overhead to manage the OTN’s digital functions. The OTU also introduces a new dimension to optical networking by adding forward error correction (FEC) to the network elements, allowing operators to limit the number of required regenerators used in the network which, in turn, lowers its cost.

FEC allows an increase in the optical link budget by providing a new method to correct errors, thereby reducing the impact of network noise and other optical phenomena experienced by the client signal traveling through the network.

The OTU also encapsulates two additional layers—the ODU and the OPU—which provide access to the payload (SONET, SDH, etc.). These layers are normally terminated at the same location.

Glossary

G.709 Optical Transport Network (OTN)

The OTU, ODU (including the ODU tandem connection) and OPU layers can all be analyzed and monitored. As per ITU G.709, current test solutions offer these possibilities using the following line rates:

- OTU1 ($255/238 \times 2.488\,320$ Gbit/s ≈ 2.666057143 Gbit/s) also referred to as 2.7 Gbit/s
- OTU2 ($255/237 \times 9.953280$ Gbit/s ≈ 10.709225316 Gbit/s) also referred to as 10.7 Gbit/s
- OTU3 ($255/236 \times 39.813120$ Gbit/s ≈ 43.018413559 Gbit/s) also referred to as 43 Gbit/s
- OTU4 ($255/227 \times 99.532\,800$ Gbit/s ≈ 111.809973568 Gbit/s) also referred to as 112 Gbit/s.

The following non standard rates are also defined:

- OTU1e ($255/238 \times 10.3125$ Gbit/s ≈ 11.0491071429 Gbit/s)
- OTU2e ($255/237 \times 10.3125$ Gbit/s ≈ 11.0957278481 Gbit/s)
- OTU3e1 ($255/236 \times 4 \times 10.3125$ Gbit/s ≈ 44.570974576 Gbit/s)
- OTU3e2 ($243/217 \times 16 \times 2.488320$ Gbit/s ≈ 44.583355576 Gbit/s)

The following non standard rates are not covered by the ITU standard but they are the equivalent function associated to Fiber Channel rates:

- OTU1f ($255/238 \times 10.51875$ Gbit/s ≈ 11.2700892857143 Gbit/s)
- OTU2f ($255/237 \times 10.51875$ Gbit/s ≈ 11.3176424050633 Gbit/s)

Each line rate is adapted to service different client signals:

- OC-48/STM-16 is transported via OTU1
- OC-192/STM-64 is transported via OTU2
- OC-768/STM-256 is transported via OTU3
- Null Client (All 0s) is transported via OTU_k (k = 1, 2, 1e, 2e, 1f, 2f, 3, 3e1, 3e2, 4)
- PRBS31 is transported via OTU_k (k = 1, 2, 1e, 2e, 1f, 2f, 3, 3e1, 3e2, 4)

In order to map client signals via ITU G.709, they are encapsulated using the structure illustrated in the following figure.

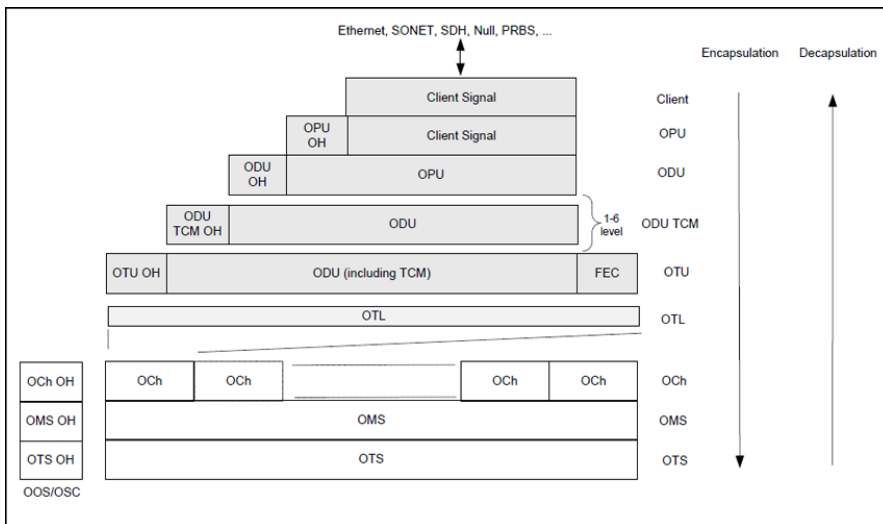

Basic OTN Transport Structure

Glossary

G.709 Optical Transport Network (OTN)

As depicted above, to create an OTU frame, a client signal rate is first adapted at the OPU layer. The adaptation consists of adjusting the client signal rate to the OPU rate. Its overhead contains information to support the adaptation of the client signal. Once adapted, the OPU is mapped into the ODU. The ODU maps the OPU and adds the overhead necessary to ensure end-to-end supervision and tandem connection monitoring (up to six levels). Finally, the ODU is mapped into an OTU, which provides framing as well as section monitoring and FEC.

Following the OTN structure presented in figure *Basic OTN Transport Structure* on page 713, OTUks ($k = 1, 2, 3$) are transported using the OCh; each unit is assigned a specific wavelength of the ITU grid. Several channels can be mapped into the OMS and then transported via the OTS layer. The OCh, OMS and OTS layers each have their own overhead for management purposes at the optical level. The overhead of these optical layers is transported outside of the ITU grid in an out-of-band channel called the optical supervisory channel (OSC).

When the OTU frame structure is complete (OPU, ODU and OTU), ITU G.709 provides OAM&P functions that are supported by the overhead.

OTU Frame Structure and Overhead

As shown in the figure below, the OTU frame is broken down into the following components:

- Framing
- OTL, OTU, ODU, OPU overhead
- OTU FEC

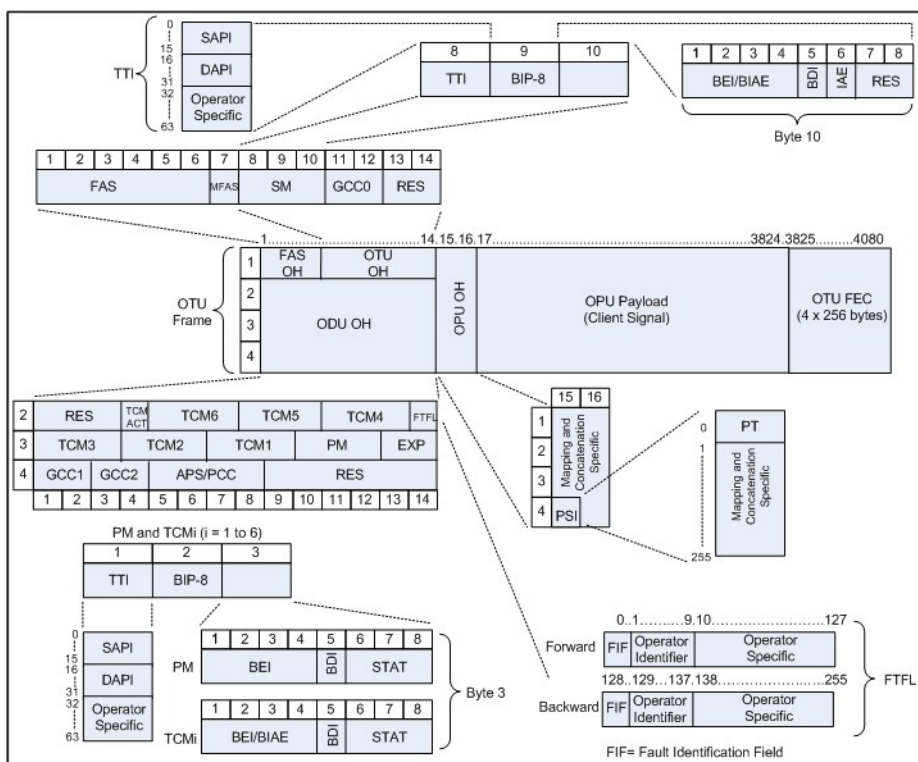

OTU Frame Description

Glossary

G.709 Optical Transport Network (OTN)

► Framing

The OTU framing is divided into two portions: FAS and MFAS.

The frame alignment signal (FAS) uses the first six bytes and, similarly to SONET/SDH, it is used to provide framing for the entire signal. In order to provide enough 1/0 transitions for synchronization, scrambling is used over the entire OTU frame, except for the FAS bytes.

The multiframe alignment signal (MFAS) byte is used to extend command and management functions over several frames. The MFAS counts from 0 to 255, providing a 256 multiframe structure.

► Overhead

Each portion of the OTU frame has its own specific overhead functions. They are displayed in figure *OTU Frame Description* on page 715, and are briefly described below. Further details can be found about these overhead fields in the ITU G.709 standard.

► Optical channel Transport Lane (OTL)

The Optical channel Transport Lane (OTL) is an adaptation layer whose purpose is to re-use the modules developed for Ethernet 40GBASE-R and 100GBASE-LR4. These modules have a four-lane WDM interface to and from a transmit/receive pair of G.652 optical fibers, and connect to the host board via a 4-lane (OTL3.4) or 10-lane (OTL4.10) electrical interface.

The OTL layer is responsible for mapping the serial OTU signal onto a parallel path designated lanes. In the case of OTU4 the signal is distributed over 20 logical lanes and for OTU3 the signal is distributed over 4 logical lanes.

➤ **Optical Transport Unit (OTU)**

The OTU overhead is comprised of the SM, GCC0 and RES bytes.

The section monitoring (SM) bytes are used for the trail trace identifier (TTI), parity (BIP-8) and the backward error indicator (BEI), or backward incoming alignment error (BIAE), backward defect indicator (BDI), and incoming alignment error (IAE). The TTI is distributed over the multiframe and is 64 bytes in length. It is repeated four times over the multiframe.

General communication channel 0 (GCC0) is a clear channel used for transmission of information between OTU termination points.

The reserved (RES) bytes are currently undefined in the standard.

Glossary

G.709 Optical Transport Network (OTN)

➤ **Optical Data Unit (ODU)**

The ODU overhead is broken into several fields: RES, PM, TCMi, TCM ACT, FTFL, EXP, GCC1/GCC2 and APS/PCC.

The reserved (RES) bytes are undefined and are set aside for future applications.

The path monitoring (PM) field is similar to the SM field described above. It contains the TTI, BIP-8, BEI, BDI and Status (STAT) field.

There are six tandem connection monitoring (TCMi) fields, which contain the BEI/BIAE, BDI and STAT fields. The STAT field is used in the PM and TCMi fields to provide an indication of the presence or absence of maintenance signals.

The tandem connection monitoring activation/deactivation (TCM ACT) field is currently undefined in the standards.

The fault type and fault location reporting communication channel (FTFL) is a message spread over a 256-byte multiframe that provides the ability to send forward and backward path-level fault indications.

The experimental (EXP) field is a field that is not subject to standards and is available for network operator applications.

General communication channels 1 and 2 (GCC1/GCC2) fields are very similar to the GCC0 field except that each channel is available in the ODU.

The automatic protection switching and protection communication channel (APS/PCC) supports up to eight levels of nested APS/PCC signals, which are associated to a dedicated-connection monitoring level depending on the value of the multiframe.

➤ **Optical Payload Unit (OPU)**

The primary overhead field associated to the OPU is the Payload Structure Identifier (PSI). This is a 256 bytes multi-frame where its first byte is defined as the Payload Type (PT). The remaining 255 bytes are currently reserved.

The other fields in the OPU overhead are dependent on the mapping and concatenation capabilities associated to the OPU. For an asynchronous mapping (the client signal and OPU clock are different) Justification Control (JC) bytes are available to compensate for clock rate differences, two methods are supported Asynchronous Mapping Procedure (AMP) and Generic Mapping Procedure (GMP). For a purely Bit-Synchronous Mapping Procedure (BMP) (client source and OPU clock are the same), the JC bytes become reserved (set to 0). Concatenation bytes are also available as described in ITU G.709.

Glossary

Tandem Connection Monitoring (TCM)

TCM enables the user and its signal carriers to monitor the quality of the traffic that is transported between segments or connections in the network. SONET/SDH allowed a single level of TCM to be configured, while ITU G.709 allows six levels of tandem connection monitoring to be configured. The assignment of monitored connections is currently a manual process that involves an understanding between the different parties. There are various types of monitored connection topologies: cascaded, nested and overlapping. Examples of these topologies are provided in the following figure.

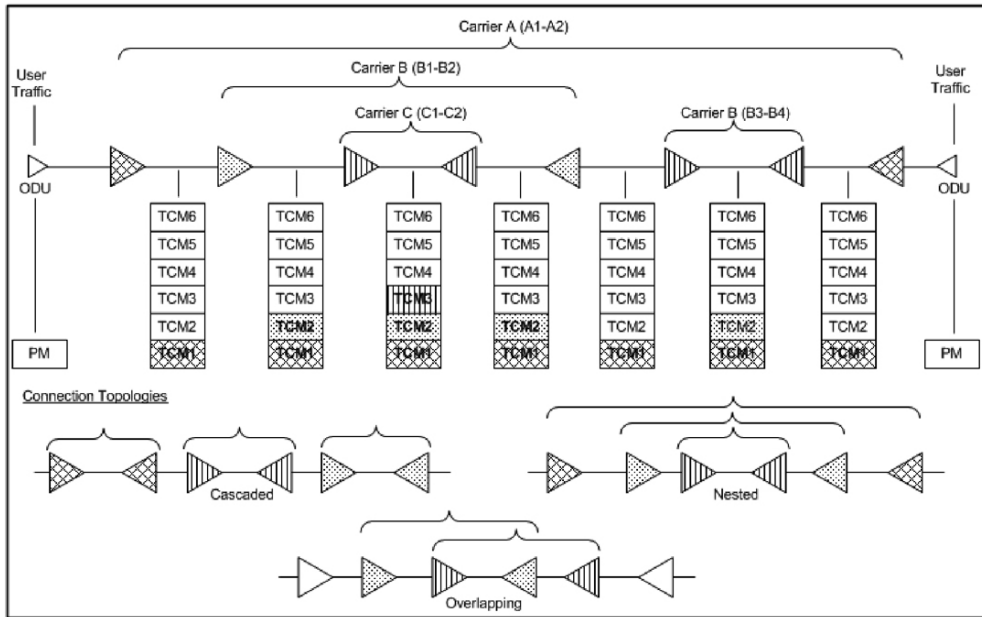

Tandem Connection Monitoring

Each of the six TCMi fields in the ODU overhead is assigned to a monitored connection. There can be from zero to six connections that can be configured for each connection. In the figure *Tandem Connection Monitoring* on page 720, there are three different connections that are actually monitored. Carrier C, due to its location, can monitor three TCM levels as the ODU passes through its portion of the network.

In addition to monitoring maintenance signals, using the STAT field associated with each TCM level, the TCM connection also monitors the BIP-8 and BEI errors for each connection level. Maintenance signals are used to advertise upstream maintenance conditions affecting the traffic and errors provide an indication of the quality of service offered at each segment of the network, which provides a valuable tool for the user and carrier to isolate faulty sections of the network.

Forward Error Correction (FEC)

The ITU G.709 standard supports forward error correction (FEC) in the OTU frame and is the last part added to the frame before the frame is scrambled. FEC provides a method to significantly reduce the number of transmitted errors due to noise, as well as other optical phenomena that occur at high transmission speeds. This enables providers to support longer spans in between optical repeaters.

An OTU frame is divided into four rows. Each row is broken down into 16 sub-rows comprised of 255 bytes each, as shown in figure *Forward Error Correction* on page 722. A sub-row is composed of interleaved bytes. The interleave is executed so that the first sub-row contains the first overhead (OH) byte, the first payload byte and the first FEC byte, and so on for the remaining sub-rows of each row in the frame. The first FEC byte starts at position 240 for all sub-rows.

Glossary

G.709 Optical Transport Network (OTN)

The FEC uses a Reed-Solomon RS (255/239) coding technique. This means that 239 bytes are required to compute a 16-byte parity check. The FEC can correct up to eight (bytes) errors per sub-row (codeword) or detect up to 16 byte errors without correcting any. Combined with the byte interleave capability included in ITU G.709 implementation, the FEC is more resilient in regards to error burst, where up to 128 consecutive bytes can be corrected per OTU frame row.

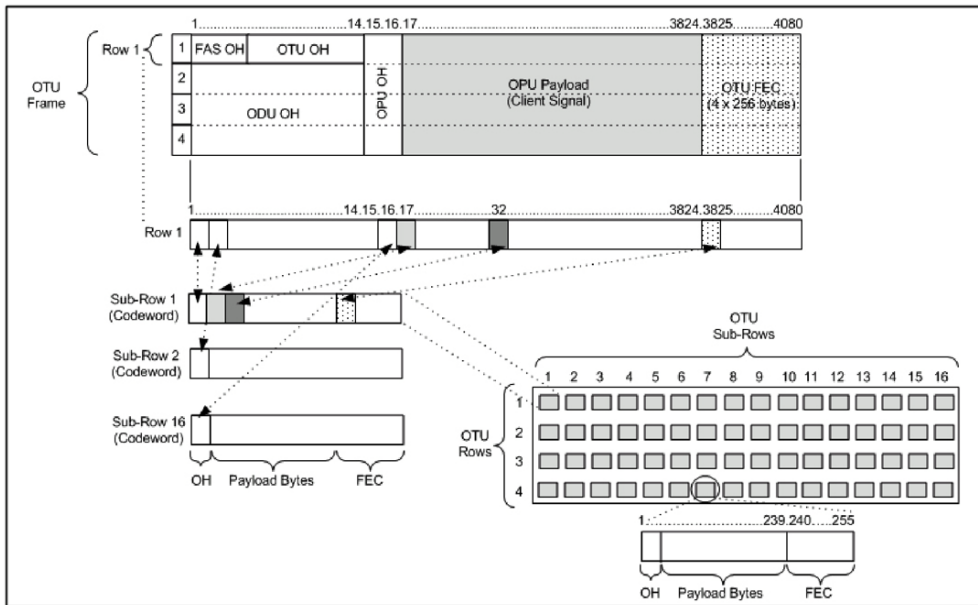

Forward Error Correction

ODU Multiplexing

The ODU multiplexer is a function that allows the multiplexing of ODU tributary signals into higher OTN signal rates. The G.709 standard supports 2 types of ODU multiplexer which can be classified as follows:

- Legacy architecture is based on multi-stage architecture to bring an ODUk client to a higher OTN interface rate. This multiplexer is identified by Payload Type 20 (PT 20).
- New architecture uses a single stage architecture to bring an ODUk client to any higher OTN interface rate. This method supports the ODUflex client signal. The multiplexer is identified by Payload Type 21 (PT 21).

Note: *Refer to the OTN BERT on page 45 or OTN-SONET/SDH BERT on page 47 for the ODU multiplexing capabilities.*

The multiplexing strategy is based on the concept of tributary slots, which is similar in concept to the SONET timeslot. The multiplexing of 4 ODU1 in one ODU2 is made by distributing the ODU1 structure in a repetitive sequence of 4 ODU2 Tributary slots, a similar strategy is used for ODU3 multiplexing where the repetitive sequence is made of 16 ODU3 tributary slots, refer to G.709 standard for detailed information.

Glossary

G.709 Optical Transport Network (OTN)

The main attributes of the ODU multiplexer functionality are as follows:

- The Asynchronous Mapping Procedure (AMP) is used for multiplexing the tributary signals; this method uses a modified Justification Control mechanism which has 2 positive Justification Control bytes and one negative Justification Control byte.
- The new multiplex method also supports the Generic Mapping Procedure as the Justification Control mechanism is still using the OPU OH JC bytes.
- The Multiplex Structure Identifier (MSI) provides information that is specific to each type of multiplexer provided.
- Can handle multiplex signals with frequency offset of +/- 20 ppm on every layer for the legacy architecture while the new architecture (using GMP) can handle frequency offset of +/-100 ppm.

ODUflex

ODUflex provides the capability to carry client payload of variable size with a container size of 1.244 Gbit/s granularity. An ODUflex (L) signal can be transported once multiplexed in an ODUk (H) signal, the multiplexer in this case handles tributary slots of 1.244 Gbit/s and has a Payload Type 21. The ODUflex function can be used to transport 2 signal categories mapped in ODTUk.ts using GMP:

➤ Ethernet in ODUflex over GFP-F signal

The Ethernet packets are mapped in GFP-F as specified in G.7041, the packets are processed as follows:

- The Start of Frame Delineation bytes are terminated
- Inter Frame Gaps bytes are terminated
- PCS coding is terminated
- GFP overhead bytes added

Since the PCS coding is terminated, it is not possible to transport the Ethernet Link status transparently but it is accommodated by the Forward Defect Indication (FDI) and Remote Defect Indication (RDI) alarms over GFP. The RDI is used to carry the Remote Fault alarm while the FDI is used to carry the Local Fault.

GFP-F provides rate adaptation between the incoming Ethernet signal and the outgoing OPUflex transport signal. This brings the fact that GMP is operated at a fixed Cm value close to the maximum server capacity.

➤ CBR over ODUflex signal

ODUflex can transport Constant Bit Rate signal (bulk filled Test pattern) as Client of the ODUflex CBR function. This CBR function needs a Pattern generator that can operate at a data rate specified by the user, the range of the available data rates is qualified by the Bandwidth management function.

Glossary

G.709 Optical Transport Network (OTN)

OTN Signal Rates

Rate	Signal
2.666057143 Gbit/s	OTU1
10.709225316 Gbit/s	OTU2
11.0491 Gbit/s	OTU1e
11.0957 Gbit/s	OTU2e
11.2701 Gbit/s	OTU1f
11.3176 Gbit/s	OTU2f
43.018413559 Gbit/s	OTU3
44.571 Gbit/s	OTU3e1
44.583 Gbit/s	OTU3e2
111.81	OTU4

Generic Framing Procedure (GFP)

Generic framing procedure (GFP), defined in ITU recommendation G.7041/Y.1303, is a framing mechanism to transport packet-based client signals, such as Ethernet, Fibre Channel, ESCON, FICON, over fixed-data-rate optical channels. As such, GFP provides a single, flexible mechanism to map these client signals into SONET/SDH and OTN networks, as shown in figure below.

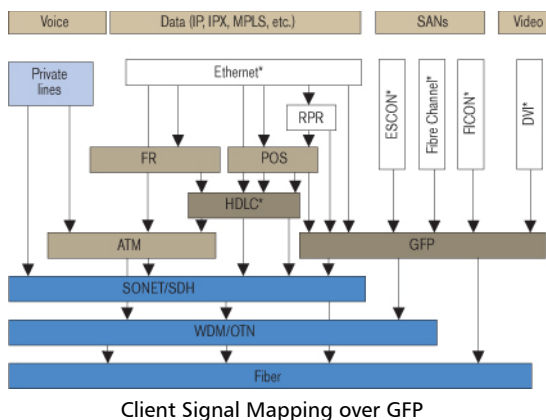

Prior to the introduction of GFP, several methods had been used to transport packet services over SONET/SDH networks. The first method was Asynchronous Transfer Mode (ATM) Adaptation Layer 5 (AAL 5) over SONET/SDH. ATM is a very efficient switching and multiplexing technology, whose transfer rates scale with SONET/SDH rates. However, ATM does not make the most efficient use of bandwidth because the payload data is separated into groups of 48 bytes, called cells, with an additional 5-byte header of software overhead. It became immediately apparent that almost 10 % of the bandwidth would be lost. In addition, certain types of data required even more ATM overhead.

Glossary

Generic Framing Procedure (GFP)

Other methods have focused on using point-to-point protocol (PPP). The IP traffic coming to an Ethernet port is encapsulated over a PPP link and multiple ports can be encapsulated over multilink PPP (ML-PPP) links. By using an HDLC framing, the PPP traffic is transported over the SONET/SDH payload. These methods have been standardized within the IETF through the following Requests for Comments (RFC): RFC 1662, RFC 1990 and RFC 2615. The ITU-T expanded this work by specifying the use of LAPS (very similar protocol to PPP/HDLC) and specifying IP over LAPS in X.85/Y.1321 and Ethernet over LAPS in X.86/Y.1323. All these methods for encapsulating traffic suffer from the weaknesses of HDLC framing; i.e., limited protection from frame corruption and the introduction of variable packet sizes because of its trailer.

GFP has been standardized to better optimize the transport of Ethernet and other data services over SONET/SDH networks, taking into account both the pros and cons of ATM and PPP/HDLC and leveraging two new emerging SONET/SDH capabilities, VCAT and LCAS, that will be discussed later in this document.

GFP Mapping

Two types of mapping are currently available for GFP: framed-mapped (GFP-F) and transparent-mapped (GFP-T), whose mappings keep the same basic frame structure, as will be shown in the next sections. The decision on which mode to use is dependent on the underlying service to be transported.

- **Frame-Mapped GFP (GFP-F):** mapping mechanism in which one client signal frame is received and mapped in its entirety into one GFP frame. Therefore, with this adaptation mode, the GFP-F frame size is variable as it is directly related to the incoming client payload. In fact, with GFP-F, the entire client frame must be buffered in order to determine its length. GFP-F is usually used to support Layer 2 frames like Ethernet MAC that are tolerant to some latency. The ITU G.7041 defines the following frame-mapped user payloads supported through GFP-F:
 - Frame-Mapped Ethernet
 - Frame-Mapped PPP
 - Frame-Mapped Multiple Access Protocol over SDH (MAPOS)
 - Frame-Mapped IEEE 802.17 Resilient Packet Ring
 - Frame-Mapped Fibre Channel FC-BBW
- **Transparent-Mapped GFP (GFP-T):** mapping mechanism that facilitates the transport of 8B/10B block-coded client signals like Gigabit Ethernet (GbE), Fibre Channel, ESCON, FICON, and DVB-ASI. With GFP-T, individual characters of a client signal are decoded from the client signal and then mapped into fixed-size GFP frames (64B/65B coded superblocks). This approach avoids the buffering of an entire client frame before it can be mapped into a GFP frame, which reduces latency and in turn makes it ideally suited for SAN applications that require very low transmission latency.

Glossary

Generic Framing Procedure (GFP)

The figure *GFP-T vs GFP-F Features* below provides a functional comparison between GFP-F and GFP-T, while figure *GFP-T vs. GFP-F Frames* below provides a comparison of the GFP frames for both modes.

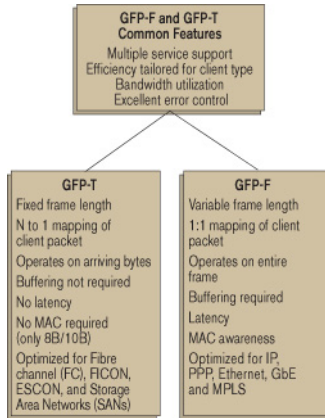

GFP-T vs GFP-F Features

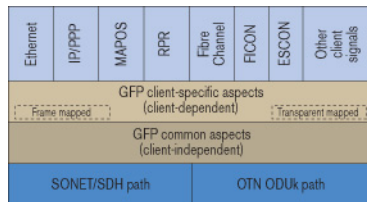

GFP-T vs. GFP-F Frames

Functionally, GFP consists of both common and client-specific aspects. Common GFP aspects apply to all GFP-adapted traffic (i.e., both GFP-F and GFP-T) and cover functions such as packet data unit (PDU) delineation, data link synchronization and scrambling, client PDU multiplexing, and client-independent performance monitoring. Client-specific aspects of GFP cover issues such as mapping of the client PDU into the GFP payload, client-specific performance monitoring, as well as operations, administration, and maintenance (OA&M). This is illustrated in figure *Client Signal Mapping over GFP* on page 727.

GFP Frame Structure

As illustrated in figure below, Two basic GFP frame types have been defined: GFP client frames and GFP control frames. GFP client frames are categorized into two types: client data frames (CDFs) and client management frames (CMFs). CDFs are used to transport the client data, while CMFs are used to transport information associated with the management of the client signal or GFP connection.

As for GFP control frames, at this time, only one category has been defined by the standard so far; i.e., GFP idle frames.

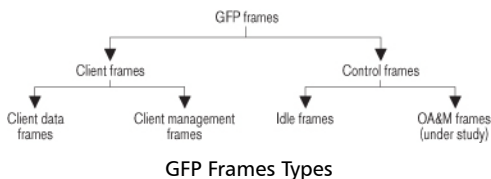

Glossary

Generic Framing Procedure (GFP)

The GFP generic frame structure is presented in figure below.

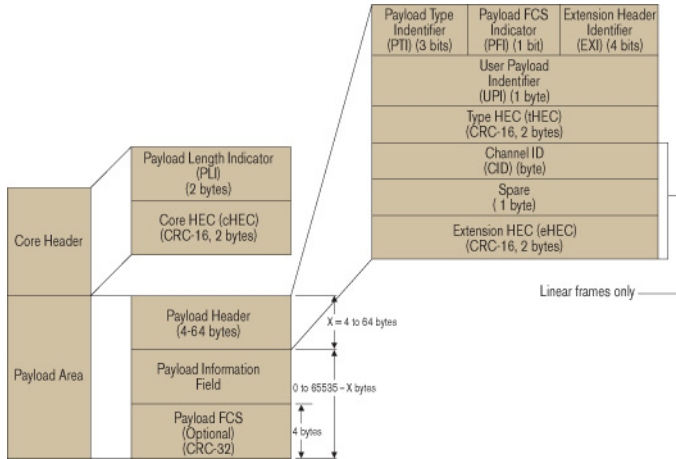

GFP Generic Frame Structure

Each GFP frame type consists of three main components: the core header, the payload header, and the payload information field.

The core and payload headers form the GFP header, whereas the payload information field represents the customer traffic carrying the data services. The payload header carries information about the payload type (i.e., Ethernet, Fibre Channel, etc.) that it is carrying, while the core header carries information about the size of the GFP frame itself.

Each header contains a header error correction (HEC) calculation, allowing for the correction of single errors; that is, any errors that occur in the core header or in the payload header can potentially be corrected by the HEC, through the network element. This creates a very robust mapping scheme, which ensures that GFP frames can get transported across a network without customer traffic loss.

➤ **Core Header**

The GFP core header consists of a two-octet length field, specifying the length of the GFP frame's payload area in octets, and a two-octet field containing a CRC-16 error-check code.

- **Payload Length Indicator (PLI):** The PLI is a two-byte field indicating the size in bytes of the GFP payload area. It indicates the beginning of the next GFP frame in the incoming bit-stream as an offset from the last byte in the current GFP core header. PLI values in the range of 0 to 3 are reserved for GFP internal use and are referred to as GFP control frames. All other frames are referred to as GFP client frames.
- **Core HEC (cHEC):** The cHEC is a two-byte field containing a cyclic redundancy check (CRC-16) sequence that protects the integrity of the core header. The cHEC sequence is computed over the core header bytes using standard CRC-16. The CRC-16 enables both single-bit error correction and multibit error detection.

➤ **Payload Header**

The payload header is a variable-length area, 4 to 64 octets long, intended to support data-link management procedures specific to the transported client signal. The payload header contains two mandatory fields, the Type field and Type Header Error Correction (tHEC) field. The payload header also supports an additional variable number of subfields referred to, as a group, as the extension header.

- **Payload Type Identifier (PTI):** A three-bit subfield that identifies the type of GFP client frame. The following table lists the currently defined user frames.

PTI	Description
000	Client Data Frame
100	Client Management Frame
Others	Reserved

Glossary

Generic Framing Procedure (GFP)

- **Payload FCS Indicator (PFI):** A one-bit subfield indicating the presence (1) or absence (0) of the payload FCS field. The following table lists the currently defined PFI values.

PFI	Description
0	FCS Absent
1	FCS Present

- **Extension Header Identifier (EXI):** A four-bit subfield identifying the type of GFP extension header. Three kinds of extension headers are currently defined:

EXI	Description	Function
0000	Null Extension Header	Indicates that no extension header is present.
0001	Linear Extension Header	A two-octet extension header that supports sharing of the GFP payload across multiple clients in a point-to-point configuration. The linear extension header consists of an eight-bit channel ID (CID) field, used to indicate one of 256 communication channels (i.e. clients) at a GFP termination point, and an eight-bit spare field reserved for future use.
0010	Ring Extension Header	The use of this field is under consideration. Similar to linear, the current proposal being considered is to allow the sharing of the GFP payload across multiple clients; however, this would only apply to ring configurations.
0011 to 1111	Reserved	

- **User Payload Identifier (UPI):** An eight-bit field identifying the type of payload conveyed in the GFP payload information field:

UPI	Client Data	Client Management
0000 0000 1111 1111	Reserved and not available	Reserved
0000 0001	Mapped Ethernet Frame	Client Signal Fail (Loss of Client Signal)

UPI	Client Data	Client Management
0000 0010	Mapped PPP Frame	Client Signal Fail (Loss of Character Synchronization)
0000 0011	Transparent Fibre Channel	Client Defect Clear Indication (DCI)
0000 0100	Transparent FICON	Client Forward Defect Indication (FDI)
0000 0101	Transparent ESCON	Client Reverse Defect Indication (RDI)
0000 0110	Transparent GbE	
0000 0111	Reserved for future use	
0000 1000	Frame-Mapped IEEE 802.17 Resilient Packet Ring	
0000 1011	Frame-Mapped Fibre Channel FC-BBW	
0000 1100	Asynchronous Transparent Fibre Channel	
0000 1101	Framed MPLS Unicast	
0000 1110	Framed MPLS Multicast	
0000 1111	Framed IS-IS	
0001 0000	Framed IPv4	
0001 0001	Framed IPv6	
0001 0010	Framed DVD-ASI	
0001 0011	Framed 64B/66B Ethernet	
0001 0100	Framed 64B/66B Ethernet Ordered Set	
0001 0101 through 1110 1111	Reserved for future standardization	
1111 0000 through 1111 1110	Reserved for proprietary use	
0000 0110 through 1101 1111		Reserved for future use
1110 0000 through 1111 1110		Reserved for proprietary use

Glossary

Generic Framing Procedure (GFP)

- **Type HEC (tHEC) Field:** A two-octet field that contains a CRC-16 sequence to protect the integrity of the type field. The tHEC sequence is computed over the core header bytes using standard CRC-16. As with the cHEC, CRC-16 enables both single-bit error correction and multibit error detection.
- **Channel Identifier (CID):** A one-byte field that is only available when the EXI field is configured to Linear. The CID byte is used to indicate one of 256 communication channels at a GFP termination point.
- **Spare:** A one-byte field that is only available when the EXI field is configured to Linear. This field is reserved for future use.
- **Extension HEC (eHEC):** A two-byte field that contains a CRC-16 check sequence that protects the integrity of the contents of the extension. CRC-16 enables both single-bit correction and multibit error detection.

The figure below explains how (in GFP-F) the transmitter encapsulates one entire frame of the client data.

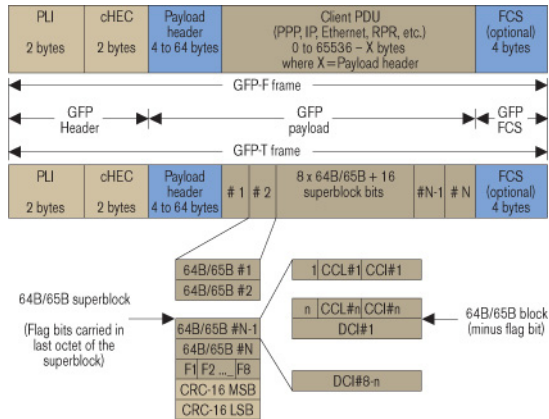

GFP-F vs. GFP-T Frame Structure

► **Payload Information Field**

The payload area (also referred to as payload information field) contains the framed client signal. This variable-length field may include from 0 to 65,535 – X octets, where X is the size of the payload header (including the extension header, if present) and the payload FCS field (if present).

Figure *GFP-T vs. GFP-F Frames* on page 730 shows the GFP-T and GFP-F frame structures. As shown, Both GFP-T and GFP-F frame types share a common core header, payload header, and payload FCS (optional), and they differ in the way in which the client is mapped into this payload area.

► **Payload FCS (pFCS)**

This is an optional four-octet-long frame-check sequence. It contains a CRC-32 check sequence that is designed to validate the entire content of the payload area. The FCS field presence is signalled by the PFI bit located in the Type field of the payload header. The FCS does not correct any errors; it just indicates the presence of error(s).

In GFP-F, the transmitter encapsulates one entire frame of the client data into one GFP frame. In this case, the basic frame structure of a GFP client frame is used, including the required payload header.

In GFP-T, however, rather than buffering an entire client-data frame, the individual characters of the client signal are demapped from the client block codes and then mapped into periodic fixed-length GFP frames. The transparent GFP client frame uses the same structure as the frame-mapped GFP, including the required payload header.

Glossary

Generic Framing Procedure (GFP)

GFP Summary

GFP has been standardized to better optimize the transport of Ethernet and other data services over SONET, taking into account both the pros and cons of ATM and PPP/HDLC framing mechanisms. As described in this section, GFP represents a robust mapping mechanism that allows for the mapping of multiple client-data types into SONET/SDH payload (SPEs). This technology has been embraced by network equipment and service providers as it provides an efficient way of providing interoperable data-services transport over the existing SONET/SDH install base. The versatility provided by GFP allows SONET/SDH networks to offer transport services for a multiple of services, as shown in figure below.

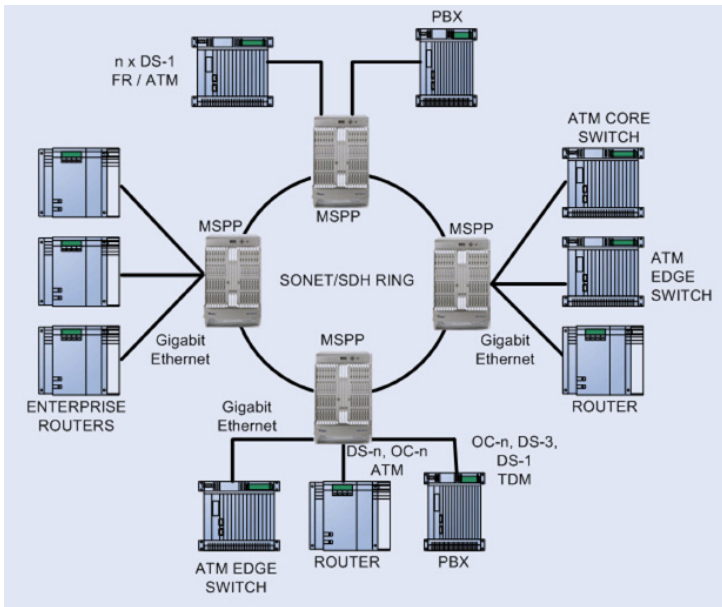

Multiservice SONET/SDH Network

MPLS Labels

The MPLS labels are listed in the following table.

Label	Description
0	IPv4 explicit null
1	Router alert
2	IPv6 explicit null
3	Implicit null
14	OAM alert
4 to 13, and 15	Unassigned
16 to 1048575	Label ID

OBSAI

Overview

Traditional mobile installations are bulky (use thick coaxial cables) and require a lot of power to operate (there is a huge power loss in the coaxial cabling which often requires the use of Tower Mounted Amplifiers) as outlined in the following figure.

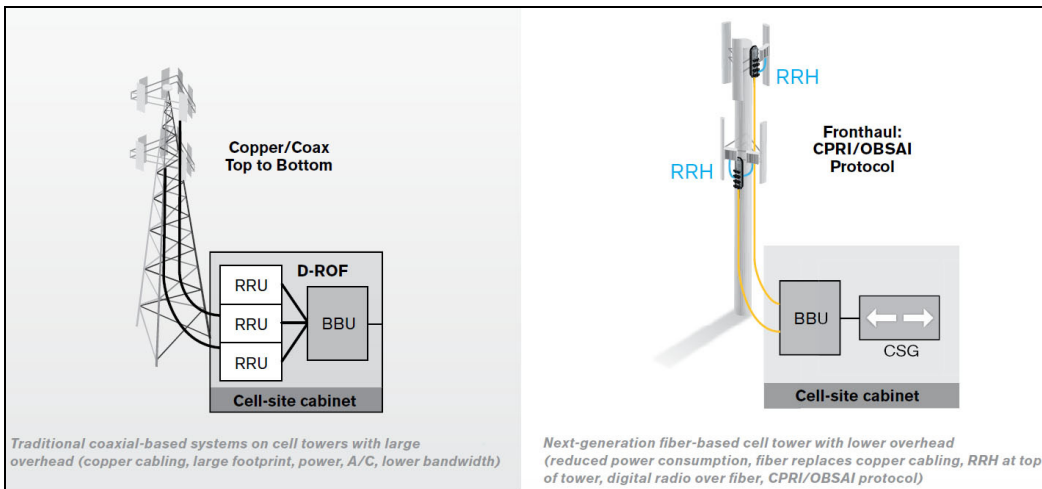

Pressures on the Mobile Network Operators (MNO) to reduce their capital, operational cost, and increase coverage are at the heart of a revolution in the mobile network. To address the situation, a concept of decomposition of the radio base station has been developed where the radio basic functions and its ability to transmit and receive radio modulated signals are separated. In such a distributed environment, a protocol is required to maintain synchronization and management capabilities as well as transporting the user traffic between the simplified Base Transceiver Station (BTS) and its Remote Radio Head (RRH).

This protocol called Open Base Station Architecture Initiative (OBSAI) separates a traditional radio base station configuration into two separate elements: Base Transceiver Station (BTS) and Remote Radio Head (RRH). The BTS processes the digital baseband radio information and performs the control of the RRH. The RRH converts the digital radio information into radio frequency signals transported over the air interface (antenna). The BTS and RRH are interconnected by a point-to-point link. This link carries the OBSAI protocol and is known in the industry as the fronthaul as opposed to the backhaul that is the WAN bringing the network traffic to the base station.

The OBSAI link can be extended over several kilometers as it uses fiber optics. In fact it can be deployed up to 40 km although most field installations at the moment of this writing are below 10 km.

The OBSAI BTS System Reference Document defines multiple Reference Points. The Reference Point 3 Specification mainly defines the physical to the application layers providing an opportunity for larger interoperability between vendors. However, field experience suggests that the interoperability is pretty much limited to the physical and data link layers.

OBSAI RP3-01 System Architecture

OBSAI remotely locates the RRH from the BTS. This means that the RRH must be controlled, managed and synchronized from the BTS in addition to transporting the User information (Voice and user application data) and all that on the same digital link, the RP3-01. As such, an OBSAI interface is composed of 3 communication flows sent in the same optical fiber in the form of continuous messages as illustrated in the following diagram.

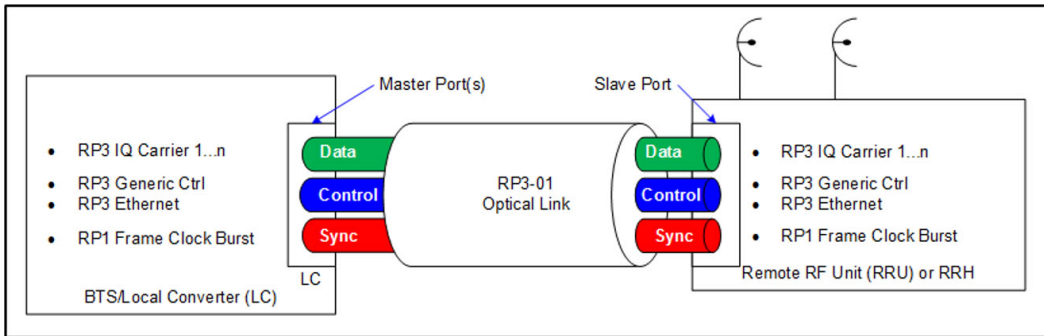

The OBSAI link parameter alignment setup is driven by two paired TX and RX state machines; one pair located on the BTS acts as a Master and the other located at the RRH acts as a Slave. The Master initiates the negotiation procedure necessary to achieve this alignment.

- Data: User Data Messages (IQ Data) which represents the voice and data information that is exchanged by End-User Equipment
- Control: Call Processing/OAM&P messages (Generic Ctrl and RP3 Ethernet messages)
- Synchronization: Frame synchronization messages

OBSAI Protocol Stack

The OBSAI RP3 Protocol Stack revolves around the 4 layers: Physical Layer, Data Link Layer, Transport Layer and Application Layer as outlined in the following diagram.

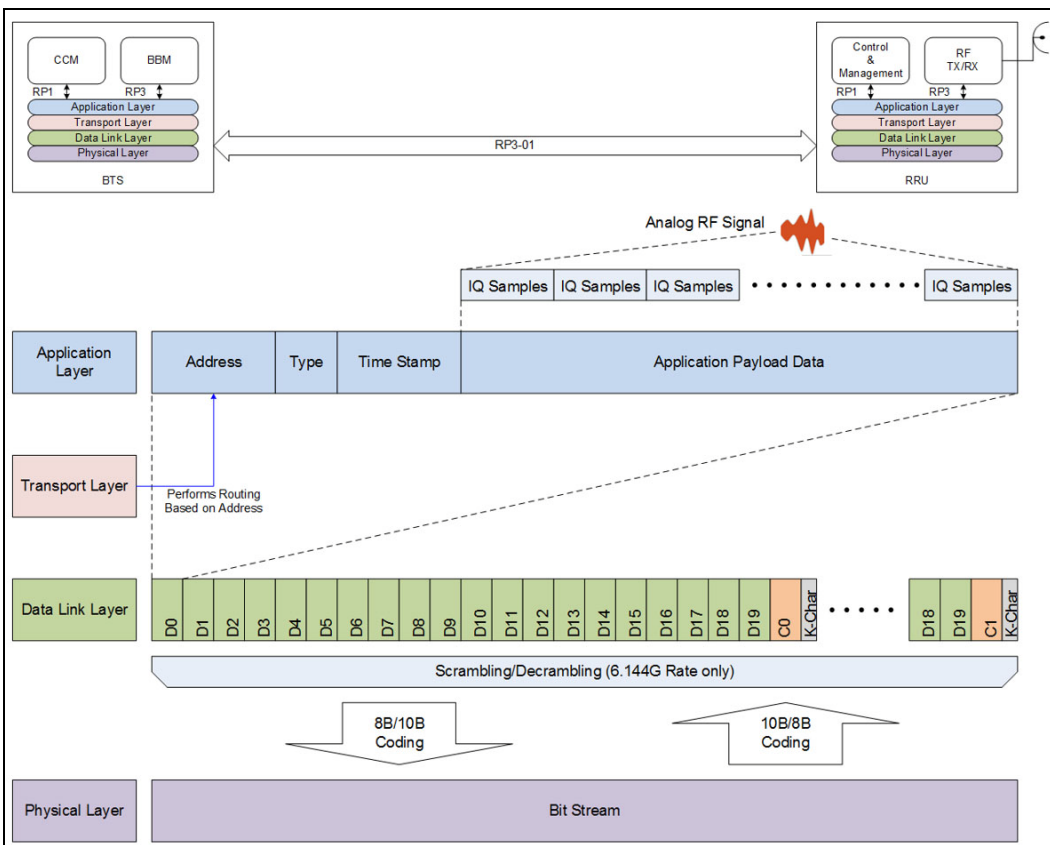

Glossary

OBSAI

- Application Layer: Provides message sampling and mapping based on payload type (ex: WCDMA/FDD, LTE, GSM/EDGE and 802.16 also known as Wi-Max).
- Transport Layer: End-to-End delivery message including routing based on RP3 Address defined in the messages.
- Data Link Layer:
 - Message framing and link synchronization.
 - Scrambling/Descrambling (6.144G only).
- Physical Layer:
 - 8B/10B Coding/Decoding (or 10B/8B Coding).
 - Create serial bit stream.
 - Transmit/Receive bit stream on the interface..

Physical Interface

OBSAI offers 4 rates based on a multiple of 768 Mbit/s. All OBSAI rates use 8B/10B line coding. Scrambling is mandatory for the 6.1Gbit/s rate. When using OBSAI with Framed L2, the line rate and scrambling are normally negotiated following the operation of the TX and RX state machines at the BTS and RRH nodes.

Multiple (i)	Rate	Line Coding	Scrambling
1x	768 Mbit/s	8B/10B	None
2x	1.536 Gbit/s		
4x	3.072 Gbit/s		
8x	6.144 Gbit/s		Configurable (enabled by default)

SONET/DSn/SDH/PDH

SONET/DSn/SDH/PDH Nomenclature

The GUI will use the International or European nomenclature based on the SONET and SDH software options installed on the module.

Software option	Nomenclature
SONET only	International
SDH only	European
SONET and SDH	International

Signal Rates

Rate	SONET/DSn	SDH/PDH	
		International	European
1.544 Mbit/s	DS1	-	1.5M
2.048 Mbit/s	-	E1	2M
8.448 Mbit/s	-	E2	8M
34.368 Mbit/s	-	E3	34M
44.736 Mbit/s	DS3	-	45M
51.84 Mbit/s	OC-1	STM-0	52M
139.264 Mbit/s	-	E4	140M
155.52 Mbit/s	OC-3	STM-1	STM-1
622.08 Mbit/s	OC-12	STM-4	STM-4
2.48832 Gbit/s	OC-48	STM-16	STM-16
9.95328 Gbit/s	OC-192	STM-64	STM-64
39.81312 Gbit/s	OC-768	STM-256	STM-256

Glossary

SONET/DSn/SDH/PDH

SONET/SDH High and Low Order Path Nomenclature

Path Type	SDH	SONET
High Order	AU-3	STS-1
	AU-4	STS-3c
	AU-4-4c	STS-12c
	AU-4-16c	STS-48c
	AU-4-64c	STS-192c
	AU-4-256c	STS-768c
Low Order	TUG-3	-
	TUG-2	VTG
	TU-11	VT1.5
	TU-12	VT2
	TU-3	-

SONET/SDH Alarms and Errors Nomenclature

Layer	SONET	SDH
Physical	BPV/CV	CV
Section / Regenerator Section	LOF-S	RS-LOF
	SEF	RS-OOF
	TIM-S	RS-TIM
	FAS-S	RS-FAS
	B1	B1
Line / Multiplex Section	AIS-L	MS-AIS
	RDI-L	MS-RDI
	B2	B2
	REI-L	MS-REI
High Order Path	AIS-P	AU-AIS
	LOP-P	AU-LOP
	H4-LOM	H4-LOM
	PDI-P	-
	RDI-P	HP-RDI
	ERDI-PCD	ERDI-CD
	ERDI-PPD	ERDI-PD
	ERDI-PSD	ERDI-SD
	PLM-P	HP-PLM
	UNEQ-P	HP-UNEQ
	TIM-P	HP-TIM
	B3	B3
	REI-P	HP-REI

Glossary

SONET/DSn/SDH/PDH

Layer	SONET	SDH
Low Order Path	AIS-V	TU-AIS
	LOP-V	TU-LOP
	RDI-V	LP-RDI
	ERDI-VCD	ERDI-CD
	ERDI-VPD	ERDI-PD
	ERDI-VSD	ERDI-SD
	RFI-V	LP-RFI
	UNEQ-V	LP-UNEQ
	TIM-V	LP-TIM
	PLM-V	LP-PLM
	BIP-2	BIP-2
	REI-V	LP-REI

SONET Numbering Convention

The module supports the Timeslot (default) and hierarchical two-level numbering conventions as per GR-253.

Hierarchical Notation:

The module supports numbering SONET high order path STS-1s and STS-3c using the two-level “STS-3#,STS-1#” convention in an OC-N. For example: STS-1 [2,3].

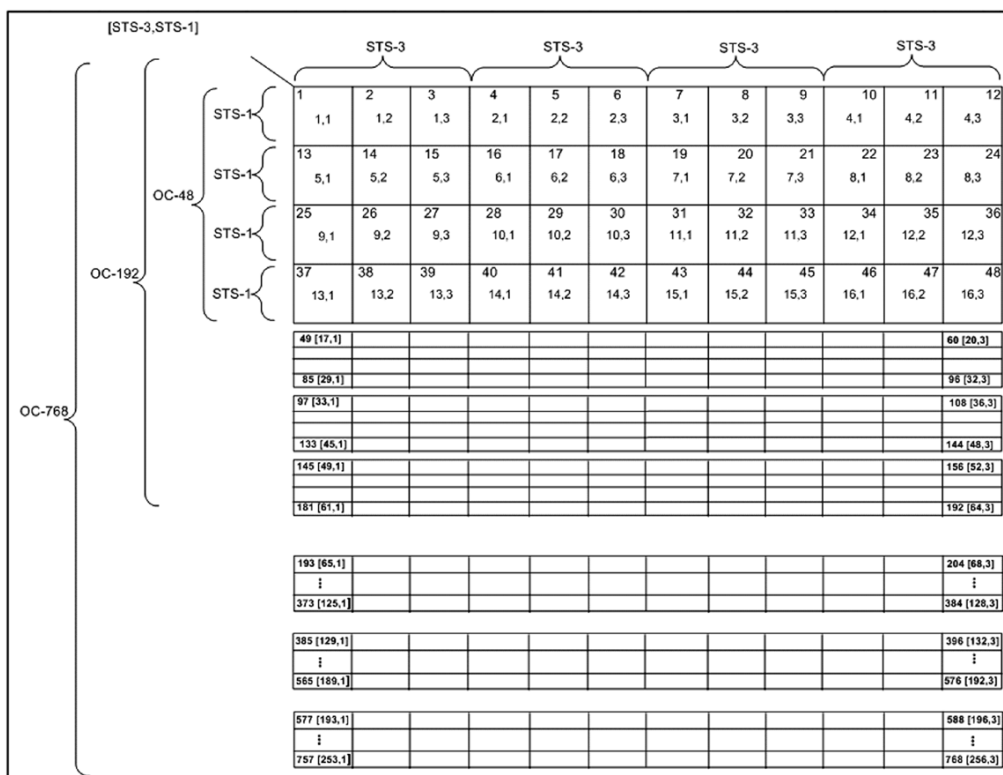

Glossary

SONET/DSn/SDH/PDH

The module supports numbering SONET low order path using the two-level “VTGroup#,VT#” convention for numbering VTs within an STS-1. For example: VT1.5 [1,3], VT2 [3,2], VT6 [6,1].

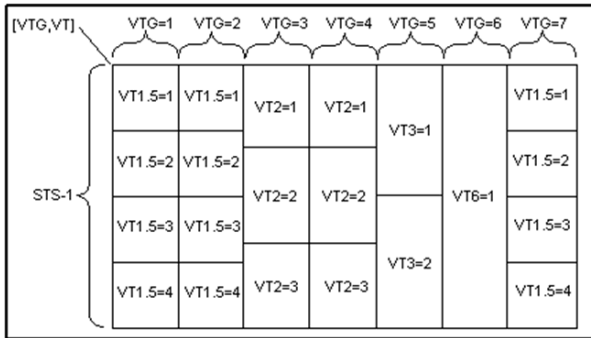

The module supports numbering SONET high order path STS-nc within an OC-N using the two-level “STS-3#,STS-1#”. For example: STS-12c [5,1].

SDH Numbering Convention

As per ITU G.707, the high order paths are defined using a 2 to 5 level convention E,D,C,B,A depending on the rate of the STM-n used.

- E: the AUG-64 are numbered 1 to 4
- D: the AUG-16 are numbered 1 to 4
- C: the AUG-4 are numbered 1 to 4
- B: the AUG-1 are numbered 1 to 4
- A: the AU-3 are numbered 1 to 3

Naming is as follows for each of the following rates:

- [E,D,C,B,A] for STM-256
- [D,C,B,A] for STM-64
- [C,B,A] for STM-16
- [B,A] for STM-4
- [0] for AU-4 in STM-1
- [A] for AU-3 in STM-1

		B=1			B=2			B=3			B=4			
E=1	D=1	C=1	1 A=1	2 A=2	3 A=3	4 A=1	5 A=2	6 A=3	7 A=1	8 A=2	9 A=3	10 A=1	11 A=2	12 A=3
		C=2	13 A=1	14 A=2	15 A=3	16 A=1	17 A=2	18 A=3	19 A=1	20 A=2	21 A=3	22 A=1	23 A=2	24 A=3
		C=3	25 A=1	26 A=2	27 A=3	28 A=1	29 A=2	30 A=3	31 A=1	32 A=2	33 A=3	34 A=1	35 A=2	36 A=3
		C=4	37 A=1	38 A=2	39 A=3	40 A=1	41 A=2	42 A=3	43 A=1	44 A=2	45 A=3	46 A=1	47 A=2	48 A=3
	D=2		[1,2,1,1,1]											[1,2,1,4,3]
			[1,2,4,1,1]											[1,2,4,4,3]
			[1,3,1,1,1]											[1,3,1,4,3]
			[1,3,4,1,1]											[1,3,4,4,3]
	D=3		[1,4,1,1,1]											[1,4,1,4,3]
			[1,4,4,1,1]											[1,4,4,4,3]
			[2,1,1,1,1]											[2,1,1,4,3]
			[2,4,4,1,1]											[2,4,4,4,3]
	E=2		⋮											⋮
			[2,4,4,1,1]											[2,4,4,4,3]
	E=3		[3,1,1,1,1]											[3,1,1,4,3]
			[3,4,4,1,1]											[3,4,4,4,3]
E=4		⋮											⋮	
		[4,4,4,1,1]											[4,4,4,4,3]	

Glossary

SONET/DSn/SDH/PDH

The low order paths are defined using a 2 or 3 level convention K,L,M depending on the rate of the AU-4 or AU-3 used to multiplex the low order signals.

- K: the TUG-3 are numbered 1 to 3
- L: the TUG-2 are numbered within the TUG-3 0 or from 1 to 7
- M: the TU-2, TU-12, TU-11 are numbered within the TUG-2 1, 1 to 3, 1 to 4 respectively

Examples for AU-4 (3 level convention)

TU-3: [K,0,0]

TU-2: [K,L,0]

TU-12:[K,L,M] where M = 1 to 3

TU-11:[K,L,M] where M = 1 to 4

Example for AU-3 (2 level convention)

TU-2: [L,0]

TU-12: [L,M] M is numbered 1 to 3

TU-11: [L,M] M is numbered 1 to 4

The GUI Grid indicates the TUG-2 [x] and TUG-3 [x] values.

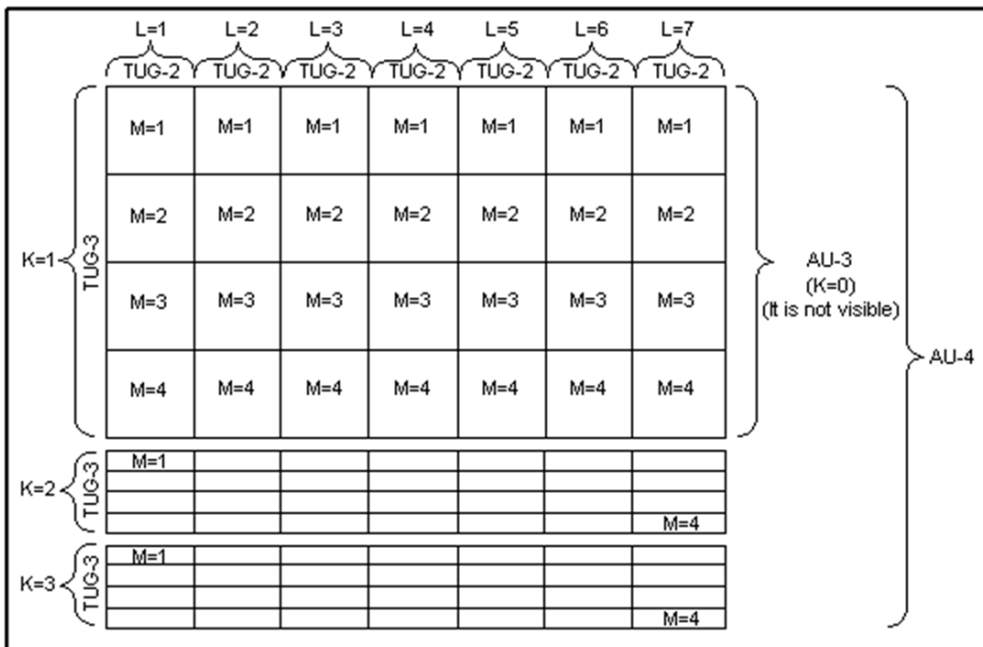

DSn/PDH Numbering Convention

The DS1 numbering in DS3 shall be numbered with respect to the DS2 muxing [DS2,DS1]. For example a DS3 has 7 DS2 and a DS2 has 4 DS1, so an example would be for a DS1 number [3,2]. The DS3 shall have a single number to represent its position. That is [1] all the time whether it is used in an STS-1 or it is the DS3 electrical interface.

The PDH do not have special grouping of the E1, E2, E3 or E4. This means that the PDH has a single number. For example E1 number 2 shall be number [2].

The E1 in DS3 via G.747 numbering uses the naming [DS2,E1]. However in the grid the label shall adapt itself to DS2 [x] or 6.3M [x] (where x = 1 to 7) with respect to the interface standard used: European or International.

SyncE

Synchronous Ethernet or SyncE enables a traceable network timing reference frequency to be distributed node-by-node across a chain of Ethernet devices (SyncE compliant devices only). The network timing reference is typically hierarchically traceable to a Primary Reference Source/Clock (PRS/PRC) in a unidirectional flow. Any node in the chain not compliant to SyncE automatically terminates the synchronization propagation but this does not impact the flow of traffic.

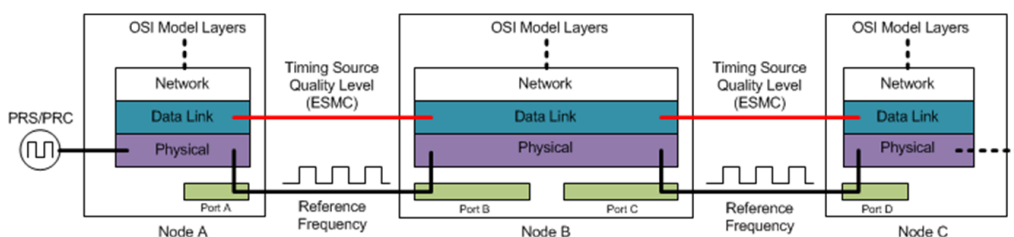

The Physical Layer carries the clock frequency and the Data Link layer carries the Quality Level (QL) associated to the transported frequency via Synchronization Status Messaging (SSM) embedded in the Ethernet Synchronization Message Channel (ESMC). The QL is transported via Information and Event PDUs typically transmitted at a rate of 1 frame per second but this rate can vary between 1 to 10 messages per second to respect the slow protocol rules. The Information PDU is used as heart-beat for the channel while one Event PDU is transmitted asynchronously to the Information PDU upon change of the QL value. Following this change, the Information PDU is also adjusted to match the new QL.

Glossary

SyncE

In order for an Ethernet interface to be considered Synchronous Ethernet compliant it needs to be upgraded as shown in the following diagram. In addition to supporting the ESMC channel, this upgrade consists in allowing the recovered clock from the CDR to be propagated to a function called the Ethernet Equipment Clock (EEC).

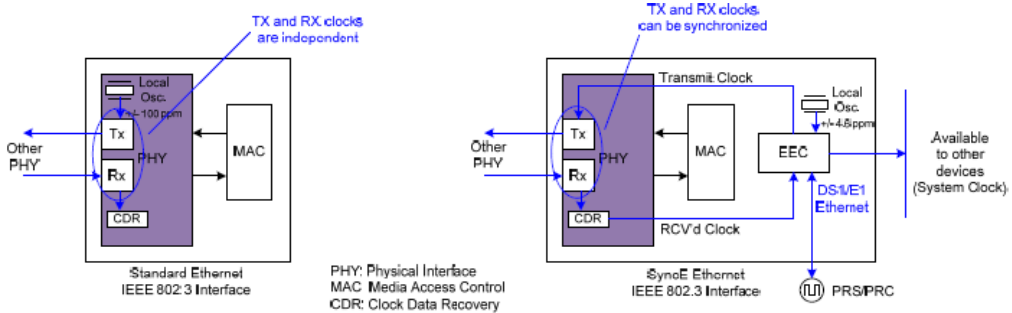

The EEC is present in a network element (NE) to determine which port should be used to distribute the frequency to other port(s) in the NE as well as what QL value to transmit over the ESMC to other network element in the network synchronization chain. The actual selection decision is based on the QL value received from the various port(s) in the NE. If none are valid the EEC is equipped with a better oscillator than a standard Ethernet interface to provide synchronization (Holdover mode). Typically the highest QL value is selected among the nominated sources within the network element.

Unicast/Multicast Addresses for Ethernet OAM

Unicast or multicast address can be used for most of S-OAM functions.

- Unicast addresses a unique destination address of the MEP.
- Multicast Class 1 addresses all MEPs in the MEG. The address value is 01-80-C2-00-00-3x, where x represents the MEG/MD Level.
- Multicast Class 2 addresses all MIPs and MEPs in the MEG. The address value is 01-80-C2-00-00-3y, where y represents the MEG/MD Level + 8.

The following table specifies which address type is used for each frame type.

Frame Type	Unicast	Multicast		Frame Type	Unicast	Multicast	
		Class 1	Class 2			Class 1	Class 2
CCM	X	X		LMM	X	X	
LBM	X	X		LMR	X		
LBR	X			SLM	X	X	
LTM			X	SLR	X		
LTR	X			AIS	X	X	
TST	X	X		CSF	X	X	
DMM	X	X		LCK	X	X	
DMR	X						

Glossary

VLAN ID and Priority

VLAN ID and Priority

Special VID values (IEEE Std 802.1Q-1998)

ID	Description
0	The null VLAN ID. Indicates that the tag header contains only user priority information; no VLAN identifier is present in the frame. This VID value must not be configured as a PVID, configured in any Filtering Database entry, or used in any Management operation.
1	The default PVID value used for classifying frames on ingress through a Bridge Port. The PVID value can be changed on a per-Port basis.
4095	Reserved for implementation use. This VID value shall not be configured as a PVID, configured in any Filtering Database entry, used in any Management operation, or transmitted in a tag header.

VLAN Priority

0	000 - Low Priority	4	100 - High Priority
1	001 - Low Priority	5	101 - High Priority
2	010 - Low Priority	6	110 - High Priority
3	011 - Low Priority	7	111 - High Priority

C Remote ToolBox

Overview

The **Remote ToolBox** application allows remotely controlling a module installed on a platform using a remote PC. Remote users are connected to the platform using an Ethernet connection.

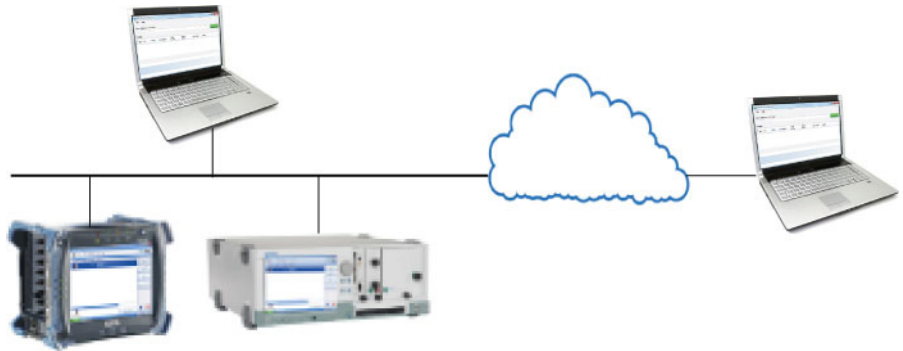

Note: *The remote control feature has to be enabled for the module on its specific slot on the platform. Refer to the Controlling Modules Remotely section from the platform user guide for more information.*

The **Remote ToolBox** allows starting one or several module application(s). Once a module application is started, the application is independent and does not require the **Remote ToolBox** anymore. Thus, the **Remote ToolBox** application can be closed or can be disconnected from the platform using the **Disconnect** button without affecting the running remote module applications.

Remote ToolBox

Overview

A remote module application offers the same level of control as if the module is locally controlled with the following behaviors.

➤ Multi-user behaviors:

Up to five connections including the local and/or remote sessions are allowed per module. Beyond five connections, the performance to service the connections may decrease.

Each user is able to individually navigate through the module application without affecting the other users. However, any changes to the operation of the test (**Start, Stop, Reset**, etc.) or to any test parameter will be applied to all users.

➤ File location behaviors:

The save, load, report, and data capture functions are associated with the location of the session initiated; for Remote ToolBox it will be on the local PC. The files are not duplicated on the platform platform.

➤ The **Save/Load** configurations are saved in the following folder:
Document\88000-PowerBlazer\Configuration

➤ The **Reports** are saved in the following folder:
Document\88000-PowerBlazer\Reports

If a report is being generated, no user will be able to start the test case until the report generation is completed.

➤ The **Data Capture** files are saved in the following folder:
Document\88000-PowerBlazer\CaptureData

If a capture file is being generated, all users will be able to stop the capture but only the user that initiates the capture will be able to see the captured data file after generation.

Remote ToolBox Installation

Requirements

The following system requirements must be met before installing the **Remote ToolBox** software.

- 10 or 10/100 Mbit/s network interface card.
- Windows XP/Vista/7/8/10 operating system.

Note: *Some Windows applications such as PDF reader, Excel, etc. may be required to open the generated reports.*

Installation

Download the **Remote ToolBox** application from **EXFO STORE** at www.exfo.com. Run the **Setup.exe** application and follow the on-screen instructions to complete the installation.

A shortcut of the **EXFO Remote ToolBox** will be created on the PC desktop.

Starting and Using the Remote ToolBox Application

Start the **Remote ToolBox** application, either by using the desktop **EXFO Remote ToolBox** shortcut, or by clicking on the **EXFO Remote ToolBox** application from **All Programs - EXFO**.

File Menu

The **File-Exit** menu allows quitting the **Remote ToolBox** application.

Help Menu

The **Help** menu displays the help information about the **Remote ToolBox** application.

Server Address or Host Name

Allows entering the platform IP address or the Host Name. The IP address format is IPv4 (xxx.xxx.xxx.xxx) where xxx are values from 0 to 255. For example: 192.168.1.1.

To find the IP address of the platform, refer to the platform user guide.

Connect/Disconnect Button

- **Connect** establishes the connection with the platform specified by the selected IP address or the Host Name.
- **Disconnect**, closes the connection with the selected platform allowing to establish a connection with another platform.

Modules

Once connected to the platform, lists the modules installed on the platform regardless of the remote control feature being enabled or not. The following information is displayed for each module.

- **Type** displays the module's icon.
- **Slot** indicates the platform slot number where the module is inserted.
- **Module** indicates the name of the module.
- **Description** displays the description given to the module. Refer to the platform user guide for more information.
- **Serial Number** indicates the serial number of the module.
- **Remote Control** indicates if the remote control feature is enabled for this module. Refer to the *Controlling Modules Remotely* section from the platform user guide for more information.
- **Standalone** indicates if the standalone feature is possible for this module. Refer to the *Controlling Modules Remotely* section from platform platform user guide for more information.
- **Version** indicates the software version of the module application.

Applications for...

Note: *The application icon is only available if the selected module has its **Remote Control** enabled and is only displayed if the module is supported by the **Remote ToolBox** application.*

Click on the icon to start the application.

The application is automatically started when the same version of the application is installed on the local PC.

The application is downloaded from the platform and installed on the local PC when either the application is not installed or the versions are different. Once installed, the application is automatically started. While downloading the application, the **Cancel** button allows cancelling the download and the installation process.

Note: *Multiple versions of a module application may be installed on the same PC. Use the Windows - Control Panel - Add/Remove tool to remove non-required versions from the PC.*

Index

Available BB_Credit	172
Average	345
Average RX Rate	459
Average TX Rate	461
Avg RX Rate	487
Avg. Round Trip Time	609

B

B1	398, 411, 592
B2	398, 411, 594
B3	401, 411, 598
Background	295, 308
Background Traffic	304
Backplane	148, 153, 154
Backplane Clock	153
Back-to-Back	258, 503
Back-to-Back button	426
Bandwidth Usage	423
Base Station	130
Batch button	278, 314
Battery	326
battery	
safety	664
Battery/AC Icons	30
BBE	441, 444
BBER	442, 445
BDI	378, 381, 386
BEI	380, 382, 388
Bell	296
BER	350
BER Threshold	142, 157, 238, 489
BERT	139, 155
BERT Duration	329
BERT Threshold	329
BIAE	381, 386
Bidirectional	253
Binary	297
Binary/Hex	217
BIP-2	408
BIP-8	380, 382, 388
Bit Error	142, 156, 238, 350, 469, 489

Bit Error Count	469
Bit Error Rate	469
Bit Error Test	492
Bit-Oriented Message	556
Block	360, 365
BPV	375
BRIDGE	149, 150
Bridge Request	552
Broadcast	528
BSD	378
BSF	378
Buffer Delay	496, 507
Buffer to Buffer Flow Control	172
Buffer Usage	574
Bulk Read	544
Burst	319, 459
Burst Count	320
Burst Duty Cycle	320
Burst Frames	163
Burst Max Rate	284
Burst Sequence	163
Burst Single	413
Burst Size	285, 459
Burst Test	167
Burst Time	258
Burst/IR Frame Ratio	164
Bursts	258
Burt	163
Busy	264
B-VLAN	209

C

C/R	558
C&M	187, 472
C&M Channel	187
c1	435
C2	196, 599
cable	708
Cable Delay	624
Cable Delay Compensation (ns)	339
Cable Mode	185, 646

Cable Test.....	74, 145	cHEC-UNCORR	370
Calibration Failed	621	CID	181, 424, 582, 584
Cancelled.....	621	CIR.....	229, 265, 281, 285
Capture button	575	CIR or CIR+EIR Frames.....	163
Capture Source.....	571	CIR+EIR	229, 285
Capture Status	574	Circuit.....	560, 561
Carrier Ethernet OAM.....	72	Classification	226, 231
caution		cleaning	
of personal hazard.....	3	front panel.....	663
of product hazard.....	3	Cleaning Optical Connectors	664
CBS.....	167, 286	Client	117
CBS Test Time.....	164	Client Data.....	423
CC Function.....	271	Client Frequency.....	350, 360
C-CDI.....	396	Client Management.....	423
CCM	510, 534	Client Offset	553
CDF pFCS.....	181	Clock	148, 171, 351
certification information	x	Clock Accuracy	136, 477
C-FDI	396	Clock block	107
Cfg. Status	573	Clock Class.....	136, 477
CFP4.....	17, 20, 147	Clock Mode	136, 148, 154, 477, 644
CFP4 Control	542	Clock Out.....	153
CFP4 Control Pins.....	543	Clock Synchronization	148
CFP4 MDIO/I2C Access Interface.....	544	C-LOS.....	395
CFP4 Power Class	542	Cm CRC-8	373
CFP4 Reference Clock	542	CMF	370
CFP4 Status Pins	543	CMF pFCS	181
CFP4 TX Status	544	CnD CRC-5.....	373
CFP8.....	22, 147	Code.....	422
CFP8 Control	542	Code Word	472
CFP8 Control Pins.....	543	Codeword.....	556, 563, 564
CFP8 MDIO/I2C Access Interface.....	544	Collision.....	361
CFP8 Power Class	542	Command/Response	559
CFP8 Reference Clock	542	Committed	279
CFP8 Status Pins	543	Committed - Burst Test.....	459
CFP8 TX Status	544	Committed Steps.....	460
Channel.....	243, 295, 551, 564	Complete.....	572
Channel Assignment Status.....	242	Config TCM	306
Channel ID	240, 242	Config/Save	648
channel identifier	736	Configuration/Performance Results	493
Channels Monitored.....	457	Connect.....	133, 250, 638
cHEC.....	583	Connect button	762
cHEC-CORR.....	370	Connected	165, 252

Index

Connection.....	264
Connector ...	109, 121, 127, 128, 129, 149, 171, 201, 644
Continuity Check.....	271
Continuity Check (Peer MEP)	509
Continuous.....	273, 319, 620
Control.....	564
conventions, safety	3
Copy.....	279
Copy From Throughput.....	260
Copy RX	422, 526, 527
Copy Service.....	279
Copy Services button.....	279
Copy Stream button.....	314
Core Header	580
core header	733
Count	344, 622
Couple with Interface.....	204
Coupled.....	118
Coupled RX to TX	139, 155
CP-bit	354
CPRI.....	157, 158, 352, 377, 471, 472, 703
CPRI/OBSAI BERT	79
CRC	377
CRC-4	356
CRC-6	353
C-RDI.....	396
Critical Event.....	497
CSF.....	383, 534
cTE (ns).....	523
cTE Averaging Period (s).....	339
Cumulative Offset	619
Current.....	345, 484
Current Throughput	519
Customer Frame TX Rate.....	320
customer service.....	672
Cut Through.....	504
CV	375, 468

D

D1	593
D2	593
D3	593
D4 through D12	594
DAPI	334, 525, 526
DAPI ODU-TIM	335, 526
DAPI OTU-TIM.....	335, 526
DAPI TCM-TIM	335
Data Size	606
Date and Time	30
Date Stamp	430
DCI	368
Deactivate Threshold (Symbols).....	183
Decoupled	118
Default all OH	582, 604
Default Gateway.....	203, 215, 216, 221, 224
Default Mapping	547
Default OTN OH.....	585
Defaults.....	170
Defect.....	142, 239, 413, 437, 470
Del Ch.....	243
Delay	217, 606, 622
Delay (ms)	454
Delay 1,2	625
Delay Measurement.....	478
Delay Mode	133
Delay Req IPDV	478
Delay Skew	480
Delay Skew Threshold.....	146
Delay T14.....	624
Delay-Request.....	134
Delete All	243
Delete Step.....	170
Delta.....	181
Destination	172
Destination B-MAC Address.....	209
Destination EoE MAC Address	207
Destination Flooding	211
Destination IP Address.....	213, 605
Destination MAC Address.....	162, 210, 532

FEC-CORR-BIT	388	Frame Loss....	232, 273, 321, 322, 391, 455, 463, 464, 487, 494, 503
FEC-CORR-CW	388, 392	Frame Loss / Out-of-Sequence	
FEC-CORR-SYMB	388	Stream	464
FEC-LOA	392	Frame Loss button	426
FEC-LOAML	392	Frame Loss Configuration	259
FEC-STRESS-CW	389	Frame Loss Rate	286, 519
FEC-SYMB	365, 392	Frame Loss Ratio	512
FEC-UNCOR-CW	363	Frame Loss Threshold	269
FEC-UNCORR	389	Frame Number	575
FEC-UNCORR-CW	389, 392	Frame Rate	436, 490, 528, 570, 642
Fibre Channel	172, 366	Frame Size	159, 161, 230, 254, 275, 278, 282, 313, 317, 426, 529
Field Match	573	Frame Sync	471
File	762	Frame Type	229, 423, 528
Filter	569	Framed	111
Mask	570	Framed L2	129
Operator	570	Framed Layer 1	122
Value	569	Framed Layer 2	122
Filter Configuration	568	frame-mapped GFP	729
Filter x	571	Framing	111, 122, 129, 132, 150, 151, 278, 294, 313
Filters	567	Framing Bit	353
Fixed	229, 317	Freq. Offset	419
Fixed Structure	305	Frequency	150, 152, 171, 175, 176, 195, 292, 374, 473, 554
Flood Range	211	Frequency Offset Analysis	555
Flow Control	185, 645	Frequency/Offset	515
Traffic	531	front panel, cleaning	663
Flow Direction	253	FSD	378
Flow Label	217	FSF	379
FLR	232, 494	FTFL	178, 587
Force Release	301	FTFL/PT	421
Force TX Idel	189	Function	273
Foreground Signal Label	590	Functions	33
Format	336, 337		
Frame	472		
Frame Clock Burst Generation	189		
Frame Count ...	276, 320, 436, 490, 528, 570, 574, 642		
Frame Count - RX	531		
Frame Delay	273, 454, 512		
Frame Delay Threshold	269		
Frame Distribution	253		
Frame Format	206, 220		

G

G.709 OTN	710
G.742 Bit 12	631
G.751 Bit 12	630, 631
G.751 Bit 14, 15, 16	630, 631

Index

- G.8113.1 267
 - G1 600
 - GAL 272
 - GCC BERT 577
 - GCC0 586
 - GCC1 589
 - GCC2 589
 - Generate & Save 576
 - Generated 196, 336
 - Generated Message 332
 - Generated Messages 556, 560, 563
 - Generated QL 190, 324, 450
 - Generic Framing Procedure 727
 - GFP 368, 727
 - GFP frame structure 731
 - GFP mapping 729
 - GFP-10B_ERR 372
 - GFP-cHEC-CORR 370
 - GFP-cHEC-UNCORR 370
 - GFP-DCI 368
 - GFP-eHEC-CORR 371
 - GFP-eHEC-UNCORR 371
 - GFP-EXM 368
 - GFP-F 181, 423
 - GFP-F/GFP-T 580
 - GFP-FDI 369
 - GFP-LFD 368
 - GFP-LOCCS 369
 - GFP-LOCS 369
 - GFP-pFCS 372
 - GFP-RDI 369
 - GFP-Reserved CMF 370
 - GFP-SB-CORR 371
 - GFP-SB-CORR (Post) 371
 - GFP-SB-CORR (Pre) 371
 - GFP-SB-UNCORR 372
 - GFP-T 181
 - GFP-tHEC-CORR 370
 - GFP-tHEC-UNCORR 371
 - GFP-UPM 368
 - GFP-UserDefined CMF 370
 - Global
 - EtherSAM 165
 - RFC 2544 252, 253
 - Services 277
 - Streams 313
 - Global alarm 32
 - Global Copy RX 422, 526
 - Global indicator 31
 - Global IPv6 Address 214, 223
 - Global Options 168, 253, 279, 314
 - Global Pass/Fail Verdict 321
 - Global Test Duration Estimate 167
 - Global Thresholds Type 321
 - Global Verdict 32
 - GM Info 135, 476
 - GM IP Address 133
 - GMP 373, 579
 - Granted Power Class 483
 - Granularity 259
 - Graph
 - RFC 2544 426
 - Traffic 533
 - GTE 296
- H**
- H1 593
 - H2 593
 - H3 593
 - H4 600
 - H4-LOM 399
 - HDLC 187
 - Header Layer 572
 - Help 762
 - Help button 34
 - Hi-BER 359
 - Hi-BER1027B 405
 - Hi-SER 362
 - HOP Limit TTL 217
 - Host Name 762
 - HP-PLM 400
 - HP-PLM/HP-UNEQ 427

HP-RDI	400	Injects	556
HP-REI	401	inserting a module	11
HPTC-IAIS	402	Inserting and Removing Transceiver Adaptor (TA)	12
HPTC-IEC	404	Interface	182, 200, 245, 329, 374, 501, 571
HPTC-LTC	402	Interface block	106
HPTC-ODI	402	Interface ID Coupled	214, 223
HPTC-OEI	404	Interface Type	149, 151
HPTC-RDI	403	Interface/Rate ...	108, 120, 126, 128, 129, 200, 644
HPTC-REI	404	Internal	148, 154, 644
HPTC-TIM	403, 527	Internal 1/160	152
HPTC-UNEQ	308, 402	Internal 1/40	152
HPTC-VIOL	403	Internal 1/8	152
HP-TIM	337, 399, 527	Interval (CW)	183
HP-UNEQ	399	Inv. Flag	405
Hyperframe	472	Inv. Mapping	362
I			
I/O Interface Quick Check	491	Inv. Marker	365, 385
I2C - Bulk Read	544	Invalid	424, 425
I2C Address	544	Invalid DMR	454
I2C Data	544	Invalid LBR	452
I2C End Address	544	Invalid LMR	455
I2C Start Address	544	Invalid LTR	627
IAE	381, 386	Invalid Payload	453
ID	326, 432	Invalid SLR	456
Ideal L4	496, 506	Invalid TST	453
identification label	668	Inv-CW-Marker	392
Identity	135, 476	Invert	141, 156, 237
Idle	297, 354, 360, 423, 558	iOptics	42
Idle/Grp (K_MG)	190	IP	213, 251, 311, 642
IFDV	232, 494	IP Address	203, 221, 270
Import/Export tab	656	IP Checksum	376
Increment/Decrement Size	553	IP TOS/DS	133, 217, 327, 606
Information	451	IP Version	203, 205, 221
Information Count	515	IP/UDP/TCP	376
Information Rate	285	IPDV	447
Informational	459, 461	IPDV Threshold	137
Initial Window Size	328	IPv4	213, 221
Inject	489, 532, 556, 564, 611	IPv6	213, 222
Inject button	413, 416	IPv6 Destination Address	215
Injection	560	iSAM	43

Index

I-TAG 209
ITU G.8275.1 132

J

J0 592
J0 Trace 191, 537
J1 598
J1 Trace 191, 537
J2 603
Jabber 360
jammed bit 8 296
JC 586, 588, 589
JC1 586
JC2 588
JC3 589
JC4 586
JC5 587
JC6 589
Jitter 232, 322, 462, 464, 494, 519
 Streams 464
Job Information 648

K

K1 550, 594
K2 551, 594
K3 601
K4 604
Keyboard usage 38

L

L Deg SER Det 362
L Deg SER Rcd 362
L1 Reset 472
L2 226
L3/L4 226
Label 272, 537
Label 1 272, 436
Label 2 272, 436
label, identification 668
Labels 196, 427

Lane 414
Lanes Mapping & Skew 545
Lanes with Disruption 438, 457
LASER 25
Laser 192, 287
Laser OFF at Start-Up 193, 202, 247, 288
Laser On 667
Laser ON/OFF 193, 288, 549
Last 345
Last Change 448, 478, 515
Last Disruption 457
Last Link Trace Status 626
Last QL Message 515
Last QL Received 448, 450, 478
Late Coll. 361
Latency 232, 322, 462, 465, 494, 503, 519
 Streams 465
Latency button 426
Latency Configuration 260
Latency Measurement Mode 168
Latency Tag 159
Latency Tag Insertion 159
Layer 226, 413, 504
LBM 534, 535, 643
LBO 151, 289
LBR 535, 643
LBR Timeout 452
LCD-P 410
LCK 379, 395, 534
Lease Duration 134
LED 25
 Blue 25
Legend TX/RX 590
Length 480, 482
Length Threshold 146
Length Unit 145
LFD 368
Line 397
Line Coding 150, 151, 290
Line Utilization 436, 490, 528, 570, 642
LINK 155, 182, 200
Link Activity 558, 561, 565

Link Capacity	314	Longest Disruption	438, 457
Link Down	352, 359, 366, 377	LOOMFI	383
Link Events	429	Loop Down	637
Link Fault	498	Loop UP	637
Link OAM	198, 497	Loopback	273, 298, 311, 452, 565, 643
Link Trace	626	Loopback Commands	564, 566
Link TX/RX Scrolling	590	Loopback Mode	125, 642
LINK/RX	25	Loop-Down	250, 299, 301
Link-Local IPv6 Address	213, 222	Loop-Up	250, 299, 301
LMM	534, 535, 643	LOP-P	399, 410
LMR	535, 643	LOPPS-L	168, 351
Loaded Voltage	484	LOPPS-R	168, 351
LOAML	364	LOP-V	406
LOAML1027B	405	LOR	385
LOBL1027B	405	LOS	374, 468
LOC	153, 351	Loss Announce	390
LOC Lane	374	Loss Continuity	393
Local	325	Loss Sync	390
Local block	101	LP-ERDI-CD	408
Local Clock	185, 646	LP-ERDI-PD	408
Local Fault Det	359	LP-ERDI-SD	407
Local Fault Detected	366	LP-PLM	197, 407
Local Fault Rcd	359	LP-PLM/LP-UNEQ	427
Local Fault Received	366	LP-RDI	406
Local Module Identification	638	LP-REI	408
Local Parameters	270	LP-RFI	406
Local to Remote	253	LPTC-	404
LOCCS	369	LPTC-IAIS	402
LOCS	369	LPTC-LTC	402
LOF... 352, 355, 356, 357, 358, 377, 385, 387, 409		LPTC-ODI	402
LOFLOM	379	LPTC-OEI	404
LOF-S	397	LPTC-RDI	403
Logger	432	LPTC-TIM	337, 403, 527
Logger Full ... 467, 474, 488, 497, 499, 502, 506, 508, 513, 516, 519, 521		LPTC-UNEQ	308, 402
Logical Lane	545, 546	LPTC-VIOL	403
Login	173	LP-TIM	337, 407, 527
Logo	649	LP-UNEQ	197, 407
LOL	385	LSP	272
LOM	387	LTC	381
LOMF	355	LTM	534, 535, 643
		LTR	535, 643
		LTR Timeout	627

Index

M

M0	595, 597
M1	595, 597
MA Name	270
MAC	251
MAC Address	220, 270, 271
MAC/IP/UDP	204
MAID	270
maintenance	
front panel	663
general information	663
Manual	185, 414, 489, 573
Manual Loopback Status	501
Manual Mapping	547
Manual Skew	548
Mapping Efficiency	423
Margin	260
Mask	338, 417
Filter	570
Matching & Swapping	311
Max Absolute TE (ns)	522
Max cTE (ns)	523
Max dTEH pk-pk (ns)	522
Max Hop Count	607
Max Jitter	286
Max Latency	286, 487
Max Rate	414, 489
Max Round Trip Time	609
Max Round-Trip Latency	286
Max RX Power	192, 288
Max RX Rate	487
Max TE (ns)	522
Max TIE (ns)	523
Max TIE pk-pk (ns)	523
Max TX Rate	319
Max. (-/+) Offset	515
Max. Jitter	487
Max. Negative Offset	176, 293, 554
Max. Offset	195
Max. Positive Offset	176, 293, 555
Max. Rate	256, 259
Maximum	345
Maximum OAMPDU Size	428
Maximum test duration	338
Maximum Window Size	328
MD Level	271
MDIO - Bulk Read	544
MDIO Address	544
MDIO Data	544
MDIO End Address	544
MDIO Start Address	544
Measure Delay button	621
Mechanism	133
MEF	267
MEG ID	270
MEG Level	271, 415
MEP ID	271
Message Group	472
Message Rate	134
Message Type	434
Messages	434
Metrics	462
MFAS	389, 585
Mid-Trigger	574
Min Round Trip Time	609
Min RX Power	192, 288
Min TE (ns)	522
Min TIE (ns)	523
Minimum	345
Minimum RTT	495, 506
Minimum Window Size	328
Mismatch	181
Mismatch '0'	351
Mismatch '1'	351
Mismerge	393
Mode	132, 171, 243, 311, 413, 563, 620
Modify DS0	296
Modify E0	296
Modify Frame Structure	205
Modify Loop Codes	299, 301
Modify Structure	104
Ethernet Test Applications	120
Packet Sync Test Applications	126, 128

Path/Mapping	
DSn/PDH BERT.....	54
OTN BERT.....	44, 45
OTN-SONET/SDH BERT	48
SONET/SDH - DSn/PDH BERT	56
SONET/SDH BERT	51
Pattern	139, 155, 237, 298
Pattern Error.....	156, 350, 469
Pattern Error Count	469
Pattern Error Rate.....	469
Pattern Loss.....	350
Pattern Sync.....	141
Pause Frames.....	531
Payload	219, 276
Payload Content.....	297
payload FCS.....	737
payload FCS indicator.....	734
payload header	733
payload information field.....	737
Payload Type	179, 240, 422
payload type identifier	733
PBB-TE	207, 209, 572
P-bit	354
PCS BIP-8.....	365
PCS BIP-8 Mask.....	365
PCS Lane	545, 546
PCS Lanes	364
PD	232
PDI-P	400
Peer MEP Parameters.....	271
Peer Target RP3 Address.....	190
Per Direction Configuration.....	168
Percentage Lost.....	609
Performance Criteria	232, 286
Performance Information	562
Performance Monitoring	439
Performance Report Message.....	560
Performance Test	227
Period.....	272, 274, 320, 414, 415
pFCS.....	372
PFI	424, 580, 583
PHY Type	121, 200
Physical clock port.....	106
Physical Interface	
Electrical	289
Optical	287
Physical interface port	105
Ping & Trace Route	605
Ping button	606
Pins.....	480
PLI	583
PLM	384
PLM-P	400, 410
PLM-P/UNEQ-P	411, 427
PLM-V	197, 407
PLM-V/UNEQ-V	427
PM.....	588
PM & TCM	587
PM TTI Traces.....	332, 525
PoE	145, 483
PoE Loaded Voltage Thresholds.....	146
Point To Point.....	173
Pointer Adjustment.....	610
Pointer Value.....	610, 619
Port #1 to Port #2	253
Port #2 to Port #1	253
Port 1	120, 129
Port 2	120, 129
Port A	17
Port A1	17
Port A2	17
Port Availability on the Module	20
Port B	17
Port B1	17
Port B2	17
Port Status.....	174
POS Violation.....	405
Positive	195
Post-Trigger	574
Power	484
Power Class	146
Power Consumption	492
Power Presence	483
Power Range	193, 288, 645

REF OUT	17, 18, 20, 22	Reserved PTI.....	424
Reference	171	Reset.....	622
Reference Signal.....	391	Reset button.....	652
REF-FAULT	391	Reset Skew	548
Refill	163	Resolve MAC.....	270
Refill Delay	163	Resolve MAC Address	210, 216, 251
Refill Delay Ratio	164	Responder	535
Refresh	419	Restore 1588 PTP Defaults.....	138, 340
REI-L.....	398, 412	Restore Cable Test Defaults	146
REI-L Computation Method.....	308	Restore Carrier Ethernet OAM Defaults	276
REI-P.....	401, 412	Restore CPRI/OBSAI Defaults	158
REI-V	408	Restore Default.....	283, 325
Relative	432	Restore Default at Start-Up.....	325
Release	301	Restore EtherBERT Defaults	155
Reliability.....	218	Restore EtherSAM Defaults.....	168
Re-Login.....	173	Restore Multi-Channel OTN Defaults	244
Remote block	101	Restore OTN BERT Defaults	155
Remote Control.....	325	Restore RFC 2544 Defaults.....	254
Remote Fault.....	359, 366	Restore RFC 6349 Defaults.....	266
Remote Fault Emulation	184	Restore SyncE Defaults	324
Remote IP Address	265, 327	Restore TCP Throughput Defaults	328
Remote Loopback.....	429	Restore Test Application Defaults	144
Remote Modules Discovery	636	Results	33, 607
Remote Radio Head.....	130	Re-transmitted Frames.....	517
Remote to Local	253	return merchandise authorization (RMA) ..	672
Remote ToolBox	759	Revision	428
Installation.....	761	RFC 2544	61
Starting and using.....	762	Global	253
Remote unit in DTS Mode	486, 502, 506	RFC 6349	63, 264
Remote unit in use and locked for DTS.....	485, 502, 506	RFC 6349 Results	493
Remove Offset.....	419	RFC 6349 Test on Service 1	227
removing a module	11	RFI-V	406
Renewal Interval.....	134	R-LOF	352
Replied Details.....	609	R-LOS.....	352
Report Content.....	561	Round Trip Delay	623, 624, 625
Request	550	Round Trip Latency.....	518
Requesting MEP ID TLV	274	Round Trip Time	623
RES.....	586, 587, 589, 590	Round-Trip Latency.....	490
Reserved Bit.....	218	Round-Trip Latency Threshold	159, 490
Reserved CMF.....	370	RP3 Address.....	190
Reserved PLI	424	RP3 Address Mismatch	377
		RP3 Peer Target Address.....	472

Index

RS 397
RS (J0) 527
RS-FAS 398
RS-FEC 182, 201, 392
RS-FEC (RX Only) 183
RS-LOF 397
RS-OOF 397
RS-TIM 337, 397, 527
RTD 620, 623
RTT 494, 623, 625
Running 621
Runt 361
RX 240
RX button 591
RX CCM 509
RX Cm 579
RX CnD 579
RX DMR 454
RX Frame Clock Burst Details 435
RX Frame Count 463
RX Frames 503
RX Frequency 176, 195, 292, 473, 554
RX LBR 452
RX Line Utilization 512
RX LMR 455
RX LTR 627
RX Mismatch 424
RX OH Byte Details 590
RX Pattern 140, 141
RX Pointer Adjustment 619
RX Power 192, 287, 644
RX Power Range 329
RX Rate 462, 466, 494
RX Seed 189
RX Signaling 629
RX SLR 456
RX Structure Match 241
RX Termination 290
RX TST 453

S

S. & F. 504
S1 307, 594
Sa4 630, 631
Sa5 630, 631
Sa6 630, 631
Sa7 630, 631
Sa8 630, 631
safety
 battery 664
 caution 3
 conventions 3
 warning 3
Sampling Rate 338, 524
SAPI 333, 525
SAPI ODU-TIM 335, 526
SAPI OTU-TIM 335, 526
SAPI TCM-TIM 335
Save TE Data 420
Save TIE Data 420
Save to CSV 544
Save/Load button 653
Save/Load tab 654
SB-CORR 371
SB-CORR (Post) 371
SB-CORR (Pre) 371
SB-UNCORR 372
Scrambler 302
Scrambling 186, 189
SDI 352
SDT Threshold 144, 158, 239, 457, 471
Secondary Port 121
Seconds 344
Seconds per Service 166
Section 272, 397
Section (J0) 527
SEF 397, 409
SEP 443
SEPI 443
SEQ Violation 405
Sequence 186, 471

Serial Number	326	signal rates	726, 745
Server Address	762	Signaling Bits	628
Service	280, 486, 494, 495	Signaling Mode	628
service and repairs	672	Single	620
service centers	673	Skew	545
Service Configuration		Skew Alarm Threshold	364, 549
Ramp	460	Skew Threshold	329
Service Configuration Test	166, 227, 486	SLA button	278
Service Configuration Test button	486	SLA Parameters	285, 462
Service Configuration Test Status	485, 493	SLA Verified	459, 460
Service Disruption	142, 238, 437, 457, 470	SLM	534, 535, 643
Service Duration	134	SLR	535, 643
Service Name	164, 277	SM	585
Service Name and Selection	459, 460, 462	SM TTI Traces	332, 525
Service No	164	Smart Loopback	68, 311
Service Performance	462	SMB	25
Service Performance Test	167, 486	S-OAM	205, 212, 267, 393, 428, 452
Service Performance Test button	486	Traffic	534
Service Performance Test Status	485, 493	S-OAM Link Trace	626
Service Selection	204	S-OAM Responder	268, 312, 643
Services	228	Software options	34
SES	440, 443	SONET/SDH	591
SESR	442, 445	SONET/SDH - DSn/PDH BERT	55
Set All	297	SONET/SDH BERT	50
Setup	33	SONET/SDH Multiplexing	116
SFN	435	Sort By	432
SFP	147	Source	152, 172
SFP+	17, 18, 20, 147	Source B-MAC Address	209
SFP28	22, 147	Source EoE MAC Address	207
SFP56	22	Source Flooding	211
Shaping	319	Source IP Address	213, 605
Shaping button	320	Source IP Multiplier	216
shipping to EXFO	672	Source MAC Address	162, 210
Si0	630, 631	Source Node ID	551
Si1	630, 631	Source Port	219
SID	209	Source RP3 Address	190
Signal	171, 287	Spare	582, 584, 736
Signal Auto-Detect	131	Spare Bits	630
Signal Configuration	293	Special VID values	758
DSn/PDH	294	Specific IP	636
OTN	302	specifications, product	2, 675
SONET/SDH	307	Speed	185, 202, 645

Index

- Start button 657
- Start Time.... 330, 467, 474, 477, 479, 485, 488, 491, 493, 497, 499, 501, 502, 505, 508, 513, 516, 519, 521, 641
- Stateless Auto 213, 214, 222, 223
- Static 213, 215, 222, 224
- Status.... 467, 499, 501, 505, 509, 511, 608, 621, 641
- Status Bar 28
 - Alarm/Error Injection 30
 - Busy 30
 - Clock synchronization 30
 - Connected 29
 - Disconnected 29
 - ESMC 28, 29
 - Interface/Signal 28
 - Laser 29
 - LINK 28
 - Loopback 30
 - Loopback mode 30
 - OH 30
 - P1, P2 28
 - P1, P2, P3, P4..... 28
 - Pattern 29
 - Power level 29
 - Remote PC connection..... 30
 - Test icon 28
 - TX/RX, TX, RX..... 28
- Step..... 426, 503, 504, 610
- Step Size 292
- Step Size 175, 194
- Step Time 169, 320
- STM-1 Channel..... 591
- Stop button..... 657
- Stop Time 331
- storage requirements 663
- Stream 315, 464, 465, 466, 520, 605
- Stream Name 313
- Stream Selection 204
- Stream Selection and Activation..... 315
- STS Path (C2)..... 196, 427
- STS Path (J1)..... 527
- STS Path (N1)..... 337, 527
- STS-1 Timeslot 591
- STS-x..... 399
- Subchannel..... 187
- Subnet..... 636
- Subnet Mask..... 203, 216, 221
- Subtest Duration 167
- Subtests..... 166, 253
 - RFC 2544 255
- Subtests EtherSAM
 - Service Configuration Test 227
- Summary 467, 499
 - 1588 PTP..... 474
 - Cable Test 479
 - EtherSAM..... 485
 - FC BERT 488
 - iSAM 491, 493
 - MPLS-TP OAM 497, 508
 - NI/CSU Emulation..... 501
 - RFC 2544 502
 - RFC 6349 505
 - S-OAM 497, 508
 - SyncE 513, 521
 - TCP Throughput..... 516
 - Traffic Gen & Mon 519
- Superblock 425
- Sweep..... 318
- Switching Mode 550
- Symbol 360, 367
- symbols, safety..... 3
- Sync..... 134, 189, 472
- Sync IPDV 478
- SyncE..... 76, 323, 401
- Synchronization Status Message (S1) 307
- Synthetic Loss 273, 456
- Synthetic Loss Ratio..... 512
- Synthetic Loss Threshold 269
- System..... 95, 325

T

T0.....	562	TC-TIM.....	337
T0-1.....	562	TC-TIM-P.....	403, 527
T0-2.....	562	TC-TIM-V.....	403, 527
T0-3.....	562	TC-UNEQ-P.....	308, 402
Target.....	636	TC-UNEQ-V.....	308, 402
Target RP3 Address.....	190	TC-VIOL-P.....	403
TC.....	272	TC-VIOL-V.....	403
TC-IAIS-P.....	402	TDEV.....	418
TC-IAIS-V.....	402	TE (ns).....	522
TC-IEC-P.....	404	TE Scale.....	524
TC-LTC-P.....	402	technical specifications.....	2, 675
TC-LTC-V.....	402	technical support.....	668
TCM.....	303, 306, 308, 402, 720	Temp. Threshold.....	329
TCM Access Point Identifier.....	337	Temperature.....	492
TCM ACT.....	587	temperature for storage.....	663
TCM TTI Traces.....	332	TERM.....	149, 150
TCM1.....	588	Termination.....	149
TCM2.....	588	Test.....	273, 453
TCM3.....	588	Test Applications.....	41
TCM4.....	587	Test Block.....	106
TCM5.....	587	Test Configurator.....	95
TCM6.....	587	Ethernet Test Applications.....	102
TC-ODI-P.....	402	Fibre Channel Test Application.....	103
TC-ODI-V.....	402	Intelligent Apps.....	100
TC-OEI-P.....	404	Overview.....	100
TC-OEI-V.....	404	Packet Sync Test Applications.....	103
TCP.....	219	Transport Test Applications.....	102
TCP Checksum.....	376	Wireless Test Applications.....	103
TCP Connection Configuration.....	327	Test Control.....	33
TCP Connection Status.....	517	Test Equipment.....	325
TCP Efficiency.....	496, 506	Test Function.....	273
TCP Mode.....	327	Test ID.....	276
TCP Port.....	265, 327	Test Menu.....	33
TCP Throughput.....	71, 327, 518	Test Parameters.....	284
TCP Throughput Configuration.....	328	Test Pattern.....	276
TCP Throughput Threshold (% of ideal).....	507	Test Recovery.....	467, 474, 488, 497, 499, 502, 505, 508, 513, 516, 519, 521
TC-RDI-P.....	403	Test Sequence block.....	100
TC-RDI-V.....	403	Test Setup.....	41
TC-REI-P.....	404	Test Status.....	474, 479, 488, 495, 497, 508, 513, 516, 519, 521
TC-REI-V.....	404	Test Timer.....	33

Index

tHEC.....	583	Total Number of Bytes.....	572
tHEC-CORR.....	370	Total PTP Messages.....	478
tHEC-UNCORR.....	371	Total TX Rate.....	279, 281, 314, 321
Threshold.....	328, 430	Total TX/RX MPLS.....	436
Threshold (% of ideal).....	227, 266	Trace Route.....	607
Thresholds.....	183, 269, 464, 465, 466	Traces.....	537
Through.....	118	OTN.....	457, 525
Through Intrusive.....	119	SONET/SDH.....	336, 527
Through Mode.....	70	Traffic.....	490, 528
Throughput.....	217, 255, 321, 503	Traffic Class (TOS/DS).....	217
Streams.....	466	Traffic Ethernet.....	471
Throughput button.....	426	Traffic Gen & Mon.....	66
Throughput meter.....	517	Traffic Monitoring.....	534
Throughput Pass/Fail Verdict.....	328	Traffic Policing.....	284
Throughput Threshold.....	517	Traffic Scan.....	632
TIE (ns).....	523	Transceiver Adaptor Insertion Counter.....	326
TIE Scale.....	524	Transceiver Adaptor Parameters.....	326
TIM.....	379, 381, 387	Transcoding.....	405
Time.....	432, 562	Transmitted Frames.....	517
Time Error.....	419	Transparent.....	125, 641
Time Interval Error.....	419	Transparent (Pseudo-Physical).....	125, 641
Time Mode.....	432, 458	transparent-mapped GFP.....	729
Time Source.....	136, 477	Transport Layer.....	206, 423
Time Stamp.....	430, 458	transportation requirements.....	663, 668
Time Zone.....	325	Trial.....	503
Timeout.....	606, 607	Trial Duration.....	256, 259, 260
Timer.....	33, 95, 330	Trials.....	256, 258, 259, 260
Timeslot.....	308	Tributary Port.....	240, 306
TIM-P.....	337, 399, 527	Tributary Slot.....	243
TIM-S.....	337, 397, 527	Tributary Synchronization.....	154
TIM-V.....	337, 407, 527	Trigger Position.....	574
Title Bar.....	31	Trigger Type.....	573
TLV Type.....	276	Triggered Error.....	574
To the following Services.....	279	Triggered Frame - Details.....	575
Toffset.....	624	Truncated.....	572
Tone.....	297	Truncation Calculator.....	572
Topology.....	104, 118, 125, 130	TS16 AIS.....	355
TOS/DS.....	217, 266	TS16 Frame 0 Bit 5, 7, 8.....	630, 631
TOS/DS Config.....	217	TST.....	534
Total.....	424, 425	TST RX Rate.....	512
Total Burst Test Time.....	164		
Total Frame.....	531		

Index

V

V5	602
Val	503
Valid	425
Valid Event Count	561
Validations	257
Value	610
Filter	569
Variable Retrieval	429
Vendor Specific Information	429
Verdict	32
--	32
FAIL	32, 345
PASS	32, 345
Version 1	186
Version 2	186
VID	758
Video	316
Video Codec	281, 316
View File After Generation	576
VLAN	211, 313
VLAN (ID/Priority)	278
VLAN ID	162, 202, 207, 209, 211, 225
VLAN ID/Priority	202
VLAN Priority	758
VLAN Tag	206, 207, 225
Voice	316
Voice Codec	281, 316
VT	406
VT Path	310
VT Path (V5)	196, 427
VT Path (Z6)	337, 527

W

Wander	77
warranty	
certification	671
exclusions	671
general	669
liability	670
null and void	669

Wavelength	192, 287
Window	430
Window (KiB)	496, 506
Window Size	518
Window Size Target per Connection	265
Window Sweep	506, 536
Windows Size Unit	517
Wire Map	479
Wire Map Test Result	481
Wiring Standard	145
WIS	409, 537
WIS button	191
WIS Link Down	409
World Wide Name	172
Write	544

Y

Y.1731	267
--------------	-----

Z

Z0	592
Z1	594
Z2	597
Z3	601
Z4	601
Z5	601
Z6	603
Z7	604
Zero Code Suppression	296

CHINESE REGULATION ON RESTRICTION OF HAZARDOUS SUBSTANCES (RoHS)

中国关于有害物质限制的规定

NAMES AND CONTENTS OF THE TOXIC OR HAZARDOUS SUBSTANCES OR ELEMENTS
CONTAINED IN THIS EXFO PRODUCT

包含在本 EXFO 产品中的有毒有害物质或元素的名称及含量

Part Name 部件名称	Lead 铅 (Pb)	Mercury 汞 (Hg)	Cadmium 镉 (Cd)	Hexavalent Chromium 六价铬 (Cr(VI))	Polybrominated biphenyls 多溴联苯 (PBB)	Polybrominated diphenyl ethers 多溴二苯醚 (PBDE)
Enclosure 外壳	O	O	O	O	O	O
Electronic and electrical sub-assembly 电子和电气组件	X	O	X	O	X	X
Optical sub-assembly ^a 光学组件 ^a	X	O	O	O	O	O
Mechanical sub-assembly ^a 机械组件 ^a	O	O	O	O	O	O

Note:

注:

This table is prepared in accordance with the provisions of SJ/T 11364.

本表依据 SJ/T 11364 的规定编制。

O: Indicates that said hazardous substance contained in all of the homogeneous materials for this part is below the limit requirement of GB/T 26572.

O: 表示该有害物质在该部件所有均质材料中的含量均在 GB/T 26572 标准规定的限量要求以下。

X: indicates that said hazardous substance contained in at least one of the homogeneous materials used for this part is above the limit requirement of GB/T 26572. Due to the limitations in current technologies, parts with the "X" mark cannot eliminate hazardous substances.

X: 表示该有害物质至少在该部件的某一均质材料中的含量超出 GB/T 26572 标准规定的限量要求。



标记 "X" 的部件, 皆因全球技术发展水平限制而无法实现有害物质的替代。

a. If applicable.

如果适用。

MARKING REQUIREMENTS

标注要求

Product 产品	Environmental protection use period (years) 环境保护使用期限 (年)	Logo 标志
This EXFO product 本 EXFO 产品	10	
Battery ^a 电池	5	

a. If applicable.
如果适用。

P/N: 1073403

www.EXFO.com · info@exfo.com

CORPORATE HEADQUARTERS	400 Godin Avenue	Quebec (Quebec) G1M 2K2 CANADA Tel.: 1 418 683-0211 · Fax: 1 418 683-2170
EXFO AMERICA	3400 Waterview Parkway Suite 100	Richardson, TX 75080 USA Tel.: 1 972-761-9271 · Fax: 1 972-761-9067
EXFO EUROPE	Winchester House, School Lane	Chandlers Ford, Hampshire S053 4DG ENGLAND Tel.: +44 2380 246 800 · Fax: +44 2380 246 801
EXFO ASIA-PACIFIC	62 Ubi Road 1, #09-01/02 Oxley Bizhub 2	SINGAPORE 408734 Tel.: +65 6333 8241 · Fax: +65 6333 8242
EXFO CHINA	Beijing Global Trade Center, Tower C, Room 1207, 36 North Third Ring Road East, Dongcheng District	Beijing 100013 P. R. CHINA Tel.: +86 (10) 5825 7755 · Fax: +86 (10) 5825 7722
EXFO SERVICE ASSURANCE	250 Apollo Drive	Chelmsford MA, 01824 USA Tel.: 1 978 367-5600 · Fax: 1 978 367-5700
EXFO FINLAND	Elektroniikkatie 2	FI-90590 Oulu, FINLAND Tel.: +358 (0) 403 010 300 · Fax: +358 (0) 8 564 5203
TOLL-FREE	(USA and Canada)	1 800 663-3936

© 2018 EXFO Inc. All rights reserved.
Printed in Canada (2018-05)

