

Operating Manual

Network Analyzer

Protek A338
(4 Ports)

Version 2.0

TABLE OF CONTENTS

INTRODUCTION	9
SAFETY INSTRUCTIONS	10
1 GENERAL OVERVIEW	12
1.1 Description	12
1.2 Specifications	12
1.2.1 Basic Specifications	12
1.2.2 Supplemental Specifications.....	14
1.2.3 Measurement Capabilities	15
1.3 Principle of Operation	21
2 PREPARATION FOR USE	23
2.1 General Information	23
2.2 Front Panel	24
2.2.1 Power Switch.....	25
2.2.2 Test Ports.....	25
2.3 Rear Panel	26
2.3.1 Power Cable Receptacle.....	27
2.3.2 External Trigger Signal Input Connector	27
2.3.3 External Reference Frequency Input Connector	27
2.3.4 Internal Reference Frequency Output Connector	27
2.3.5 USB 2.0 High Speed	27
3 GETTING STARTED	28
3.1 Analyzer Preparation for Reflection Measurement.....	29
3.2 Analyzer Presetting	29
3.3 Stimulus Setting.....	29
3.4 IF Bandwidth Setting	30
3.5 Number of Traces, Measured Parameter and Display Format Setting	30
3.6 Trace Scale Setting	32
3.7 Analyzer Calibration for Reflection Coefficient Measurement	32
3.8 SWR and Reflection Coefficient Phase Analysis Using Markers	34
4 MEASUREMENT CONDITIONS SETTING	36
4.1 Screen Layout and Functions	36
4.1.1 Softkey Menu Bar	36
4.1.2 Menu Bar.....	38
4.1.3 Instrument Status Bar.....	38
4.2 Channel Window Layout and Functions	40
4.2.1 Channel Title Bar.....	41
4.2.2 Trace Status Field	42
4.2.3 Graph Area	45
4.2.4 Trace Layout in Channel Window	46
4.2.5 Markers	47

4.2.6	Channel Status Bar.....	48
4.3	Quick Channel Setting Using Mouse.....	51
4.3.1	Active Channel Selection	51
4.3.2	Active Trace Selection	52
4.3.3	Measured Data Setting	52
4.3.4	Display Format Setting.....	52
4.3.5	Trace Scale Setting.....	52
4.3.6	Reference Level Setting	53
4.3.7	Reference Level Position.....	53
4.3.8	Sweep Start Setting	53
4.3.9	Sweep Stop Setting	54
4.3.10	Sweep Center Setting	54
4.3.11	Sweep Span Setting.....	54
4.3.12	Marker Stimulus Value Setting.....	54
4.3.13	Switching between Start/Center and Stop/Span Modes	54
4.3.14	Start/Center Value Setting.....	54
4.3.15	Stop/Span Value Setting.....	55
4.3.16	Sweep Points Number Setting	55
4.3.17	Sweep Type Setting	55
4.3.18	IF Bandwidth Setting	55
4.3.19	Power Level / CW Frequency Setting.....	56
4.4	Channel and Trace Display Setting.....	57
4.4.1	Channel Window Allocating	57
4.4.2	Number of Traces Setting.....	58
4.4.3	Trace Allocating	58
4.4.4	Trace/Channel Activating.....	61
4.4.5	Active Trace/Channel Window Maximizing.....	61
4.5	Stimulus Setting.....	62
4.5.1	Sweep Type Setting	62
4.5.2	Sweep Span Setting.....	63
4.5.3	Sweep Points Setting.....	63
4.5.4	Stimulus Power Setting.....	63
4.5.5	Power Slope Feature	64
4.5.6	CW Frequency Setting	64
4.5.7	RF Out Function	65
4.5.8	Segment Table Editing	65
4.5.9	Measurement Delay	67
4.6	Trigger Setting.....	67
4.6.1	Point Feature for the External Trigger	70
4.6.2	External Trigger Polarity Setting	70
4.7	Measurement Parameters Setting.....	71
4.7.1	S-Parameters	71
4.7.2	S-Parameter Setting.....	72
4.7.3	Absolute Measurements	72
4.7.4	Absolute Measurement Setting	73
4.8	Format Setting	74
4.8.1	Rectangular Formats	74
4.8.2	Polar Format	75
4.8.3	Smith Chart Format.....	76
4.8.4	Data Format Setting	79
4.9	Scale Setting	81
4.9.1	Rectangular Scale.....	81

4.9.2	Rectangular Scale Setting.....	81
4.9.3	Circular Scale	82
4.9.4	Circular Scale Setting.....	82
4.9.5	Automatic Scaling.....	82
4.9.6	Reference Level Automatic Selection.....	83
4.9.7	Electrical Delay Setting.....	83
4.9.8	Phase Offset Setting	84
4.10	Measurement Optimizing.....	85
4.10.1	IF Bandwidth Setting	85
4.10.2	Averaging Setting	85
4.10.3	Smoothing Setting.....	86
4.11	Mixer Measurements.....	86
4.11.1	Mixer Measurement Methods.....	86
4.11.2	Frequency Offset Mode.....	88
4.11.3	Source/Receivers Frequency Offset Feature.....	90
4.11.4	Auxiliary Source	91
5	CALIBRATION AND CALIBRATION KIT.....	93
5.1	General Information.....	93
5.1.1	Measurement Errors.....	93
5.1.2	Systematic Errors.....	94
5.1.2.1	Directivity Error.....	94
5.1.2.2	Source Match Error.....	94
5.1.2.3	Load Match Error.....	94
5.1.2.4	Isolation Error.....	95
5.1.2.5	Reflection Tracking Error.....	95
5.1.2.6	Transmission Tracking Error.....	95
5.1.3	Error Modeling	96
5.1.3.1	One-Port Error Model	96
5.1.3.2	Two-Port Error Model.....	97
5.1.3.3	Three-Port Error Model.....	99
5.1.3.4	Four-Port Error Model.....	100
5.1.4	Analyzer Test Ports Defining	101
5.1.5	Calibration Steps.....	102
5.1.6	Calibration Methods.....	102
5.1.6.1	Normalization	104
5.1.6.2	Directivity Calibration (Optional).....	105
5.1.6.3	Isolation Calibration (Optional).....	105
5.1.6.4	Full One-Port Calibration	105
5.1.6.5	One-Path Two-Port Calibration	105
5.1.6.6	Full Two-Port Calibration	106
5.1.6.7	Full 3-Port Calibration	107
5.1.6.8	Full 4-Port Calibration	107
5.1.6.9	Simplified Full 3/4-Port Calibration	107
5.1.6.10	Sliding Load Calibration	108
5.1.6.11	Unknown Thru Calibration.....	108
5.1.6.12	TRL Calibration.....	109
5.1.6.13	Multiline TRL Calibration.....	112
5.1.7	Calibration Standards and Calibration Kits.....	115
5.1.7.1	Definitions and Classes of Calibration Standards.....	115
5.1.7.2	Types of Calibration Standards.....	115
5.1.7.3	Methods of Calibration Standard Defining.....	116
5.1.7.4	Calibration Standard Model.....	116
5.1.7.5	Data-Based Calibration Standards	118

5.1.7.6	Scope of Calibration Standard Definition.....	118
5.1.7.7	Classes of Calibration Standards.....	119
5.1.7.8	Subclasses of Calibration Standards	120
5.2	Calibration Procedures	121
5.2.1	Calibration Kit Selection	121
5.2.2	Reflection Normalization	122
5.2.3	Transmission Normalization.....	124
5.2.4	Full 1-Port Calibration	126
5.2.5	One-Path 2-Port Calibration	128
5.2.6	Full 2-Port Calibration	130
5.2.7	Full 3-Port Calibration	132
5.2.8	Full 4-Port Calibration	134
5.2.9	Unknown Thru Calibration.....	136
5.2.10	2-Port TRL Calibration	137
5.2.11	3-Port TRL Calibration	139
5.2.12	4-Port TRL Calibration	142
5.2.12.1	Multiline Option of TRL Calibration	145
5.2.13	Bandsplit Calibration Using Subclasses	146
5.2.14	Calibration Using Sliding Load	147
5.2.15	Error Correction Disabling	147
5.2.16	Error Correction Status.....	149
5.2.17	System Impedance Z_0	150
5.2.18	Port Extension.....	151
5.2.19	Automatic Port Extension.....	153
5.3	Calibration Kit Management	155
5.3.1	Table of Calibration Kits	156
5.3.1.1	Calibration Kit Selection for Editing.....	157
5.3.1.2	Calibration Kit Label and Description Editing	157
5.3.1.3	Predefined Calibration Kit Restoration	158
5.3.1.4	User-Defined Calibration Kit Deleting	158
5.3.1.5	Calibration Kit Saving to File	158
5.3.1.6	Calibration Kit Loading from File	158
5.3.2	Calibration Standard Definition	159
5.3.2.1	Standard Adding to Calibration Kit	160
5.3.2.2	Standard Deleting from Calibration Kit	160
5.3.2.3	Calibration Standard Editing	160
5.3.2.4	Calibration Standard Copy/Paste Function.....	161
5.3.2.5	Management of Sequence in Standard Table.....	162
5.3.3	Table of Calibration Standard S-Parameters	163
5.3.3.1	Line Adding to Table	164
5.3.3.2	Line Deleting from Table	164
5.3.3.3	Table Clearing	164
5.3.3.4	Table Format Selecting	164
5.3.3.5	Port Reversing	165
5.3.3.6	Data Loading from File	165
5.3.4	Calibration Standard Class Assignment	166
5.3.4.1	Standard Class Table Editing.....	167
5.3.4.2	Standard Deleting from Standard Class Table.....	167
5.3.4.3	Strict Class Assignment Function.....	168
5.3.4.4	Function of Group Assignment of Port Number	169
5.4	Power Calibration	170
5.4.1	Loss Compensation Table	170
5.4.2	Power Calibration Procedure.....	171
5.4.3	Power Correction Setting	171

5.4.4	Loss Compensation Table Editing	171
5.5	Receiver Calibration	172
5.5.1	Receiver Calibration Procedure	173
5.5.2	Receiver Correction Setting.....	175
5.6	Scalar Mixer Calibration	176
5.7	Vector Mixer Calibration	180
5.7.1	Vector Mixer Calibration Procedure	181
5.8	Automatic Calibration Module.....	183
5.8.1	Automatic Calibration Module Features	184
5.8.2	1-Port and 2-Port Automatic Calibration Procedure	185
5.8.3	3-Port Calibration with 2-Port ACM.....	186
5.8.4	4-Port Calibration with 2-Port ACM.....	188
5.8.5	Using External Thru Instead of Internal ACM Thru	190
5.8.6	User Characterization Procedure	190
5.8.7	Confidence Check Procedure	191
6	MEASUREMENT DATA ANALYSIS.....	193
6.1	Markers	193
6.1.1	Marker Adding.....	195
6.1.2	Marker Deleting	195
6.1.3	Marker Stimulus Value Setting.....	195
6.1.4	Marker Activating.....	196
6.1.5	Reference Marker Feature	197
6.1.6	Marker Properties.....	198
6.1.6.1	Marker Coupling Feature	198
6.1.6.2	Marker Table	199
6.1.6.3	Marker Value Indication Capacity	200
6.1.6.4	Multi Marker Data Display.....	200
6.1.6.5	Marker Data Arranging	201
6.1.6.6	Marker Data Alignment.....	201
6.1.6.7	Memory Trace Value Display.....	202
6.1.7	Marker Position Search Functions	202
6.1.7.1	Search for Maximum and Minimum.....	203
6.1.7.2	Search for Peak	203
6.1.7.3	Search for Target Level	205
6.1.7.4	Search Tracking	207
6.1.7.5	Search Range	208
6.1.8	Marker Math Functions	208
6.1.8.1	Trace Statistics.....	208
6.1.8.2	Bandwidth Search	210
6.1.8.3	Flatness.....	212
6.1.8.4	RF Filter Statistics.....	214
6.1.9	Marker Functions	215
6.2	Memory Trace Function.....	216
6.2.1	Saving Trace into Memory	217
6.2.2	Trace Display Setting	217
6.2.3	Mathematical Operations.....	218
6.3	Fixture Simulation	219
6.3.1	Port Reference Impedance Conversion	222
6.3.2	De-embedding.....	223
6.3.3	Embedding.....	225
6.3.4	4-Port Network Embedding/De-embedding.....	226

6.3.5	Measurement of Balanced Devices	229
6.3.5.1	Balance-Unbalance Conversion	229
6.3.5.2	Balanced Parameters	232
6.4	Time Domain Transformation	236
6.4.1	Time Domain Transformation Activating	237
6.4.2	Time Domain Transformation Span	237
6.4.3	Time Domain Transformation Type	238
6.4.4	Time Domain Transformation Window Shape Setting	238
6.4.5	Frequency Harmonic Grid Setting	239
6.5	Time Domain Gating	240
6.5.1	Time Domain Gate Activating	241
6.5.2	Time Domain Gate Span	241
6.5.3	Time Domain Gate Type	242
6.5.4	Time Domain Gate Shape Setting	242
6.6	S-Parameter Conversion	243
6.7	Limit Test	245
6.7.1	Limit Line Editing	246
6.7.2	Limit Test Enabling/Disabling	247
6.7.3	Limit Test Display Management	247
6.7.4	Limit Line Offset	248
6.8	Ripple Limit Test	249
6.8.1	Ripple Limit Editing	250
6.8.2	Ripple Limit Enabling/Disabling	252
6.8.3	Ripple Limit Test Display Management	252
7	ANALYZER DATA OUTPUT	253
7.1	Analyzer State	253
7.1.1	Analyzer State Saving	254
7.1.2	Analyzer State Recalling	255
7.2	Channel State	256
7.2.1	Channel State Saving	256
7.2.2	Channel State Recalling	256
7.3	Trace Data CSV File	257
7.3.1	CSV File Saving/Recalling	257
7.4	Save Data to Touchstone File	258
7.5	Touchstone File Recalling	261
8	SYSTEM SETTINGS	262
8.1	Analyzer Presetting	262
8.2	Graph Printing	262
8.3	Reference Frequency Oscillator Selection	263
8.4	System Correction Setting	264
8.5	Beeper Setting	265
8.6	User Interface Setting	265
8.7	Screen Update Setting	269
8.8	Power Meter Setting	270

8.9	Stimulus Frequency Adjustment.....	272
9	MAINTENANCE AND STORAGE	273
9.1	Maintenance Procedures	273
9.1.1	Instrument Cleaning.....	273
9.1.2	Factory Calibration	273
9.1.3	Performance Test	274
9.2	Storage Instructions	274
10	WARRANTY INFORMATION.....	275
	Appendix 1 — Default Settings Table	276

INTRODUCTION

This Operating Manual contains design, specifications, functional overview, and detailed operation procedures for the Network Analyzer, to ensure effective and safe use of its technical capabilities by the user.

Maintenance and operation of the Analyzer should be performed by qualified engineers with basic experience in operating of microwave circuits.

The following abbreviations are used in this Manual:

- PC – Personal Computer
- DUT – Device Under Test
- IF – Intermediate Frequency
- CW – Continuous Wave
- SWR – Standing Wave Ratio

SAFETY INSTRUCTIONS

Carefully read through the following safety instructions before putting the Analyzer into operation. Observe all the precautions and warnings provided in this Manual for all the phases of operation, service, and repair of the Analyzer.

The Analyzer should be used only by skilled and thoroughly trained personnel with the required skills and knowledge of safety precautions.

The Analyzer complies with INSTALLATION CATEGORY II as well as POLLUTION DEGREE 2 in IEC61010-1.

The Analyzer is MEASUREMENT CATEGORY I (CAT I). Do not use for CAT II, III, or IV.

The Analyzer is for INDOOR USE only.

The Analyzer has been tested as a stand-alone device and in combination with the accessories supplied by GS Instruments, in accordance with the requirements of the standards described in the Declaration of Conformity. If the Analyzer is integrated with another system, compliance with related regulations and safety requirements are to be confirmed by the builder of the system.

Never operate the Analyzer in an environment containing inflammable gasses or fumes.

Operators must not remove the cover or part of the housing. The Analyzer must not be repaired by the operator. Component replacement or internal adjustment must be performed by qualified maintenance personnel only.

Never operate the Analyzer if the power cable is damaged.

Never connect the test terminals to A/C power mains.

Electrostatic discharge can damage your Analyzer whether connected to or disconnected from the DUT. Static charge can build up on your body and damage sensitive internal components of both the Analyzer and the DUT. To avoid damage from electric discharge, observe the following:

- Always use a desktop anti-static mat under the DUT.
- Always wear a grounding wrist strap connected to the desktop anti-static mat via daisy-chained 1 M Ω resistor.
- Connect the post marked  on the body of the Analyzer to the body of the DUT before you start operation.

Observe all general safety precautions related to operation of electrically energized equipment.

The definitions of safety symbols used on the instrument or in the Manual are listed below.



Refer to the Manual if the instrument is marked with this symbol.



Alternating current.



Direct current.



On (Supply).



Off (Supply).



A chassis terminal; a connection to the instrument's chassis, which includes all exposed metal structure.

WARNING

This sign denotes a hazard. It calls attention to a procedure, practice, or condition that, if not correctly performed or adhered to, could result in injury or death to personnel.

CAUTION

This sign denotes a hazard. It calls attention to a procedure, practice, or condition that, if not correctly performed or adhered to, could result in damage to or destruction of part or all of the instrument.

Note

This sign denotes important information. It calls attention to a procedure, practice, or condition that is essential for the user to understand.

1 GENERAL OVERVIEW

1.1 Description

The A338 4 PORT Network Analyzer is designed for use in the process of development, adjustment and testing of various electronic devices in industrial and laboratory facilities, including operation as a component of an automated measurement system. The Analyzer is designed for operation with external PC, which is not supplied with the Analyzer.

1.2 Specifications

1.2.1 Basic Specifications

Table 1.1 Basic Specifications

1	2
Frequency range	100 kHz to 8.0 GHz
CW frequency accuracy	$\pm 5 \times 10^{-6}$
Harmonic distortion	25 dB
Non harmonic spurious	30 dB
Output power level - frequency range 300 kHz to 6.0 GHz - frequency range 6.0 GHz to 8.0 GHz	60 dBm to +10 dBm 60 dBm to +5 dBm
Output power level accuracy	± 1.0 dB
Magnitude transmission measurement accuracy ¹ , if $ S_{11} $ and $ S_{22} $ of the DUT are less than -32 dB, and $ S_{21} $ and $ S_{12} $ values are as follows: +5 dB to +15 dB -50 dB to +5 dB -70 dB to -50 dB -90 dB to -70 dB	0.2 dB 0.1 dB 0.2 dB 1.0 dB

¹ The specifications of the Analyzer apply over the temperature range of 23 °C \pm 5 °C (unless otherwise specified) after 40 minutes of warming-up, with less than 1 °C deviation from the full two-port calibration temperature, at output power of -5 dBm, and IF bandwidth 1 Hz.

Table 1.1 (continued)

1	2
Phase transmission measurement accuracy ¹ , if $ S_{11} $ and $ S_{22} $ of the DUT are less than -32 dB, and $ S_{21} $ and $ S_{12} $ values are as follows: +5 dB to +15 dB –50 dB to +5 dB –70 dB to –50 dB –90 dB to –70 dB	 2° 1° 2° 6°
Magnitude reflection measurement accuracy ¹ , if $ S_{11} $ and $ S_{22} $ values are as follows: –15 dB to 0 dB –25 dB to –15 dB –35 dB to –25 dB	 0.4 dB 1.0 dB 3.0 dB
Phase reflection measurement accuracy ¹ , if $ S_{11} $ and $ S_{22} $ values are as follows: –15 dB to 0 dB –25 dB to –15 dB –35 dB to –25 dB	 3° 6° 20°
Receiver noise floor (IF bandwidth 10 Hz)	125 dBm
Trace noise (IF bandwidth 3 kHz)	0.001 dB RMS
Uncorrected directivity	18 dB
Uncorrected source match	18 dB
Uncorrected load match	18 dB
AC mains voltage	100 to 240 VAC 50/60 Hz
Power consumption	40 W

¹ The specifications of the Analyzer apply over the temperature range of $23\text{ °C} \pm 5\text{ °C}$ (unless otherwise specified) after 40 minutes of warming-up, with less than 1 °C deviation from the full two-port calibration temperature, at output power of -5 dBm , and IF bandwidth 1 Hz.

Table 1.1 (continued)

Dimensions LxWxH	426 x 278 x 320 mm
Weight	10.25 kg
Operating conditions: – environmental temperature – humidity at 25 °C – atmospheric pressure	5 °C to 40 °C 90% 84 to 106.7 kPa

1.2.2 Supplemental Specifications

Source stability within operating temperature range $\pm 5 \times 10^{-6}$.

Frequency resolution 1 Hz.

Measurement time per test point 100 μ s.

Source to receiver port switchover time less than 10 ms.

Power level resolution 0.05 dB.

IF bandwidth settings from 1 Hz to 30 kHz with step of 1/1.5/2/3/5/7.

External reference frequency is 10 MHz, input level is 2 dBm \pm 2 dB, input impedance at «10 MHz» input is 50 Ω . Connector type is BNC female.

Output reference signal level is 3 dBm \pm 2 dB at 50 Ω impedance. «OUT 10 MHz» connector type is BNC female.

Connector for external trigger source is BNC female. TTL compatible inputs of 3 V to 5 V magnitude have more than 1 μ s pulse width. Input impedance at least 10 k Ω .

Effective directivity 45 dB.

Effective source match 40 dB.

Effective load match 45 dB.

Dependence of $|S_{21}|$ or $|S_{11}|$ parameter of 0 dB per 1 degree variation of environment temperature is less than 0.025 dB.

Warm-up time 40 min.

1.2.3 Measurement Capabilities

Measured parameters	S_{11} , S_{12} , S_{13} , S_{14} S_{21} , S_{22} , S_{23} , S_{24} S_{31} , S_{32} , S_{33} , S_{34} S_{41} , S_{42} , S_{43} , S_{44}
	Absolute power of the reference and received signals at the port.
Number of measurement channels	Up to 16 logical channels. Each logical channel is represented on the screen as an individual channel window. A logical channel is defined by such stimulus signal settings as frequency range, number of test points, power level, etc.
Data traces	Up to 16 data traces can be displayed in each channel window. A data trace represents one of the following parameters of the DUT: S-parameters, response in time domain, input power response.
Memory traces	Each of the 16 data traces can be saved into memory for further comparison with the current values.
Data display formats	Logarithmic magnitude, linear magnitude, phase, expanded phase, group delay, SWR, real part, imaginary part, Smith chart format and polar format.
Sweep setup features	
Sweep type	Linear frequency sweep, logarithmic frequency sweep, and segment frequency sweep, when the stimulus power is a fixed value; and linear power sweep when frequency is a fixed value.
Measured points per sweep	From 2 to 500001.
Segment sweep	A frequency sweep within several user-defined segments. Frequency range, number of sweep points, source power, and IF bandwidth should be set for each segment.
Power settings	Source power from -60 dBm to +10 dBm with resolution of 0.05 dB. In frequency sweep mode the power slope can be set to up to 2dB/GHz to compensate high frequency attenuation in cables.
Sweep trigger	Trigger modes: continuous, single, hold. Trigger sources: internal, manual, external, bus.

Trace display functions

Trace display	Data trace, memory trace, or simultaneous data and memory traces.
Trace math	Data trace modification by math operations: addition, subtraction, multiplication or division of measured complex values and memory data.
Autoscaling	Automatic selection of scale division and reference level value to have the trace most effectively displayed.
Electrical delay	Calibration plane compensation for delay in the test setup, or for electrical delay in a DUT during measurements of deviation from linear phase.
Phase offset	Phase offset in degrees.

Accuracy enhancement

Calibration	Calibration of a test setup (which includes the Analyzer, cables, and adapters) significantly increases the accuracy of measurements. Calibration allows for correction of the errors caused by imperfections in the measurement system: system directivity, source and load match, tracking and isolation.
Calibration methods	The following calibration methods of various sophistication and accuracy enhancement level are available: <ul style="list-style-type: none"> ▪ reflection and transmission normalization; ▪ full one-port calibration; ▪ one-path two-port calibration ▪ full 2/3/4-port calibration (SOLT); ▪ 2/3/4-port TRL calibration.
Reflection and transmission normalization	The simplest calibration method. It provides limited accuracy.
Full one-port calibration	Method of calibration performed for one-port reflection measurements. It ensures high accuracy.

One-path two-port calibration	Method of calibration performed for reflection and one-way transmission measurements, for example for measuring S_{11} and S_{21} only. It ensures high accuracy for reflection measurements, and reasonable accuracy for transmission measurements.
Full 2/3/4-port calibration	Method of calibration performed for full S-parameter matrix measurement of a 2/3/4-port DUT. Method also known as SOLT: Short, Open, Load, Thru. It ensures high accuracy.
2/3/4-port TRL calibration	Method of calibration performed for full S-parameter matrix measurement of a 2/3/4-port DUT. LRL and LRM types of this calibration are also supported. It ensures higher accuracy than a SOLT calibration.
Mechanical calibration kits	The user can select one of the predefined calibration kits of various manufacturers or define additional calibration kits.
Electronic calibration modules	GS Instruments' automatic calibration modules make the Analyzer calibration faster and easier than traditional mechanical calibration.
Sliding load calibration standard	The use of sliding load calibration standard allows significant increase in calibration accuracy at high frequencies compared to the fixed load calibration standard.
Unknown thru calibration standard	The use of an arbitrary reciprocal two-port device instead of a zero-length thru during a full 2/3/4-port calibration allows for calibration of the test setup for measurements of the non-insertable devices.
Defining of calibration standards	Different methods of calibration standard defining are available: <ul style="list-style-type: none"> ▪ standard defining by polynomial model ▪ standard defining by data (S-parameters).
Error correction interpolation	When the user changes such settings as start/stop frequencies and number of sweep points, compared to the settings of calibration, interpolation or extrapolation of the calibration coefficients will be applied.

Supplemental calibration methods

Power calibration	Method of calibration, which allows more stable maintaining of the power level setting at the DUT input. An external power meter should be connected to the USB port directly or via USB/GPIB adapter.
-------------------	--

Receiver calibration	Method of calibration, which calibrates the receiver gain at absolute signal power measurement.
----------------------	---

Marker functions

Data markers	Up to 16 markers for each trace. A marker indicates stimulus value and the measured value in a given point of the trace.
Reference marker	Enables indication of any marker values as relative to the reference marker.
Marker search	Search for max, min, peak, or target values on a trace.
Marker search additional features	User-definable search range. Functions of specific condition tracking or single operation search.
Setting parameters by markers	Setting of start, stop and center frequencies by the stimulus value of the marker and setting of reference level by the response value of the marker.
Marker math functions	Statistics, bandwidth, flatness, RF filter.
Statistics	Calculation and display of mean, standard deviation and peak-to-peak in a frequency range limited by two markers on a trace.
Bandwidth	Determines bandwidth between cutoff frequency points for an active marker or absolute maximum. The bandwidth value, center frequency, lower frequency, higher frequency, Q value, and insertion loss are displayed.
Flatness	Displays gain, slope, and flatness between two markers on a trace.
RF filter	Displays insertion loss and peak-to-peak ripple of the passband, and the maximum signal magnitude in the stopband. The passband and stopband are defined by two pairs of markers.

Data analysis

Port impedance conversion	The function converts S-parameters measured at 50 Ω port into the values which would be found if measured at a test port with arbitrary impedance.
De-embedding	The function allows mathematical exclusion of the effects of the fixture circuit connected between the calibration plane and the DUT. This circuit should be described by an S-parameter matrix in a Touchstone file.

Embedding	The function allows mathematical simulation of the DUT parameters after virtual integration of a fixture circuit between the calibration plane and the DUT. This circuit should be described by an S-parameter matrix in a Touchstone file.
S-parameter conversion	The function allows conversion of the measured S-parameters to the following parameters: reflection impedance and admittance, transmission impedance and admittance, and inverse S-parameters.
Time domain transformation	The function performs data transformation from frequency domain into response of the DUT to various stimulus types in time domain. Modeled stimulus types: bandpass, lowpass impulse, and lowpass step. Time domain span is set by the user arbitrarily from zero to maximum, which is determined by the frequency step. Various window shapes allow optimizing the tradeoff between resolution and level of spurious sidelobes.
Time domain gating	The function mathematically removes unwanted responses in time domain, allowing for obtaining frequency response without the influence of the fixture elements. The function applies a reverse transformation back to frequency domain from the user-defined span in time domain. Gating filter types: bandpass or notch. For better tradeoff between gate resolution and level of spurious sidelobes the following filter shapes are available: maximum, wide, normal and minimum.
Balanced-unbalanced conversion	The function converts unbalanced S-parameters to the balanced analogs by combining an arbitrary pair of ports into a single logical balanced port. Four configurations of DUTs with various configurations of balanced and unbalanced ports are supported.

Mixer / converter measurements

Scalar mixer / converter measurements	The scalar method allows measurement of scalar transmission S-parameters of mixers and other devices having different input and output frequencies. No external mixers or other devices are required. The scalar method employs port frequency offset when there is a difference between receiver frequency and source frequency.
Vector mixer / converter measurements	The vector method allows measuring of the mixer transmission S-parameter magnitude and phase. The method requires an external mixer and a LO common to both the external mixer and the mixer under test.
Scalar mixer / converter calibration	The most accurate method of calibration applied for measurements of mixers in frequency offset mode. The OPEN, SHORT, and LOAD calibration standards are used. An external power meter should be connected to the USB port directly or via USB/GPIB adapter.
Vector mixer /converter calibration	Method of calibration applied for vector mixer measurements. The OPEN, SHORT and LOAD calibration standards are used.
Automatic adjustment of frequency offset	The function performs automatic frequency offset adjustment when the scalar mixer / converter measurements are performed to compensate for LO frequency inaccuracies internal to the DUT.

Other features

Familiar graphical user interface	Graphical user interface based on Windows operating system ensures fast and easy Analyzer operation by the user.
Analyzer control	Using a personal computer.
Printout/saving of traces	The traces and data printout function has preview feature. Previewing, saving and printing can be performed using MS Word, Image Viewer for Windows, or the Analyzer Print Wizard.

Remote control

COM/DCOM	Remote control over COM/DCOM. COM automation runs the user program on Analyzer PC. DCOM automation runs the user program on a LAN networked PC.
----------	---

1.3 Principle of Operation

A block diagram of the Analyzer is represented in figure 1.1.

To perform S-parameter measurements, the Analyzer supplies the source signal of the assigned frequency from one of the ports to the DUT, then measures magnitude and phase of the signals transmitted through and reflected by the DUT, and finally compares these results to the magnitude and phase of the source signal.

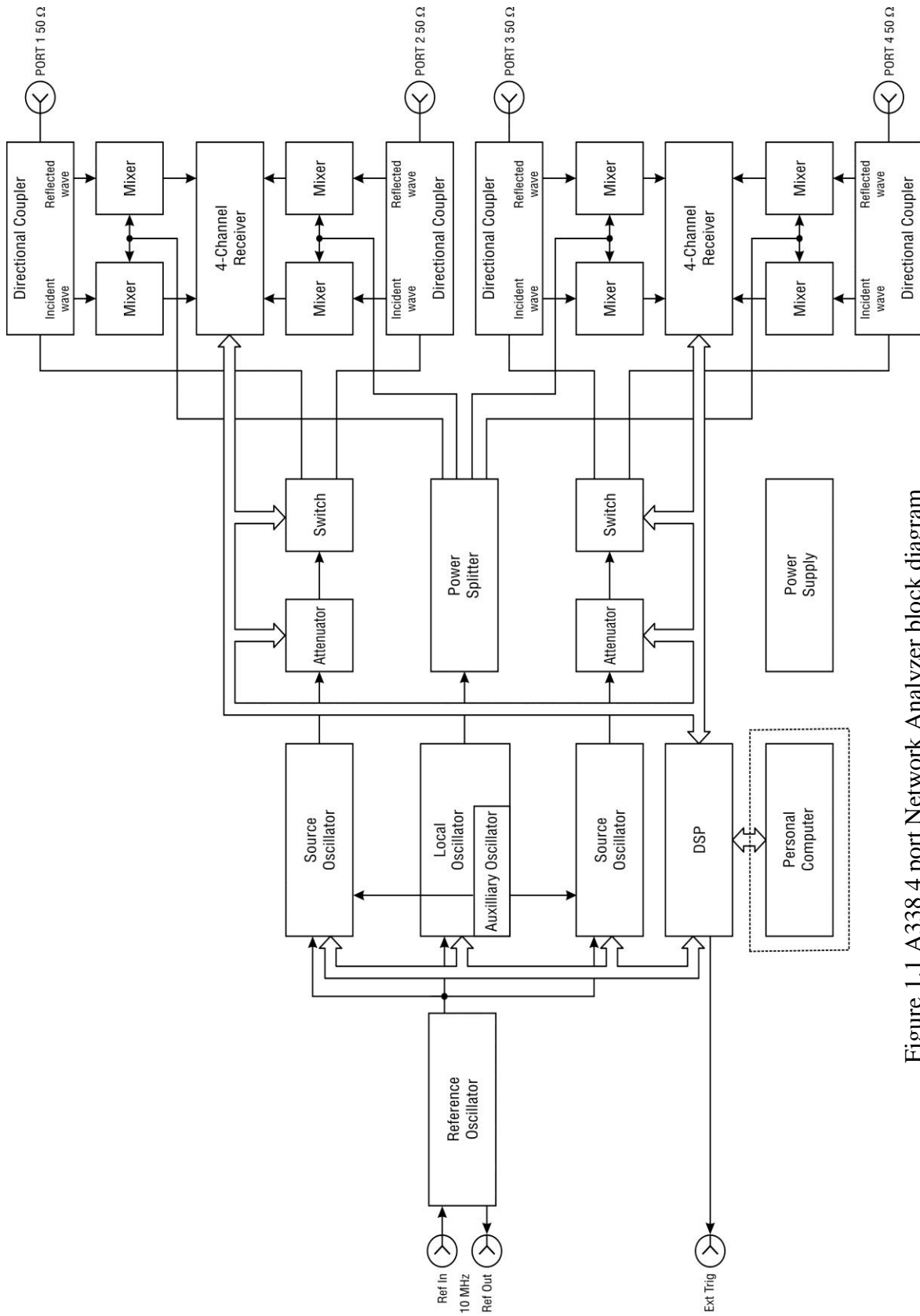

Figure 1.1 A338 4 port Network Analyzer block diagram

2 PREPARATION FOR USE

2.1 General Information

Unpack the Analyzer and other accessories. Connect the Analyzer to a 100 VAC to 240 VAC 50/60 Hz power source by means of the Power Cable supplied with the instrument.

Warm-up the Analyzer for 40 minutes after power-on.

Assemble the test setup using cables, connectors, fixtures, etc, which allow DUT connection to the Analyzer.

Perform calibration of the Analyzer. Calibration procedure is described in section 5.

2.2 Front Panel

The front view of A338 4 PORT is represented in figure 2.1. The front panel is equipped with the following parts:

- Power switch;
- Test ports.

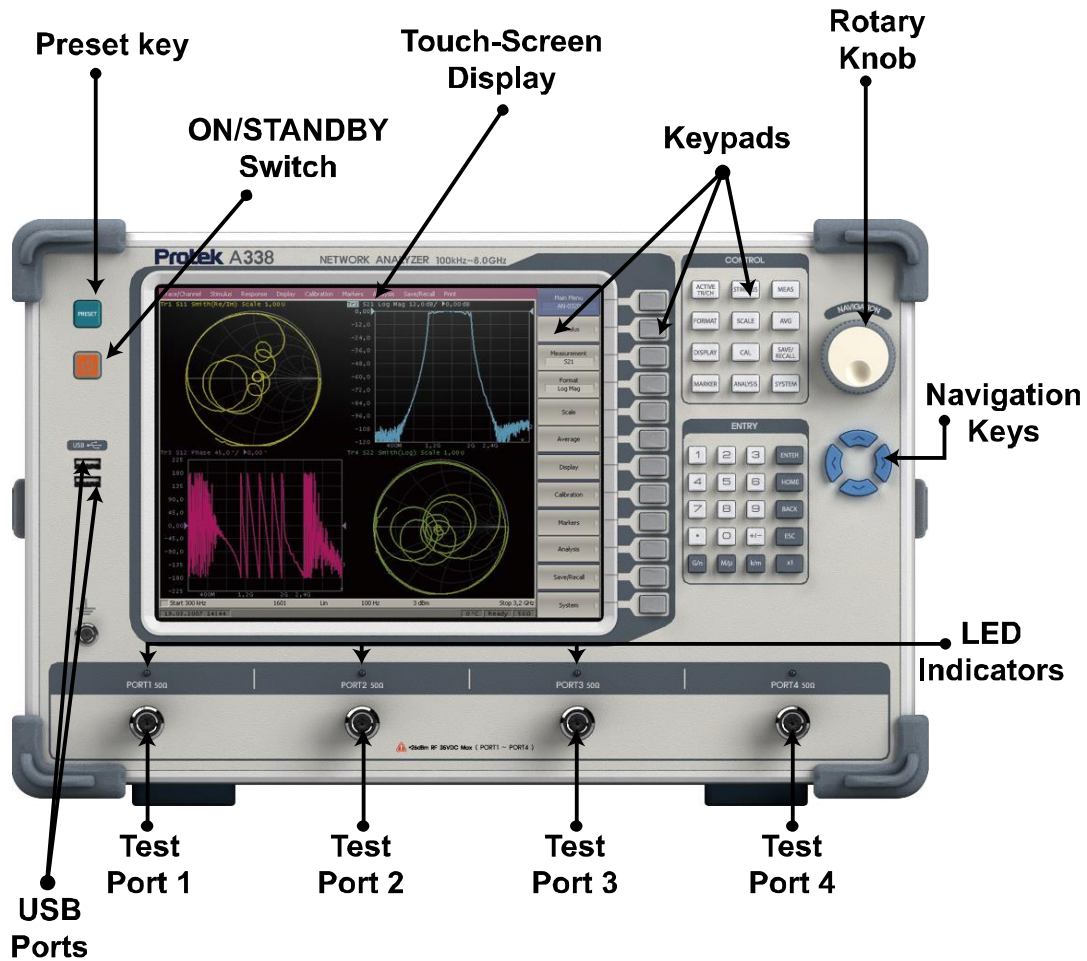

Figure 2.1 A338 4 PORT front panel

2.2.1 Power Switch

Switches the power supply of the Analyzer on and off.
You can turn your Analyzer on/off at any time.

2.2.2 Test Ports



The type-N 50 Ω test ports are intended for DUT connection. A test port can be used either as a source of the stimulus signal or as a receiver of the response signal of the DUT. Only one of the ports can be the source of the signal in a particular moment of time.

If you connect the DUT to only one test port of the Analyzer, you will be able to measure the reflection parameters (e.g. S_{11} or S_{22}) of the DUT.

If you connect the DUT to the all test ports of the Analyzer, you will be able to measure the full S-parameter matrix of the DUT.

Note

LED indicator identifies the test port which is operating as a signal source.

CAUTION

Do not exceed the maximum allowed power of the input RF signal (or maximum DC voltage) indicated on the front panel. This may damage your Analyzer.

2.3 Rear Panel

The rear view of A338 4 PORT is represented in figure 2.2. The rear panel is equipped with the following parts:

- Power cable receptacle;
- External trigger input connector;
- External Reference Frequency input connector;
- Internal Reference Frequency output connector;
- USB 2.0 High Speed;
- Reserved port.

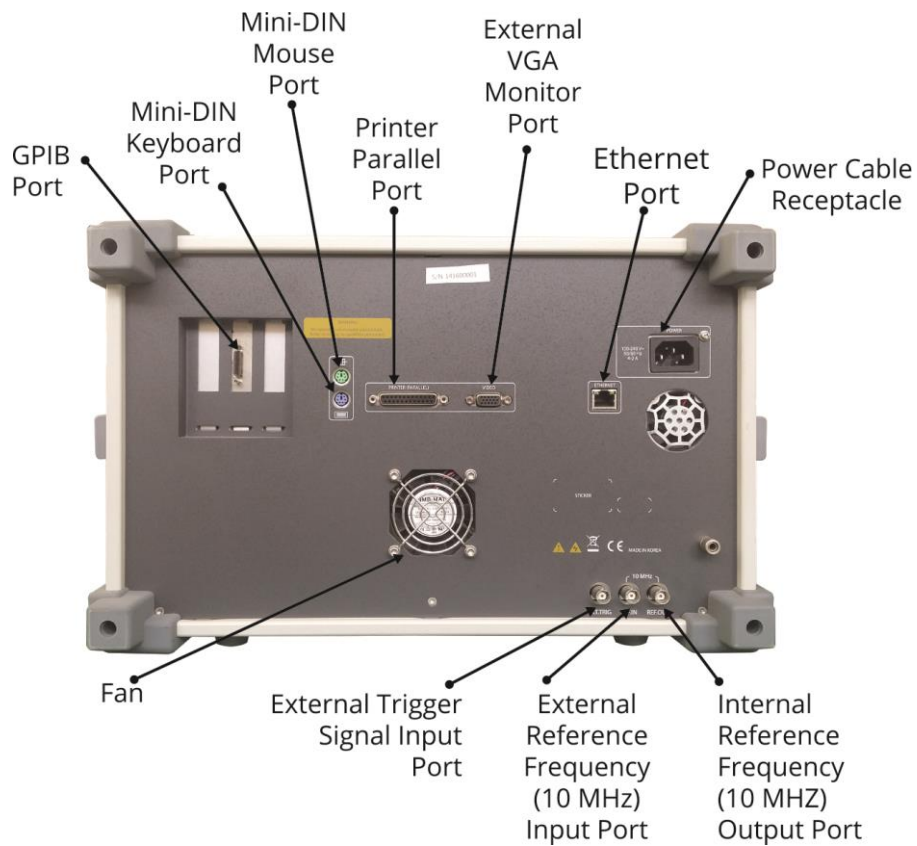

Figure 2.2 A338 4 PORT rear panel

2.3.1 Power Cable Receptacle

Power cable receptacle is intended for 100 VAC to 240 VAC 50/60 Hz power cable connection.

2.3.2 External Trigger Signal Input Connector

This connector allows the user to connect an external trigger source. Connector type is BNC female. TTL compatible inputs of 3 V to 5 V magnitude have up to 1 μ s pulse width. Input impedance at least 10 k Ω .

2.3.3 External Reference Frequency Input Connector

External reference frequency is 10 MHz, input level is 2 dBm \pm 2 dB, input impedance at 10 MHz is 50 Ω . Connector type is BNC female.

2.3.4 Internal Reference Frequency Output Connector

Output reference signal level is 3 dBm \pm 2 dB into 50 Ω impedance. OUT 10 MHz connector type is BNC female.

2.3.5 USB 2.0 High Speed

The USB port is intended for connection to computer.

3 GETTING STARTED

This section represents a sample session of the Analyzer. It describes the main techniques of measurement of reflection coefficient parameters of the DUT. SWR and reflection coefficient phase of the DUT will be analyzed.

For reflection coefficient measurement only one test port of the Analyzer is used. The instrument sends the stimulus to the input of the DUT and then receives the reflected wave. Generally in the process of this measurement the output of the DUT should be terminated with a LOAD standard. The results of these measurements can be represented in various formats.

Typical circuit of reflection coefficient measurement is shown in figure 3.1.

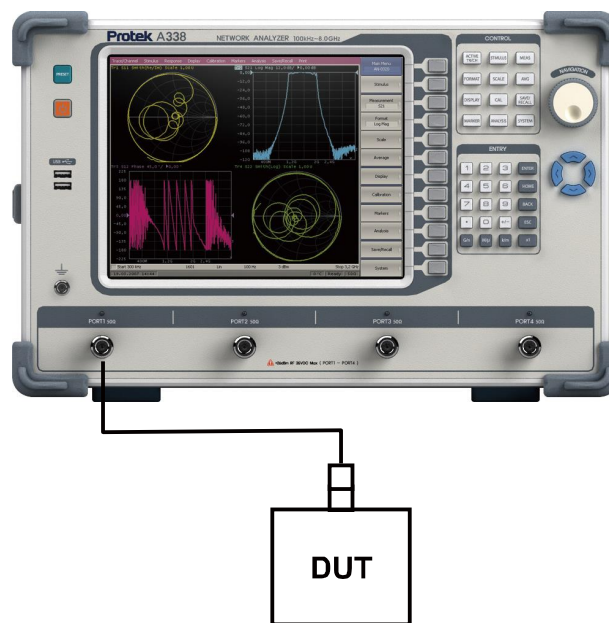

Figure 3.1 Reflection measurement circuit

To measure SWR and reflection coefficient phases of the DUT, in the given example you should go through the following steps:

- Prepare the Analyzer for reflection measurement;
- Set stimulus parameters (frequency range, number of sweep points);
- Set IF bandwidth;
- Set the number of traces to 2, assign measured parameters and display format to the traces;
- Set the scale of the traces;
- Perform calibration of the Analyzer for reflection coefficient measurement;
- Analyze SWR and reflection coefficient phase using markers.

Note	In this section the control over Analyzer is performed by the softkeys located in the right-hand part of the screen. The Analyzer also allows the user to perform quick control by the mouse (See section 4.3).
------	---

3.1 Analyzer Preparation for Reflection Measurement

Turn on the Analyzer and warm it up for the period of time stated in the specifications.

Ready state features	The bottom line of the screen displays the instrument status bar. It should read Ready . Above this bar, the channel status bar is located. The sweep indicator in the left-hand part of this bar should display a progress.
----------------------	---

Connect the DUT to Port 1 of the Analyzer. Use the appropriate cables and adapters for connection of the DUT input to the Analyzer test port. If the DUT input is type-N (male), you can connect the DUT directly to the port.

3.2 Analyzer Presetting

Before you start the measurement session, it is recommended to reset the Analyzer into the initial (known) condition. The initial condition setting is described in Appendix 1.

	<p>To restore the initial condition of the Analyzer, use the following softkeys:</p> <p>System > Preset > OK</p>
---	---

3.3 Stimulus Setting

After you have restored the preset state of the Analyzer, the stimulus parameters will be as follows: frequency range from 100 kHz to 8.0 GHz, sweep type is linear, number of sweep points is 201, and power level is 0 dBm.

For the current example, set the frequency range to from 10 MHz to 3 GHz.

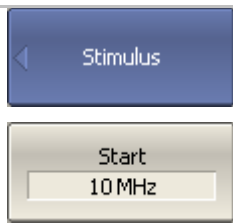
	<p>To set the start frequency of the frequency range to 10 MHz, use the following softkeys:</p> <p>Stimulus > Start</p> <p>Then enter «1», «0» from the keyboard. Complete the setting by pressing «M» key.</p>
---	---

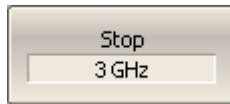

To set the stop frequency of the frequency range to 3 GHz, use the following softkeys:

Stimulus > Stop

Then enter «3» from the keyboard. Complete the setting by pressing «G» key.

To return to the main menu, click the top softkey (colored in blue).

3.4 IF Bandwidth Setting

For the current example, set the IF bandwidth to 3 kHz.

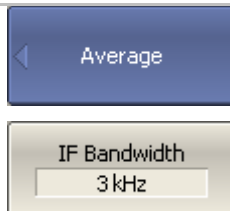

To set the IF bandwidth to 3 kHz, use the following softkeys:

Average > IF Bandwidth

Then enter «3» from the keyboard and complete the setting by pressing «k» key.

To return to the main menu, click the top softkey (colored in blue).

3.5 Number of Traces, Measured Parameter and Display Format Setting

In the current example, two traces are used for simultaneous display of the two parameters (SWR and reflection coefficient phase).



To set the number of traces, use the following softkeys:

Display > Num of Traces > 2

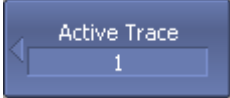
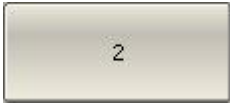

To return to the main menu, click the top softkey (colored in blue).

Before assigning the measurement parameters of a trace, first activate the trace.

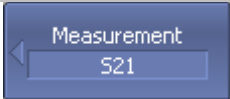

	<p>To activate the second trace, use the following softkeys:</p>
	<p>Display > Active Trace/Channel > Active Trace > 2</p>

To return to the main menu, click the top softkey (colored in blue).

Assign S_{11} -parameter to the second trace. To the first trace this parameter is already assigned by default.

	<p>To assign a parameter to the trace, use the following softkeys:</p>
	<p>Measurement > S11</p>

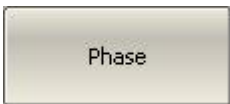
Then assign SWR display format to the first trace and reflection coefficient phase display format to the second trace.

	<p>To set the active trace display format, use the following softkeys:</p>
	<p>Format > SWR (for the first trace),</p>
	<p>Format > Phase (for the second trace).</p>

3.6 Trace Scale Setting

For a convenience in operation, change the trace scale using automatic scaling function.

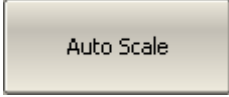
	<p>To set the scale of the active trace by the autoscaling function, use the following softkeys:</p>
	<p>Scale > Auto Scale</p>
<p>To return to the main menu, click the top softkey (colored in blue).</p>	

3.7 Analyzer Calibration for Reflection Coefficient Measurement

Calibration of the whole measurement setup, which includes the Analyzer, cables and other devices, supporting connection to the DUT, allows to considerably enhance the accuracy of the measurement.

To perform full 1-port calibration, you need to prepare the kit of calibration standards: OPEN, SHORT and LOAD. Such a kit has its description and specifications of the standards. To perform proper calibration, you need to select in the program the correct kit type.

In the process of full 1-port calibration, connect calibration standards to the test port one after another, as shown in figure 3.2.

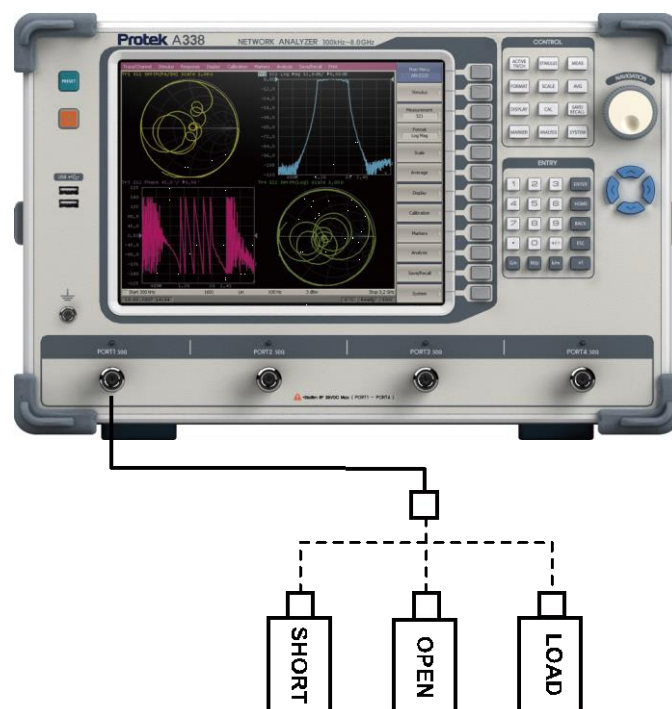
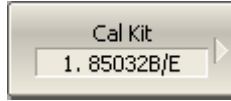
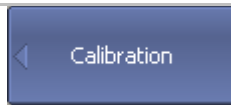

Figure 3.2 Full 1-port calibration circuit

In the current example Agilent 85032E calibration kit is used.



To select the calibration kit, use the following softkeys:

Calibration > Cal Kit

Then select the kit you are using, from the table in the bottom of the screen.

To perform full 1-port calibration, execute measurements of the three standards. After that the table of calibration coefficients will be calculated and saved into the memory of the Analyzer. Before you start calibration, disconnect the DUT from the Analyzer.

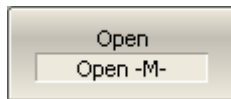
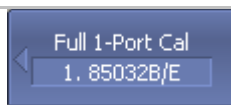

To perform full 1-port calibration, use the following softkeys:

Calibration > Calibrate > Full 1-Port Cal

Connect an OPEN standard and click **Open**.

Connect a SHORT standard and click **Short**.

Connect a LOAD standard and click **Load**.

To complete the calibration procedure and calculate the table of calibration coefficients, click **Apply** softkey.

Then connect the DUT to the Analyzer port again.

3.8 SWR and Reflection Coefficient Phase Analysis Using Markers

This section describes how to determine the measurement values at three frequency points using markers. The Analyzer screen view is shown in figure 3.3. In the current example, a reflection standard of SWR = 1.2 is used as a DUT.

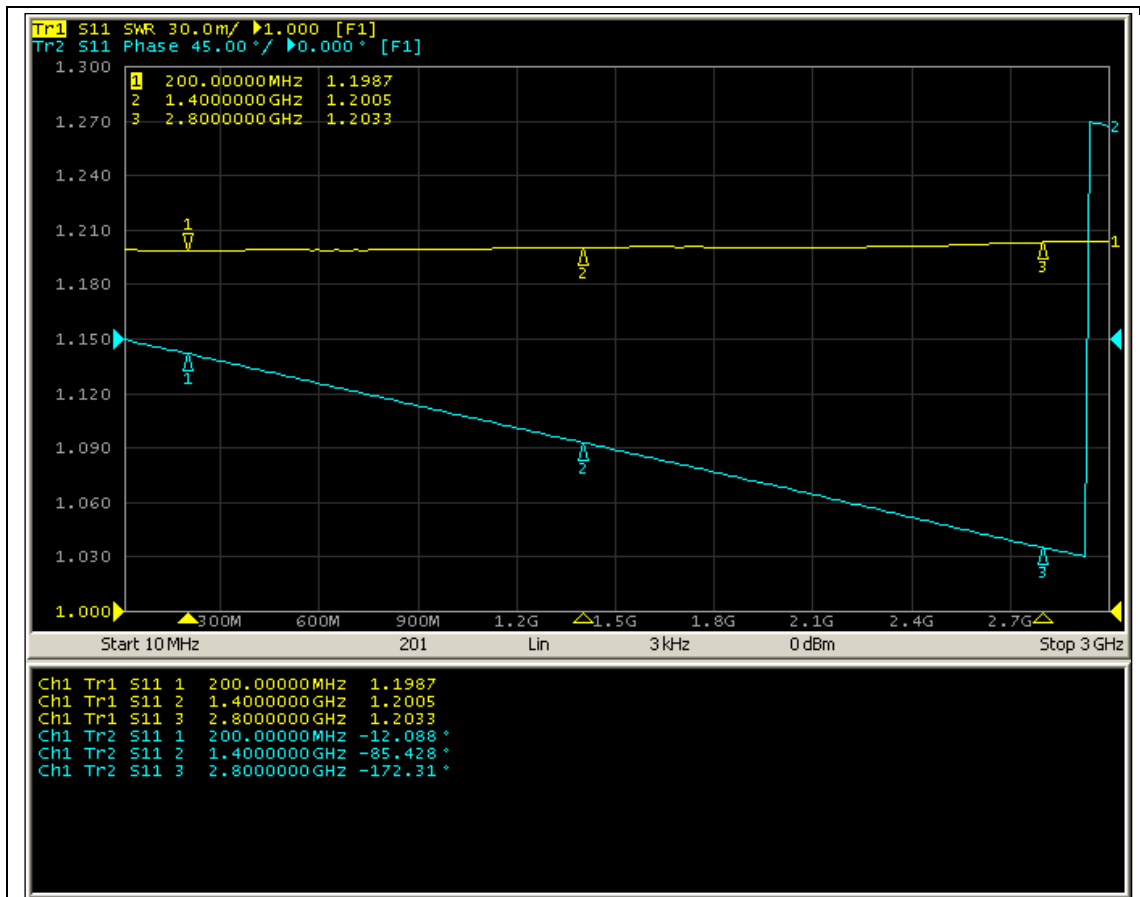
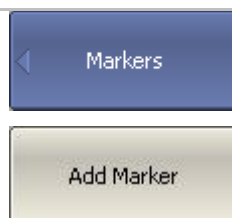

Figure 3.3 SWR and reflection coefficient phase measurement example



To enable a new marker, use the following softkeys:

Markers > Add Marker

Then enter the frequency value in the input field in the graph, e.g. to enter frequency 200 MHz, press «2», «0», «0» and «M» keys on the keypad.

Repeat the above procedure three times to enable three markers in different frequency points.

By default only active trace markers are displayed on the screen. To enable display of two traces simultaneously, first activate the marker table.



To open the marker table, use the following softkeys:

Markers > Properties > Marker Table



4 MEASUREMENT CONDITIONS SETTING

4.1 Screen Layout and Functions

The screen layout is represented in figure 4.1. In this section you will find detailed description of the softkey menu bar, menu bar, and instrument status bar. The channel windows will be described in the following section.

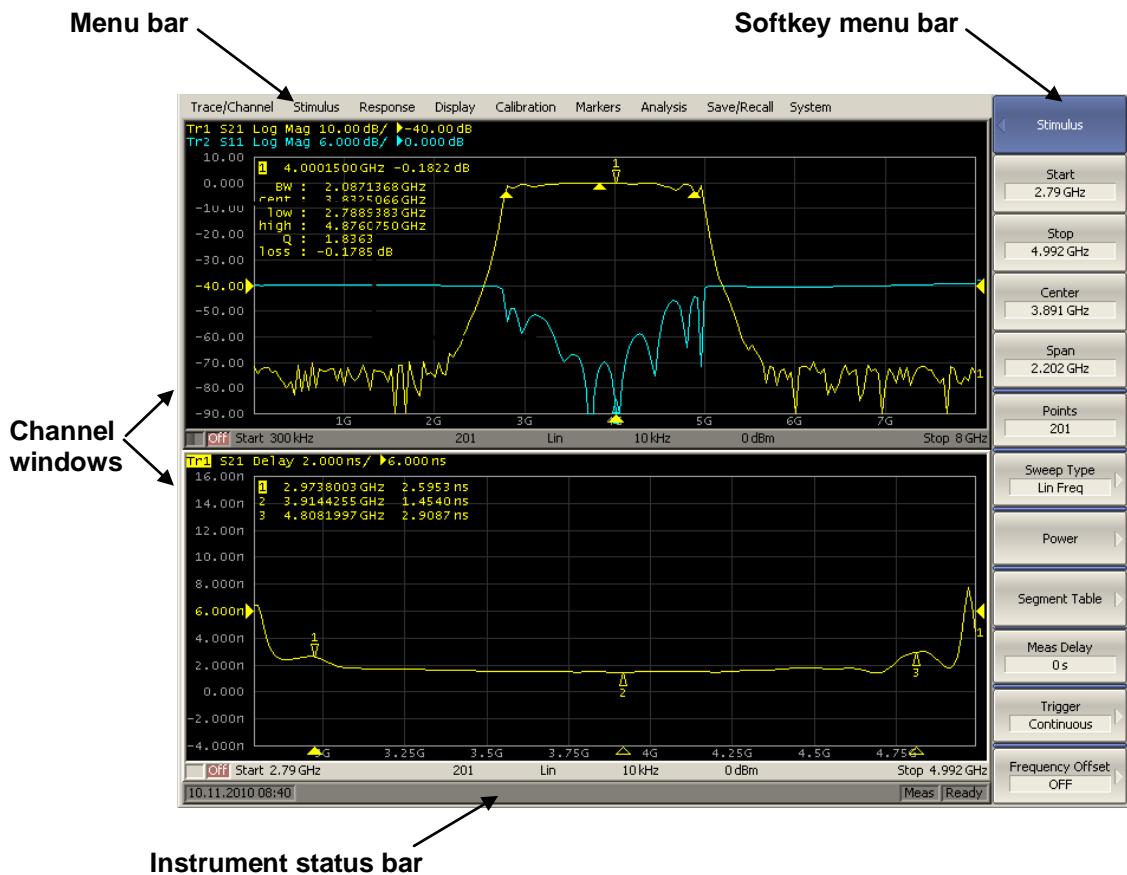

Figure 4.1 Analyzer screen layout

4.1.1 Softkey Menu Bar

The softkey menu bar in the right-hand side of the screen is the main menu of the program.

Note







The top line of the screen represents the menu bar, which enables you direct access to the submenus of the softkey menu. This menu is an auxiliary one and can be hidden.

The softkey menu bar consists of panels, which appear one instead of the other. Each panel represents one of the submenus of the softkey menu. All the panels are integrated into multilevel menu system and allow access to all the functions of the Analyzer.

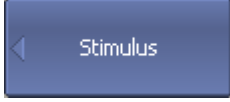
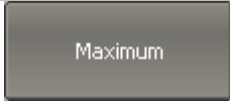
You can manipulate the menu softkeys using a mouse.

Also you can navigate the menu by «↑», «↓», «←», «→», «Enter», «Esc», «Home» keys on the external keyboard.

The types of the softkeys are described below:

	The top softkey is the menu title key. It enables you to return to the upper level of the menu. If it is displayed in blue you can use keyboard to navigate within the softkey menu.
	If the softkey is highlighted in dark gray, pressing «Enter» key on the keyboard will activate the function of this softkey. You can shift the highlight from key to key using «↑» and «↓» arrows on the keyboard.
	A large dot on the softkey indicates the current selection in a list of alternative settings.
	A check mark in the left part of the softkey indicates the active function, which you can switch on/off.
	The softkey with a right arrow enables the access to the lower level of the menu.
	The softkey with a text field allows for the selected function indication.
	The softkey with a value field allows for entering/selection of the numerical settings.
	This navigation softkey appears when the softkey menu overflows the menu screen area. Using this softkey you can scroll down and up the softkey menu.

To navigate in the softkey menu, you can also (additionally to «↑», «↓») use «←», «→», «Esc», «Home» keys of the keyboard:

- «←» key brings up the upper level of the menu;
- «→» key brings up the lower level of the menu, if there is a highlighted softkey with a right arrow;
- «Esc» key functions similar to «←» key;
- «Home» key brings up the main menu.

Note The above keys of the keyboard allow navigation in the softkey menu only if there is no any active entry field. In this case the menu title softkey is highlighted in blue.

4.1.2 Menu Bar

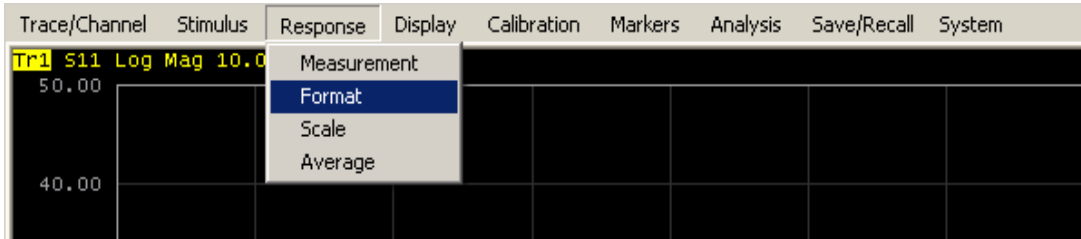

Figure 4.2 Menu bar

The menu bar is located at the top of the screen. This menu is an auxiliary one and enables you direct access to the submenus of the main menu. Also it contains the functions of the most frequently used softkeys. You can hide the menu bar to gain more screen space for the graph area. The menu bar is controlled by the mouse.

Note To hide the menu bar, use the following softkeys:

Display > Properties > Menu Bar

4.1.3 Instrument Status Bar



Figure 4.3 Instrument status bar

The instrument status bar is located at the bottom of the screen.

Table 4.1 Messages in the instrument status bar

Field Description	Message	Instrument Status
DSP status	Not Ready	No communication between DSP and computer.
	Loading	DSP program is loading.
	Ready	DSP is running normally.
Sweep status	Meas	A sweep is in progress.
	Hold	A sweep is on hold.
	Ext	Waiting for trigger, which is set to “External”.
	Man	Waiting for trigger, which is set to “Manual”.
	Bus	Waiting for trigger, which is set to “Bus”.
Calibration	Calibration...	Calibration standard measurement is in progress.
RF signal	RF output Off	Stimulus signal output is turned off.
External reference frequency	ExtRef	External reference frequency input (10 MHz) is turned on.
Display update	Update Off	Display update is turned off.
System correction status	Sys Corr OFF	System correction is turned off (see section 8.4).
Factory calibration error	Power Failure	ROM error of power calibration.
	System Cal Failure	ROM error of system calibration.
External power meter status	Power Meter: message	When external power meter is connected to the Analyzer via USB the following messages are displayed: connection, connection error, ready, measurement, zero setting, zero setting error

4.2 Channel Window Layout and Functions

The channel windows display the measurement results in the form of traces and numerical values. The screen can display up to 16 channel windows simultaneously. Each window corresponds to one logical channel. A logical channel can be represented as a separate analyzer with the following settings:

- Stimulus signal settings (frequency range, power level, sweep type);
- IF bandwidth and averaging;
- Calibration.

Physical analyzer processes the logical channels in succession.

In turn each channel window can display up to 16 traces of the measured parameters. General view of the channel window is represented in figure 4.4.

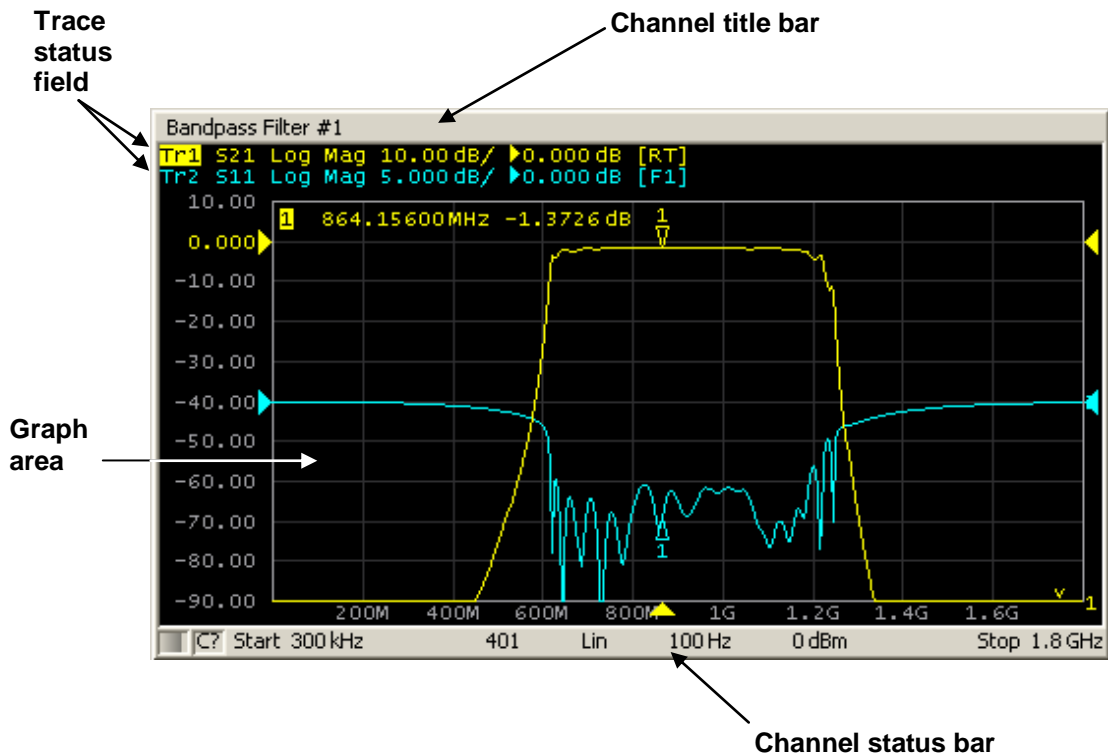

Figure 4.4 Channel window

4.2.1 Channel Title Bar

The channel title feature allows you to enter your comment for each channel window. You can hide the channel title bar to gain more screen space for graph area.

Channel title bar on/off switching	To show/hide the channel title bar, use the following softkeys:
------------------------------------	---

Display > Title Label

Channel title editing	You can access the channel title edit mode by using the following softkeys:
-----------------------	---

Display > Edit Title Label

You can also make it by mouse clicking on the title area in the channel title bar.

4.2.2 Trace Status Field

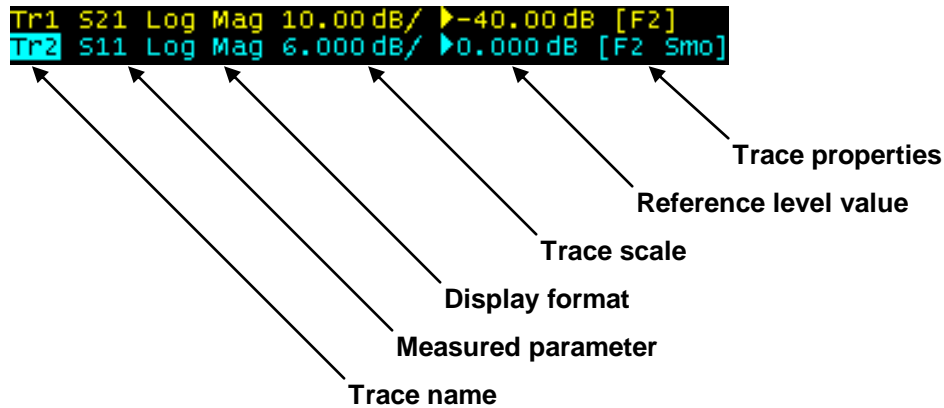

Figure 4.5 Trace status field

The trace status field displays the name and parameters of a trace. The number of lines in the field depends on the number of active traces in the channel.

Note	Using the trace status field you can easily modify the trace parameters by the mouse (as described in section 4.3).
------	---

Each line contains the data on one trace of the channel:

- Trace name from «Tr1» to «Tr16». The active trace name is highlighted in inverted color;
- Measured parameter: **S11**, **S21**, **S12**, **S22**, or absolute power value: **A(n)**, **B(n)**, **R1(n)**, **R2(n)**;
- Display format, e.g. «Log Mag»;
- Trace scale in measurement units per scale division, e.g. «10.0 dB/»;
- Reference level value, e.g. «▶0.00 dB», where «▶» is the symbol of the reference level;
- Trace status is indicated as symbols in square brackets (See table 4.2).

Table 4.2 Trace status symbols definition

Status	Symbols	Definition
Error Correction	RO	OPEN response calibration
	RS	SHORT response calibration
	RT	THRU response calibration
	OP	One-path 2-port calibration
	F1	Full 1-port calibration
	F2	Full 2-port or TRL calibration
	F3	Full 3-port or TRL calibration
	F4	Full 3-port or TRL calibration
	SMC	Scalar mixer calibration
Other Calibrations	RC	Receiver calibration
	PC	Power calibration
Data Analysis	Z0	Port impedance conversion
	Dmb	Fixture de-embedding
	Emb	Fixture embedding
	Pext	Port extension
Trace Display	No indication	Data trace
	D&M	Data and memory traces
	M	Memory trace
	Off	Data and memory traces – off
Math Operations	D+M	Data + Memory
	D–M	Data – Memory
	D*M	Data * Memory
	D/M	Data / Memory
Electrical Delay	Del	Electrical delay other than zero
Smoothing	Smo	Trace smoothing
Gating	Gat	Time domain gating

Table 4.2 Trace status symbols definition (continued)

Conversion	Zr	Reflection impedance
	Zt	Transmission impedance
	Yr	Reflection admittance
	Yt	Transmission admittance
	1/S	S-parameter inversion
	Ztsh	Transmission-shunt impedance
	Ytsh	Transmission-shunt admittance
	Conj	Conjugation

4.2.3 Graph Area

The graph area displays the traces and numeric data.

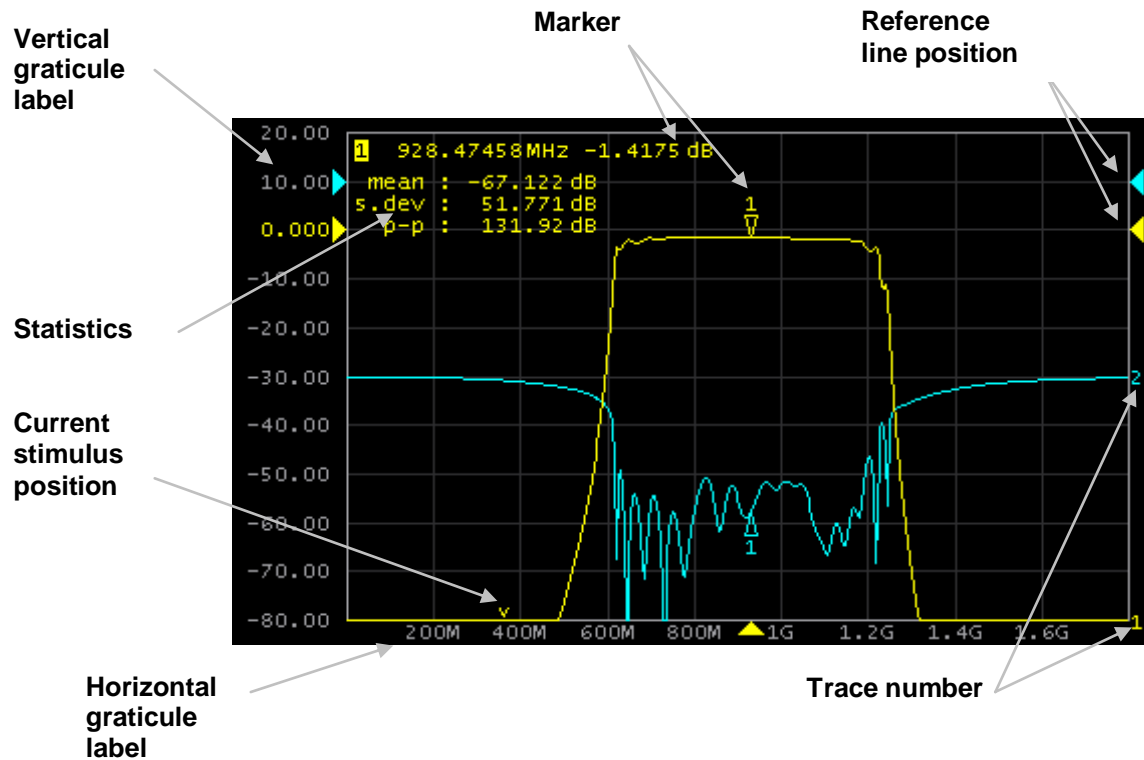

Figure 4.6 Graph area

The graph area contains the following elements:

- *Vertical graticule label* displays the vertical axis numeric data for the active trace. You can set the display of the data for all the traces or hide the vertical graticule label to gain more screen space for the trace display.
- *Horizontal graticule label* displays stimulus axis numeric data (frequency, power level or time). You can also hide the horizontal graticule label to gain more screen space for the trace display.
- *Reference level position* indicates the reference level position of the trace.
- *Markers* indicate the measured values in different points on the active trace. You can enable display of the markers for all the traces simultaneously.
- Marker functions: *statistics, bandwidth, flatness, RF filter*.
- *Trace number* allows trace identification when printed out in black and white.

- *Current stimulus position* indication appears when sweep duration exceeds 1.5 sec.

Note	Using the graticule labels, you can easily modify all the trace parameters by the mouse (as described in section 4.3).
------	--

4.2.4 Trace Layout in Channel Window

If the number of the displayed traces is more than one, you can rearrange the traces to your convenience. You can select display of all the traces in one graph (See figure 4.6) or display of each trace in its individual graphs (See figure 4.7).

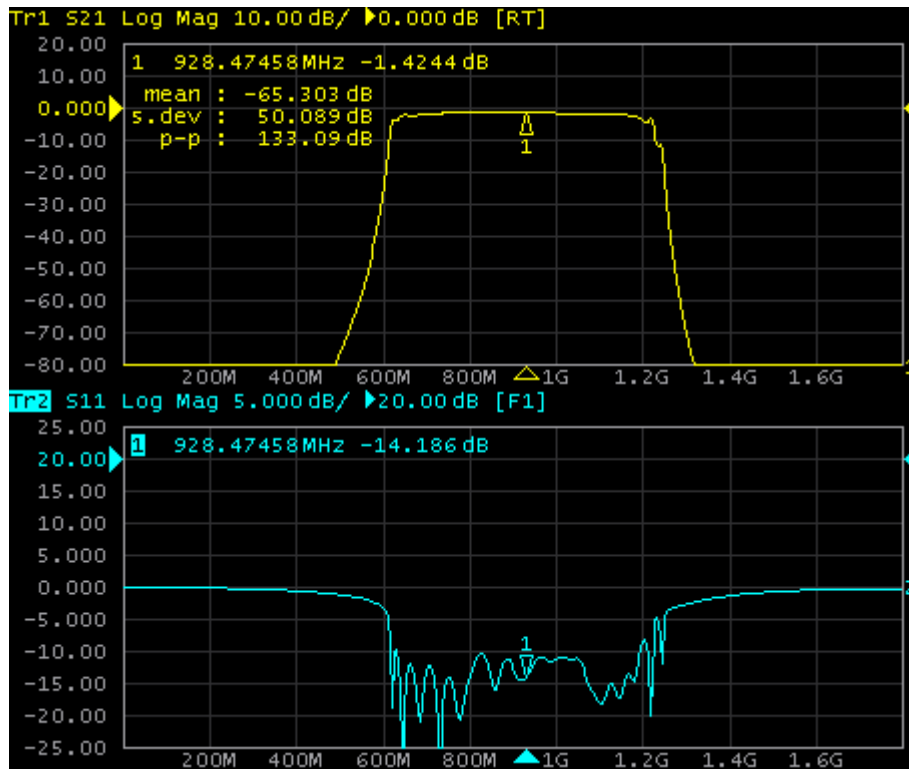

Figure 4.7 Two traces in one channel window (sample)

4.2.5 Markers

The markers indicate the stimulus values and the measured values in selected points of the trace (See figure 4.8).

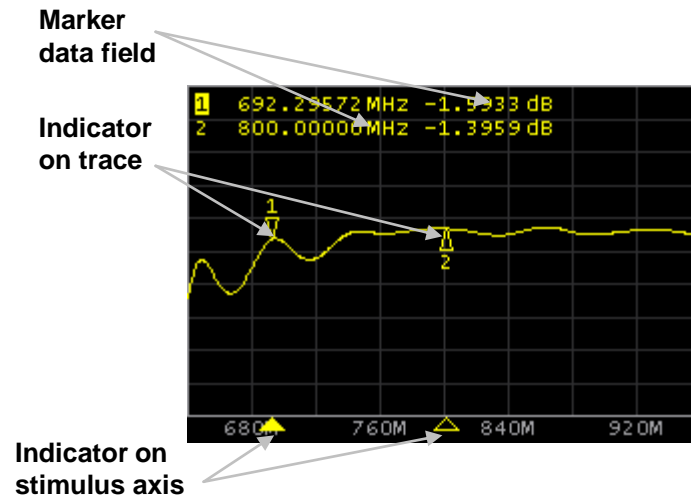

Figure 4.8 Markers

The markers are numbered from 1 to 15. The reference marker is indicated with R symbol. The active marker is indicated in the following manner: its number is highlighted in inverse color, the indicator on the trace is located above the trace, the stimulus indicator is fully colored.

4.2.6 Channel Status Bar

The channel status bar is located in the bottom part of the channel window. It contains the following elements:

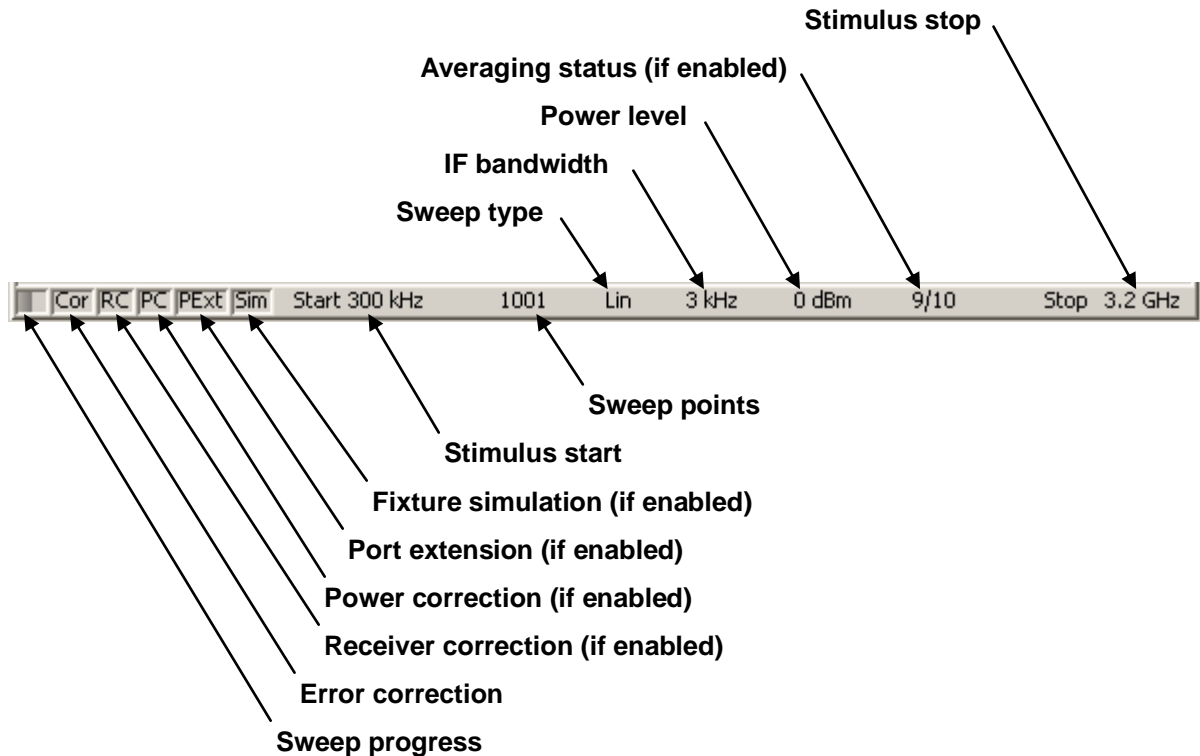

Figure 4.9 Channel status bar

- *Sweep progress* field displays a progress bar when the channel data are being updated.
- *Error correction* field displays the integrated status of error correction for S-parameter traces. The values of this field are represented in table 4.3.
- *Receiver correction* field displays the integrated status of receiver correction for absolute power measurement traces. The values of this field are represented in table 4.4.
- *Power correction* field displays the integrated status of power correction for all the traces. The values of this field are represented in table 4.5.
- *Port extension* field displays the integrated status of execution of this function for S-parameter traces. If the function is enabled for all the traces, you will see black characters on gray background. If the function is enabled just for some of the traces, you will see white characters on red background.

- *Fixture simulation* field displays the integrated status of execution of this function for S-parameter traces. Fixture simulation includes the following operations: Z0 conversion, embedding, de-embedding. If the function is enabled for all the traces, you will see black characters on gray background. If the function is enabled just for some of the traces, you will see white characters on red background.
- *Stimulus start* field allows for display and entry of the start frequency or power, depending on the sweep type. This field can be switched to indication of stimulus center frequency, in this case the word **Start** will change to **Center**.
- *Sweep points* field allows for display and entry of the number of sweep points. The number of sweep points can be set from 2 to 500001.
- *Sweep type* field allows for display and selection of the sweep type. The values of this field are represented in table 4.6.
- *IF bandwidth* field allows for display and setting of the IF bandwidth. The values can be set from 1 Hz to 30 kHz.
- *Power level* field allows for display and entry of the port output power. In power sweep mode the field switches to indication of CW frequency of the source.
- *Averaging status* field displays the averaging status if this function is enabled. The first number is the averaging current counter value, the second one is the averaging factor.
- *Stimulus stop* field allows for display and entry of the stop frequency or power, depending on the sweep type. This field can be switched to indication of stimulus span, in this case the word **Stop** will change to **Span**.

Table 4.3 Error correction field

Symbol	Definition	Note
Cor	Error correction is enabled. The stimulus settings are the same for the measurement and the calibration.	If the function is active for all the traces – black characters on gray background. If the function is active only for some of the traces (other traces are not calibrated) – white characters on red background.
C?	Error correction is enabled. The stimulus settings are not the same for the measurement and the calibration. Interpolation is applied.	
C!	Error correction is enabled. The stimulus settings are not the same for the measurement and the calibration. Extrapolation is applied.	
Off	Error correction is turned off.	For all the traces. White characters on red background.
---	No calibration data. No calibration was performed.	

Table 4.4 Receiver correction field

Symbol	Definition	Note
RC	Receiver correction is enabled. The stimulus settings are the same for the measurement and the calibration.	If the function is active for all the traces – black characters on gray background. If the function is active only for some of the traces (other traces are not calibrated) – white characters on red background.
RC?	Receiver correction is enabled. The stimulus settings are not the same for the measurement and the calibration. Interpolation is applied.	
RC!	Receiver correction is enabled. The stimulus settings are not the same for the measurement and the calibration. Extrapolation is applied.	

Table 4.5 Power correction field

Symbol	Definition	Note
PC	Power correction is enabled. The stimulus settings are the same for the measurement and the calibration.	If the function is active for all the traces – black characters on gray background. If the function is active only for some of the traces (other traces are not calibrated) – white characters on red background.
PC?	Power correction is enabled. The stimulus settings are not the same for the measurement and the calibration. Interpolation is applied.	
PC!	Power correction is enabled. The stimulus settings are not the same for the measurement and the calibration. Extrapolation is applied.	

Table 4.6 Sweep types

Symbol	Definition
Lin	Linear frequency sweep.
Log	Logarithmic frequency sweep.
Segm	Segment frequency sweep.
Pow	Power sweep.

4.3 Quick Channel Setting Using Mouse

This section describes the mouse manipulations, which will enable you to set the channel parameters fast and easy. In a channel window, over the field where a channel parameter can be modified, the mouse pointer will change its form to indicate the edit mode. Apart from that in text and numerical fields the edit mode will be indicated by the «underline» symbol appearance.

Note	The mouse manipulations described in this section will help you to perform the most frequently used settings only. All the channel functions can be accessed via the softkey menu.
------	--

4.3.1 Active Channel Selection

You can select the active channel when two or more channel windows are open. The border line of the active window will be highlighted in light color. To activate another window, make a mouse click within its area.

4.3.2 Active Trace Selection

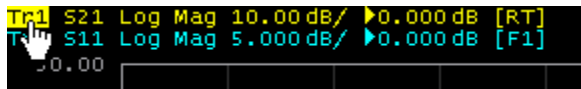

You can select the active trace if the active channel window contains two or more traces. The active trace name will

be highlighted in inverted color. To activate a trace, make a mouse click on the required trace status line, or on the trace curve or the trace marker.

4.3.3 Measured Data Setting

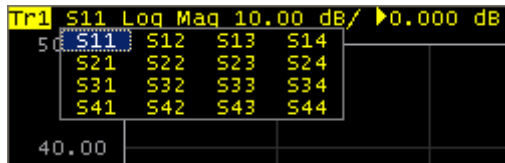

To assign the measured parameters (S_{11} to S_{44}) to a trace, make a mouse click on the S-parameter name in the trace status line and select the required parameter in the drop-down menu.

4.3.4 Display Format Setting



To select the trace display format, make a mouse click on the display format name in the trace status line and select the required format in the drop-down menu.

4.3.5 Trace Scale Setting

The trace scale means the vertical scale division value, which can be set by two methods.

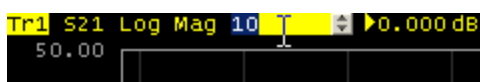

The first method: make a mouse click on the trace scale field in the trace status line and enter the required numerical value.

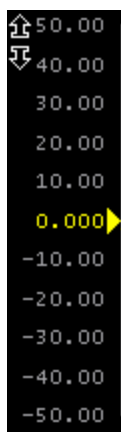

The second method: move the mouse pointer over the vertical scale until the pointer form becomes as shown in the figure. Locate the pointer in the top or bottom parts of the scale, at approximately 10% of the scale height from the top or bottom of the scale. Press left button of the mouse and holding it drag the pointer from the scale center to enlarge the scale, or to the center of the scale to reduce the scale.

4.3.6 Reference Level Setting

The value of the reference level, which is indicated on the vertical scale by «▶» and «◀» symbols, can be set by two methods.

 The first method: make a mouse click on the reference level field in the trace status line and enter the required numerical value.

 The second method: move the mouse pointer over the vertical scale until the pointer form becomes as shown in the figure. Locate the pointer in the center part of the scale. Press left button of the mouse and holding it drag the pointer up the scale to increase the reference level value, or down the scale to reduce the value.

4.3.7 Reference Level Position

 The reference level position, indicated on the vertical scale by «▶» and «◀» symbols, can be set in the following way. Locate the mouse pointer on a reference level symbol until it becomes as shown in the figure. Then drag and drop the reference level symbol to the desired position.

4.3.8 Sweep Start Setting

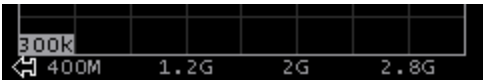
 Move the mouse pointer over the stimulus scale until it becomes as shown in the figure. Locate the mouse pointer in the left part of the scale, at approximately 10% of the scale length from the left. Press left button of the mouse and holding it drag the pointer to the right to increase the sweep start value, or to the left to reduce the value.

4.3.9 Sweep Stop Setting

Move the mouse pointer over the stimulus scale until it becomes as shown in the figure.



Locate the mouse pointer in the right part of the scale, at approximately 10% of the scale length from the right. Press left button of the mouse and holding it drag the pointer to the right to increase the sweep stop value, or to the left to reduce the value.

4.3.10 Sweep Center Setting

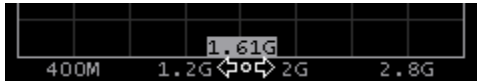

Move the mouse pointer over the stimulus scale until it becomes as shown in the figure. Locate the mouse pointer in the center part of the scale. Press left button of the mouse and holding it drag the pointer to the right to increase the sweep center value, or to the left to reduce the value.

4.3.11 Sweep Span Setting



Move the mouse pointer over the stimulus scale until it becomes as shown in the figure. Locate the mouse pointer in the center part of the scale, at approximately 20% of the scale length from the right. Press left button of the mouse and holding it drag the pointer to the right to increase the sweep span value, or to the left to reduce the value.

4.3.12 Marker Stimulus Value Setting

The marker stimulus value can be set by drag operation or by entering the value using numerical keys of the keyboard.



To drag the marker, first move the mouse pointer on one of the marker indicators until it becomes as shown in the figures.

To enter the numerical value of the stimulus, first activate its field in the marker data line by a mouse click.

4.3.13 Switching between Start/Center and Stop/Span Modes



To switch between the modes Start/Center and Stop/Span, make a mouse click in the respective field of the channel status bar. Label **Start** will be changed with **Center**, and label **Stop** will be changed with **Span**. The layout of the stimulus scale will be changed correspondingly.

4.3.14 Start/Center Value Setting



To enter the **Start/Center** values, activate the respective field in the channel status bar by a mouse click on the numerical value.

4.3.15 Stop/Span Value Setting



To enter the **Stop/Span** values, activate the respective field in the channel status bar by a mouse click on the numerical value.

4.3.16 Sweep Points Number Setting



To enter the number of sweep points, activate the respective field in the channel status bar by a mouse click on the numerical value.

4.3.17 Sweep Type Setting

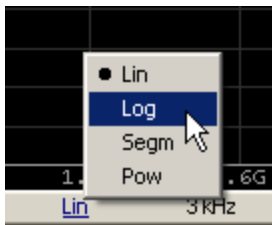

To set the sweep type, click on the respective field in the channel status bar and select the required type in the drop-down menu.

4.3.18 IF Bandwidth Setting

IF bandwidth can be set by selection in the drop-down menu or by entering the value using numerical keys of the keyboard.

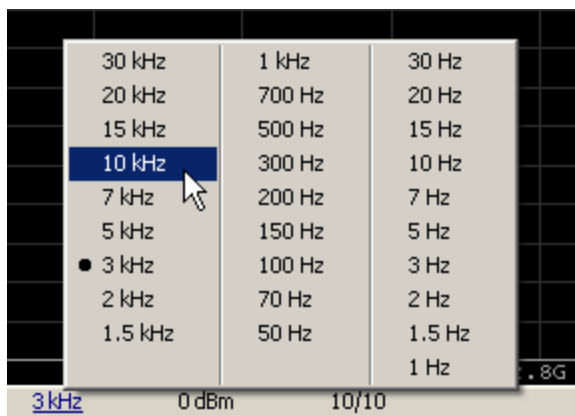

To activate the drop-down menu, make a right mouse click on the IF bandwidth field in the channel status bar.



To enter the IF bandwidth, activate the respective field in the channel status bar by a left mouse click.

4.3.19 Power Level / CW Frequency Setting



To enter the **Power Level/CW Frequency**, activate the respective field in the channel status bar by a mouse click on the numerical value. The parameter displayed in the field depends on the current sweep type: in frequency sweep mode you can enter power level value, in power sweep mode you can enter CW frequency value.

4.4 Channel and Trace Display Setting

The Analyzer supports 16 channels, which allow measurements with different stimulus parameter settings. The parameters related to a logical channel are listed in table 4.7.

4.4.1 Channel Window Allocating

A channel is represented on the screen as an individual channel window. The screen can display from 1 to 16 channel windows simultaneously. By default one channel window opens. If you need to open two or more channel windows select one of the layouts shown below.

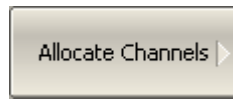
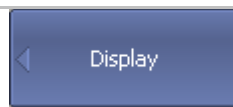

To set the channel window layout, use the following softkeys:

Display > Allocate Channels

Then select the required number and layout of the channel windows in the menu.

The available options of number and layout of the channel windows on the screen are as follows:



In accordance with the layouts, the channel windows do not overlap each other. The channels open starting from the smaller numbers.

Note

For each open channel window, you should set the stimulus parameters, make other settings, and perform calibration.

Before you start a channel parameter setting or calibration, you need to select this channel as active.

The measurements are executed for open channel windows in succession. Measurements for hidden channel windows are not executed.

4.4.2 Number of Traces Setting

Each channel window can contain up to 16 different traces. Each trace is assigned the measured parameter (S-parameter), display format and other parameters. The parameters related to a trace are listed in table 4.8.

The traces can be displayed in one graph, overlapping each other, or in separate graphs of a channel window. The trace settings are made in two steps: trace number setting and trace layout setting in the channel window. By default a channel window contains one trace. If you need to enable two or more traces, set the number of traces as described below.



To set the number of the traces, use the following softkeys:

Display > Num Of Traces

Then select the number of traces from the menu.

All the traces are assigned their individual names, which cannot be changed. The trace name contains its number. The trace names are as follows: **Tr1, Tr2 ... Tr16**.

Each trace is assigned some initial settings: measured parameter, format, scale, and color, which can be modified by the user.

- By default the measured parameters are set in the following succession: S_{11} , S_{21} , S_{31} , ... S_{44} . After that the measurements repeat in cycles.
- By default the display format for all the traces is set to logarithmic magnitude (dB).
- The scale parameters by default are set as follows: division is set to 10 dB, reference level value is set to 0 dB, reference level position is in the middle of the graph.
- The trace color is determined by its number. You can change the color for all the traces with the same number.

4.4.3 Trace Allocating

By default all the traces are displayed in channel window, overlapping each other. If you need to display the traces in separate graphs, set the number and layout of the graphs in the channel window as shown below.

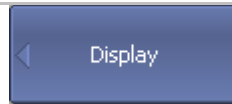

To allocate the traces in a channel window, use the following softkeys:

Display > Allocate Traces

Then select the required number and layout of the separate trace graphs in the menu.

The available options of number and layout of the trace graphs of one channel window are as shown in section 4.4.1.

Compared to channel windows, number and layout of the trace graphs are not correlated. Number of traces and number of graphs are set independently.

- If the number of traces and the number of graphs are equal, all the traces will be displayed separately, each in its individual graph.
- If the number of traces is greater than the number of graphs, traces will be assigned successively (beginning from the smallest trace number) to the available graphs. When all the graphs become occupied, the process will continue from the first graph (the following in succession traces will be added in the graphs).
- If the number of traces is smaller than the number of graphs, empty graphs will be displayed.

If two or more traces are displayed in one graph, the vertical scale will be shown for the active trace.

Note

The Analyzer offers feature of showing the vertical graticule label for all the traces in the graph. By default this feature is set to off. For details see section 8.6.

If two or more traces are displayed in one graph, the markers' data will be shown for the active trace.

Note

To display the marker data for all the traces simultaneously, there are two options: use marker table feature (See section 6.1.6.2) or deactivate identification of the active trace marker only, which is set by default (See section 6.1.6.4).

Stimulus axis is the same for all the traces of the channel, except for the conditions when time domain transformation is applied to some of the traces. In this case the displayed stimulus axis will refer to the active trace.

Table 4.7 Channel parameters

N	Parameter Description
1	Sweep Type
2	Sweep Range
3	Number of Sweep Points
4	Stimulus Power Level
5	Power Slope Feature
6	CW Frequency
7	Segment Sweep Table
8	Trigger Mode
9	IF Bandwidth
10	Averaging
11	Calibration
12	Fixture Simulator

Table 4.8 Trace parameters

N	Parameter Description
1	Measured Parameter (S-parameter)
2	Display Format
3	Reference Level Scale, Value and Position
4	Electrical Delay, Phase Offset
5	Memory Trace, Math Operation
6	Smoothing
7	Markers
8	Time Domain
9	Parameter Transformation
10	Limit Test

4.4.4 Trace/Channel Activating

The control commands selected by the user are applied to the active channel or the active trace, respectively.

The border line of the active channel window is highlighted in light color. The active trace belongs to the active channel and its title is highlighted in inverse color.

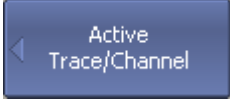
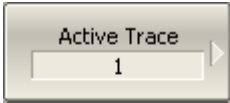
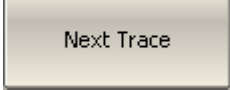
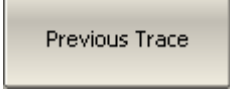
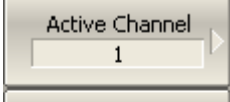
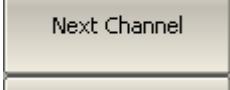
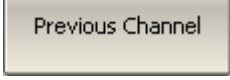

Before you set a channel or trace parameters, first you need to activate the channel or trace, respectively.

	<p>To activate a trace/channel, use the following softkeys:</p>
	<p>Display > Active Trace/Channel</p>
	<p>Then activate the trace by entering the number in the Active Trace softkey or using Previous Trace or Next Trace softkeys.</p>
	<p>Active channel can be selected in similar way.</p>
	
	
	

4.4.5 Active Trace/Channel Window Maximizing

When there are several channel windows displayed, you can temporarily maximize the active channel window to full screen size. The other channel windows will be hidden, but this will not interrupt the measurements in those channels.

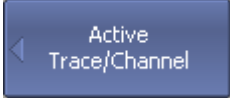
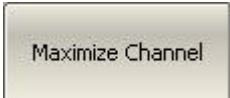
Similarly, when there are several traces displayed in a channel window, you can temporarily maximize the active trace. The other traces will be hidden, but this will not interrupt the measurements of those traces.

	<p>To enable/disable active channel maximizing function, use the following softkeys:</p>
	<p>Display > Active Trace/Channel > Active Channel</p>
	<p>To enable/disable active trace maximizing function, use the following softkeys:</p>
	<p>Display > Active Trace/Channel > Active Trace</p>





Note	Channel and trace maximizing function can be controlled by a double mouse click on the channel/trace.
------	---

4.5 Stimulus Setting

The stimulus parameters are set for each channel. Before you set the stimulus parameters of a channel, make this channel active.

Note	To make the measurement more accurate, perform measurements with the same stimulus settings as were used for the calibration.
------	---

4.5.1 Sweep Type Setting

	<p>To set the sweep type, use the following softkeys:</p> <p>Stimulus > Sweep Type</p>
	<p>Then select the sweep type:</p>
	<ul style="list-style-type: none"> ▪ Lin Freq: Linear frequency sweep
	<ul style="list-style-type: none"> ▪ Log Freq: Logarithmic frequency sweep
	<ul style="list-style-type: none"> ▪ Segment: Segment frequency sweep
	<ul style="list-style-type: none"> ▪ Power Sweep: Power sweep

4.5.2 Sweep Span Setting

The sweep range should be set for linear and logarithmic frequency sweeps (Hz) and for linear power sweep (dBm). The sweep range can be set as Start / Stop or Center / Span values of the range.

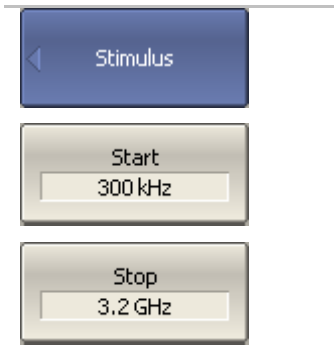
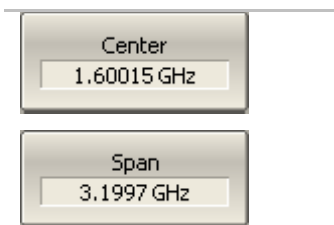
	<p>To enter the start and stop values of the sweep range, use the following softkeys:</p> <p>Stimulus > Start Stop</p>
	<p>To enter center and span values of the sweep range, use the following softkeys:</p> <p>Stimulus > Center Span</p>
<p>Note</p>	<p>If the power sweep is activated, the values on the Start, Stop, Center, and Span softkeys will be represented in dBm.</p>

4.5.3 Sweep Points Setting

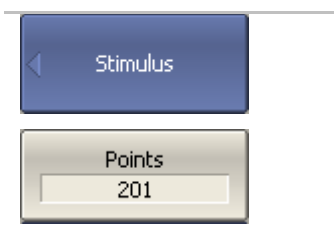

The number of sweep points should be set for linear and logarithmic frequency sweeps, and for linear power sweep.

	<p>To enter the number of sweep points, use the following softkeys:</p> <p>Stimulus > Points</p>
---	--

4.5.4 Stimulus Power Setting

The stimulus power level should be set for linear and logarithmic frequency sweeps. For the segment sweep type, the method of power level setting described in this section can be used only if the same power level is set for all the segments of the sweep. For setting of individual power level for each segment see section 4.5.8.

By default the power levels of all the test ports are set to equal value. This function is called Port Couple. The user can disable this function and set power level for each port individually.

 <p>Stimulus Power 0 dBm</p>	<p>To enter the power level value, when Power Couple function is ON, use the following softkeys:</p> <p>Stimulus > Power > Power</p>
 <p>Port Couple OFF</p> <p>Port Power Port 1 -10 dBm Port 2 0 dBm Port 3 0 dBm Port 4 0 dBm</p>	<p>To set the power level for each port individually, first disable the Power Couple function:</p> <p>Stimulus > Power > Power Couple (OFF)</p> <p>Then set the power level for each port:</p> <p>Stimulus > Power > Port Power</p>



4.5.5 Power Slope Feature

The power slope feature allows for compensation of power attenuation with the frequency increase, in the fixture wire. The power slope can be set for linear, logarithmic and segment frequency sweeps.

 <p>Power Slope 0 dB/GHz</p> <p>Slope OFF</p>	<p>To enter the power slope value, use the following softkeys:</p> <p>Stimulus > Power > Slope (dB/GHz)</p> <p>To enable/disable the power slope function, use the following softkeys:</p> <p>Stimulus > Power > Slope (On/Off)</p>
--	---

4.5.6 CW Frequency Setting

CW frequency setting determines the source frequency for the linear power sweep.

	<p>To enter the CW frequency value, use the following softkeys:</p>
	<p>Stimulus > Power > CW Freq</p>

4.5.7 RF Out Function

RF Out function allows temporary disabling of stimulus signal. While the stimulus is disabled the measurements cannot be performed.

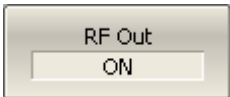
	<p>To disable/enable stimulus, use the following softkeys:</p>
	<p>Stimulus > Power > RF Out</p>

Note RF Out function is applied to the whole Analyzer, not to some channels. The indication about it will appear in the instrument status bar (See section 4.1.3).

4.5.8 Segment Table Editing

Segment table determines the sweep rule when segment sweep is activated.

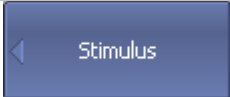
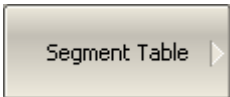
	<p>To open the segment table, use the following softkeys:</p>
	<p>Stimulus > Segment Table</p>

When you switch to the **Segment Table** submenu, the segment table will open in the lower part of the screen. When you exit the **Segment Table** submenu, the segment table will become hidden.

The segment table layout is shown below. The table has three mandatory columns: frequency range and number of sweep points, and three columns, which you can enable/disable: IF bandwidth, power level and delay time.



	Start	Stop	Points	IFBW	Power
1	300 kHz	800 MHz	11	100 Hz	10 dBm
2	800 MHz	1.12 GHz	51	3 kHz	0 dBm
3	1.12 GHz	1.99 GHz	101	30 kHz	-10 dBm
4	1.99 GHz	2.28 GHz	51	3 kHz	0 dBm
5	2.28 GHz	3.2 GHz	11	100 Hz	10 dBm

Total Points: 225

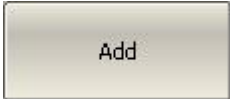
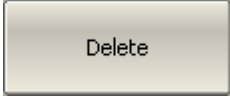

Each row describes one segment. The table can contain one or more rows, up to 20001 (the total number of sweep points of all the segments).

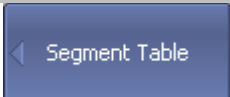
	<p>To add a segment to the table, click Add softkey. The new segment row will be entered below the highlighted one.</p>
	<p>To delete a segment, click Delete softkey. The highlighted segment will be deleted.</p>
	

For any segment it is necessary to set the mandatory parameters: frequency range and number of sweep points. The frequency range can be set either as Start / Stop, or as Center / Span.

	<p>To set the frequency range representation mode, click Freq Mode softkey to select between Start/Stop and Center/Span options.</p>
	

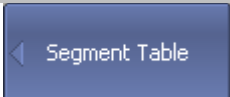

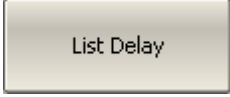
For any segment you can enable the additional parameter columns: IF bandwidth, power level, and delay time. If such a column is disabled, the corresponding value set for linear sweep will be used (same for all the segments).

	
	<p>To enable the IF bandwidth column, click List IFBW softkey.</p>
	<p>To enable the power level column, click List Power softkey.</p>
	<p>To enable the delay time column, click List Delay softkey.</p>

To set a parameter, make a mouse click on its value field and enter the value. To navigate in the table you can use the keys of the keyboard.

Note	The adjacent segments do not overlap in the frequency domain.
------	---

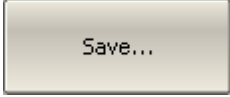
The segment table can be saved into *.lim file to a hard disk and later recalled.

	<p>To save the segment table, click Save... softkey. Then enter the file name in the appeared dialog.</p>
	
	<p>To recall the segment table, click Recall... softkey. Then select the file name in the appeared dialog.</p>

Segment sweep graph has two methods of frequency axis representation. The axis can display the frequencies of the measurement points. For some cases it can be helpful to have the frequency axis displayed in sequential numbers of the measurement points.

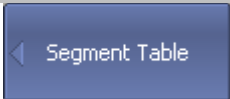
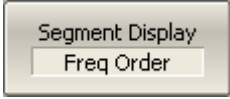
	<p>To set the frequency axis display mode, click Segment Display softkey and select Freq Order or Base Order option.</p>
	

4.5.9 Measurement Delay

Measurement delay function allows to add additional time interval at each measurement point between the moment when the source output frequency becomes stable and the moment of measurement start. This capability can be useful for measurements in narrowband circuits with transient period longer than the measurement in one point.

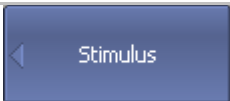
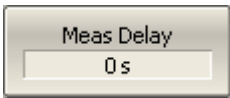
	<p>To set the time of measurement delay, use the following softkeys:</p>
	<p>Stimulus > Meas Delay</p>

4.6 Trigger Setting

The *trigger mode* determines the sweep actuation of the channel at a *trigger signal* detection. A channel can operate in one of the following three trigger modes:









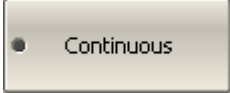
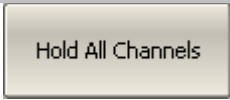

- Continuous – a sweep actuation occurs every time a trigger signal is detected;
- Single – one sweep actuation occurs at one trigger signal detection after the mode has been enabled, after the sweep is complete the channel turns to hold mode;

- Hold – sweep actuation is off in the channel, the trigger signals do not affect the channel.

The trigger signal influences the whole Analyzer and controls the triggering of all the channels in the following manner. If more than one channel windows are open, the trigger activates the successive measurement of all the channels, which are not in hold mode. Before the measurement of all the channels is complete, all the new triggers will be ignored. When the measurement of all the channels is complete, if there is at least one channel in continuous trigger mode, the Analyzer will turn to waiting for a trigger state.

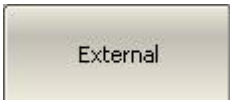

The *trigger source* can be selected by the user from the following four available options:

- Internal – the next trigger signal is generated by the Analyzer on completion of each sweep;
- External – the external trigger input is used as a trigger signal source;
- Manual – the trigger signal is generated by pressing the corresponding softkey.
- Bus – the trigger signal is generated by a command communicated from an external computer from a program controlling the Analyzer via COM/DCOM.



   	<p>To set the trigger mode, use the following softkeys:</p> <p>Stimulus > Trigger</p> <p>Then select the required trigger mode:</p> <ul style="list-style-type: none"> ▪ Hold ▪ Single ▪ Continuous
 	<p>Hold All Channels and Continuous All Channels softkeys turn all the channels to the respective mode.</p>
 	<p>Restart softkey aborts the sweep and returns the trigger system to the waiting for a trigger state.</p> <p>Trigger softkey generates the trigger in manual trigger mode.</p>
    	<p>To set the trigger source, use the following softkeys:</p> <p>Stimulus > Trigger > Trigger Source</p> <p>Then select the required trigger source:</p> <ul style="list-style-type: none"> ▪ Internal ▪ External ▪ Manual ▪ Bus

4.6.1 Point Feature for the External Trigger

By default the trigger provides a sweep measurement at every trigger event for external, manual and bus sources. For the external trigger source the point trigger feature provides a point measurement at every trigger event.

	<p>To enable the point trigger feature for external trigger source, use the following softkeys:</p>
	<p>Stimulus > Trigger > Ext Trig Event > On Point</p>
	

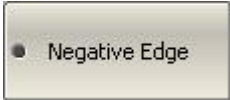
4.6.2 External Trigger Polarity Setting

	<p>To select external trigger polarity, use the following softkeys:</p>
	<p>Stimulus > Trigger > Ext Trig Polarity > { Negative Edge Positive Edge }</p>
	

4.7 Measurement Parameters Setting

4.7.1 S-Parameters

For high-frequency network analysis the following terms are applied: incident, reflected and transmitted waves, transferred in the circuits of the setup (See figure 4.10).

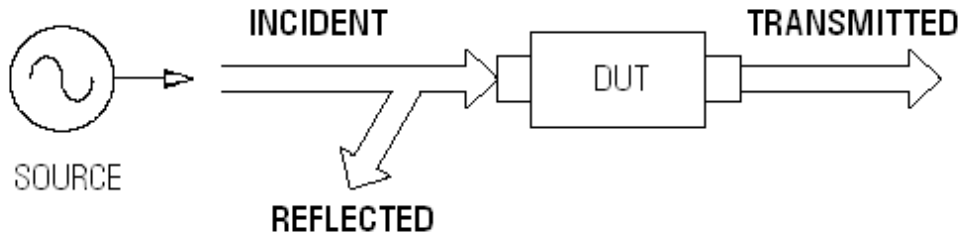

Figure 4.10

Measurement of magnitude and phase of incident, reflected and transmitted signals allow to determine the S-parameters (scattered parameters) of the DUT. An S-parameter is a relation between the complex magnitudes of the two waves:

$$S_{nm} = \frac{\text{input signal at Port } m}{\text{output signal at Port } n}$$

The Analyzer allows measurement of the full scattering matrix of a 4-port DUT:

$$\mathbf{S} = \begin{bmatrix} S_{11} & S_{12} & S_{13} & S_{14} \\ S_{21} & S_{22} & S_{23} & S_{24} \\ S_{31} & S_{32} & S_{33} & S_{34} \\ S_{41} & S_{42} & S_{43} & S_{44} \end{bmatrix}$$

When a stimulus is applied to one of the test ports, the Analyzer measures 4 S-parameters, which constitute one column in S-parameter matrix. To have the full matrix, the Analyzer applies stimulus to all the four test ports one after another.

4.7.2 S-Parameter Setting

A measured parameter (S_{11} , S_{21} , ... S_{44}) is set for each trace. Before you select the measured parameter, first activate the trace.

<div style="background-color: #4a7ebb; color: white; padding: 2px; border: 1px solid black;"> S-Parameter ← S11 </div> <div style="background-color: #d9d9d9; padding: 2px; border: 1px solid black; margin-top: 2px;"> ● S11 </div> <div style="background-color: #d9d9d9; padding: 2px; border: 1px solid black; margin-top: 2px;"> S21 </div> <div style="text-align: center; margin-top: 5px;"> ... </div> <div style="background-color: #d9d9d9; padding: 2px; border: 1px solid black; margin-top: 2px;"> S44 </div>	<p>To set the measured parameter, use the following softkey:</p> <p>Measurement > S-parameter</p> <p>Then select the required parameter by the corresponding softkey.</p>
---	---

4.7.3 Absolute Measurements

The absolute measurement is the measurement of absolute power of a signal at a receiver input. Unlike relative measurements of S-parameters, which represent a relation between the signals at inputs of two receivers, absolute measurements determine the signal power at input of one receiver. A 4-port Analyzer has eight independent receivers: four test signal receivers **T1**, **T2**, **T3**, **T4** and four reference signal receivers **R1**, **R2**, **R3**, **R4** (See figure 4.11).

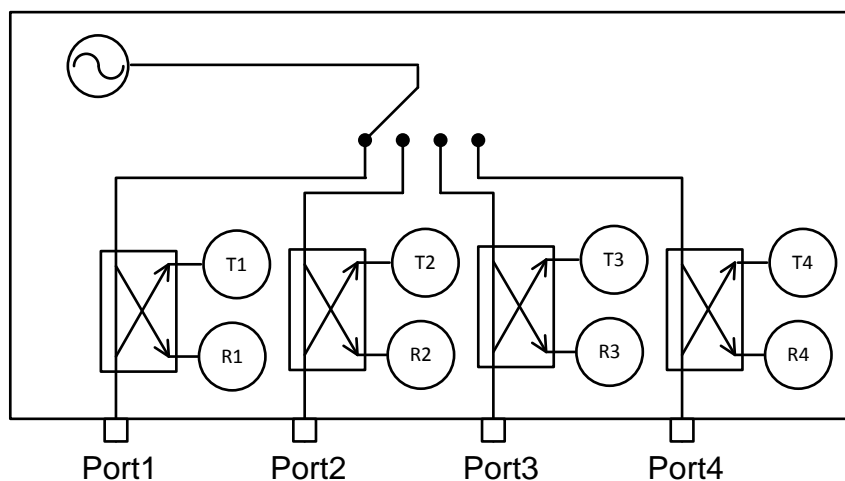

Figure 4.11 Analyzer block diagram

There are 32 types of absolute measurements depending on the combination of the receiver and source port numbers (See table 4.10):

Table 4.10 Absolute measurements

Symbols	Definition
T1(n)	Test signal receiver of Port 1 (Source Port n)
T2(n)	Test signal receiver of Port 2 (Source Port n)
T3(n)	Test signal receiver of Port 3 (Source Port n)
T4(n)	Test signal receiver of Port 4 (Source Port n)
R1(n)	Reference signal receiver of Port 1 (Source Port n)
R2(n)	Reference signal receiver of Port 2 (Source Port n)
R3(n)	Reference signal receiver of Port 3 (Source Port n)
R4(n)	Reference signal receiver of Port 4 (Source Port n)

4.7.4 Absolute Measurement Setting

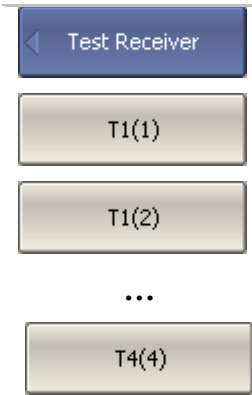
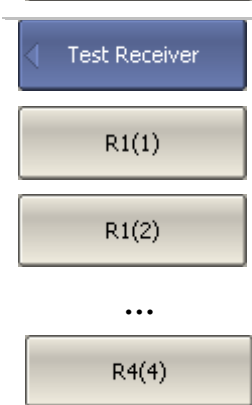
	<p>To select the test signal receiver measurement, click softkeys:</p> <p>Measurement > Test Receiver</p> <p>Then select the required parameter by the corresponding softkey.</p>
	<p>To select the reference signal receiver measurement, click softkeys:</p> <p>Measurement > Reference Receiver</p> <p>Then select the required parameter by the corresponding softkey.</p>
<p>Note</p>	<p>In absolute measurement mode, dBm measurement units will be used for logarithmic magnitude format, W measurement units will be used for measurements in linear magnitude format. Other formats are not applied to absolute measurements as power is measured in scalar values.</p>

4.8 Format Setting

The Analyzer offers the display of the measured S-parameters on the screen in three formats:

- rectangular format;
- polar format;
- Smith chart format.

4.8.1 Rectangular Formats

In this format, stimulus values are plotted along X-axis and the measured data are plotted along Y-axis (See figure 4.12).

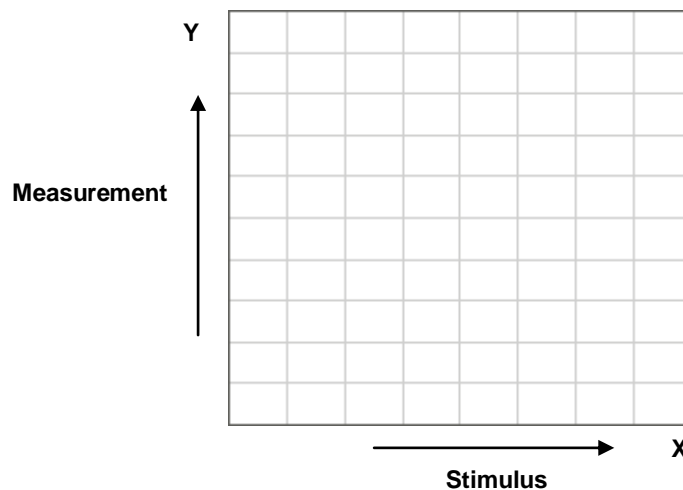

Figure 4.12 Rectangular format

To display S-parameter complex value along Y-axis, it should be transformed into a real number. Rectangular formats involve various types of transformation of an S-parameter $S = a + j \cdot b$, where:

- a – real part of S-parameter complex value;
- b – imaginary part of S-parameter complex value.

There are eight types of rectangular formats depending on the measured value plotted along Y-axis (See table 4.11).

Table 4.11 Rectangular formats

Format Type Description	Label	Data Type (Y-axis)	Measurement Unit (Y-axis)
Logarithmic Magnitude	Log Mag	S-parameter logarithmic magnitude: $20 \cdot \log S $, $ S = \sqrt{a^2 + b^2}$	Decibel (dB)
Voltage Standing Wave Ratio	SWR	$\frac{1 + S }{1 - S }$	Abstract number
Phase	Phase	S-parameter phase from -180° to $+180^\circ$: $\frac{180}{\pi} \cdot \operatorname{arctg} \frac{a}{b}$	Degree ($^\circ$)
Expanded Phase	Expand Phase	S-parameter phase, measurement range expanded to from below -180° to over $+180^\circ$	Degree ($^\circ$)
Group Delay	Group Delay	Signal propagation delay within the DUT: $-\frac{d\varphi}{d\omega}$, $\varphi = \operatorname{arctg} \frac{a}{b}$, $\omega = 2\pi \cdot f$	Second (sec.)
Linear Magnitude	Lin Mag	S-parameter linear magnitude: $\sqrt{a^2 + b^2}$	Abstract number
Real Part	Real	S-parameter real part: $a = \operatorname{re}(S)$	Abstract number
Imaginary Part	Imag	S-parameter imaginary part: $b = \operatorname{im}(S)$	Abstract number

4.8.2 Polar Format

Polar format represents the measurement results on the pie chart (See figure 4.13). The distance to a measured point from the graph center corresponds to the magnitude of its

value. The counterclockwise angle from the positive horizontal axis corresponds to the phase of the measured value.

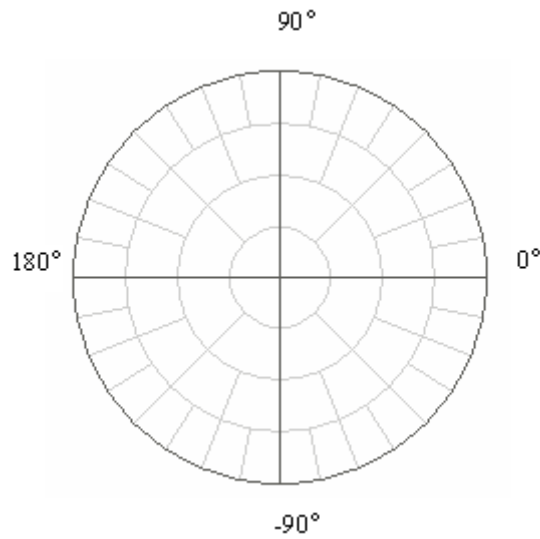

Figure 4.13 Polar format

The polar graph does not have a frequency axis, so frequency will be indicated by the markers. There are three types of polar formats depending on the data displayed by the marker. The traces will remain the same on all the graphs.

Table 4.12 Polar formats

Format Type Description	Label	Data Displayed by Marker	Measurement Unit (Y-axis)
Linear Magnitude and Phase	Polar (Lin)	S-parameter linear magnitude	Abstract number
		S-parameter phase	Degree (°)
Logarithmic Magnitude and Phase	Polar (Log)	S-parameter logarithmic magnitude	Decibel (dB)
		S-parameter phase	Degree (°)
Real and Imaginary Parts	Polar (Re/Im)	S-parameter real part	Abstract number
		S-parameter imaginary part	Abstract number

4.8.3 Smith Chart Format

Smith chart format is used for representation of impedance values for DUT reflection measurements. In this format, the trace has the same points as in polar format.

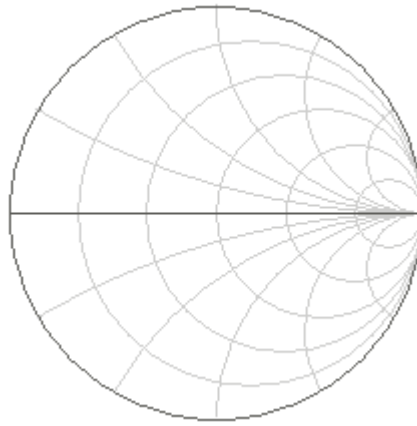

Figure 4.14 Smith chart format

The polar graph does not have a frequency axis, so frequency will be indicated by the markers. There are five types of Smith chart formats depending on the data displayed by the marker. The traces will remain the same on all the graphs.

Table 4.13 Smith chart formats

Format Type Description	Label	Data Displayed by Marker	Measurement Unit (Y-axis)
Linear Magnitude and Phase	Smith (Lin)	S-parameter linear magnitude	Abstract number
		S-parameter phase	Degree (°)
Logarithmic Magnitude and Phase	Smith (Log)	S-parameter logarithmic magnitude	Decibel (dB)
		S-parameter phase	Degree (°)
Real and Imaginary Parts	Smith (Re/Im)	S-parameter real part	Abstract number
		S-parameter imaginary part	Abstract number

Table 4.13 Smith chart formats (continued)

Complex Impedance (at Input)	Smith (R + jX)	Resistance at input: $R = re(Z_{inp})$, $Z_{inp} = Z_0 \frac{1+S}{1-S}$	Ohm (Ω)
		Reactance at input: $X = im(Z_{inp})$	Ohm (Ω)
		Equivalent capacitance or inductance: $C = -\frac{1}{\omega X}$, $X < 0$ $L = \frac{X}{\omega}$, $X > 0$	Farad (F) Henry (H)
Complex admittance (at Input)	Smith (G + jB)	Conductance at input: $G = re(Y_{inp})$, $Y_{inp} = \frac{1}{Z_0} \cdot \frac{1-S}{1+S}$	Siemens (S)
		Susceptance at input: $B = im(Y_{inp})$	Siemens (S)
		Equivalent capacitance or inductance: $C = \frac{B}{\omega}$, $B > 0$ $L = -\frac{1}{\omega B}$, $B < 0$	Farad (F) Henry (H)

Z_0 – test port impedance. Z_0 setting is described in section 5.2.12.

4.8.4 Data Format Setting

You can select the format for each trace of the channel individually. Before you set the format, first activate the trace.



To set the rectangular format, use the following softkey:

Format

Then select the required format:

- **Logarithmic magnitude**
- **SWR**
- **Phase**
- **Expanded phase**
- **Group delay**
- **Linear magnitude**
- **Real part**
- **Imaginary part**

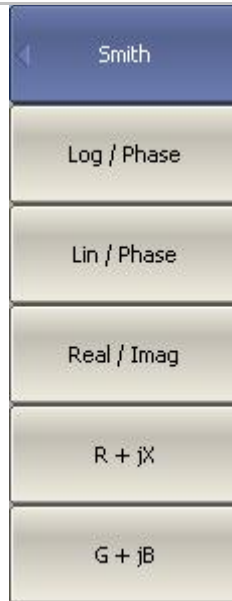

To set the Smith chart format, use the following softkeys:

Format > Smith

Then select the required format:

- **Logarithmic magnitude and phase**
- **Linear magnitude and phase**
- **Real and imaginary parts**
- **Complex impedance (at input)**
- **Complex admittance (at input)**

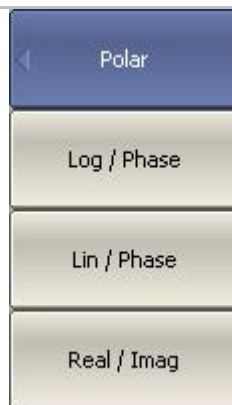

To set the Smith chart format, use the following softkeys:

Format > Polar

Then select the required format:

- **Logarithmic magnitude and phase**
- **Linear magnitude and phase**
- **Real and imaginary parts**

4.9 Scale Setting

4.9.1 Rectangular Scale

For rectangular format you can set the following parameters (See figure 4.15):

- Scale division;
- Reference level value;
- Reference level position;
- Number of scale divisions.

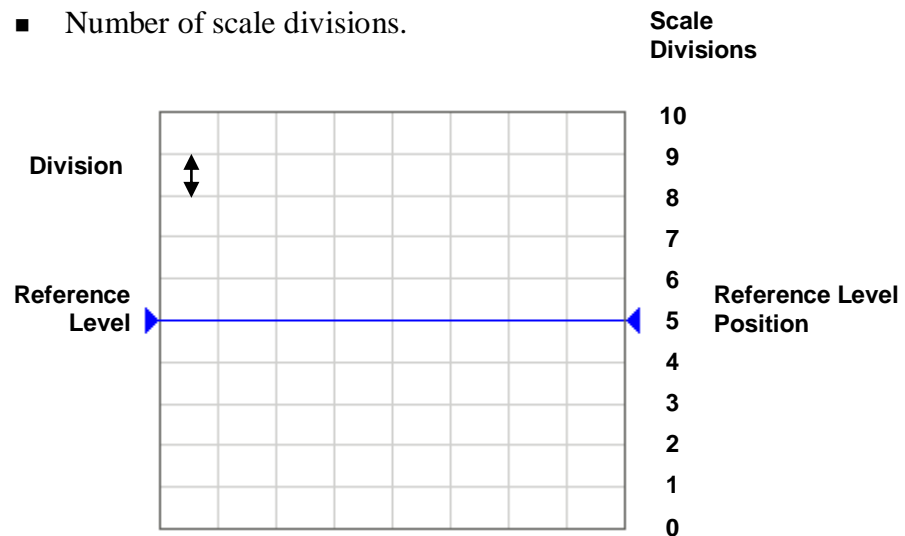
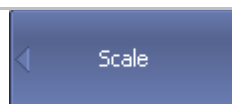

Figure 4.15 Rectangular scale

4.9.2 Rectangular Scale Setting

You can set the scale for each trace of a channel. Before you set the scale, first activate the trace.



To set the scale of a trace, use the following softkeys:

Scale > Scale

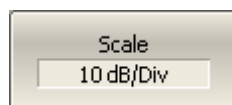

To set the reference level, use the following softkeys:

Scale > Ref Value

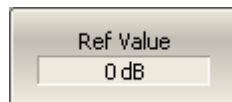

To set the position of the reference level, use the following softkeys:

Scale > Ref Position





To set the number of trace scale divisions, use the following softkeys:

Scale > Divisions¹

Note

Quick trace scale setting by the mouse is described in section 4.3.

4.9.3 Circular Scale

For polar and Smith chart formats, you can set the outer circle value (See figure 4.16).

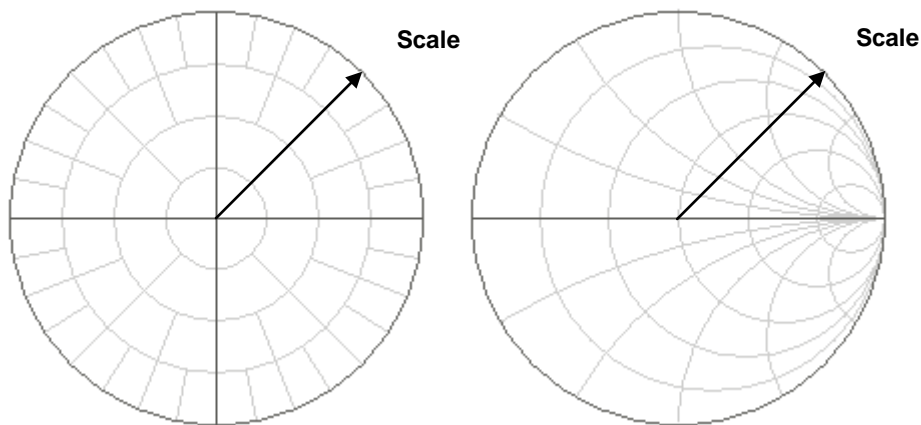

Figure 4.16 Circular scale

4.9.4 Circular Scale Setting



To set the scale of the circular graphs, use the following softkeys:

Scale > Scale

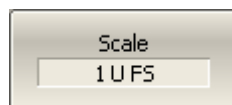



4.9.5 Automatic Scaling

The automatic scaling function automatically allows the user to define the trace scale so that the trace of the measured value could fit into the graph entirely.

In rectangular format, two parameters are adjustable: scale division and reference level position. In circular format, the outer circle value will be adjusted.



¹ Number of the scale divisions affect all the graphs of the channel.

	<p>To execute the automatic scaling, use the following softkeys:</p>
	<p>Scale > Auto Scale</p>

4.9.6 Reference Level Automatic Selection

This function executes automatic selection of the reference level in rectangular coordinates.

After the function has been executed, the trace of the measured value makes the vertical shift so that the reference level crosses the graph in the middle. The scale division will remain the same.

	<p>To execute the automatic selection of the reference level, use the following softkeys:</p>
	<p>Scale > Auto Ref Value</p>

4.9.7 Electrical Delay Setting

The electrical delay function allows the user to define the compensation value for the electrical delay of a device. This value is used as compensation for the electrical delay during non-linear phase measurements. The electrical delay is set in seconds.

If the electrical delay setting is other than zero, S-parameter value will vary in accordance with the following formula:

$$S = S \cdot e^{j \cdot 2\pi \cdot f \cdot t}, \quad \text{where}$$

f – frequency, Hz,

t – electrical delay, sec.

The electrical delay is set for each trace individually. Before you set the electrical delay, first activate the trace.

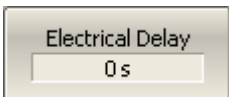
	<p>To set the electrical delay, use the following softkeys:</p>
	<p>Scale > Electrical Delay</p>

4.9.8 Phase Offset Setting

The phase offset function allows the user to define the constant phase offset of a trace. The value of the phase offset is set in degrees for each trace individually. Before you set the phase offset, first activate the trace.



To set the phase offset, use the following softkeys:

Scale > Phase Offset

4.10 Measurement Optimizing

You can set IF bandwidth, averaging and smoothing parameters in **Average** softkey submenu.

4.10.1 IF Bandwidth Setting

The IF bandwidth function allows the user to define the bandwidth of the test receiver. The IF bandwidth runs through the following sequence of numbers: 1, 1.5, 2, 3, 5, 7 within the range of 1 Hz to 30 kHz.

The IF bandwidth narrowing allows to reduce self-noise and widen the dynamic range of the Analyzer. Also the sweep time will increase. Narrowing of the IF bandwidth by 10 will reduce the receiver noise by 10 dB.

The IF bandwidth should be set for each channel individually. Before you set the IF bandwidth, first activate the channel.

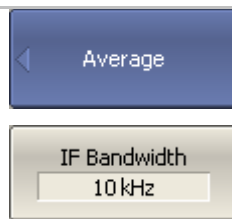

To set the IF bandwidth, use the following softkeys:

Average > IF Bandwidth

4.10.2 Averaging Setting

The averaging is performed in a measurement point is made over several previous sweeps. The averaging function is similar to IF bandwidth narrowing. It allows you to reduce self-noise and widen the dynamic measurement range of the Analyzer.

The averaging in each measurement point is made over several sweeps in accordance with the following equation:

$$\begin{cases} M_i = S_i, & i = 0 \\ M_i = \left(1 - \frac{1}{n}\right) \cdot M_{i-1} + \frac{S_i}{n}, & i > 0, \quad n = \min(i+1, N) \end{cases}$$

M_i – i -sweep averaging result;

S_i – i -sweep measurement parameter (S-parameter) value;

N – averaging factor is set by the user from 1 to 999; the higher the factor value the stronger the averaging effect.

When the averaging function is enabled, the current number of iterations and the averaging factor, e.g. «9/10», will appear in the channel status bar. The averaging process is considered stable when the both numbers have become equal.

The averaging should be set for each channel individually. Before you set the averaging, first activate the channel.

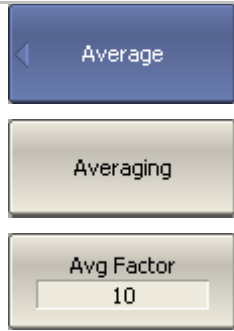
	<p>To toggle the averaging function on/off, use the following softkeys:</p> <p>Average > Averaging</p> <p>To set the averaging factor, use the following softkeys:</p> <p>Averaging > Avg Factor</p>
---	--

4.10.3 Smoothing Setting

The smoothing of the sweep results is made by averaging of adjacent points of the trace determined by the moving aperture. The aperture is set by the user in percent against the total number of the trace points.

The smoothing does not increase dynamic range of the Analyzer. It does not affect the average level of the trace, but it reduces the noise bursts.

The smoothing should be set for each trace individually. Before you set the smoothing, first activate the trace.

	<p>To toggle the smoothing function on/off, use the following softkeys:</p> <p>Averaging > Smoothing</p> <p>To set the smoothing aperture, use the following softkeys:</p> <p>Averaging > Smo Aperture</p>
---	--

4.11 Mixer Measurements

4.11.1 Mixer Measurement Methods

The Analyzer allows you to perform measurements of mixers and other frequency translating devices using scalar and vector methods.

The **scalar method** allows measurement of the scalar transmission S-parameters of frequency translating devices. Phase and group delay measurements are not accessible

in this mode. The advantage of this method is the simplicity of measurement setup (no additional equipment necessary). See Figure 4.17.

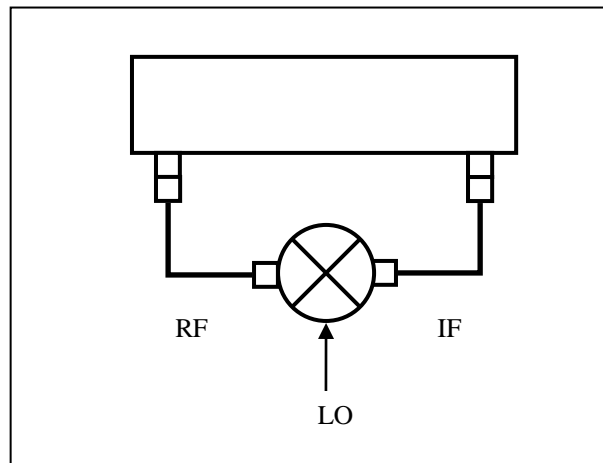

Figure 4.17 Scalar mixer measurement setup

The scalar measurement method is based on *frequency offset* mode. Frequency offset mode enables a frequency offset between the Analyzer test ports as described in detail in section 4.11.2. Frequency offset mode can be combined with various calibration methods.

When performing scalar measurements of a mixer, the most accurate method of calibration is *scalar mixer calibration* (See section 5.6).

An easier but less accurate method is using absolute measurements in combination with receiver calibration and power calibration (See sections 4.7.3, 5.4 and section 5.5). This method often results in transmission S-parameter ripples due to mixer input and output mismatch. This can be partially compensated by using matching attenuators of 3-10 dB at the mixer input and output.

The **vector mixer calibration method** allows for measurement of mixer transmission complex S-parameters including phase and group delay. The method requires additional equipment (See Figure 4.18): an external mixer with filter, which is called *calibration mixer*, and a LO common for both the calibration mixer and the mixer under test.

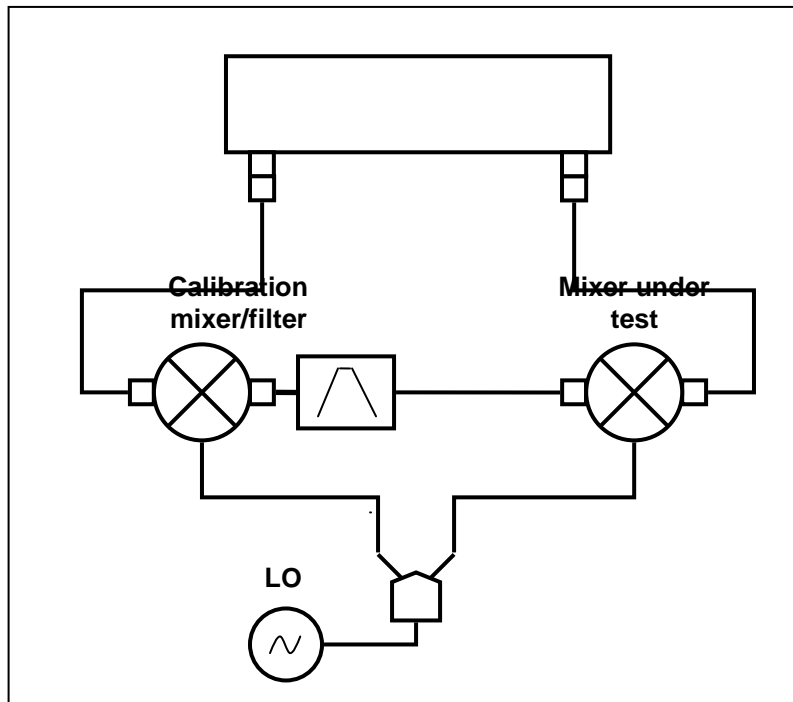

Figure 4.18 Vector mixer measurement setup

The vector mixer calibration method doesn't use frequency offset. The vector mixer calibration method ensures same frequency at the both test ports of the Analyzer, in normal operation mode. The vector mixer calibration procedure is described in the section 5.7.

4.11.2 Frequency Offset Mode

The Frequency Offset mode allows for S-parameter measurement of frequency translating devices including vector reflection measurements and scalar transmission measurements. In this context, frequency translating devices include both frequency shifting devices such as mixers and converters, as well as devices dividing or multiplying frequency.

This measurement mode is based on a frequency offset between the ports. The frequency offset is defined for each port using three coefficients: multiplier, divider, and offset. These coefficients allow for calculation of a port frequency relative to the *basic frequency range*.

$$F_{port} = \frac{M}{D} F_{base} + F_{ofs}$$

M – multiplier,

D – divider,

F_{ofs} – offset,

F_{base} – basic frequency.

In most cases it is sufficient to apply an offset to only one of the ports, leaving the other one at the basic frequency ($M=1$, $D=1$, $Fofs=0$).

Below are some examples of offset coefficient calculation for different types of frequency conversion. Here the mixer RF input is connected to Port 1, and the mixer IF output is connected to Port 2. The basic frequency range is set to the mixer RF frequency range and the first port of the Analyzer does not use frequency offset. The second port of the Analyzer is set to the IF frequency range and use frequency offset mode as follows:

1. $IF = RF - LO$	Port 2: $M = 1, D = 1, Fofs = -LO$.
2. $IF = LO - RF$	Port 2: $M = -1, D = 1, Fofs = LO$.
3. $IF = RF + LO$	Port 2: $M = 1, D = 1, Fofs = LO$.

In frequency offset mode, the bottom part of the channel window will indicate each port's frequency span (See Figure 4.19).

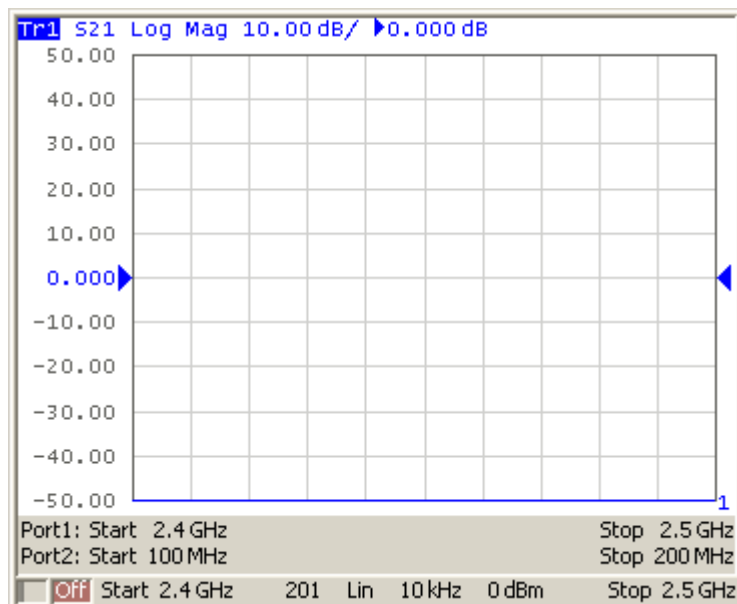

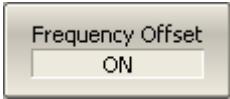
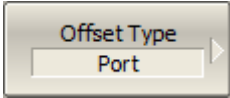

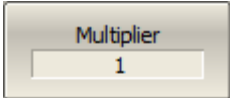
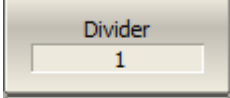
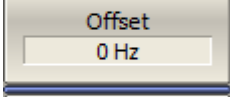
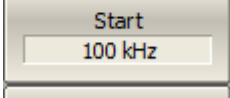
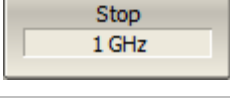

Figure 4.19 Channel window in frequency offset mode

User can set Start and Stop frequency for each port directly instead of using Multiplier, Divider and Offset values. Using Start/Stop values will set Multiplier and Offset, which can be determined from the specified frequency and the base frequency, while maintaining the preset Divider.

	<p>To enable/disable frequency offset mode, use the following softkeys:</p>
	<p>Stimulus > Frequency Offset > Frequency Offset</p>
	<p>The Offset Type must be set to Port.</p>
	<p>To enter offset coefficients for each Port, use the following softkeys:</p>
	<p>Stimulus > Frequency Offset > Port n > { Multiplier Divider Offset }</p>
	
	
	<p>Or set the port frequency range directly using the following softkeys:</p>
	<p>Stimulus > Frequency Offset > Port n > { Start Stop }</p>

4.11.3 Source/Receivers Frequency Offset Feature

Conventional frequency offset mode uses frequency offset between the ports, while the source and receivers of each port operate at a common frequency. Frequency offset between the ports allows for S-parameter measurement of frequency translating devices including vector reflection measurements and scalar transmission measurements.

The source/receivers frequency offset feature introduces a frequency offset between the source and receivers within a single port. Frequency offset between the source and receivers allows for absolute measurements only.

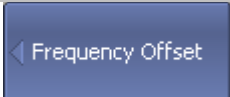
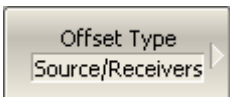
	<p>To enable source/receivers frequency offset feature, use the following softkeys:</p>
	<p>Stimulus > Frequency Offset > Offset Type > Source/Receivers</p>

4.11.4 Auxiliary Source

When you perform mixer measurements, you need an external LO signal source. The Auxiliary Source function allows for using one port as external LO signal source (See Figure 4.20).

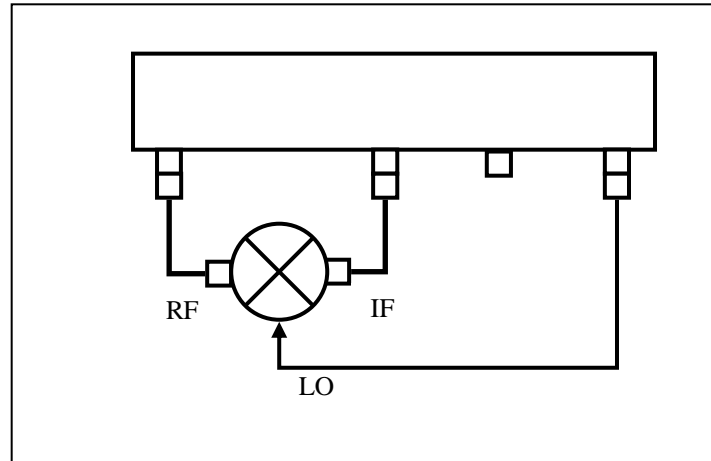

Figure 4.20 Auxiliary Source

Auxiliary source port outputs CW or swept signal independent on the frequency settings used for measurement. Auxiliary source power also can be set independent on the power setting used for measurement. Any port of Analyzer can be used as the auxiliary source. When Auxiliary Source function is active only two of the remaining ports can be used for measurement:

Port 1	Port 2	Port 3	Port 4
Auxiliary Source	Not available	Measurement	Measurement
Not available	Auxiliary Source	Measurement	Measurement
Measurement	Measurement	Auxiliary Source	Not available
Measurement	Measurement	Not available	Auxiliary Source

The auxiliary source frequency can be set using three coefficients: multiplier, divider, and offset relative to the *basic frequency range*.

$$F_{aux} = \frac{M}{D} F_{base} + F_{ofs}$$

M – multiplier,

D – divider,

F_{ofs} – offset,

F_{base} – basic frequency.

The auxiliary source frequency can be set directly using Start and Stop sweep values. Using Start/Stop values will set Multiplier and Offset, which can be determined from the specified frequency and the base frequency, while maintaining the preset Divider.

Setting equal Start and Stop values of auxiliary source allows to output CW signal.

  	<p>To enable/disable auxiliary source, use the following softkeys:</p> <p>Stimulus > Auxiliary Source > Auxiliary Source</p> <p>Select the auxiliary source port number using the following softkeys:</p> <p>Stimulus > Auxiliary Source > Select Port</p>
    	<p>To enter coefficients for auxiliary source, use the following softkeys:</p> <p>Stimulus > Auxiliary Source > { Multiplier Divider Offset }</p> <p>Or set the auxiliary source frequency range directly using the following softkeys:</p> <p>Stimulus > Auxiliary Source > { Start Stop }</p>
 	<p>To set the auxiliary source power, use the following softkeys:</p> <p>Stimulus > Auxiliary Source > Power</p>

5 CALIBRATION AND CALIBRATION KIT

5.1 General Information

5.1.1 Measurement Errors

S-parameter measurements are influenced by various measurement errors, which can be broken down into two categories:

- systematic errors, and
- random errors.

Random errors comprise such errors as noise fluctuations and thermal drift in electronic components, changes in the mechanical dimensions of cables and connectors subject to temperature drift, repeatability of connections and cable bends. Random errors are unpredictable and hence cannot be estimated and eliminated in calibration. Random errors can be reduced by correct setting of the source power, IF bandwidth narrowing, sweep averaging, maintaining constant environment temperature, observance of the Analyzer warm-up time, careful connector handling, and avoidance of cable bending after calibration.

Random errors and related methods of correction are not mentioned further in this section.

Systematic errors are the errors caused by imperfections in the components of the measurement system. Such errors occur repeatedly and their characteristics do not change with time. Systematic errors can be determined and then reduced by performing mathematical correction of the measurement results.

The process of measurement of precision devices with predefined parameters with the purpose of determination of measurement systematic errors is called **calibration**, and such precision devices are called **calibration standards**. The most commonly used calibration standards are SHORT, OPEN, and LOAD.

The process of mathematical compensation (numerical reduction) for measurement systematic errors is called an **error correction**.

5.1.2 Systematic Errors

The systematic measurement errors of vector network analyzers are subdivided into the following categories according to their source:

- Directivity;
- Source match;
- Load match;
- Isolation;
- Reflection/transmission tracking.

The measurement results before the procedure of error correction has been executed are called **uncorrected**.

The residual values of the measurement results after the procedure of error correction are called **effective**.

5.1.2.1 Directivity Error

A directivity error (**Ed**) is caused by incomplete separation of the incident signal from the reflected signal by the directional coupler in the source port. In this case part of the incident signal energy comes to the receiver of the reflected signal. Directivity errors do not depend on the characteristics of the DUT and usually have stronger effect in reflection measurements.

5.1.2.2 Source Match Error

A source match error (**Es**) is caused by the mismatch between the source port and the input of the DUT. In this case part of the signal reflected by the DUT reflects at the source port and again comes into the input of the DUT. The error occurs both in reflection measurement and in transmission measurement. Source match errors depend on the relation between input impedance of the DUT and test port impedance when switched as a signal source.

Source match errors have strong effect in measurements of a DUT with poor input matching.

5.1.2.3 Load Match Error

A load match error (**EI**) is caused by the mismatch between the receiver port and the output of the DUT. In this case part of the signal transmitted through the DUT reflects at the receiver port and comes to the output of the DUT. The error occurs in transmission measurements and in reflection measurements (for a 2-port DUT). Load match errors depend on the relation between output impedance of the DUT and test port impedance switched as a signal receiver.

In transmission measurements the load match error has considerable influence if the output of the DUT is poorly matched.

In reflection measurements the load match error has considerable influence in case of poor output match and low attenuation between the output and input of the DUT.

5.1.2.4 Isolation Error

An isolation error (**Ex**) is caused by a leakage of the signal from the source port to the receiver port escaping transmission through the DUT.

The Analyzer has typical isolation ratio of -140 dB, what allows to ignore this error for most of measurements. The isolation error measurement is a non-mandatory option in all types of calibration.

5.1.2.5 Reflection Tracking Error

A reflection tracking error (**Er**) is caused by the difference in frequency response between the test receiver and the reference receiver of the source port in reflection measurement.

5.1.2.6 Transmission Tracking Error

A transmission tracking error (**Et**) is caused by the difference in frequency response between the test receiver of the receiver port and the reference receiver of the source port in transmission measurement.

5.1.3 Error Modeling

Error modeling and method of signal flow graphs are applied to vector network analyzers for analysis of its systematic errors.

5.1.3.1 One-Port Error Model

In reflection measurement only one port of the Analyzer is used. The signal flow graph of errors for the port 1 is represented in figure 5.1. For other ports the signal flow graph of the errors will be similar.

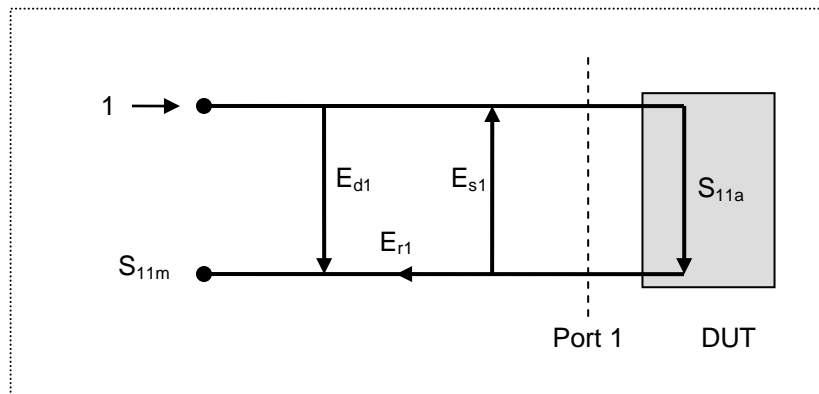

Figure 5.1 One-port error model

Where:

- S_{11a} – reflection coefficient true value;
- S_{11m} – reflection coefficient measured value.

The measurement result at port 1 is affected by the following three systematic error terms:

- E_{d1} – directivity;
- E_{s1} – source match;
- E_{r1} – reflection tracking.

For normalization the stimulus value is taken equal to 1. All the values used in the model are complex.

After determining all the three error terms E_{d1} , E_{s1} , E_{r1} for each measurement frequency by means of a **full 1-port calibration**, it is possible to calculate (mathematically subtract the errors from the measured value S_{11m}) the true value of the reflection coefficient S_{11a} .

There are simplified calibration methods, which eliminate the effect of only one or two out of the three systematic errors. These methods are **Response Open** and **Response Short** calibrations.

5.1.3.2 Two-Port Error Model

For a two-port measurement, two signal flow graphs are considered. One of the graphs describes the case where port 1 is the stimulus source, the other graph describes the case where port 2 is the stimulus source.

Note The signal flow graph below represents ports 1 and 2. For other port pairs the signal flow graph of errors will be similar.

The signal flow graphs of error impact in a two-port system are represented in figure 5.2.

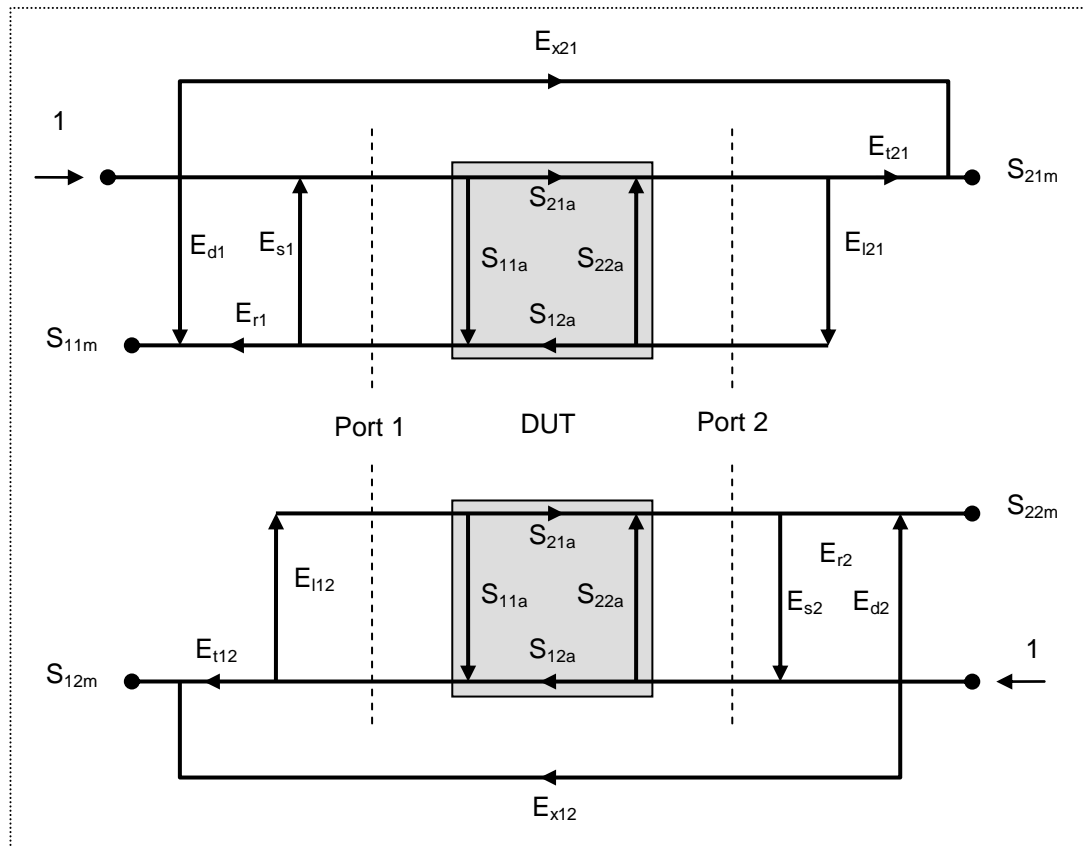

Figure 5.2 Two-port error model

Where:

- S_{11a} , S_{21a} , S_{12a} , S_{22a} – true values of the DUT parameters;
- S_{11m} , S_{21m} , S_{12m} , S_{22m} – measured values of the DUT parameters.

For normalization the stimulus value is taken equal to 1. All the values used in the model are complex.

The measurement result in a two-port system is affected by twelve systematic error terms.

Table 5.1 Systematic error terms in a two-port system

Description	Stimulus Source	
	Port 1	Port 2
Directivity	E_{d1}	E_{d2}
Source match	E_{s1}	E_{s2}
Reflection tracking	E_{r1}	E_{r2}
Transmission tracking	E_{t21}	E_{t12}
Load match	E_{l21}	E_{l12}
Isolation	E_{x21}	E_{x12}

After determination of all the twelve error terms for each measurement frequency by means of a **2-port SOLT or TRL calibration**, it is possible to calculate the true value of the S-parameters: S_{11a} , S_{21a} , S_{12a} , S_{22a} .

There are simplified methods, which eliminate the effect of only one or several out of the twelve systematic error terms. These methods are **Response Thru** and **One Path 2-Port** calibrations.

Note

If you use a 2-port calibration, to determine any of S-parameters you need to know all the four measurements S_{11m} , S_{21m} , S_{12m} , S_{22m} . That is why to update one or all of the S-parameters, you need to perform two sweeps: with port 1 as a signal source, and with port 2 as a signal source or forward and reverse directions.

5.1.3.3 Three-Port Error Model

A measurement result in a three-port system is affected by twenty seven systematic error terms. It is shown in the table 5.2.

Note	The systematic error terms are shown for ports 1, 2 and 3. For other port triplets the systematic error terms will be similar.
------	--

Table 5.2 Systematic error terms in a three-port system

Description	Stimulus Source		
	Port 1	Port 2	Port 3
Directivity	\mathbf{E}_{d1}	\mathbf{E}_{d2}	\mathbf{E}_{d3}
Source match	\mathbf{E}_{s1}	\mathbf{E}_{s2}	\mathbf{E}_{s3}
Reflection tracking	\mathbf{E}_{r1}	\mathbf{E}_{r2}	\mathbf{E}_{r3}
Transmission tracking	$\mathbf{E}_{t21}, \mathbf{E}_{t31}$	$\mathbf{E}_{t12}, \mathbf{E}_{t32}$	$\mathbf{E}_{t13}, \mathbf{E}_{t23}$
Load match	$\mathbf{E}_{l21}, \mathbf{E}_{l31}$	$\mathbf{E}_{l12}, \mathbf{E}_{l32}$	$\mathbf{E}_{l13}, \mathbf{E}_{l23}$
Isolation	$\mathbf{E}_{x21}, \mathbf{E}_{x31}$	$\mathbf{E}_{x12}, \mathbf{E}_{x32}$	$\mathbf{E}_{x13}, \mathbf{E}_{x23}$

After determination of all the twenty seven error terms for each measurement frequency by means of a **3-port SOLT or TRL calibration**, it is possible to calculate the true value of the S-parameters: $S_{11a}, S_{21a}, \dots S_{33a}$.

Note	If you use a 3-port calibration, to determine any of S-parameters you need to know all the nine measurements $S_{11m}, S_{21m}, \dots S_{33m}$. That is why to update one or all of the S-parameters, you need to perform three sweeps: with each port as a signal source.
------	---

5.1.3.4 Four-Port Error Model

A measurement result in a four-port system is affected by forty eight systematic error terms. It is shown in the table 5.3.

Table 5.3 Systematic error terms in a four-port system

Description	Stimulus Source			
	Port 1	Port 2	Port 3	Port 4
Directivity	\mathbf{E}_{d1}	\mathbf{E}_{d2}	\mathbf{E}_{d3}	\mathbf{E}_{d4}
Source match	\mathbf{E}_{s1}	\mathbf{E}_{s2}	\mathbf{E}_{s3}	\mathbf{E}_{s4}
Reflection tracking	\mathbf{E}_{r1}	\mathbf{E}_{r2}	\mathbf{E}_{r3}	\mathbf{E}_{r4}
Transmission tracking	$\mathbf{E}_{t21}, \mathbf{E}_{t31}, \mathbf{E}_{t41}$	$\mathbf{E}_{t12}, \mathbf{E}_{t32}, \mathbf{E}_{t42}$	$\mathbf{E}_{t13}, \mathbf{E}_{t23}, \mathbf{E}_{t43}$	$\mathbf{E}_{t14}, \mathbf{E}_{t24}, \mathbf{E}_{t34}$
Load match	$\mathbf{E}_{l21}, \mathbf{E}_{l31}, \mathbf{E}_{l41}$	$\mathbf{E}_{l12}, \mathbf{E}_{l32}, \mathbf{E}_{l42}$	$\mathbf{E}_{l13}, \mathbf{E}_{l23}, \mathbf{E}_{l43}$	$\mathbf{E}_{l14}, \mathbf{E}_{l24}, \mathbf{E}_{l34}$
Isolation	$\mathbf{E}_{x21}, \mathbf{E}_{x31}, \mathbf{E}_{x41}$	$\mathbf{E}_{x12}, \mathbf{E}_{x32}, \mathbf{E}_{x42}$	$\mathbf{E}_{x13}, \mathbf{E}_{x23}, \mathbf{E}_{x43}$	$\mathbf{E}_{x14}, \mathbf{E}_{x24}, \mathbf{E}_{x34}$

After determination of all the forty eight error terms for each measurement frequency by means of a **4-port SOLT or TRL calibration**, it is possible to calculate the true value of the S-parameters: $S_{11a}, S_{21a}, \dots S_{44a}$.

Note	If you use a 4-port calibration, to determine any of S-parameters you need to know all the nine measurements $S_{11m}, S_{21m}, \dots S_{44m}$. That is why to update one or all of the S-parameters, you need to perform four sweeps: with each port as a signal source.
------	--

5.1.4 Analyzer Test Ports Defining

The test ports of the Analyzer are defined by means of calibration. The test port is a connector accepting a calibration standard in the process of calibration.

A type-N 50 Ω connector on the front panel of the Analyzer will be the test port if the calibration standards are connected directly to it.

Often it is necessary to connect cables to the connector on the front panel and adapters for connection of the DUT with a different connector type. In such cases connect calibration standards to the connector of the cable or adapter.

Figure 5.3 represents two cases of test port defining for 2-port measurement. The use of cables and/or adapters does not affect the measurement results if they were integrated into the process of calibration.

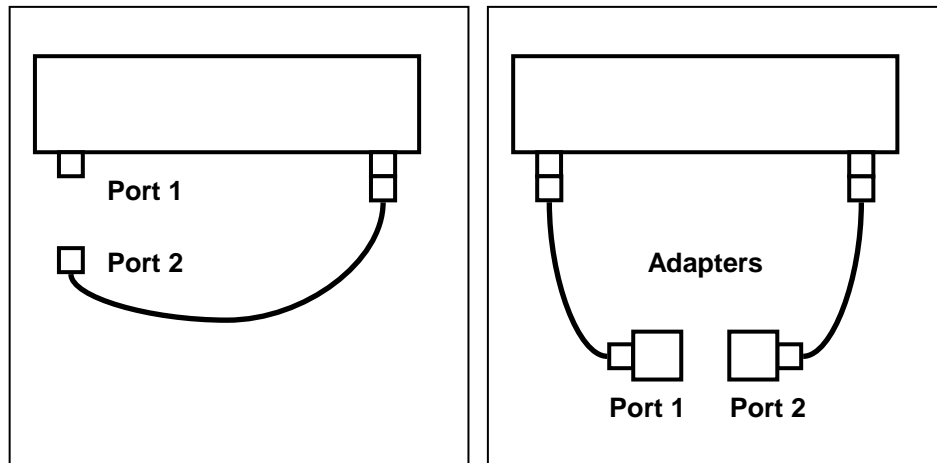

Figure 5.3 Test port defining

In some cases, the term of *calibration plane* is used. Calibration plane is an imaginary plane located at the ends of the connectors, which accept calibration standards during calibration.

5.1.5 Calibration Steps

The process of calibration comprises the following steps:

- Selection of the calibration kit matching the connector type of the test port. The calibration kit includes such standards as SHORT, OPEN, and LOAD with matched impedance. Magnitude and phase responses i.e. S-parameters of the standards are well known. The characteristics of the standards are represented in the form of an **equivalent circuit model**, as described below;
- Selection of a calibration method (see section 5.1.6) is based on the required accuracy of measurements. The calibration method determines what error terms of the model (or all of them) will be compensated;
- Measurement of the standards within a specified frequency range. The number of the measurements depends on the type of calibration;
- The Analyzer compares the measured parameters of the standards against their predefined values. The difference is used for calculation of the calibration coefficients (systematic errors);
- The table of calibration coefficients is saved into the memory of the Analyzer and used for error correction of the measured results of any DUT.

Calibration is always made for a specific channel, as it depends on the channel stimulus settings, particularly on the frequency span. This means that a table of calibration coefficients is being stored each for an individual channel.

5.1.6 Calibration Methods

The Analyzer supports several methods of one-port and two-port calibrations. The calibration methods vary by quantity and type of the standards being used, by type of error correction, and accuracy. The table below represents the overview of the calibration methods.

Note	To simplify the table, the S-parameter and error terms indexes are given with the smallest numbers. Other ports will bear similar indexation. For example, if in the Transmission Normalization row we have test ports 3-4 instead of 1-2, the indexation will be S_{43} , E_{t43} , E_{x43} instead of S_{21} , E_{t21} , E_{x21} .
------	--

Table 5.2 Calibration methods

Calibration Method	Parameters	Standards	Error Terms	Accuracy
Reflection Normalization	S_{11}	<ul style="list-style-type: none"> ▪ SHORT or OPEN ▪ LOAD ¹ 	E_{r1}, E_{d1} ¹	Low
Transmission Normalization	S_{21}	<ul style="list-style-type: none"> ▪ THRU ▪ 2 LOADs² 	E_{t21}, E_{x21} ²	Low
Full One-Port Calibration	S_{11}	<ul style="list-style-type: none"> ▪ SHORT ▪ OPEN ▪ LOAD 	E_{r1}, E_{d1}, E_{s1}	High
One-Path Two-Port Calibration	S_{11}, S_{21}	<ul style="list-style-type: none"> ▪ SHORT ▪ OPEN ▪ LOAD ▪ THRU ▪ 2 LOADs² 	$E_{r1}, E_{d1}, E_{s1}, E_{t21}, E_{x21}$ ²	Medium
Full 2-Port Calibration	S_{11}, S_{21} S_{12}, S_{22}	<ul style="list-style-type: none"> ▪ SHORT ▪ OPEN ▪ LOAD ▪ THRU ▪ 2 LOADs² 	Twelve error terms (table 5.1)	High
Full 3-Port Calibration	S_{11}, S_{21}, S_{31} S_{12}, S_{22}, S_{32} S_{13}, S_{23}, S_{33}	<ul style="list-style-type: none"> ▪ SHORT ▪ OPEN ▪ LOAD ▪ THRU ▪ 2 LOADs² 	twenty seven error terms (table 5.2)	High
Full 4-Port Calibration	All 16 S-parameters	<ul style="list-style-type: none"> ▪ SHORT ▪ OPEN ▪ LOAD ▪ THRU ▪ 2 LOADs² 	forty eight error terms (table 5.3)	High

¹ If optional directivity calibration is performed.

² If optional isolation calibration is performed.

Table 5.2 Calibration methods (continued)

2-Port Calibration	TRL S_{11}, S_{21} S_{12}, S_{22}	<ul style="list-style-type: none"> ▪ THRU or LINE ▪ REFLECT ▪ LINE or 2 LOADs 	$E_{r1}, E_{d1}, E_{s1}, E_{t21},$ E_{l21} $E_{r2}, E_{d2}, E_{s2}, E_{t12},$ E_{l12}	Very High
3-Port Calibration	TRL S_{11}, S_{21}, S_{31} S_{12}, S_{22}, S_{32} S_{13}, S_{23}, S_{33}	<ul style="list-style-type: none"> ▪ THRU or LINE ▪ REFLECT ▪ LINE or 2 LOADs 	The same as full 3-port calibration except for isolation terms	Very High
4-Port Calibration	TRL All 16 S- parameters	<ul style="list-style-type: none"> ▪ THRU or LINE ▪ REFLECT ▪ LINE or 2 LOADs 	The same as full 4-port calibration except for isolation terms	Very High

5.1.6.1 Normalization

Normalization is the simplest method of calibration as it involves measurement of only one calibration standard for each S-parameter.

- 1-port reflection measurements (S_{11} , for example) are calibrated by means of a SHORT or an OPEN standard, estimating reflection tracking error term **Er**.
- 2-port transmission measurements (S_{21} , for example) are calibrated by means of a THRU standard, estimating transmission tracking error term **Et**.

This method is called normalization because the measured S-parameter at each frequency point is divided (normalized) by the corresponding S-parameter of the calibration standard.

Normalization eliminates frequency-dependent attenuation and phase offset in the measurement circuit, but does not compensate for errors of directivity, mismatch or isolation. This constrains the accuracy of the method.

Note	Normalization can also be referred to as response open , response short or response thru calibration depending on the standard being used: an OPEN, SHORT or THRU respectively.
------	--

5.1.6.2 Directivity Calibration (Optional)

The Analyzer offers optional directivity (**Ed**) calibration feature, which can be used in combination with reflection normalization by means of additional measurement of a LOAD standard. Auxiliary directivity correction increases the accuracy of normalization.

5.1.6.3 Isolation Calibration (Optional)

The Analyzer offers optional isolation (**Ex**) calibration to be combined with the following three methods of calibration:

- transmission normalization,
- one-path two-port calibration,
- full 2/3/4-port calibration.

This calibration is performed by isolation measurement using LOAD standards connected to the both test ports of the Analyzer. Isolation calibration can be omitted in most of tests as the signal leakage between the test ports of the Analyzer is negligible.

Note	For isolation calibration, it is recommended to set narrow IF bandwidth, attenuation, and firmly fix the cables.
------	--

5.1.6.4 Full One-Port Calibration

Full one-port calibration involves connection of the following three standards to one test port:

- SHORT,
- OPEN,
- LOAD.

Measurement of the three standards allows for acquisition of all the three error terms (**Ed, Es, and Er**) of a one-port model. Full 1-port calibration is a highly accurate method for 1-port reflection measurements.

5.1.6.5 One-Path Two-Port Calibration

A one-path two-port calibration combines full one-port calibration with transmission normalization. This method allows for a more accurate estimation of transmission tracking error (**Et**) than using transmission normalization.

One-path two-port calibration involves connection of the three standards to the source port of the Analyzer (as for one-port calibration) and a THRU standard connection between the calibrated source port and the other receiver port.

One-path two-port calibration allows for correction of **Ed**, **Es**, and **Er** error terms of the source port and a transmission tracking error term (**Et**). This method does not derive source match error term (**EI**) of a 2-port error model.

One-path two-port calibration is used for measurements of the parameters of a DUT in one direction, S_{11} and S_{21} for example.

5.1.6.6 Full Two-Port Calibration

A full two-port calibration involves seven connections of the standards. This calibration combines two full 1-port calibrations for each port, and one THRU connection, which provides two transmission measurements for each test port being a source. If optional isolation calibration is required, connect LOAD standards to the both test ports of the Analyzer and perform two isolation measurements for each source port.

Full 2-port calibration allows for correction of all the twelve error terms of a 2-port error model: **E_{d1}**, **E_{d2}**, **E_{s1}**, **E_{s2}**, **E_{r1}**, **E_{r2}**, **E_{t12}**, **E_{t21}**, **E_{l12}**, **E_{l21}**, **E_{x12}**, **E_{x21}** (correction of **E_{x12}**, **E_{x21}** can be omitted).

Full 2-port calibration is a highly accurate method of calibration for 2-port DUT measurements.

5.1.6.7 Full 3-Port Calibration

A full 3-port calibration involves twelve connections of the standards. This calibration combines three full 1-port calibrations for each port, and THRU connections for each test port pair, which provides three transmission measurements. If optional isolation calibration is required, connect LOAD standards to the each test port pair of the Analyzer and perform three isolation measurements.

Full 3-port calibration allows for correction of all the twenty seven error terms (table 5.2) of a 3-port error model (acquisition of isolation terms can be omitted).

Full 3-port calibration is a highly accurate method of calibration for 3-port DUT measurements.

5.1.6.8 Full 4-Port Calibration

A full 4-port calibration involves eighteen connections of the standards. This calibration combines four full 1-port calibrations for each port, and THRU connections for each test port pair, which provides six transmission measurements. If optional isolation calibration is required, connect LOAD standards to the each test port pair of the Analyzer and perform six isolation measurements.

Full 4-port calibration allows for correction of all the forty eight error terms (table 5.3) of a 4-port error model (acquisition of isolation terms can be omitted).

Full 4-port calibration is a highly accurate method of calibration for 4-port DUT measurements.

5.1.6.9 Simplified Full 3/4-Port Calibration

Part of THRU measurements can be omitted in the full 3/4-port calibration.

In the simplified 3-port calibration, 1 out of 3 measurements of THRU is omitted. Any of the measurements can be omitted. For example, if the port numbers of a 3-port calibration are 1-2-3, 1-2 or 1-3 or 2-3 measurements can be omitted.

In the simplified 4-port calibration, up to 3 out of 6 measurements of THRU are omitted. However, if the topology is other than star (with one common port), it is recommended to perform a fourth measurement to enhance the calibration accuracy.

Example 1: 3 out of 6 THRU measurements have been performed, the topology of THRU connection is star, for example 1-2, 1-3, 1-4. The simplified calibration can be finished.

Example 2: 3 out of 6 THRU measurements have been performed, the topology of THRU connection is not star, for example 1-2, 2-3, 3-4. The simplified calibration can be finished, however to enhance accuracy it is recommended to perform one more (any) THRU measurement.

Note

Unlike in the calibration using full set of calibration standards, in the simplified calibration the quality of measurements is more critical. Observe the following instructions:

- Use calibration standards with good stability and repeatability;
 - Make sure the standard model is defined correctly: do not omit the THRU definition if it is not a zero-length THRU (not flush THRU);
 - Use quality cables with small phase/amplitude change on bends;
 - Use precision connectors.
-

5.1.6.10 Sliding Load Calibration

In full one-port and full two-port calibrations it is possible to employ a SLIDING LOAD calibration standard instead of a fixed one. The use of the SLIDING LOAD standard allows for significant increase in calibration accuracy at high frequencies compared to the FIXED LOAD standard.

The sliding load calibration involves a series of measurements in different positions of the sliding element to compensate for reflection from the dissipation component.

To activate the sliding load calibration algorithm, the selected calibration kit should contain the calibration standard of sliding load type, and it should be assigned "load" *class* of the corresponding port. Calibration standard editing and class assignment are further described in detail.

The sliding load calibration is not applied at lower frequencies. To eliminate this limitation, use a FIXED LOAD standard in the lower part of the frequency range. For combined calibration with SLIDING and FIXED LOADS, use the procedure of standard *subclasses* assigning. This procedure is described in detail below.

5.1.6.11 Unknown Thru Calibration

An UNKNOWN THRU calibration standard is used in full 2/3/4-port calibration, which is also known as SOLT (Short, Open, Load, Thru) calibration.

This calibration method involves connecting the test ports to each other, what is called THRU. If the connectors' gender or type prevent direct connection, a DEFINED THRU is used. But it is not always possible to know the exact parameters of the THRU, in this case UNKNOWN THRU calibration is used.

An arbitrary two-port device with unknown parameters can be used as an UNKNOWN THRU. An UNKNOWN THRU should satisfy only two requirements.

The first requirement applies to the transmission coefficient of the THRU. It should satisfy the reciprocity condition ($S_{21} = S_{12}$), which holds for almost any passive network. Besides, it is not recommended to use a THRU with the loss higher than 20 dB as it can reduce the calibration accuracy.

The second requirement is to know the approximate electrical length of the UNKNOWN THRU within the accuracy of 1/4 of the wavelength at the maximum calibration frequency. This requirement, however, can be omitted if the following frequency increment is selected:

$$\Delta F < \frac{1}{4 \cdot \tau_0}, \text{ where } \tau_0 - \text{delay of a two-port device.}$$

In this case the Analyzer program automatically determines the electrical length (delay) of the two-port device.

In other words, you can perform the calibration without setting the delay of the UNKNOWN THRU if the frequency increment is small enough. For example, for UNKNOWN THRU with $l_0 \approx 100\text{mm}$ and delay coefficient $1/\sqrt{\epsilon} \approx 0.7$, the delay will be $\tau_0 \approx 477\text{ps}$. In this case the frequency increment for automatic defining of the UNKNOWN THRU delay should be set to $\Delta F < 524\text{MHz}$, or the number of points within the sweep span of 8 GHz should be no less than 16. To ensure reliable operation, set the frequency increment and the number of points with double margin at least.

To be able to use the unknown thru calibration algorithm in full two-port calibration, the calibration kit definition should include the UNKNOWN THRU standard, assigned to the THRU class for the two ports. The procedure of calibration standards editing and their assignment to classes is further described in detail.

An UNKNOWN THRU is defined automatically, if you set the delay to zero in the calibration kit editing menu. Otherwise the user-defined delay value will be used. This value should be set within the accuracy of 1/4 of the wavelength at the maximum calibration frequency.

5.1.6.12 TRL Calibration

TRL (Thru-Reflect-Line) calibration is the most accurate calibration method described herein, as it uses airlines as calibration standards. The TRL calibration requires the use of the following calibration standards:

- THRU or REFERENCE LINE,
- REFLECT (SHORT or OPEN),
- Second LINE or two MATCHes.

TRL is a general name for a calibration family, which comprises such calibrations as LRL, TRM, or LRM named depending on the calibration standards used.

If a zero-length THRU is used as the first standard, the method is called TRL calibration. If a non-zero length LINE is used as the first standard, the calibration method is called LRL (Line-Reflect-Line). To denote the first standard of the TRL and LRL calibration, assign *TRL-Thru* class, which includes THRU and LINES. A LINE of *TRL-Thru* class is also called *Reference Line*.

An OPEN or SHORT is usually used as a second standard in TRL calibration. To denote the second standard of the TRL calibration, assign *TRL-Reflect* class.

A second LINE is used as the third standard in TRL calibration. At low frequencies, at which MATCHes work well, two MATCHes can be used, as they are an equivalent of a matched line of infinite length. In the latter case, the calibration method is called TRM (Thru-Reflect-Match) or LRM (Line-Reflect-Match) respectively. To denote the third standard of the TRL calibration, assign *TRL-line/match* class, which includes LINES and MATCHes.

Frequency Range

TRL and LRL calibrations have a limited bandwidth with lower to upper frequency ratio up to 1:8. The band limits depend on the LINE length in TRL calibration or on the difference between the lengths of the two LINES in LRL calibration.

In theory TRM and LRM calibrations do not have limitations by frequency, however their use at higher frequencies is limited by the quality of the MATCHes. It is recommended to use the TRM and LRM calibrations up to 1 GHz.

Impedance of LINES and MATCHes

All the LINES and MATCHes used for TRL calibration must have Z_0 impedance values as precise as possible. TRL calibration transfers the impedance of standards into the calibrated system. Precise airlines with an accurate Z_0 impedance of 50Ω are used as LINES in coaxial paths.

REFERENCE LINE

A zero-length THRU is used as the first standard in TRL calibration. In LRL calibration a LINE, which is called REFERENCE LINE, is used instead of a zero-length THRU. The shortest LINE is used as the REFERENCE LINE. Its length must to be known, so that the calibration plane positions could be calculated exactly. However, LRL calibration is also possible when the REFERENCE LINE length is not known. In this case, its length is assumed to be equal to zero, the calibration plane being in the middle of the LINE, and not at the ports' edges.

TRL LINE

TRL LINE is an airline used in TRL calibration, or the second longest LINE used in LRL calibration. The length of TRL LINE should be known just approximately. The LINE length is used to determine the calibration bandwidth. Let ΔL be the difference between the two LINES in LRL calibration. In TRL calibration this difference will be equal to the LINE length, as a zero-length THRU is used as a REFERENCE LINE. Then the phase difference between the TRL LINE and REFERENCE LINE or THRU should be no less than 20° at the lower frequency and no more than 160° at the upper frequency of the calibration.

$$20 < \frac{360 \cdot f \cdot \Delta L}{v} < 160,$$

$$\Delta L = L_1 - L_0,$$

L_0 – REFERENCE LINE length,

L_1 – TRL LINE length,

v – wave velocity in LINE (for airline it is $c = 2.9979 \cdot 10^8$ m/c).

So, the useful frequency range for TRL/LRL calibration is 1:8. Besides, TRL/LRL calibration does not work at low frequencies, as it would require a very long LINE. Two or more TRL LINES are used to extend the calibration frequency. For example, in case of using two TRL LINES the frequency range can be increased up to 1:64.

TRL MATCH

Unlike TRL/LRL calibration, TRM/LRM calibration uses MATCHes, which are the equivalent to the infinitely long LINE, instead of a TRL LINE. Theoretically TRM/LRM calibration has no frequency limitations. However, the use of TRM/LRM calibration at higher frequencies is limited by the quality of the MATCHes. As a rule, the TRM/LRM calibration is used at lower frequencies, as it is good starting from zero frequency.

TRL REFLECT

There are no strict requirements to the TRL REFLECT standard. You should know only approximate parameters of the TRL REFLECT standard. The REFLECT standard should have high reflection coefficient, close to 1. The phase of the standard must be known within $\pm 90^\circ$. Normally, any OPEN or SHORT meets this requirement. The next requirement is that the reflection coefficient must be the same for all the ports. If one standard is used for all the ports by turns, then this requirement is automatically fulfilled. If the ports have different genders or types of connectors, use special standards with the identical electrical specifications, which are available in pairs.

TRL Calibration Frequency Extension

To extend the frequency of TRL calibration a method of dividing into several non-overlapping bands is applied. For each frequency band a separate TRL LINE of different length is used. The phase difference between each TRL LINE and the REFERENCE LINE must be from 20° to 160° , as indicated above. A MATCH standard is used in the lowest frequency band.

The Analyzer software allows using up to 8 LINES for calibration frequency extension. To achieve this, there are two steps of handling the calibration kits:

- defining frequency limits to calibration standards (see section 5.3.2);
- assigning classes to calibration standards, where up to 8 calibration standards can be assigned to one class (see section 5.3.4).

Perform the above mentioned dividing of the calibration band into sub-bands and assign a separate TRL LINE to each of them in the calibration kit editing menu before calibration.

5.1.6.13 Multiline TRL Calibration

Regular TRL calibration, described in the previous section uses several LINES of different lengths for frequency extension. It is provided by the method of dividing the frequency band into separate sub-bands.

Multiline TRL calibration also uses several LINES. But it does not divide the frequency band into several sub-bands. Instead, all the LINES are used simultaneously over the whole calibration bandwidth. The redundancy of the LINES measurements allows for both extending the frequency range and increasing the calibration accuracy. The number of LINES should be no less than three. The more LINES you use, the higher the accuracy you will achieve.

To employ multiple LINES in the calibration procedure, use the same method of standards subclasses assignment as in the regular TRL calibration (see section 5.3.4). Defining frequency limits to calibration standards is not necessary for Multiline TRL calibration method.

The procedure of switching between the normal and Multiline TRL calibrations see in section 5.2.7.1.

The following table shows the differences between the regular and Multiline TRL calibrations when entering the data into the calibration standards editing menu.

Calibration Standard	Data in Calibration Kit Manager	
	TRL	Multiline TRL
REFERENCE LINE or THRU	1. Type: THRU/LINE 2. Min and max frequency 3. Delay* 4. Class: TRL THRU	1. Type: THRU/LINE 2. Delay* 3. Class: TRL LINE/MATCH or TRL THRU
LINE	1. Type: THRU/LINE 2. Min and max frequency 3. Class: TRL LINE/MATCH	The total number of LINEs is no less than 3.
MATCH (optional)	1. Type: MATCH 2. Min and max frequency 3. Class: TRL LINE/MATCH	1. Type: MATCH 2. Class: TRL LINE/MATCH
REFLECT	1. Type: SHORT or OPEN 2. Min and max frequency 3. Model parameters, which allow calculating value of phase response within $\pm 90^\circ$. 4. Class: TRL REFLECT	

* The delay for coaxial airlines is equal to $\frac{L}{v}$, where L is the length of the LINE, and v is the wave velocity in LINE equal to $2.9979 \cdot 10^8$ m/s.

5.1.7 Calibration Standards and Calibration Kits

Calibration standards are precision physical devices used for determination of errors in a measurement system.

A calibration kit is a set of calibration standards with a specific connector type and specific impedance.

The Analyzer provides definitions of calibration kits produced by different manufacturers. The user can add the definitions of own calibration kits or modify the predefined kits. Calibration kits editing procedure is described in the section 5.3.

To ensure the required calibration accuracy, select the calibration kit being used in the program menu. The procedure of calibration kit selection is described in section 5.2.1.

5.1.7.1 Definitions and Classes of Calibration Standards

Each calibration standard has a *definition* and belongs to one or several *classes*.

Calibration standard definition is a mathematical description of its parameters.

Calibration standard class is an application of the standard in a specific calibration method associated with a specific test port number. For example, "LOAD of port 1".

5.1.7.2 Types of Calibration Standards

Calibration standard type is a category of physical devices used to define the parameters of the standard. The Analyzer supports the following types of the calibration standards:

- OPEN,
- SHORT,
- FIXED LOAD,
- SLIDING LOAD,
- THRU/LINE,
- UNKNOWN TRHU,
- standard defined by data (S-parameters).

Note

The type of a calibration standard should not be confused with its class. Calibration standard type is a part of the standard definition used for the calculation of its parameters.

5.1.7.3 Methods of Calibration Standard Defining

The Analyzer provides two methods of defining a calibration standard:

- calibration standard model (See section 5.1.7.4),
- table of S-parameters (See section 5.1.7.5).

The calibration standards defined by the table of S-parameters are called *Data-Based standards*.

Besides, each calibration standard is characterized by lower and upper values of the operating frequency. In the process of calibration, the measurements of the calibration standards outside the specified frequency range are not used.

5.1.7.4 Calibration Standard Model

A model of a calibration standard presented as an equivalent circuit is used for determining of S-parameters of the standard. The model is employed for standards of OPEN, SHORT, FIXED LOAD, THRU/LINE types.

One-port model is used for the standards OPEN, SHORT, and FIXED LOAD (See figure 5.4).

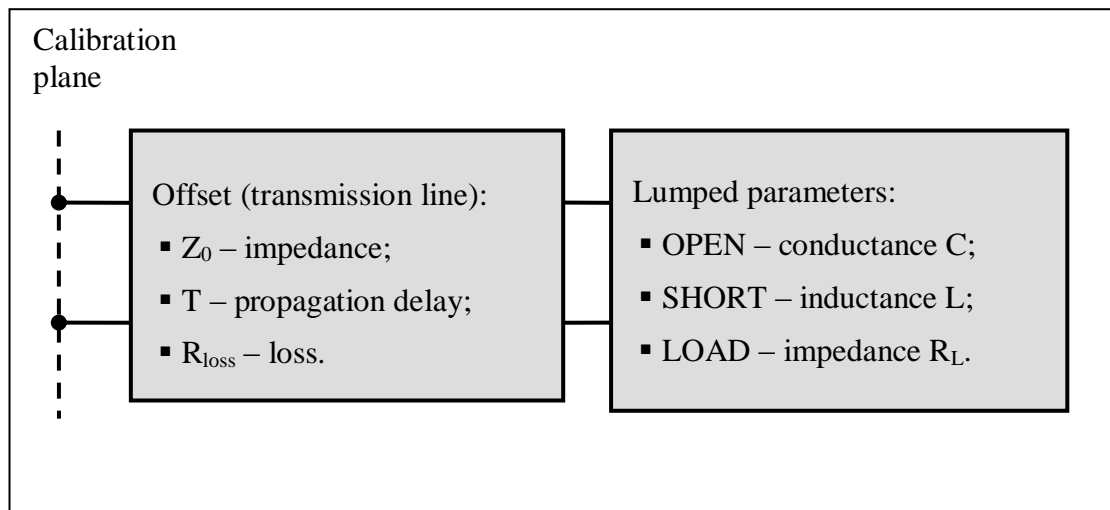

Figure 5.4 One-port standard model

Two-port model is used for the standard THRU/LINE (See figure 5.5).

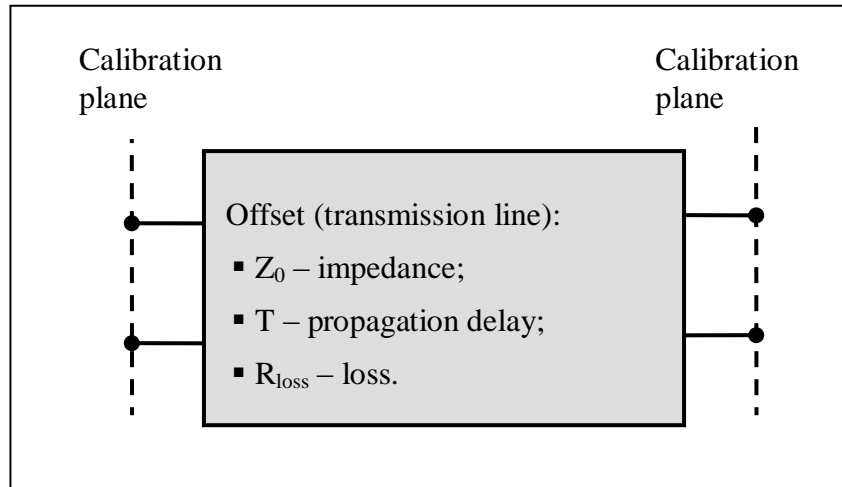

Figure 5.5 Two-port standard model

The description of the numeric parameters of an equivalent circuit model of a calibration standard is shown in table 5.3.

Table 5.3 Parameters of the calibration standard equivalent circuit model

Parameter (as in the program)	Parameter Definition
Z₀ (Offset Z0)	For a one-port standard, it is the offset impedance (of a transmission line) between the calibration plane and the circuit with lumped parameters. For a two-port standard, it is the transmission line impedance between the two calibration planes.
T (Offset Delay)	The offset delay. It is defined as one-way propagation time (in seconds) from the calibration plane to the circuit with lumped parameters or to the other calibration plane. Each standard delay can be measured or mathematically determined by dividing the exact physical length by the propagation velocity.
R_{loss} (Offset Loss)	The offset loss in one-way propagation due to the skin effect. The loss is defined in Ω/sec at 1 GHz frequency. The loss in a transmission line is determined by measuring the delay T [sec] and loss L [dB] at 1 GHz frequency. The measured values are used in the following formula: $Rn[\Omega/s] = \frac{L[\text{dB}] \cdot Z_0[\Omega]}{4.3429[\text{dB}] \cdot T[\text{s}]}$
R_{load} (Load Impedance)	Load impedance in $[\Omega]$.

C (C0, C1, C2, C3)	The fringe capacitance of an OPEN standard, which causes a phase offset of the reflection coefficient at high frequencies. The fringe capacitance model is described as a function of frequency, which is a polynomial of the third degree: $C = C_0 + C_1 f + C_2 f^2 + C_3 f^3$, where f – frequency [Hz] C ₀ ...C ₃ – polynomial coefficients Units: C ₀ [F], C ₁ [F/Hz], C ₂ [F/Hz ²], C ₃ [F/Hz ³]
L (L0, L1, L2, L3)	The residual inductance of a SHORT standard, which causes a phase offset of the reflection coefficient at high frequencies. The residual inductance model is described as a function of frequency, which is a polynomial of the third degree: $L = L_0 + L_1 f + L_2 f^2 + L_3 f^3$, where f – frequency [Hz] L ₀ ...L ₃ – polynomial coefficients Units: L ₀ [H], L ₁ [H/Hz], L ₂ [H/Hz ²], L ₃ [H/Hz ³]

5.1.7.5 Data-Based Calibration Standards

The calibration standards defined by data are set using the table of S-parameters. Each line of the table contains frequency and S-parameters of the calibration standard. For one-port standards the table contains the value of only one parameter – S₁₁, and for two-port standards the table contains the values of all the four parameters – S₁₁, S₂₁, S₁₂, S₂₂.

The table of S-parameters can be filled in manually by the user or downloaded from a file of Touchstone format. Files with *.s1p extension are used for one-port standards, and files with *.s2p extension are used for two-port standards.

5.1.7.6 Scope of Calibration Standard Definition

Different methods of calibration apply either full or partial definitions of the calibration standard kits.

The full two-port calibration, full one-port calibration, one-path two-port calibration, and normalization use fully defined calibration standards, i.e. the standards with known S-parameters. The S-parameters of OPEN, SHORT, LOAD, and THRU/LINE must be defined by the model or by data.

Note

The UNKNOWN THRU and SLIDING LOAD standards are exceptional in the above calibrations. The S-parameters of these standards are defined in the process of calibration. UNKNOWN THRU is used only in full two-port calibration.

TRL calibration and its modifications (TRM, LRL, LRM) apply partial definition of the standards:

- TRL THRU standards must have the required value of Z₀ (S₁₁=S₂₂=0) and known length (delay),

- TRL LINE/MATCH standard must have the same value of Z0 as the first standard,
- TRL REFLECT standard must have the phase known as accurately as $\pm 90^\circ$.

5.1.7.7 Classes of Calibration Standards

Along with defining a calibration standard by a calibration model or data, the standard should also be assigned a specific class. One calibration standard may belong to several classes. The class assignment is performed for each particular calibration kit. The procedure of class assignment to the calibration standards is described in section 5.3.4.

Class assignment to a calibration standard is required for specifying such properties as the calibration method, the role of a standard in the calibration, and the number of the port(s). The Analyzer supports the following classes of the calibration standards (See table 5.4).

Table 5.4 Classes of the calibration standards

Calibration Methods	Class Label	Port
Full 2/3/4-Port Calibration Full 1-Port Calibration One-Path 2-Port Calibration Transmission Normalization Reflection Normalization	OPEN	1, 2, 3, 4
	SHORT	
	LOAD	
	THRU	1-2, 1-3, 1-4, 2-3, 2-4, 3-4
TRL/LRL/TRM/LRM Calibration	TRL THRU	1-2, 1-3, 1-4, 2-3, 2-4, 3-4
	TRL LINE/MATCH	
	TRL REFLECT	1, 2, 3, 4

For example, if you assign the class "OPEN of port 1" to the OPEN -F- calibration standard, it will indicate that this standard is used for calibrating the first port using the following calibration methods: full 2/3/4-port, full 2-port, one-path 2-port, and normalization.

Note

The classes of the standards assigned by the Class Assignment function will appear as labels on the related softkeys in the calibration menu.

5.1.7.8 Subclasses of Calibration Standards

Subclasses are used for assignment of one class to several calibration standards. The procedure of subclass assignment is mainly employed for calibration within a wide frequency range by several calibration standards, each of which does not cover the full frequency range. Each class of standards can contain up to 8 subclasses.

For example, in your calibration kit the LOAD standard is defined as from 0 GHz to 2 GHz, and the LINE standard is defined as from 1.5 GHz to 12 GHz. To perform the TRM/TRL calibration within the full frequency range the LOAD should be assigned the subclass 1, and the LINE should be assigned the subclass 2 of the "TRL line/match" class.

If the standards have an overlapping frequency range (as in the example above, from 1.5 GHz to 2 GHz), the last measured standard will be used in the overlapped region.

Note

Multiple subclass assignment changes the structure of the calibration softkeys. The measurement softkey is replaced by the key, which opens the subclass menu containing the keys for measuring several calibration standards.

5.2 Calibration Procedures

5.2.1 Calibration Kit Selection

The calibration kit employed during a calibration should be selected according to the following procedure. If it is not specified in the list of the predefined calibration kits, you should add it. The procedure of adding and editing of the calibration kits is described in the section 5.3.



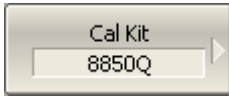



To open the list of the calibration kits (See figure 5.6), use the following softkeys:

Calibration > Cal Kit

	Label	Description	Select	Predefined	Modified	#STDs	
2	85032B/E	Type-N 50Ω 6GHz Cal Kit (Agilent)	<input type="checkbox"/>	Yes	No	6	
3	85032F	Type-N 50Ω 9GHz Cal Kit (Agilent)	<input type="checkbox"/>	Yes	No	8	
4	85054B	Type-N 50Ω 18GHz Cal Kit with Sliding Load (Agilent)	<input type="checkbox"/>	Yes	No	8	
5	85054D	Type-N 50Ω 18GHz Cal Kit (Agilent)	<input type="checkbox"/>	Yes	No	6	
6	05CK10A-150	Type-N 50Ω 18GHz Cal Kit (Rosenberger)	<input type="checkbox"/>	Yes	No	6	
7	8850Q	Type-N 50Ω 18GHz Cal Kit (Maury Microwave)	<input checked="" type="checkbox"/>	Yes	No	6	
8	8850C	Type-N 50Ω 18GHz Cal Kit with Sliding Load (Maury Micro)	<input type="checkbox"/>	Yes	No	8	
9	85033D/E	3.5 mm 6GHz/9GHz Cal Kit (Agilent)	<input type="checkbox"/>	Yes	No	6	
10	85052B	3.5 mm 26.5GHz Cal Kit with Sliding Load (Agilent)	<input type="checkbox"/>	Yes	No	10	

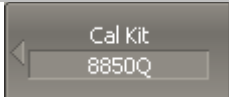
Figure 5.6 List of calibration kits





Highlight the required line in the list of the calibration kits and use the following softkey:

Select

Or click on the checkbox in the row "Select" by the mouse.

Note Make sure that the selected calibration kit is checkmarked.

5.2.2 Reflection Normalization

Reflection normalization is the simplest calibration method used for reflection coefficient measurements. Only one standard (SHORT or OPEN) is measured (See figure 5.7) in the process of this calibration. You can also perform optional directivity calibration by measuring a LOAD standard.

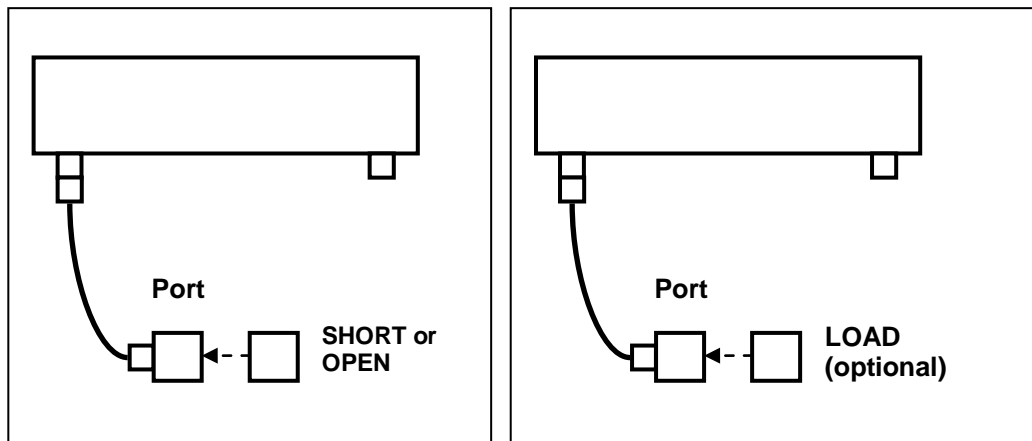

Figure 5.7 Reflection normalization

Before starting calibration perform the following settings: select active channel, set the parameters of the channel (frequency range, IF bandwidth, etc), and select the calibration kit.



To open reflection normalization submenu, use the following softkeys:

Calibration > Calibrate > Response (Open) | Response (Short)

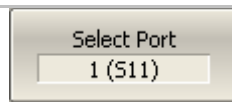

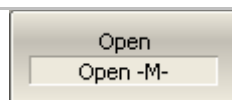

Select the test port to be calibrated using **Select Port**.

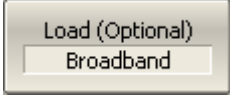

Connect an OPEN or a SHORT standard to the test port as shown in figure 5.7. Perform measurement using **Open** or **Short** softkey respectively.

The instrument status bar will indicate **Calibration in progress...** when the measurement is in progress. On completion of the measurement, a check mark will appear in the left part of the softkey.

	<p>To perform the optional directivity calibration, connect a LOAD standard to the test port as shown in figure 5.7 and perform measurement using Load (Optional) softkey.</p> <p>The instrument status bar will indicate Calibration in progress... when the measurement is in progress. On completion of the measurement a check mark will appear in the left part of the softkey.</p>
	<p>To complete the calibration procedure, click Apply.</p> <p>This will activate the process of calibration coefficient table calculation and saving it into the memory. The error correction function will also be automatically enabled.</p>
	<p>To clear the measurement results of the standards, click Cancel.</p> <p>This softkey does not cancel the current calibration. To disable the current calibration turn off the error correction function (See section 5.2.10).</p>
Note	<p>You can check the calibration status in channel status bar (See table 5.5) or in trace status field (See table 5.6).</p>

5.2.3 Transmission Normalization

Transmission normalization is the simplest calibration method used for transmission coefficient measurements. One THRU standard is measured (See figure 5.8) in the process of this calibration. You can also perform optional isolation calibration by measuring two LOAD standards.

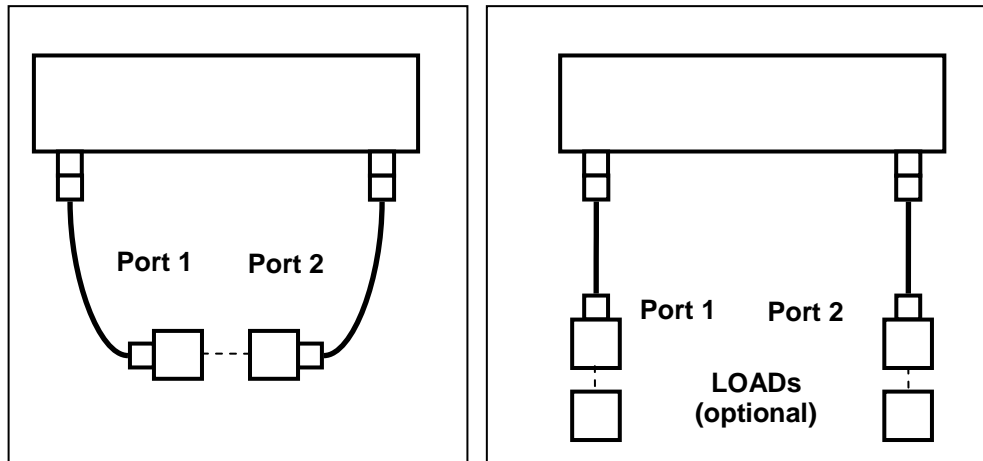

Figure 5.8 Transmission normalization

Before starting calibration perform the following settings: select active channel, set the parameters of the channel (frequency range, IF bandwidth, etc), and select the calibration kit.



To open transmission normalization submenu, use the following softkeys:

Calibration > Calibrate > Response (Thru)

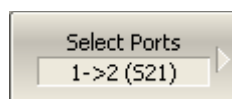



Select the direction of the calibration using **Select Ports** softkey. The label on the softkey indicates the following: source port → receiver port (measured parameter).

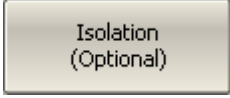

Connect a THRU standard between the test ports. If the port connectors allow through connection connect them directly (zero electrical length thru). Perform measurement using **Thru** softkey.

The instrument status bar will indicate **Calibration in progress...** when the measurement is in progress. On completion of the measurement a check mark will appear in the left part of the softkey.

	<p>To perform the optional isolation calibration, connect two LOAD standards to the test ports as shown in figure 5.8 and enable measurement using Isolation (Optional) softkey.</p> <p>The instrument status bar will indicate Calibration in progress... when the measurement is in progress. On completion of the measurement a check mark will appear in the left part of the softkey.</p>
	<p>To complete the calibration procedure, click Apply.</p> <p>This will activate the process of calibration coefficient table calculation and saving it into the memory. The error correction function will also be automatically enabled.</p>
	<p>To clear the measurement results of the standard, click Cancel.</p> <p>This softkey does not cancel the current calibration. To disable the current calibration, turn off the error correction function (See section 5.2.10).</p>
Note	<p>You can check the calibration status in channel status bar (See table 5.5) or in trace status field (See table 5.6).</p>

5.2.4 Full 1-Port Calibration

Full one-port calibration is used for reflection coefficient measurements. The three calibration standards (SHORT, OPEN, LOAD) are measured (See figure 5.9) in the process of this calibration.

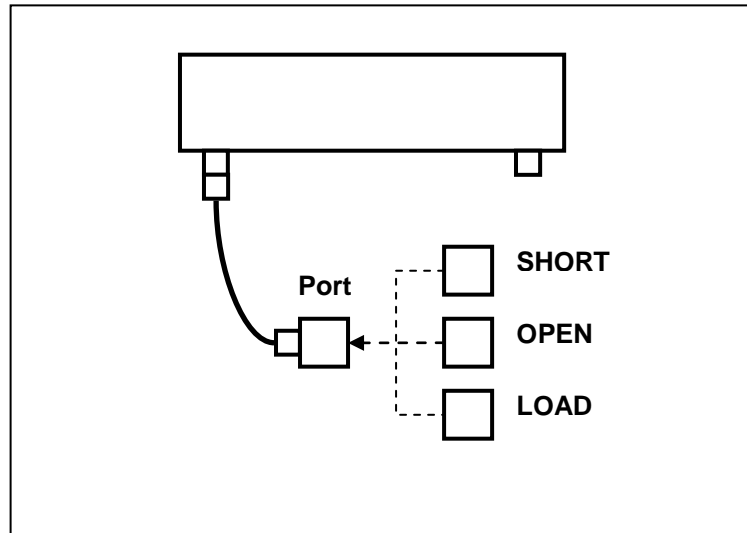
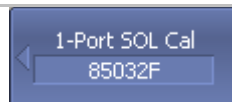

Figure 5.9 Full 1-port calibration

Before starting calibration perform the following settings: select active channel, set the parameters of the channel (frequency range, IF bandwidth, etc), and select the calibration kit.



To open full one-port calibration submenu, use the following softkeys:

Calibration > Calibrate > 1-Port SOL Cal

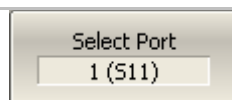

Select the test port to be calibrated using **Select Port**.

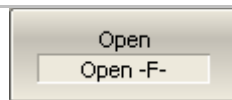

Connect SHORT, OPEN and LOAD standards to the selected test port in any consequence as shown in figure 5.9. Perform measurements clicking the softkey corresponding to the connected standard.

The instrument status bar will indicate **Calibration in progress...** when the measurement is in progress. On completion of the measurement a check mark will appear in the left part of the softkey.



To complete the calibration procedure, click **Apply**.

This will activate the process of calibration coefficient table calculation and saving it into the memory. The error correction function will also be automatically enabled.



To clear the measurement results of the standards, click **Cancel**.

This softkey does not cancel the current calibration. To disable the current calibration, turn off the error correction function (See section 5.2.10).

Note

You can check the calibration status in channel status bar (See table 5.5) or in trace status field (See table 5.6).

5.2.5 One-Path 2-Port Calibration

One-path two-port calibration is used for measurements of the DUT parameters in one direction, e.g. S_{11} and S_{21} . This method involves connection of the three calibration standards to the source port, and connection of a THRU standard between the calibrated source port and the receiver port (See figure 5.10). You can also perform optional isolation calibration by measuring two LOAD standards.

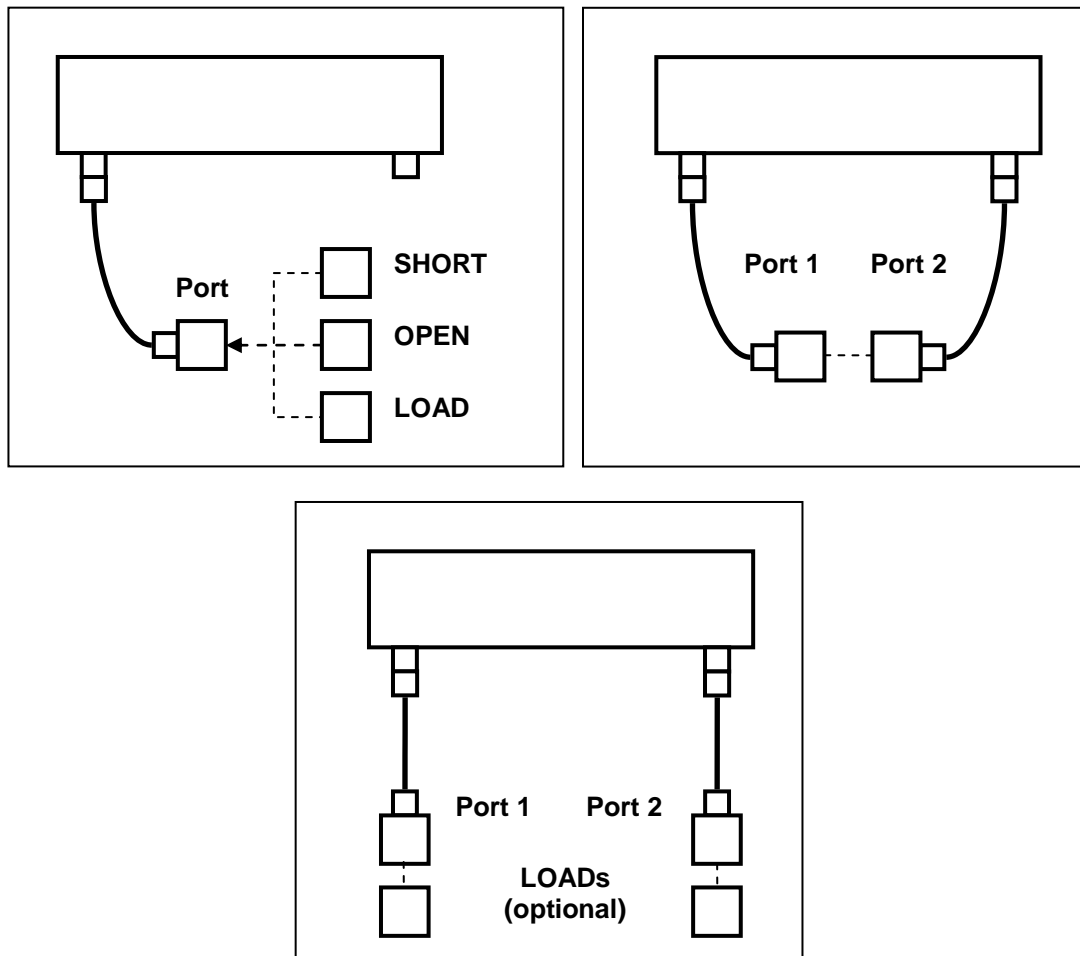

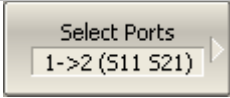
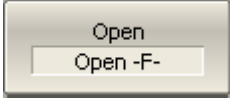

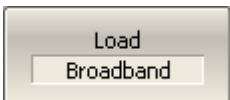

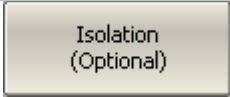

Figure 5.10 One-path 2-port calibration

Before starting calibration perform the following settings: select active channel, set the parameters of the channel (frequency range, IF bandwidth, etc), and select the calibration kit.



To open one-path two-port calibration submenu, use the following softkeys:

Calibration > Calibrate > One Path 2-Port Cal

	<p>Select the direction of the calibration using Select Ports softkey. The label on the softkey indicates the following: source port → receiver port (measured parameters).</p>
   	<p>Connect SHORT, OPEN and LOAD standards to the source port in any consequence, as shown in figure 5.10. Perform measurements clicking the softkey corresponding to the connected standard.</p> <p>Connect a THRU standard between the test ports. If the port connectors allow through connection connect them directly (zero electrical length thru). Perform measurement using Thru softkey.</p> <p>The instrument status bar will indicate Calibration in progress... when the measurement is in progress. On completion of the measurement a check mark will appear in the left part of the softkey.</p>
	<p>To perform the optional isolation calibration, connect two LOAD standards to the test ports as shown in figure 5.10 and enable measurement using Isolation (Optional) softkey.</p> <p>The instrument status bar will indicate Calibration in progress... when the measurement is in progress. On completion of the measurement a check mark will appear in the left part of the softkey.</p>
	<p>To complete the calibration procedure, click Apply.</p> <p>This will activate the process of calibration coefficient table calculation and saving it into the memory. The error correction function will also be automatically enabled.</p>
	<p>To clear the measurement results of the standards, click Cancel.</p> <p>This softkey does not cancel the current calibration. To disable the current calibration, turn off the error correction function (See section 5.2.10).</p>
<p>Note</p>	<p>You can check the calibration status in channel status bar (See table 5.5) or in trace status field (See table 5.6).</p>

5.2.6 Full 2-Port Calibration

Full 2-port calibration combines two one-port calibrations for each test port with measurement of a THRU standard between ports (See figure 5.11). You can also perform optional isolation calibration by measuring two LOAD standards.

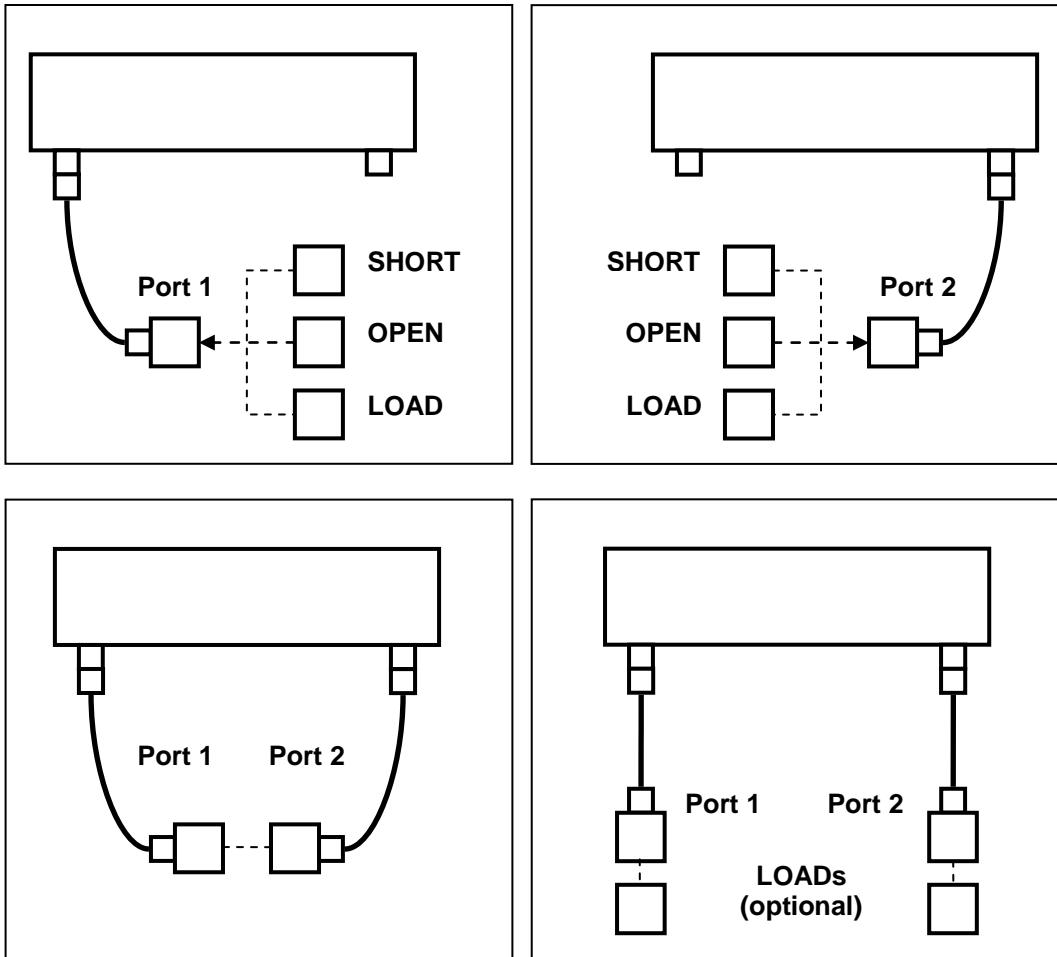

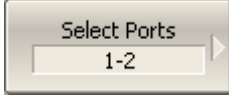
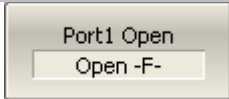

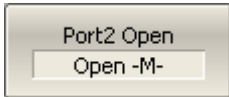

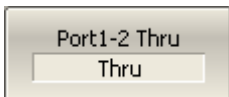
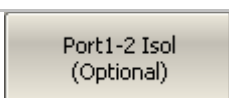

Figure 5.11 Full 2-port calibration

Before starting calibration perform the following settings: select active channel, set the parameters of the channel (frequency range, IF bandwidth, etc), and select the calibration kit.



To open full 2-port calibration submenu, use the following softkeys:

Calibration > Calibrate > 2-Port SOLT Cal

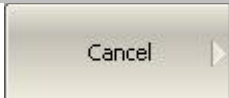
	<p>Select the port pair to be calibrated using Select Ports softkey.</p>
	<p>Connect SHORT, OPEN and LOAD standards to the first and to the second ports in any consequence, as shown in figure 5.11. Perform measurements clicking the softkey corresponding to the connected standard.</p> <p>Connect a THRU standard between the test ports. If the port connectors allow through connection connect them directly (zero electrical length thru). Perform measurement using Port 1–2 Thru softkey.</p> <p>The instrument status bar will indicate Calibration in progress... when the measurement is in progress. On completion of the measurement a check mark will appear in the left part of the softkey.</p>
	
	
	
	
	
	
	
	<p>To complete the calibration procedure, click Apply.</p> <p>This will activate the process of calibration coefficient table calculation and saving it into the memory. The error correction function will also be automatically enabled.</p>
	<p>To clear the measurement results of the standards, click Cancel.</p> <p>This softkey does not cancel the current calibration. To disable the current calibration, turn off the error correction function (See section 5.2.10).</p>
<p>Note</p>	<p>You can check the calibration status in channel status bar (See table 5.5) or in trace status field (See table 5.6).</p>

5.2.7 Full 3-Port Calibration

Full 3-port calibration combines three 1-port calibrations for each test port with measurements of a THRU standard between 3 port pairs. 1 out of 3 THRU measurements can be omitted (see Simplified 3/4-Port Calibration). You can also perform optional isolation calibration by measuring two LOAD standards for each port pair.

Before starting calibration perform the following settings: select active channel, set the parameters of the channel (frequency range, IF bandwidth, etc), and select the calibration kit.



To open full 3-port calibration submenu, use the following softkeys:

Calibration > Calibrate > 3-Port SOLT Cal

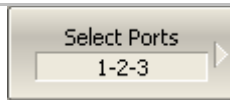

Select the ports to be calibrated using **Select Ports** softkey.



For each of the 3 ports repeat the following:

1. Click **Reflection Port n**

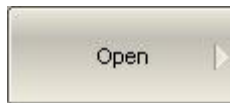

2. Connect SHORT, OPEN and LOAD standards to the selected port in any consequence. Perform measurements clicking the softkey corresponding to the connected standard.



The instrument status bar will indicate **Calibration in progress...** when the measurement is in progress. On completion of the measurement a check mark will appear in the left part of the softkey.



For the 3 pairs of ports (or for 2 pairs in case of the simplified calibration) repeat the following:

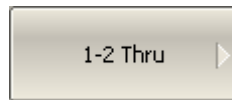

Connect a THRU standard between the test ports. If the port connectors allow through connection connect them directly (zero electrical length thru). Perform measurement using **n–m Thru** softkey.



The instrument status bar will indicate **Calibration in progress...** when the measurement is in progress. On completion of the measurement a check mark will appear in the left part of the softkey.

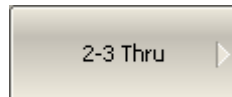

Upon completion of the two measurements, the label on the remaining softkey changes to **Optional**, what indicates that for simplified calibration a sufficient number of measurements have been performed.



To perform the optional isolation calibration click **Isolation (Optional)**, then for each port pair repeat the following:



Connect two LOAD standards to the test port pair and enable measurement using **Port n–m Isol (Optional)** softkey.



The instrument status bar will indicate **Calibration in progress...** when the measurement is in progress. On completion of the measurement a check mark will appear in the left part of the softkey.

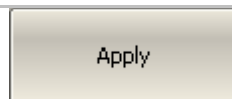

To complete the calibration procedure, click **Apply**.

This will activate the process of calibration coefficient table calculation and saving it into the memory. The error correction function will also be automatically enabled.



To clear the measurement results of the standards, click **Cancel**.

This softkey does not cancel the current calibration. To disable the current calibration, turn off the error correction function (See section 5.2.10).

Note

You can check the calibration status in channel status bar (See table 5.5) or in trace status field (See table 5.6).

5.2.8 Full 4-Port Calibration

Full 4-port calibration combines four 1-port calibrations for each test port with measurements of a THRU standard between 6 port pairs. Up to 3 out of 6 THRU measurements can be omitted (see Simplified 3/4-Port Calibration). You can also perform optional isolation calibration by measuring two LOAD standards for each port pair.

Before starting calibration perform the following settings: select active channel, set the parameters of the channel (frequency range, IF bandwidth, etc), and select the calibration kit.



To open full 4-port calibration submenu, use the following softkeys:

Calibration > Calibrate > 4-Port SOLT Cal

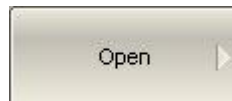

For each of the 4 ports repeat the following:

1. Click **Reflection Port n**
2. Connect SHORT, OPEN and LOAD standards to the selected port in any consequence. Perform measurements clicking the softkey corresponding to the connected standard.

The instrument status bar will indicate **Calibration in progress...** when the measurement is in progress. On completion of the measurement a check mark will appear in the left part of the softkey.



To start THRU measurements, click **Transmission**.

Then for the 6 pairs of ports (or less in case of the simplified calibration) repeat the following:

Connect a THRU standard between the test ports. If the port connectors allow through connection connect them directly (zero electrical length thru). Perform measurement using **n-m Thru** softkey.

The instrument status bar will indicate **Calibration in progress...** when the measurement is in progress. On completion of the measurement a check mark will appear in the left part of the softkey.

Upon completion of the three measurements, the labels on the remaining softkeys change to **Optional** or to **Recommended**, what indicates that for simplified calibration a sufficient number of measurements have been performed. The **Recommended** label indicates recommendation to perform an additional measurement to enhance accuracy.

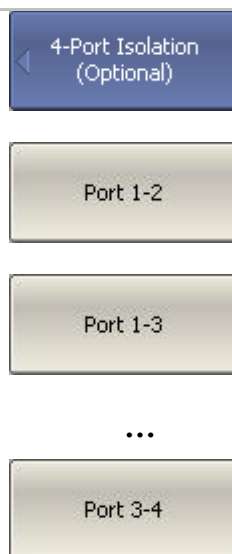

To perform the optional isolation calibration click **Isolation (Optional)**, then for each port pair repeat the following:

Connect two LOAD standards to the test port pair and enable measurement using **Port n-m Isol (Optional)** softkey.

The instrument status bar will indicate **Calibration in progress...** when the measurement is in progress. On completion of the measurement a check mark will appear in the left part of the softkey.

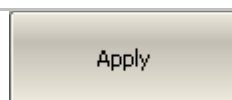

To complete the calibration procedure, click **Apply**.

This will activate the process of calibration coefficient table calculation and saving it into the memory. The error correction function will also be automatically enabled.



To clear the measurement results of the standards, click **Cancel**.

This softkey does not cancel the current calibration. To disable the current calibration, turn off the error correction function (See section 5.2.10).

Note You can check the calibration status in channel status bar (See table 5.5) or in trace status field (See table 5.6).

5.2.9 Unknown Thru Calibration

The unknown thru calibration procedure is same as the one for a full 2/3/4-port calibration described in the previous sections.

To be able to perform the unknown thru calibration, first add UNKNOWN THRU standard to the description of the calibration kit and assign the class to it. After that, the unknown thru measurement softkey will become available in the 2/3/4-port calibration menu.

See section 5.3.2 for a calibration standard definition in a calibration kit. When adding the unknown thru standard to a kit you should specify just two parameters: UNKNOWN THRU type of the standard and approximate delay of propagation in one direction. You can enter zero value for delay for it to be automatically determined during calibration (See section 5.1.6.8).

See section 5.3.4 for the calibration standard class assignment. A newly added UNKNOWN THRU standard is to be assigned to “Thru, Port n-m” class.

Note The user does not have to perform the procedure of adding UNKNOWN THRU described above for predefined calibration kits. The predefined calibration kits already include the UNKNOWN THRU standard.

5.2.10 2-Port TRL Calibration

TRL calibration requires the use of the following three calibration standards (See figure 5.12):

1. Zero-length THRU or a LINE assigned TRL THRU class. Hereinafter LINE is understood as a matched line. In coaxial transmission lines, it is common that 50- Ω airlines are used as LINES.
2. SHORT or OPEN assigned TRL REFLECT class. The sameness of the standards connected to the ports is a strict requirement.
3. LINE or a pair of MATCHes assigned TRL LINE/MATCH class. A pair of MATCHes connected to two test ports is equal to an infinite-length LINE.

Note

TRL calibration has a limited frequency range: the ratio of the upper frequency to the lower frequency should not exceed 8:1. To compensate for this limitation, use more than one LINE of TRL LINE/MATCH class (See Calibration Using Subclasses below).

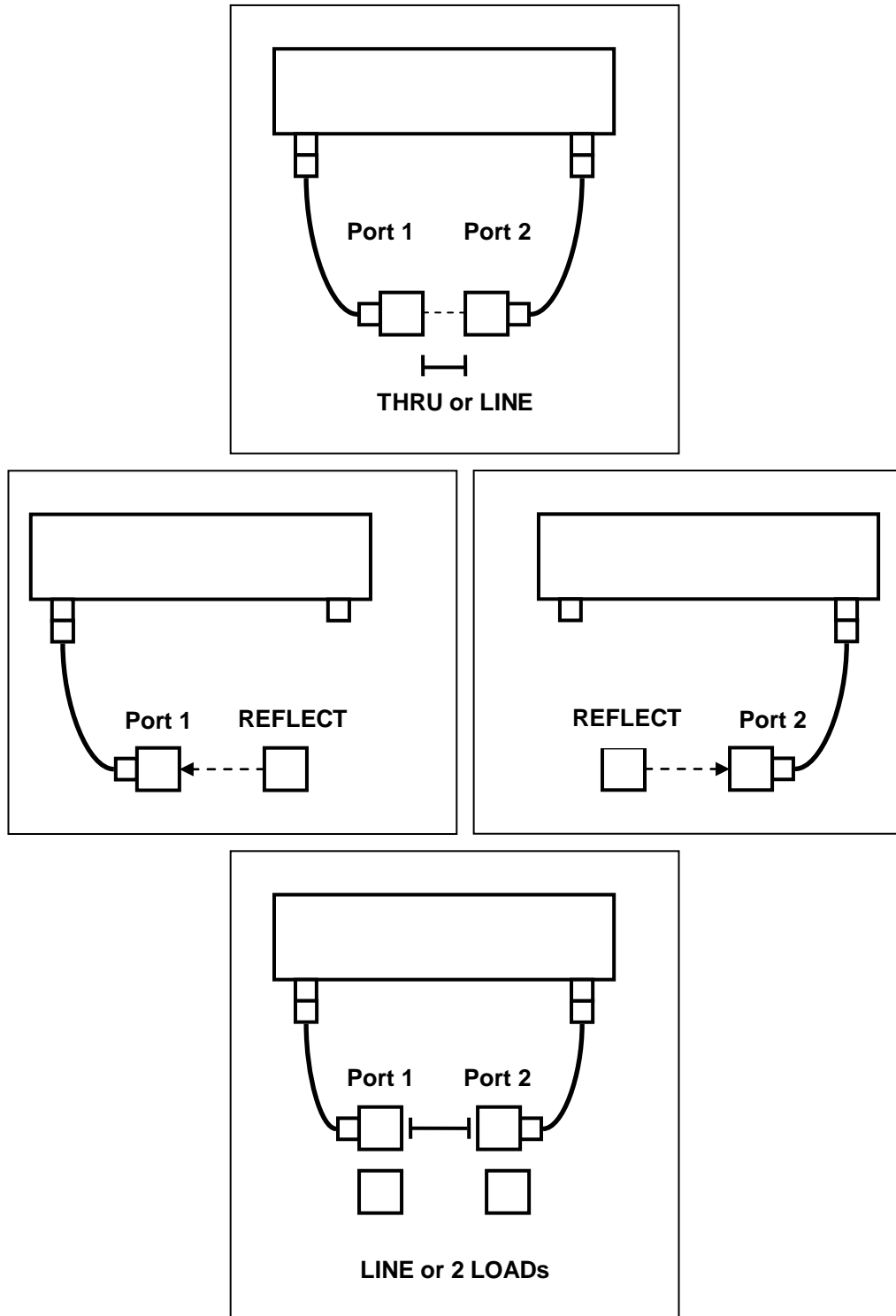

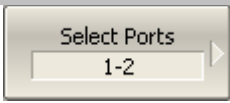
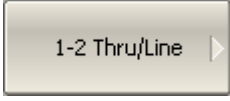

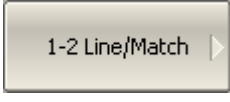



Figure 5.12 TRL calibration







Before starting calibration, perform the following settings: select active channel, set the parameters of the channel (frequency range, IF bandwidth, etc), select the calibration kit.

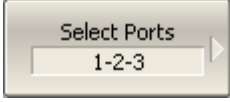

	<p>To open TRL calibration submenu, use the following softkeys:</p> <p>Calibration > Calibrate > 2-Port TRL Cal</p>
	<p>Select the port pair to be calibrated using Select Ports softkey.</p>
	<p>Connect a TRL THRU (THRU or LINE) standard between the test ports. Perform measurement using 1-2 Thru/Line softkey.</p>
	<p>Connect a TRL REFLECT standard to the test ports in any order. Perform measurement using Port 1 Reflect and Port 2 Reflect softkey.</p>
	<p>Connect a TRL LINE/MATCH (LINE between the test ports and 2 LOADs to each port). Perform measurement using Port 1-2 Line/Match softkey.</p>
	<p>The instrument status bar will indicate Calibration in progress... when the measurement is in progress. On completion of the measurement a check mark will appear in the left part of the softkey.</p>
	<p>To complete the calibration procedure, click Apply.</p> <p>This will activate the process of calibration coefficient table calculation and saving it into the memory. The error correction function will also be automatically enabled.</p>
	<p>To clear the measurement results of the standards, click Cancel.</p> <p>This softkey does not cancel the current calibration. To disable the current calibration, turn off the error correction function (See section 5.2.10).</p>
<p>Note</p>	<p>You can check the calibration status in channel status bar (See table 5.5) or in trace status field (See table 5.6).</p>

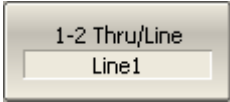
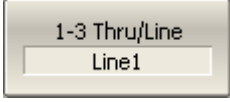
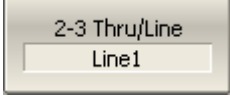
5.2.113-Port TRL Calibration

A 3-Port TRL calibration consists of three 2-port TRL calibrations between three pairs of ports. For example, when 1-2-3 ports are calibrated, three 2-port TRL calibrations between ports 1-2, 1-3 and 2-3 must be performed.

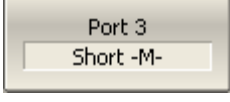
A simplified 3-port calibration consists of two 2-port TRL calibrations. For example, when 1-2-3 ports are calibrated, two 2-port TRL calibrations between any pairs of ports must be performed (e.g. 1-2 and 1-3).

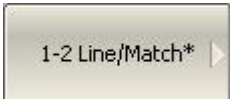
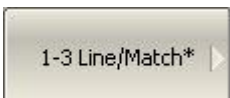
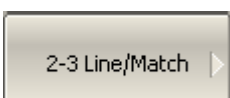
 <p>3-Port TRL Cal 05CK120-150</p>	<p>To open 3-Port TRL calibration submenu, use the following softkeys:</p>
<p>Calibration > Calibrate > 3-Port TRL Cal</p>	
 <p>Select Ports 1-2-3</p>	<p>Select the three ports to be calibrated using Select Ports softkey.</p>
 <p>TRL Thru/Line 05CK120-150</p>	<p>To perform measurement of the TRL THRU, click Thru/Line.</p>
 <p>1-2 Thru/Line Line1</p>	<p>Then for the 3 pairs of ports (or for 2 pairs in case of the simplified calibration) repeat the following:</p>
 <p>1-3 Thru/Line Line1</p>	<p>Connect a TRL THRU (THRU or LINE) standard between the test ports. Perform measurement using m-n Thru/Line softkey.</p>
 <p>2-3 Thru/Line Line1</p>	<p>The instrument status bar will indicate Calibration in progress... when the measurement is in progress. On completion of the measurement a check mark will appear in the left part of the softkey.</p>
<p>Upon completion of the two measurements, the label on the remaining softkey changes to Optional, what indicates that for simplified calibration a sufficient number of measurements have been performed.</p>	
 <p>TRL Reflect 05CK120-150</p>	<p>To perform measurement of the TRL REFLECT, click Reflect.</p>
 <p>Port 1 Short -M-</p>	<p>Then for the 3 ports repeat the following:</p>
 <p>Port 2 Short -M-</p>	<p>Connect a TRL REFLECT standard to the test ports in any order. Perform measurement using Port n softkey.</p>
 <p>Port 3 Short -M-</p>	<p>The instrument status bar will indicate Calibration in progress... when the measurement is in progress. On completion of the measurement a check mark will appear in the left part of the softkey.</p>

	<p>To perform measurement of the TRL LINE, click Line/Match.</p>
	<p>For the 3 pairs of ports (or for 2 pairs in case of the simplified calibration) repeat the following:</p>
	<p>Connect a TRL LINE/MATCH (LINE between the test ports or 2 LOADs to each port). Perform measurement using Port m-n Line/Match softkey.</p>
	<p>The asterisk on the softkey labels prompts what pairs of ports have been calibrated with the TRL THRU standard.</p>
	<p>The instrument status bar will indicate Calibration in progress... when the measurement is in progress. On completion of the measurement a check mark will appear in the left part of the softkey.</p>
	<p>Upon completion of the two measurements, the label on the remaining softkey changes to Optional, what indicates that for simplified calibration a sufficient number of measurements have been performed.</p>
	<p>To complete the calibration procedure, click Apply.</p>
	<p>This will activate the process of calibration coefficient table calculation and saving it into the memory. The error correction function will also be automatically enabled.</p>
	<p>To clear the measurement results of the standards, click Cancel.</p>
	<p>This softkey does not cancel the current calibration. To disable the current calibration, turn off the error correction function (See section 5.2.10).</p>
<p>Note</p>	<p>You can check the calibration status in channel status bar (See table 5.5) or in trace status field (See table 5.6).</p>

5.2.12 4-Port TRL Calibration

A 4-Port TRL calibration consists of six 2-port TRL calibrations between six pairs of ports: 1-2, 1-3, 1-4, 2-3, 2-4, and 3-4.

The 4-port TRL calibration with full set of standards is a time consuming procedure. A simplified 4-port TRL calibration can be performed instead. There are two options of the simplified 4-port TRL calibration:

- I. The simplified 4-port TRL calibration, which consists of three or more 2-port TRL calibrations. The minimum number of three 2-port TRL calibrations is required in case of the star topology of the calibration setup (with one common port), for example 1-2, 1-3, and 1-4. If the topology is not star, minimum of four 2-port TRL calibrations is required.
- II. The simplified 4-port TRL calibration, which consists of the combination of two 2-port TRL calibrations and two THRU measurements. The two TRL calibrations are performed for pairs of nonadjacent ports, e.g. 1-2 and 3-4. The THRU measurements are performed for the remaining pairs of ports, e.g. 1-3 and 1-4. Two THRU measurements is the required minimum. To enhance the reliability of the calibration, up to four THRU measurements can be performed.

The THRU used in this calibration is the standard assigned TRL THRU class (see Calibration Standard Class Assignment). This should be the same standard, which is used in TRL calibration (LINE or FLUSH THRU), or a specific THRU.

Note	The specific THRU will appear in the TRL calibration menu when TRL THRU class is assigned to it. However, it can be used as a THRU only in the simplified calibration, but cannot be used as a “native” TRL standard (LINE or FLUSH THRU).
------	--



To open 4-Port TRL calibration submenu, use the following softkeys:

Calibration > Calibrate > 4-Port TRL Cal



To perform measurements of the TRL THRU, click **Thru/Line**.

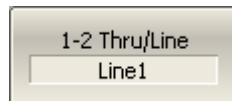

For the calibration with the full set of standards, perform 6 measurements of the TRL THRU (THRU or LINE);

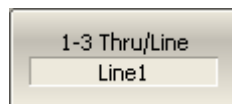

For the simplified calibration I, perform 3 measurements of the TRL THRU (THRU or LINE) with one common port;

...

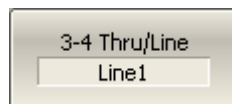

For the simplified calibration II, perform 2 measurements of the TRL THRU (THRU or LINE) of 2 pairs of nonadjacent ports. Then perform (at least) 2 measurements of the THRU of the remaining port pairs.

The instrument status bar will indicate **Calibration in progress...** when the measurement is in progress. On completion of the measurement a check mark will appear in the left part of the softkey.

Upon completion of the three measurements, the labels on the remaining softkeys change to **Optional**, what indicates that for simplified calibration I a sufficient number of measurements have been performed. Ignore such labels in case simplified calibration II is performed.



To perform measurements of the TRL REFLECT, click **Reflect**.



Then for the 4 ports repeat the following:







Connect a TRL REFLECT standard to the test ports in any order. Perform measurement using **Port n** softkey.

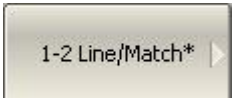
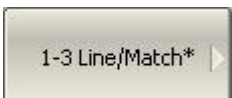

The instrument status bar will indicate **Calibration in progress...** when the measurement is in progress. On completion of the measurement a check mark will appear in the left part of the softkey.



	<p>To perform measurements of the TRL LINE, click Line/Match.</p>
	<p>For the calibration with full set of standards, perform 6 measurements of the TRL LINE (LINE between the test ports or 2 LOADs to each port);</p>
	<p>For the simplified calibration I, perform 3 measurements of the TRL LINE for the same pairs of ports as were used for measurements of TRL THRU (indicated with asterisks);</p>
<p>...</p>	
	<p>For the simplified calibration II, perform 2 measurements of the TRL LINE for the same pairs of nonadjacent ports as were used for measurements of TRL THRU. Note that asterisks cannot serve as a prompt!</p>
	<p>The instrument status bar will indicate Calibration in progress... when the measurement is in progress. On completion of the measurement a check mark will appear in the left part of the softkey.</p>
	<p>Upon completion of the two or three measurements, the labels on the remaining softkeys change to Optional, what indicates that for simplified calibration a sufficient number of measurements have been performed.</p>
	<p>To complete the calibration procedure, click Apply.</p> <p>This will activate the process of calibration coefficient table calculation and saving it into the memory. The error correction function will also be automatically enabled.</p>
	<p>To clear the measurement results of the standards, click Cancel.</p> <p>This softkey does not cancel the current calibration. To disable the current calibration, turn off the error correction function (See section 5.2.10).</p>
<p>Note</p>	<p>You can check the calibration status in channel status bar (See table 5.5) or in trace status field (See table 5.6).</p>

5.2.12.1 Multiline Option of TRL Calibration

A Multiline option consists of the algorithm for computing the “Multiline TRL” coefficients (See Multiline TRL Calibration).

The procedure of Multiline TRL calibration is the same as the procedure of TRL calibration described above. The number of the LINES of various lengths should be no less than three. The Multiline TRL calibration LINES are understood as any LINES no matter if they are assigned TRL THRU or TRL LINE, as in Multiline TRL calibration all the LINES are equal.

First of all create and edit the calibration kit for the Multiline TRL calibration. For details on the data to be entered for the normal and Multiline TRL calibrations see section 5.1.6.10.

Switching between the normal and Multiline TRL calibrations is performed by a specific button in TRL calibration menu.

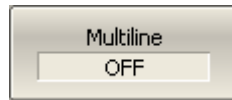

To toggle between normal and Multiline TRL calibrations, use **Multiline** softkey.

5.2.13 Bandsplit Calibration Using Subclasses

If the required frequency range of the calibration exceeds the operating frequency ranges of some calibration standards, use several standards to have the whole required frequency range covered. A calibration kit should contain several standards of each class (e.g. TRL LINE) with some specified frequency limits. Each of such standards will be applied for the measurements within its frequency limits. The total frequency band of all the standards should cover all the required frequency range of the calibration without “gaps”.

When several calibration standards of one class are used for calibration, you should assign subclasses to these standards using the calibration kit editing function. The procedure of subclass assignment is described in section 5.3.4.

Note

When assigning two or more subclasses to one class of calibration standards the calibration menu changes: the standard measurement softkey is replaced by the softkey, which opens the subclass menu containing the list of all the standards of this class.

Further this section describes an example of calibration using the calibration kit for TRL calibration, in which the "TRL LINE/MATCH" class contains 3 subclasses: load (Lowband), line 2 (TRL Line2), and line 3 (TRL Line3).

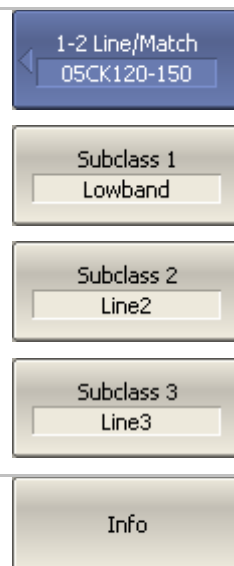

In the main menu of TRL calibration the **1-2 Line/Match** softkey will open the subclass menu (if the above mentioned condition is met).

Connect the Lowband, Line2 and Line3 to the test ports in any consequence and perform measurements clicking the softkey corresponding to the connected standard.

If two standards have an overlapping frequency range the last measured standard will be used in the overlapping region.

To view additional information about each standard frequency range, in which its measurements are applied (See figure 5.13), press **Info** softkey.

1-2 Line/Match	Used in Calculations	STD Label	Applied to Range	
			Fmin	Fmax
Subclass 1	<input checked="" type="checkbox"/>	Lowband	300 kHz	680.2745 MHz
Subclass 2	<input checked="" type="checkbox"/>	Line2	3.600165 GHz	8 GHz
Subclass 3	<input checked="" type="checkbox"/>	Line3	720.273 MHz	3.5601665 GHz
Subclass 4	<input type="checkbox"/>			
Subclass 5	<input type="checkbox"/>			
Subclass 6	<input type="checkbox"/>			
Subclass 7	<input type="checkbox"/>			

Measurement: Ready

Figure 5.13 Information on calibration standard measurements.

5.2.14 Calibration Using Sliding Load

The SLIDING LOAD can be used instead of a FIXED LOAD in full one-port and two-port calibrations.

If a calibration kit contains a SLIDING LOAD, the standard measurement softkey is replaced by the softkey, which opens the submenu containing the SLIDING LOAD calibration logic.

The sliding load calibration involves a series of measurements in different positions of the sliding element. The minimum number of measurements is 5, the maximum number of measurements is 8.



In the main menu of one-port or two-port calibration the **Load** softkey will open the sliding load menu (if the above mentioned condition is met).

Connect the SLIDING LOAD to a selected test ports and perform a series of measurements in different positions of the sliding element clicking the **Position 1**, **Position 2** ... **Position 8** softkeys.

Note

The sliding load had a low cutoff frequency. To perform calibration in the full frequency range, use two loads: FIXED LOAD standard in the lower part of the frequency range, and SLIDING LOAD in the upper frequency range using subclasses (See section 5.2.8).

5.2.15 Error Correction Disabling

This feature allows the user to disable the error correction function, which automatically becomes enabled after completion of calibration by any method.

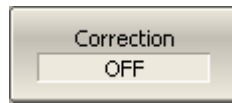
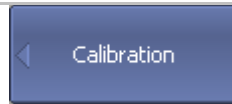

To disable and enable again the error correction function, use the following softkeys:

Calibration > Correction

5.2.16 Error Correction Status

The error correction status is indicated for each trace individually. Also there is a general status of error correction for all the traces of a channel.

The general error correction status for all the S-parameter traces of a channel is indicated in the specific field on a channel status bar (See table 5.5). For channel status bar description, see section 4.2.6.

Table 5.5 General error correction status

Symbol	Definition	Note
Cor	Error correction is enabled. The stimulus settings are the same for the measurement and the calibration.	If the function is active for all the traces – black characters on gray background. If the function is active only for some of the traces (other traces are not calibrated) – white characters on red background.
C?	Error correction is enabled. The stimulus settings are not the same for the measurement and the calibration. Interpolation is applied.	
C!	Error correction is enabled. The stimulus settings are not the same for the measurement and the calibration. Extrapolation is applied.	
Off	Error correction is turned off.	For all the traces. White characters on red background.
---	No calibration data. No calibration was performed.	

The error correction status for each individual trace is indicated in the trace status field (See table 5.6). For trace status field description, see section 4.2.2.

Table 5.6 Trace error correction status

Symbols	Definition
RO	OPEN response calibration
RS	SHORT response calibration
RT	THRU response calibration
OP	One-path 2-port calibration
F1	Full 1-port calibration
F2	Full 2-port or TRL calibration
F3	Full 3-port or TRL calibration
F4	Full 4-port or TRL calibration
SMC	Scalar mixer calibration

5.2.17 System Impedance Z_0

Z_0 is the system impedance of a measurement path. Normally it is equal to the impedance of the calibration standards, which are used for calibration. The Z_0 value should be specified before calibration, as it is used for calibration coefficient calculations.

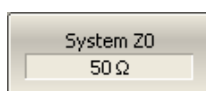

To set the system impedance Z_0 , use the following softkeys:

Calibration > System Z0

Note

Selection of calibration kit automatically determines the system impedance in accordance with the value specified for the kit.

5.2.18 Port Extension

The port extension function enables you to eliminate the fixture effects in the measurement results.

This method involves approximation of the fixture as an ideally matched LINE with or without losses. The method allows for elimination the electrical delay and/or losses introduced by the fixture. The accuracy of this method is approximate as the real fixture does not represent an ideal line.

The function virtually extends the test ports moving the calibration plane to the terminals of the DUT (by the length of the fixture). The fixture parameters are defined by the user for each port individually (See figure 5.14).

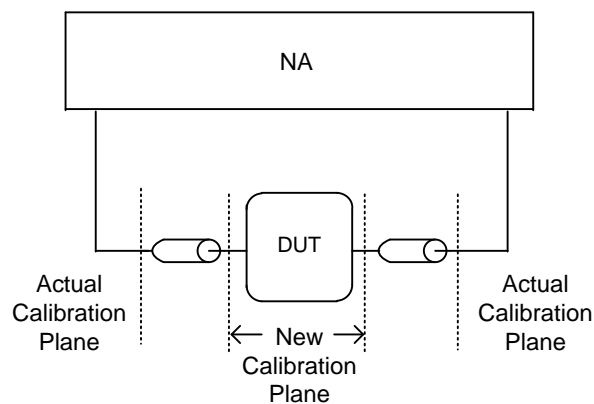

Figure 5.14 Port extension

The phase incursion caused by electrical delay is compensated for, when a lossless fixture needs to be removed:

$$e^{j \cdot 2\pi \cdot f \cdot t}, \quad \text{where}$$

f – frequency, Hz,

t – electrical delay, sec.

The feature of removing a lossless fixture is similar to the feature of electrical delay setting for a trace (See section 4.9.7), but unlike the latter it applies to all the traces of the channel. It compensates for a fixture length in transmission measurements and for a double fixture length in reflection measurements.

To remove a fixture with losses, the following methods of loss defining (in one, two or three frequency points) are applied:

1. Frequency-independent loss at DC - L_0

$$L(f) = L_0$$

2. Frequency-dependent loss determined by the losses in two frequency points: L_0 at DC, and L_1 at frequency F_1

$$L(f) = L_0 + (L_1 - L_0) \sqrt{\frac{f}{F_1}}$$

3. Frequency-dependent loss determined by the losses in three frequency points: L_0 at DC, L_1 at frequency F_1 , and L_2 at frequency F_2

$$L(f) = L_0 + (L_1 - L_0) \left(\frac{f}{F_1} \right)^n,$$

$$n = \frac{\log \left| \frac{L_1}{L_2} \right|}{\log \frac{F_1}{F_2}}$$

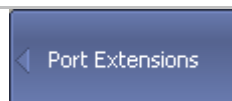

To enable the Port Extension function, use the following softkeys:

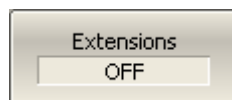

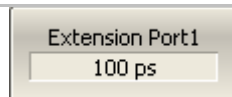

Calibration > Port Extensions > Extensions

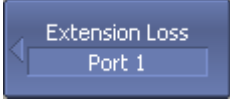
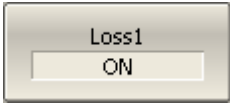
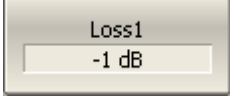

To set the electrical delay for each port, use the following softkey:

Extension Port n

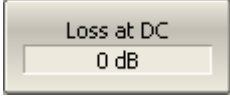
	<p>To open the menu of the losses for each port, click Loss Port n</p>
	<p>Enter the L_1, F_1 values and enable the use of these values in further calculations using the following softkeys:</p>
	<p>Loss 1 [ON OFF]</p>
	<p>Loss1 <Value></p>
	<p>Freq 1 <Value></p>
	<p>Perform the same steps for L_2, F_2</p>
	<p>Enter the L_0 value using the following softkey:</p>
	<p>Loss at DC <Value></p>

5.2.19 Automatic Port Extension

Auto Port Extension function allows for automatic calculation of the parameters for the Port Extension function by measuring a SHORT or OPEN standard. It is possible to measure the both standards. In this case the average value will be used.

The Auto Port Extension function can be used simultaneously for any number of ports from 1 to 4. The user should define the number of ports and connect the SHORT or OPEN standards to the chosen ports.





In the Auto Port Extension function the user should specify the frequency range, which will be accounted in calculations. There are three methods of setting the frequency range:

- Current frequency range;
- User-defined frequency range (within current range);
- User-defined frequency point (selected with a marker).

As the result of the Auto port extension function, the electrical delay value is calculated. This value appears in the corresponding field of the Port Extension function, and Port Extension function turns on, if it was off.

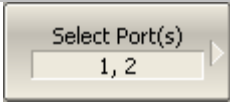
If the option “Include Loss” is enables while Auto Port Extension function is running, the losses values L_1, L_2 and the respective frequency values F_1, F_2 will be calculated and applied. The F_1, F_2 values are calculated as $\frac{1}{4}$ and $\frac{3}{4}$ of the frequency range set by one of the following two methods: current or user-defined. If the frequency range is defined by a marker in a frequency point F_2 is not calculated.

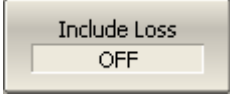
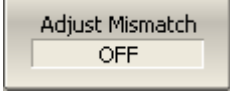
If the “Adjust Mismatch” option is enabled why Auto Port Extension function is running, the frequency-independent loss at DC - L_0 value is set. The value of losses at the lower frequency of the current range is assumed as the L_0 value.

	<p>To open the menu of the Auto Port Extension function, use the following softkeys:</p> <p>Calibration > Port Externsions > Auto Port Externsion</p>
 	<p>Then select the number of ports:</p> <p>Select Port(s)</p> <p>Select the frequency range:</p> <p>Method [Current Span Active Marker User Span]</p>
 	<p>Enable the Include Loss function L_1, L_2, if required:</p> <p>Include Loss [ON OFF]</p> <p>Enable Adjust Mismatch function L_0, if required:</p> <p>Adjust Mismatch [ON OFF]</p>
 	<p>Execute the Auto Port Extension function after connecting SHORT and OPEN to the ports:</p> <p>Measure Short Measure Open</p> <p>If the two functions have been completed, the result will appear as the average value.</p>

5.3 Calibration Kit Management

This section describes how to edit the calibration kit description, add and delete a calibration kit.

The Analyzer provides a table for 50 calibration kits. The first part of the table contains the predefined kits. The second part of the table is for calibration kit added by the user.

A calibration kit redefining can be required for the following purposes:

- To change the port assignment of a standard to ensure connector type (male, female) matching;
- To add a user-defined standard into the kit, e.g. a non zero-length thru;
- To precise the standard parameters to improve the calibration accuracy.

A new user-defined calibration kit adding can be added when a required kit is not included in the list of the predefined kits.

Deleting function is available for user-defined calibration kits only.

Any changes made to the calibration kits are automatically saved into the nonvolatile memory of the Analyzer. For the saving no clicking on a “Save” button is required.

Note	Changes to a predefined calibration kit can be cancelled any time and the initial state will be restored.
------	---

5.3.1 Table of Calibration Kits

The table of calibration kits (See figure 5.15) allows selecting and editing of the calibration kits.

	Label	Description	Select	Predefined	Modified	#STDs	
2	85032B/E	Type-N 50Ω 6GHz Cal Kit (Agilent)	<input type="checkbox"/>	Yes	No	6	▲
3	85032F	Type-N 50Ω 9GHz Cal Kit (Agilent)	<input type="checkbox"/>	Yes	No	8	
4	85054B	Type-N 50Ω 18GHz Cal Kit with Sliding Load (Agilent)	<input type="checkbox"/>	Yes	No	8	
5	85054D	Type-N 50Ω 18GHz Cal Kit (Agilent)	<input type="checkbox"/>	Yes	No	6	
6	05CK10A-150	Type-N 50Ω 18GHz Cal Kit (Rosenberger)	<input type="checkbox"/>	Yes	No	6	
7	8850Q	Type-N 50Ω 18GHz Cal Kit (Maury Microwave)	<input checked="" type="checkbox"/>	Yes	No	6	
8	8850C	Type-N 50Ω 18GHz Cal Kit with Sliding Load (Maury Mic)	<input type="checkbox"/>	Yes	No	8	
9	85033D/E	3.5 mm 6GHz/9GHz Cal Kit (Agilent)	<input type="checkbox"/>	Yes	No	6	
10	85052B	3.5 mm 26.5GHz Cal Kit with Sliding Load (Agilent)	<input type="checkbox"/>	Yes	No	10	▼

Figure 5.15 Table of calibration kits

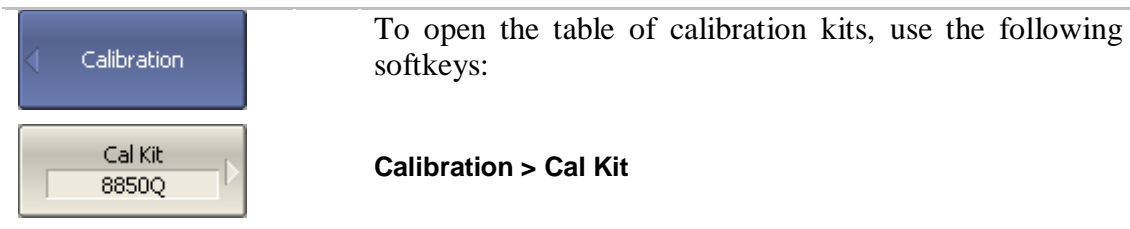

To edit a calibration kit, highlight its line in the table.

The calibration kit editing is comprised of two main procedures: defining of calibration standard (sections 5.3.2 and 5.3.3) and assignment of classes to calibration standards (section 5.3.4). First you need to perform defining of the calibration standards, and then the assignment of classes to them. Defining of calibration standards and assignment of classes to them is performed in different tables.

The label of a calibration kit and its description can be edited in the table of the calibration kits (figure 5.15). The label appears on the calibration menu softkeys. The description is just for information of the user.

The table also contains display-only fields: flags of predefined and modified calibration kits and the counter of the calibration standards in a kit.

5.3.1.1 Calibration Kit Selection for Editing

Move the highlighting to the required line in the calibration kit (See figure 5.15) table using “↑” and “↓” arrows.

Note	The checkmark in the “Select” field does not matter for the kit selection for editing, it selects the calibration kit for calibration.
------	--

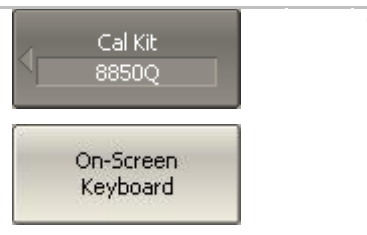

5.3.1.2 Calibration Kit Label and Description Editing

Move the highlighting to the required line in the calibration kit (See figure 5.15) table using “↑” and “↓” arrows and click on the «Enter» softkey. Then enter the new text in the table.

	To activate the on-screen keyboard, click On-Screen Keyboard softkey.
--	--

5.3.1.3 Predefined Calibration Kit Restoration

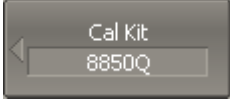

Move the highlighting to the required line in the calibration kit (See figure 5.15).

	<p>To cancel the user changes of a predefined calibration kit, use the following softkeys:</p>
	<p>Restore Cal Kit</p>

<p>Note</p>	<p>It is possible to restore only such calibration kits, whose “Predefined” and “Modified” fields have “Yes” labeling.</p>
-------------	--

5.3.1.4 User-Defined Calibration Kit Deleting

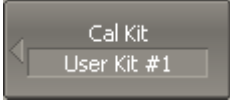
Move the highlighting to the required line in the calibration kit (See figure 5.15).

	<p>To delete a user-defined calibration kit from the table, use the following softkey:</p>
	<p>Erase Cal Kit</p>

<p>Note</p>	<p>It is possible to delete only such calibration kits, whose “Predefined” field have “No” labeling.</p>
-------------	--

5.3.1.5 Calibration Kit Saving to File

Saving of a calibration kit to file is necessary for copying it to a different line of the table or to a different Analyzer.

This command is not necessary for saving of changes made by the user to the definitions of the kit as these changes are saved automatically.

Move the highlighting to the required line in the calibration kit (See figure 5.15).

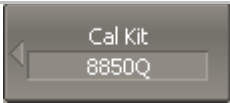
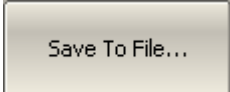
	<p>To save a calibration kit to file, click the following softkey:</p>
	<p>Save to File...</p>

5.3.1.6 Calibration Kit Loading from File

You can load the calibration kit files created by the previous command.

Move the highlighting to the required line in the calibration kit (See figure 5.15).

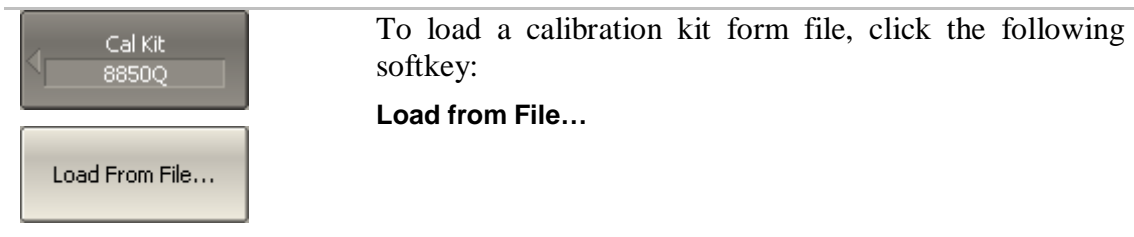

5.3.2 Calibration Standard Definition

The table of the calibration standards (See figure 5.16) includes the full list of the standards in one calibration kit. For the standards defined by the model, the table contains the model parameters. For the data-based standards, the parameters of the model remain blank; S-parameters of such standards are represented in a different table (See section 5.3.3).

	Standard			Frequency		Offset		
	No	Type	Label	Min	Max	Delay	Z0	Loss
▶	1	Open	Open -M-	0 Hz	999 GHz	37.026 ps	50 Ω	700 MΩ/s
	2	Open	Open -F-	0 Hz	999 GHz	19.42 ps	50 Ω	700 MΩ/s
	3	Short	Short -M-	0 Hz	999 GHz	42.063 ps	50 Ω	700 MΩ/s
	4	Short	Short -F-	0 Hz	999 GHz	24.512 ps	50 Ω	700 MΩ/s
	5	Load	Broadband	0 Hz	999 GHz	0 s	50 Ω	0 Ω/s
	6	Thru/Delay	Thru	0 Hz	999 GHz	0 s	50 Ω	700 MΩ/s

Terminal Impedance	$C0 \cdot 10^{-15} F$	$C1 \cdot 10^{-27} F/Hz$	$C2 \cdot 10^{-36} F/Hz^2$	$C3 \cdot 10^{-45} F/Hz^3$
	$L0 \cdot 10^{-12} H$	$L1 \cdot 10^{-24} H/Hz$	$L2 \cdot 10^{-33} H/Hz^2$	$L3 \cdot 10^{-42} H/Hz^3$
	99.14	353.6	62.23	0
	103	0	110	10.2
	0	0	0	0
	0	0	0	0
50 Ω				

Figure 5.16 Calibration standard definition table

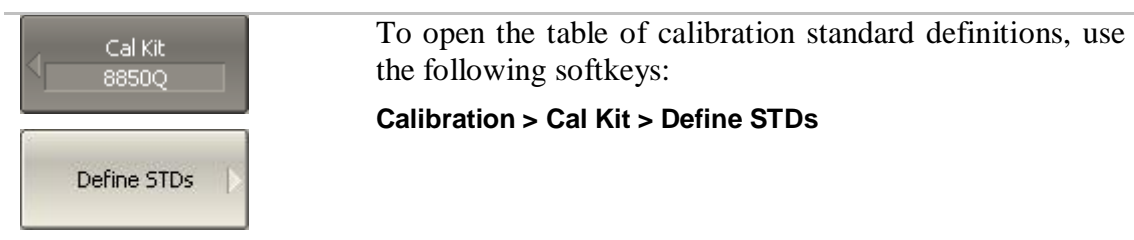

5.3.2.1 Standard Adding to Calibration Kit

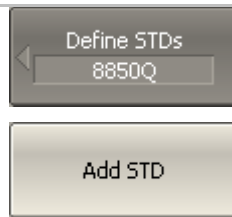

To add a calibration standard to the table of calibration standard definition (See figure 5.16), use the following softkey:

Add STD

5.3.2.2 Standard Deleting from Calibration Kit

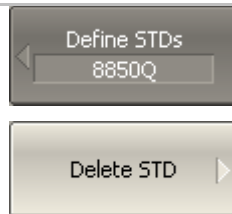

To delete a calibration standard from the table of calibration standard definition (See figure 5.16), use the following softkey:

Delete STD

5.3.2.3 Calibration Standard Editing

Moving in the table of calibration standard definitions (See figure 5.16) using navigation keys, enter the parameter values for a calibration kit:

Standard No.	The calibration standard number is specified in the calibration kit data sheet (just for information).
Standard Type	Select the standard type: <ul style="list-style-type: none"> ▪ Open, ▪ Short, ▪ Load, ▪ Thru/Line, ▪ Unknown Thru, ▪ Sliding Load, ▪ Data-Based
Standard Label	Standard labels specified on the calibration menu softkeys.
Freq. Min.	Lower cutoff frequency of the standard.
Freq. Max.	Upper cutoff frequency of the standard.
Offset Delay	Offset delay value in one direction (s).

Offset Z0	Offset wave impedance value (Ω).
Offset Loss	Offset loss value (Ω/s).
Load Impedance	Lumped load impedance value (Ω).
C0 10^{-15} F	For an OPEN standard, C_0 coefficient in the polynomial formula of the fringe capacitance: $C = C_0 + C_1 f + C_2 f^2 + C_3 f^3$
C1 10^{-27} F/Hz	For an OPEN standard, C_1 coefficient in the polynomial formula of the fringe capacitance.
C2 10^{-36} F/Hz²	For an OPEN standard, C_2 coefficient in the polynomial formula of the fringe capacitance.
C2 10^{-45} F/Hz³	For an OPEN standard, C_3 coefficient in the polynomial formula of the fringe capacitance.
L0 10^{-12} H	For a SHORT standard, L_0 coefficient in the polynomial formula of the residual inductance: $L = L_0 + L_1 f + L_2 f^2 + L_3 f^3$
L1 10^{-24} H/Hz	For a SHORT standard, L_1 coefficient in the polynomial formula of the residual inductance.
L2 10^{-33} H/Hz²	For a SHORT standard, L_2 coefficient in the polynomial formula of the residual inductance.
L2 10^{-42} H/Hz³	For a SHORT standard, L_3 coefficient in the polynomial formula of the residual inductance.

5.3.2.4 Calibration Standard Copy/Paste Function

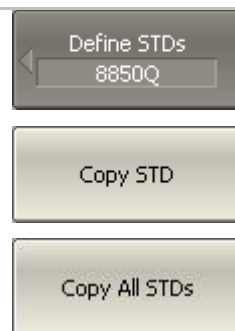

To save a calibration standard into clipboard, highlight the required line in the calibration standard definition table (See figure 5.16) and click the following softkey:



Copy STD

or

Copy All STDs

	To paste the standard(s) from the clipboard, click the following softkey: Paste
---	---

5.3.2.5 Management of Sequence in Standard Table

	To change the sequence in the table, use the following softkeys:
	STD Up
	or
	STD Down

5.3.3 Table of Calibration Standard S-Parameters

The table of calibration standard S-parameters (See figure 5.17) allows viewing and editing of S-parameters of the calibration standards of the “Data-Based” type.

	Frequency	MLog(S11)	Arg(S11)	MLog(S21)	Arg(S21)
1	300 kHz	-67.5270094 dB	53.4023888 °	0.00394846762 dB	0.291495528 °
2	8.2997 MHz	-81.9584188 dB	-119.014476 °	0.00351271886 dB	0.322307311 °
3	16.2994 MHz	-78.8287269 dB	-128.601485 °	0.00322754052 dB	0.320729452 °
4	24.2991 MHz	-76.6945937 dB	-126.226624 °	0.00335760667 dB	0.321443452 °
5	32.2988 MHz	-75.3564463 dB	-123.320088 °	0.00336896915 dB	0.322652352 °
6	40.2985 MHz	-73.9037876 dB	-118.924822 °	0.00352190889 dB	0.325734959 °
7	48.2982 MHz	-72.3276906 dB	-114.247608 °	0.00416283402 dB	0.327349639 °
8	56.2979 MHz	-70.8755884 dB	-109.418739 °	0.00457673931 dB	0.322968328 °
9	64.2976 MHz	-69.1166427 dB	-105.957991 °	0.00452183965 dB	0.316878686 °

Figure 5.17 Table of calibration standard S-parameters

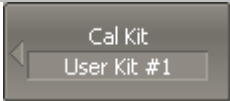
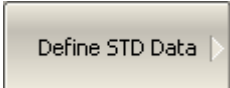
To open the table of calibration standard S-parameters, move the required line in the table (See figure 5.17), and click the following softkeys:

Define STD Data

Note **Define STD Data** softkey is disabled if the type of the standard is other than “Data-Based”.

There are two different tables for one-port standards and for two-port standards. The table contains one parameter (S_{11}) for one-port standards, and four parameters (S_{11} , S_{21} , S_{12} , S_{22}) for two-port standards. Before the user fills in the table, its type will be defined: by the Touchstone format (s1p or s2p) if the data is downloaded from a file, or the user will be requested to specify the type if the data is entered by the user.

The data in the table can be represented in three formats according to the user settings:

- Real part and Imaginary part,
- Linear magnitude and Phase (°),
- Logarithmic magnitude (dB) and Phase (°).

The following rule is applied for the calibration of a two-port standard: the standard is considered connected by port 1 (S_{11}) to the port with smallest number, and by port 2 (S_{22}) to the port with the biggest number. If you need to “reverse” a two-port standard, use the “Port Reverse” function (section 5.3.3.5).

5.3.3.1 Line Adding to Table

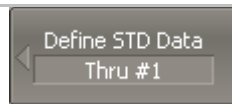

To add a line to the table of the calibration standard S-parameters (See figure 5.17), use the following softkeys:

Add Row

5.3.3.2 Line Deleting from Table

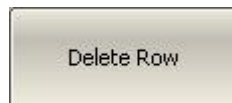
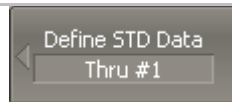

To delete a line from the table of the calibration standard S-parameters (See figure 5.17), use the following softkey:

Delete Line

5.3.3.3 Table Clearing

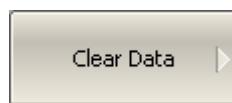

To clear the entire table of the calibration standard S-parameters (See figure 5.17), use the following softkey:

Clear Data

5.3.3.4 Table Format Selecting

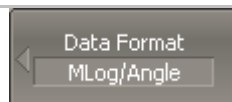

To select the format of the table of the calibration standard S-parameters (See figure 5.17), use the following softkey:

Format > Real/Imag | Magn/Angle | MLog/Angle

5.3.3.5 Port Reversing

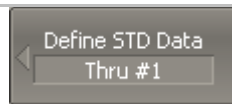

To enable/disable reversing of the ports of a two-port standard, use the following softkey:

Reverse Ports

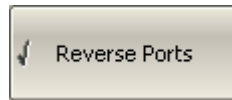

5.3.3.6 Data Loading from File

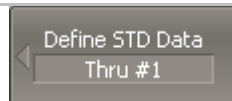

To open the data from Touchstone file, use the following softkey:

Load Data from Touchstone file...

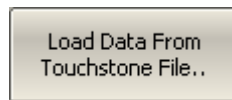

In the pop-up dialog select the file type (s1p or s2p) and specify the file name.

5.3.4 Calibration Standard Class Assignment

The assignment of classes to the standards of the selected calibration kit is made in the table of standard classes (See figure 5.18).

Class	Port	Subclass 1	Subclass 2	Subclass 3	Subclass 4
Open	1	2. Open -F-	8. Open -M-		
	2	2. Open -F-	8. Open -M-		
	3	2. Open -F-	8. Open -M-		
	4	2. Open -F-	8. Open -M-		
Short	1	1. Short -F-	7. Short -M-		
	2	1. Short -F-	7. Short -M-		
	3	1. Short -F-	7. Short -M-		
	4	1. Short -F-	7. Short -M-		
Load	1	3. Broadband			
	2	3. Broadband			
	3	3. Broadband			
	4	3. Broadband			
Thru	1-2	4. Thru	15. Unknown Thru		
	1-3	4. Thru	15. Unknown Thru		
	1-4	4. Thru	15. Unknown Thru		
	2-3	4. Thru	15. Unknown Thru		
	2-4	4. Thru	15. Unknown Thru		
	3-4	4. Thru	15. Unknown Thru		
	1-2				
	1-3				

Figure 5.18 Table of calibration standard classes

Standard labels filled in the table cells by selecting them from the list of calibration kit standards.

Each row of the table corresponds to the standard class specified in the two left columns of the table.

If single standard is assigned to the class then it filled into the "Subclass 1" column. If several standards are assigned to the class then "Subclass 2", "Subclass 3", etc columns are filled in.

Note

When assigning two or more subclasses to one class of calibration standards the calibration menu changes: the standard measurement softkey is replaced by the softkey, which opens the subclass menu containing the list of all the standards of this class.

Using one subclass is appropriate in cases when you know which standard and of which polarity, male or female, is assigned to each port, or when the mathematical models of male and female standards are the same. Using of one subclass simplifies the calibration menu structure.

Using more than one subclass allows to:

- Postpone the selection of standards of the same class available in the calibration kit to the calibration stage. It is possible to select between male and female standards, FLUSH THRU and UNKNOWN THRU.
- Perform the bandsplit calibration as described in section 5.2.13

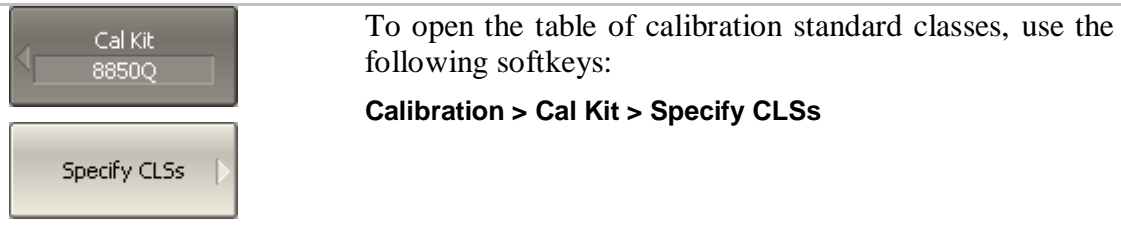

5.3.4.1 Standard Class Table Editing

Moving in the table of calibration standard classes (See figure 5.18) using navigation keys, click «**Enter**» in the required cell for the pop-up menu. Select the standard label in the pop-up menu to assign it the class and port number specified in the left part of the table.

5.3.4.2 Standard Deleting from Standard Class Table

Moving in the table of calibration standard classes (See figure 5.18) using navigation keys, click «**Enter**» in the required cell for the pop-up menu. Select the line **None** in the pop-up menu to delete the standard contained in the cell.

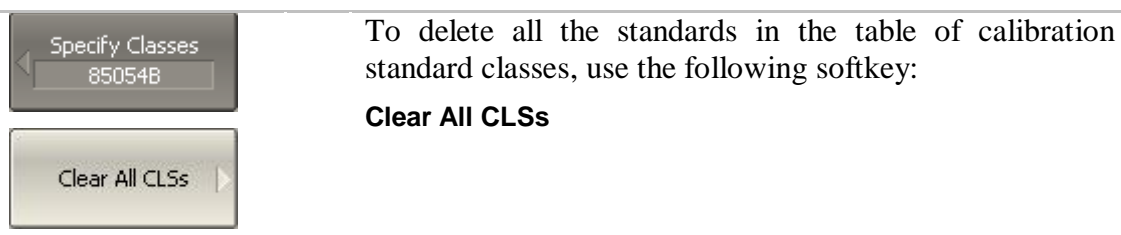

5.3.4.3 Strict Class Assignment Function

This function allows for limitation of the one standard type(s) available in each class by the feature of strict correspondence (See table 5.7). If this function is disabled, any class can be assigned to the standard.

Table 5.7 Standard class and standard type correspondence

N	Standard Class	Standard Type
1	OPEN	<ul style="list-style-type: none"> • Open, • Data-Based (One Port)
2	SHORT	<ul style="list-style-type: none"> • Short, • Data-Based (One Port)
3	LOAD	<ul style="list-style-type: none"> • Load, • Sliding Load, • Data-Based (One Port)
4	THRU	<ul style="list-style-type: none"> • Thru/Line, • Data-Based (Two Port)
5	TRL THRU	<ul style="list-style-type: none"> • Thru/Line, • Data-Based (Two Port)
6	TRL REFLECT	<ul style="list-style-type: none"> • Open, • Short, • Data-Based (One Port)
7	TRL LINE/MATCH	<ul style="list-style-type: none"> • Load, • Thru/Line

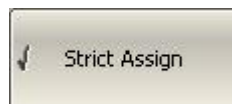
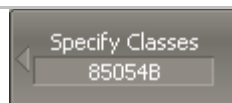

To disable/enable the function of strict class correspondence function, use the following softkey:

Strict Assign

5.3.4.4 Function of Group Assignment of Port Number

This function allows for automatic assignment of one standard to all the ports of a specific class when assigned to at least one port.

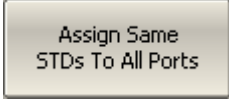
	To enable/disable the function of group assignment of port number, use the following softkey:
	Assign Same STDs to All Ports

5.4 Power Calibration

The Analyzer ensures steady power level at the test port inputs with the specified accuracy. The power level is defined by the user from -60 dBm to $+10$ dBm.

A DUT is connected to the Analyzer by cables, which have some losses. The power calibration allows the user to maintain a more accurate power level at a DUT input, adjusted to the use of the cables.

The power calibration is performed by an external power meter connected to the cables' ends, which will be later connected to the DUT.

After the power calibration is complete, power correction automatically turns on. Later the user can disable or enable again the power correction function.

The power calibration is performed for each port and each channel individually.

Note	The power correction status is indicated in the trace status field (See section 4.2.2) and in the channel status bar (See section 4.2.6).
------	---

5.4.1 Loss Compensation Table

The loss compensation function allows the user to apply compensation for unwanted losses produced between the power meter and the calibrated port in the process of power calibration. Define the losses, which you need to compensate in the table (See figure 5.19) specifying frequency and losses.

	Frequency	Loss
1	300 kHz	0.1 dB
2	1 GHz	0.2 dB
3	2 GHz	0.4 dB
4	3 GHz	0.5 dB
5		

Figure 5.19 Loss compensation table



Linear interpolation will be applied to the losses in the intermediary frequency points.

The loss compensation table is defined for each port individually.

Note	To have the losses compensated for, you need to enable this function and fill out the table before you start the power calibration procedure.
------	---

5.4.2 Power Calibration Procedure

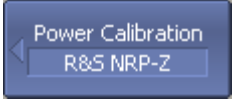
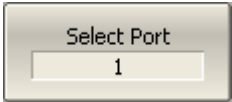
Perform connection and setting of an external power meter as described in section 8.10. Connect the sensor to one of the test ports of the Analyzer and perform calibration as described below. Then repeat the calibration for the other test port.

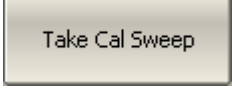

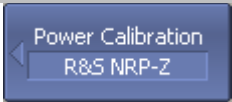
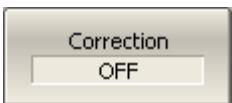

 	<p>To select the calibrated port number, use the following softkeys:</p> <p>Calibration > Power Calibration > Select Port</p>
	<p>To zero power meter, use the following softkeys:</p> <p>Calibration > Power Calibration > Power Sensor Zero Correction</p>
<p>Note</p>	<p>Power meter sensor can be connected to the port, as during zero setting the output signal of the port is turned off.</p>
	<p>To execute power calibration, use the following softkeys:</p> <p>Calibration > Power Calibration > Take Cal Sweep</p>
<p>Note</p>	<p>After the power calibration is complete, power correction automatically turns on.</p>

5.4.3 Power Correction Setting

 	<p>To enable/disable power correction, use the following softkeys:</p> <p>Calibration > Power Calibration > Correction</p>
--	---

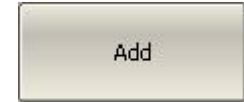
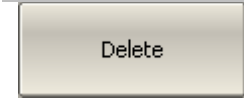
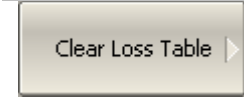
5.4.4 Loss Compensation Table Editing

If you need to apply the loss compensation, enable this function and fill out the table before you start the power calibration procedure. Fill out the table for each port individually.

	<p>To add a new row to the loss compensation table, use the following softkeys:</p>
	<p>Calibration > Power Calibration > Loss Compen > Add</p> <p>A new row will appear under the highlighted one.</p>
	<p>To delete a highlighted row, use the following softkeys:</p> <p>Calibration > Power Calibration > Loss Compen > Delete</p>
	<p>To clear all the table, use the following softkeys:</p> <p>Calibration > Power Calibration > Loss Compen > Clear Loss Table</p>
	<p>To save the table into a *.lct file on the hard, use the following softkeys:</p> <p>Calibration > Power Calibration > Loss Compen > Export Loss Table</p>
	<p>To open the table from a *.lct file from the hard, use the following softkeys:</p> <p>Calibration > Power Calibration > Loss Compen > Import Loss Table</p>
	<p>Enter frequency and loss values into the table, scrolling by navigation keys.</p> <p>To enable the loss compensation function, use the following softkeys:</p> <p>Calibration > Power Calibration > Loss Compen > Compensation</p>

5.5 Receiver Calibration

Receiver calibration is only used for absolute measurements. The receiver calibration is divided into the test receiver (T1, T2, T3, T4) calibration and the reference receiver (R1, R2, R3, R4) calibration. The calibration procedure is different for these receivers.

1. Test receiver calibration

When you perform absolute power measurements (See section 4.7.3), the gain of receivers is factory calibrated to test port on the front panel.

In practice, the power is measured at test port inputs made by the fixture producing losses. The test receiver calibration enables the user to measure the power at port inputs with higher accuracy.

The receiver calibration is performed by sending the calibration signal from the source port to the calibrated port input. The receiver calibration requires the connection between the both test ports using THRU connection.

To make the receiver calibration most accurate, first perform power calibration on the source port. If the source power calibration was not performed, to get good results you need to connect the calibrated port to the source port on the front panel.

2. Reference receiver calibration

Unlike test receivers, the reference receiver measures the output power of its port. Supplying a signal from a different port is meaningless for a reference receiver. That is why the power source in reference receiver calibration is the reference receiver itself, no matter which port is assigned to be a source.

3. General comments

The user can specify the power offset value before calibration. As a result, the receiver readings will be offset by this value.

After the receiver calibration is complete, receiver correction automatically turns on. Later the user can disable or enable again the receiver correction function.

The power calibration is performed for each port and each channel individually.

Note	The power correction status is indicated in the trace status field (See section 4.2.2) and in the channel status bar (See section 4.2.6).
------	---

5.5.1 Receiver Calibration Procedure

Connect a THRU between the receiver port and the source port if test receiver calibration is performed.

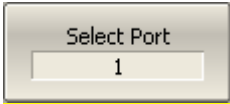
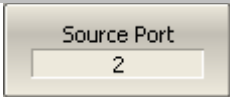
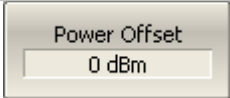
	<p>To select the calibrated port number, use the following softkeys:</p> <p>Calibration > Receiver Calibration > Select Port</p>
	
	<p>To select the source port number, use the following softkeys:</p> <p>Calibration > Receiver Calibration > Source Port</p> <p>Note: Source Port number is valid only for Test Receiver Calibration.</p>
	<p>Set power offset value if needed:</p> <p>Calibration > Receiver Calibration > Power Offset</p>



To execute the test receiver calibration, use the following softkeys:

Calibration > Receiver Calibration > Calibrate Test Receiver

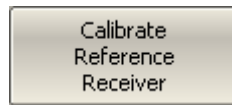

To execute the reference receiver calibration, use the following softkeys:

Calibration > Receiver Calibration > Calibrate Reference Receiver

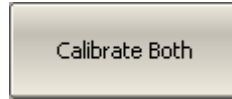

Use the **Calibrate Both** softkey to perform the calibration of the test and reference port receivers in succession.

Note

After the receiver calibration is complete, receiver correction automatically turns on.

5.5.2 Receiver Correction Setting

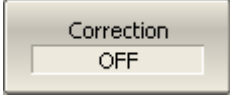
 A blue rectangular softkey with a white left-pointing arrow on the left side and the text "Receiver Calibration" in white.	To enable/disable receiver correction, use the following softkeys:
 A light gray rectangular softkey with a white border and the text "Correction" above "OFF" in black.	Calibration > Receiver Calibration > Correction

5.6 Scalar Mixer Calibration

Scalar mixer calibration is the most accurate method of calibration applied to measurements of mixers in frequency offset mode.

The scalar mixer calibration requires OPEN, SHORT, and LOAD standards as well as external power meter (See Figure 5.20). The power meter connection and setup is described in section 8.8.

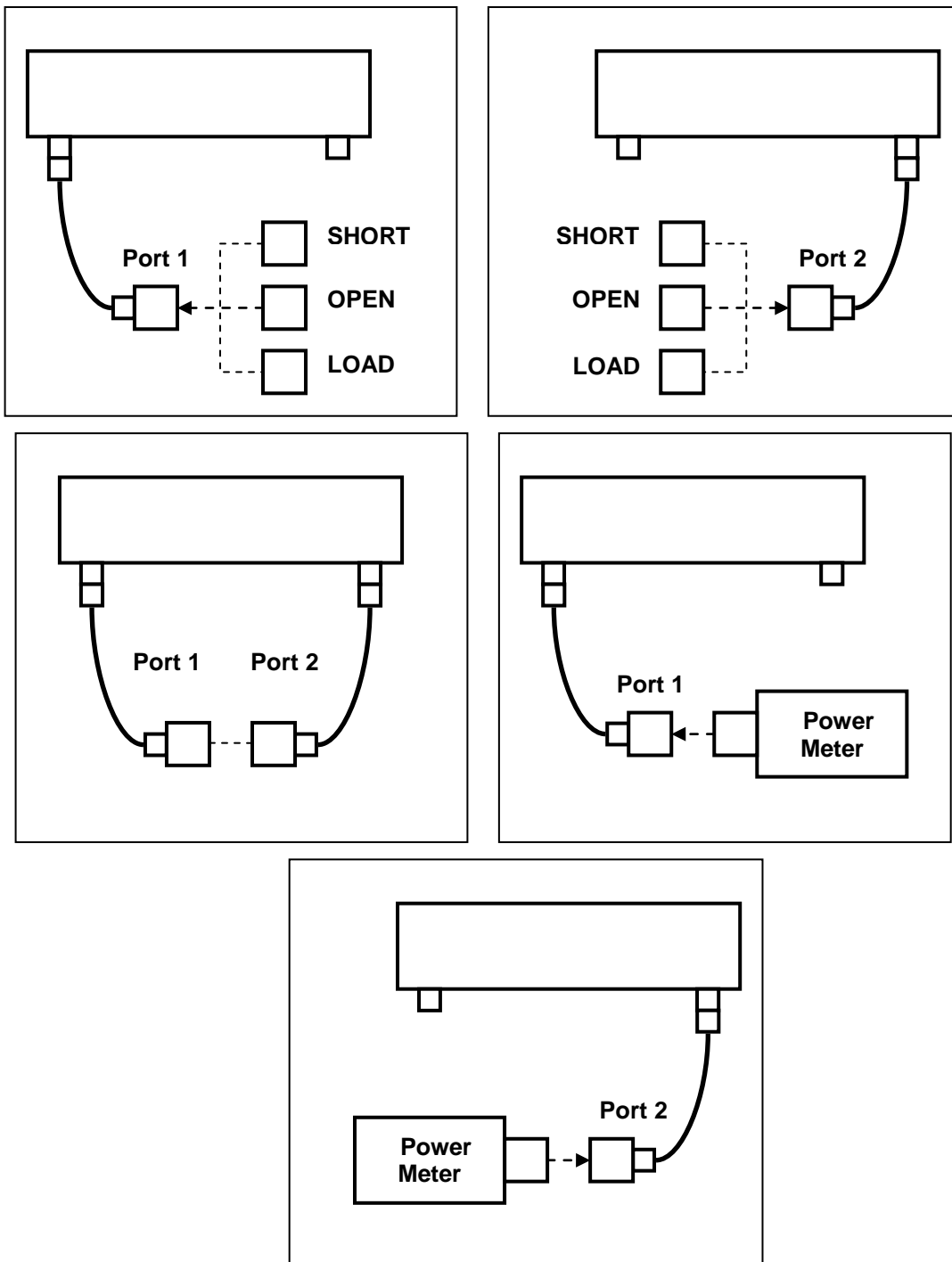

Figure 5.20 Scalar mixer calibration setup

The scalar mixer calibration allows the following measurements:

- reflection S_{11} and S_{22} parameters in vector form;
- transmission S_{21} and S_{12} parameters in scalar form.

The power meter can be connected either one port or both ports. If power meter was connected to port 1 then S_{21} transmission parameter will be calibrated. If power meter was connected to port 2 then S_{12} transmission parameter will be calibrated.

Before you start the calibration, perform the following settings: select active channel and set its parameters (frequency span, IF bandwidth, etc.), and define the calibration kit. Then enable the frequency offset mode and perform the port settings.

Note

The scalar mixer calibration can be performed without frequency offset. You can enable the frequency offset mode later, during mixer measurements. In this case the basic frequency range should cover the frequency range of each port in offset mode. This procedure is convenient but less accurate as involves interpolation.

Scalar mixer calibration procedure.



To access the scalar mixer calibration menu, use the following softkeys:

Calibration > Mixer/Converter Calibration > Scalar Mixer Calibration

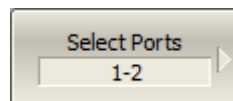

Select port pair using softkey: **Select Ports**

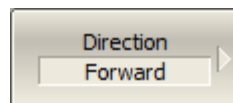

Select calibration direction using softkey: **Direction > {Forward | Reverse | Both }**

Direction means the transmission direction to be calibrated. Direction determines the power meter connection port or both ports.

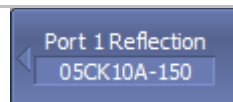

Click **Reflection Port n** softkey.

Connect SHORT, OPEN and LOAD standards to Port 1 as shown in Figure 5.20. Perform measurements for each standard using the respective standard softkeys.

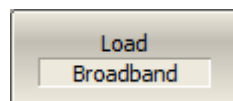
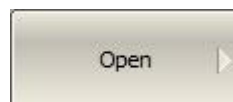

The instrument status bar will indicate **Calibration in progress...** when the measurement is in progress. On completion of the measurement, a check mark will appear in the left part of the softkey.

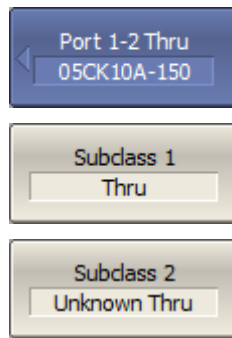

Connect a THRU standard between the test ports.

Click **Thru** button if you use a flush thru or if you use non zero thru and have it strictly defined in the calibration kit definition.

Click **Unknown Thru** button if you use a non zero thru and don't have it definition.

The instrument status bar will indicate **Calibration in progress...** when the measurement is in progress. On completion of the measurement, a check mark will appear in the left part of the softkey.

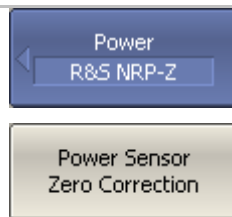

Click **Power** softkey.

If needed, zero power meter using **Power Sensor Zero Correction** softkey.

Note

Power meter sensor can be connected to the port, as during zero setting the output signal of the port is turned off.

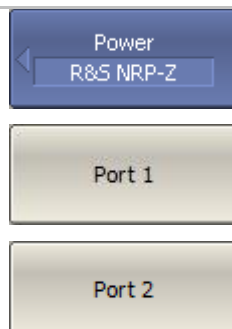

Connect the power meter to Port n and click corresponding softkey.

The instrument status bar will indicate **Calibration in progress...** when the measurement is in progress. On completion of the measurement, a check mark will appear in the left part of the softkey.



To complete the calibration procedure, click **Apply**.

This will activate the process of calibration coefficient table calculation and saving it into the memory. The error correction function will also be automatically enabled.



To clear the measurement results of the standards, click **Cancel**.

This softkey does not cancel the current calibration. To disable the current calibration turn off the error correction function.

Note You can check the calibration status in channel status bar (See Table 5.5) or in trace status field (See Table 5.6) – **SMC** label.

5.7 Vector Mixer Calibration

Vector scalar calibration is a calibration method applied for mixer measurements. This method allows measurement of both reflection and transmission S-parameters in vector form, including phase and group delay of transmission coefficient.

The vector mixer measurements require an additional mixer with filter, which is called calibration mixer.

The filter separates the IF, which is the input frequency for the mixer under test:

- $RF + LO$
- $RF - LO$
- $LO - RF$

Both calibration mixer and mixer under test are powered from one LO.

The vector mixer measurement is a combination of a 2-port calibration and a de-embedding function (See Figure 5.21).

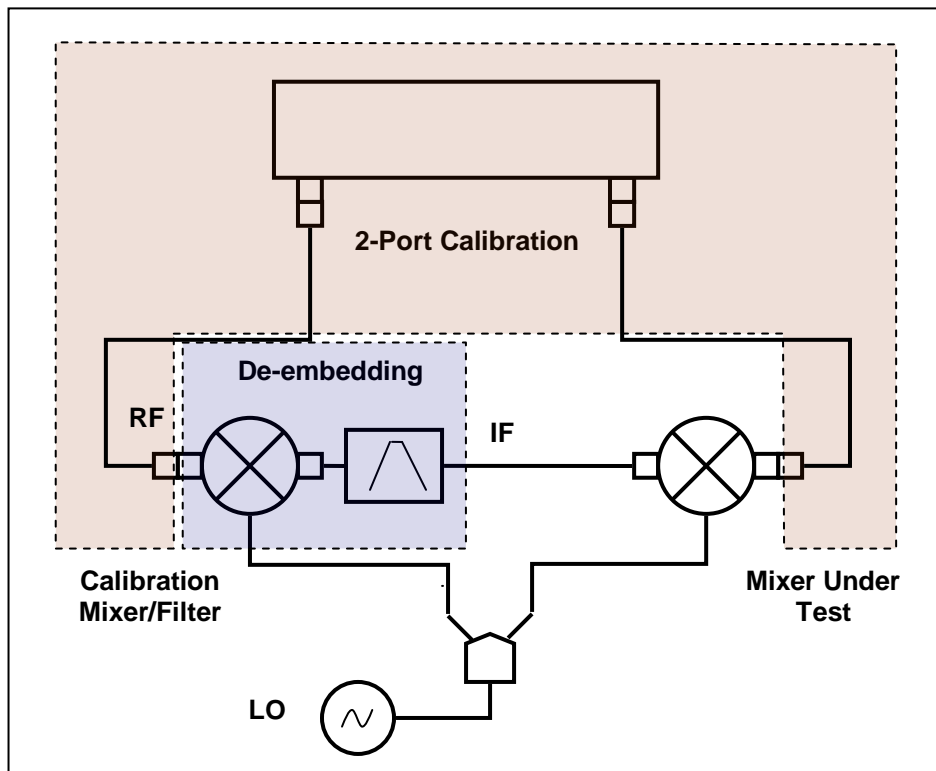

Figure 5.211 Vector mixer measurements

The de-embedding function requires an S-parameter file of the circuit. Acquisition of such a file for the calibration mixer/filter pair is called vector mixer calibration.

To obtain an S-parameter file of the calibration mixer/filter, you need to use SHORT, OPEN, and LOAD calibration standards (See Figure 5.22).

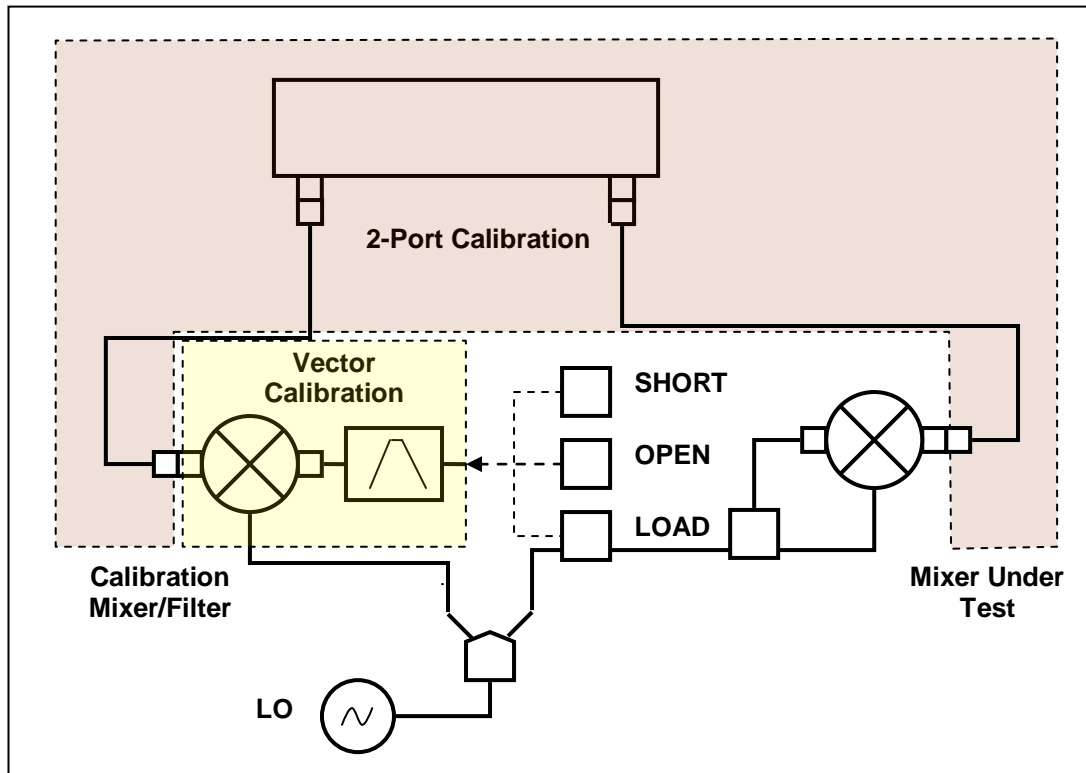

Figure 5.22 Vector Mixer Calibration

5.7.1 Vector Mixer Calibration Procedure







Before you start the calibration, perform the following settings: activate a channel and set its parameters (frequency span, IF bandwidth, etc.), and define the calibration kit.

- Perform 2-port calibration.
- Assemble vector calibration setup.
- Set frequency and power of the external LO.

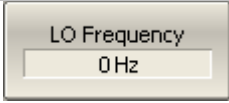
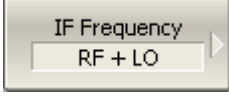

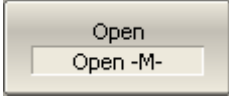
To access the vector mixer calibration menu, use the following softkeys:

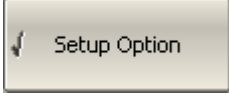
Calibration > Mixer/Converter Calibration > Vector Mixer Calibration

	<p>To select the number of test port connected to the calibration mixer, click Select Port.</p>
	<p>Enter the LO frequency, using LO Frequency softkey.</p>
	<p>Select the frequency to be separated by the filter, using IF Frequency softkey:</p> <ul style="list-style-type: none"> ▪ RF + LO ▪ RF – LO ▪ LO – RF
	<p>Connect SHORT, OPEN and LOAD standards to IF filter output as shown in Figure 5.22. Perform the measurement using the respective standard softkey.</p> <p>The instrument status bar will indicate Calibration in progress... when the measurement is in progress. On completion of the measurement, a check mark will appear in the left part of the softkey.</p>
	
	
	<p>To complete the calibration procedure, click Save To Touchstone File.</p>
	<p>This will activate calculation of the calibration mixer/filter pair S-parameters, and saving those into a Touchstone file. Enter the file name in the pop-up dialog.</p> <p>If Setup Option feature is enabled, S-parameter file will be passed to the de-embedding function and this function will be activated.</p>
<p>Note</p>	<p>You can check the calibration status in channel status bar (See 5.6) – F2 and Dmb labels (2-port calibration and de-embedding function).</p>

5.8 Automatic Calibration Module

Automatic calibration module (ACM) is a special device, which allows for automating of the process of calibration. ACM is shown in figure 5.23.



Figure 5.23 Automatic Calibration Module

ACM offers the following advantages over the traditional SOLT calibration, which uses a mechanical calibration kit:

- Reduces the number of connections of standards. Instead of connecting seven standards, it requires connecting only two ACM connectors;
- Reduces the calibration time;
- Reduces human error probability;
- Provides higher accuracy potentially.

ACM has two RF connectors for connection to the Analyzer test ports and a USB connector for control. ACM contains electronic switches, which switch between different reflection and transmission impedance states, as well as memory, which stores precise S-parameters of these impedance states.

After you connect the ACM to the Analyzer, the Analyzer software performs the calibration procedure automatically, i.e. switches between different ACM states, measures them, and computes calibration coefficients using the data stored in the ACM memory.

5.8.1 Automatic Calibration Module Features

Calibration Types:

ACM allows the Analyzer software to perform full two-port or full one-port calibrations with the click of a button. 3/4-port calibration can be performed with a minimal number of reconnections. We recommend that you terminate the unusable ACM port with a load while performing one-port calibration.

Characterization:

Characterization is a table of S-parameters of all the states of the ACM switches, stored in the ACM memory. There are two types of characterization: user characterization and factory characterization. ACM has two memory sections. The first one is write-protected and contains factory characterization. The second memory section allows you to store up to three user characterizations. Before calibration you can select the factory characterization or any of the user characterizations stored in the ACM memory. The user characterization option is provided for saving new S-parameters of the ACM after connecting adapters to the ACM ports.

The software enables you to perform a user characterization and save the data to ACM with the click of a button. To be able to do this, you should first calibrate the Analyzer test ports in configuration compatible with the ACM ports.

Automatic Orientation:

Orientation means relating the ACM ports to the test ports of the Analyzer. While the Analyzer test ports are indicated by numbers, the ACM ports are indicated by letters A and B.

Orientation is defined either manually by the user, or automatically. The user is to select the manual or automatic orientation method. In case of automatic orientation, the Analyzer software determines the ACM orientation each time prior to its calibration or characterization.

Unknown Thru:

The Thru implemented by the electronic switches inside the ACM introduces losses. That is why you should know the exact parameters of the Thru or use an Unknown Thru algorithm to achieve the specified calibration accuracy.

The software allows using the both options. ACM memory stores S-parameters of the Thru, which are used to compute calibration coefficients. In case if an Unknown Thru algorithm is applied, such parameters are disregarded.

Thermal Compensation:

The most accurate calibration can be achieved if the ACM temperature is equal to the temperature, at which it was characterized. When this temperature changes, certain ACM state parameters may deviate from the parameters stored in the memory. This results in reduction of the ACM calibration accuracy.

To compensate for the thermal error, the ACM features thermal compensation function. Thermal compensation is a software function of the ACM S-parameter correction based on its temperature dependence and the data from the temperature sensor inside the ACM. The temperature dependence of each ACM is determined at the factory and saved into its memory.

The function of thermal compensation can be enabled or disabled by the user.

Confidence Check:

ACM also implements an additional state – an attenuator, which is not used in calibration. The attenuator is used to check the current calibration performed by ACM or any other method. Such test is called a confidence check.

The confidence check consists in simultaneous display of the measured and stored in memory S-parameters of the attenuator. The measured parameters are shown as the data trace and the parameters saved in the ACM memory are shown as the memory trace. You can compare the two traces, evaluate their differences and determine the accuracy of the calibration performed.



For a detailed comparison you can use the math (division) function for data and memory.

5.8.2 1-Port and 2-Port Automatic Calibration Procedure

Before calibrating the Analyzer with ACM, perform some settings, i.e. activate a channel and set channel parameters (frequency range, IF bandwidth, etc).

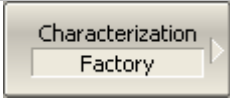
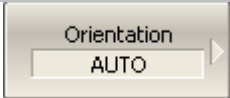
Connect the ACM to the Analyzer test ports, and connect the USB port of the ACM to the USB port of the computer.

	<p>To start automatic calibration, use the following softkeys:</p> <p>Calibration > AutoCal</p>
	<p>Select characterization using Characterization softkey.</p>
	<p>Select manual or automatic orientation of the ACM using Orientation softkey.</p> <p>It is recommended to select AUTO orientation.</p>

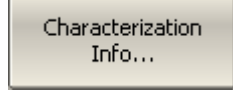
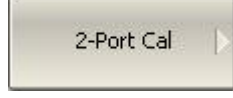
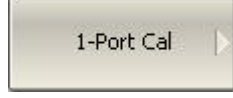
	<p>Enable or disable Unknown Thru algorithm using Unkn. Thru softkey.</p>
	<p>Enable or disable the thermal compensation using Thermal Compensation softkey.</p>
	<p>To display detailed information on characterization, use Characterization Info softkey.</p>
	<p>To perform full two-port calibration, use 2-Port AutoCal softkey. Then select the port pair number.</p>
	<p>To perform full one-port calibration, use 1-Port AutoCal softkey. Then select the port number.</p>

5.8.3 3-Port Calibration with 2-Port ACM

3-port calibration can be performed with a two-port ACM as follows.

- Full enumeration method of calibration requires three ACM connections between three pairs of ports. For example, for calibration of ports 1-2-3 you need to make three ACM connections between ports 1-2, 1-3 and 2-3.
- Simplified calibration requires two ACM connections between two pairs of ports. For example, for calibration of ports 1-2-3 you need to make two ACM connections between any pairs of ports, for example 1-2 and 1-3.

The 3-port ACM calibration allows for optional measurement of external thru for accuracy improvement. The maximum accuracy improvement is achieved by the external thru in the simplified 3-port ACM calibration between the pair of ports which were not connected to the ACM. In case the external thru connection is the same as the ACM connection, then the external thru measurement is used for calculation instead of the internal ACM thru state (See section 5.6.5).

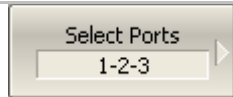
	<p>To start automatic 3-Port calibration, use the following softkeys: Calibration > AutoCal > 3-Port Cal</p>
	<p>Select the three ports to be calibrated using Select Ports softkey.</p>

1-2 AutoCal	For the 3 pairs of ports (or for 2 pairs in case of the simplified calibration) repeat the following:
1-3 AutoCal	Connect the ACM between the test ports. Perform measurement using n–m AutoCal softkey.
2-3 AutoCal	
1-2 Thru (Optional) ▶	To improve the calibration accuracy, perform the optional external thru measurements.
1-3 Thru (Optional) ▶	Connect a THRU standard between the test ports. Perform measurement using n–m Thru (Optional) softkey, then select the THRU type. If the port connectors allow direct connection (zero electrical length thru) use Flush Thru softkey, otherwise Unknown Thru softkey.
2-3 Thru (Optional) ▶	
Apply	
Cancel ▶	To clear the measurement results of the standards, click Cancel. This softkey does not cancel the current calibration. To disable the current calibration, disable the error correction function (See section 5.2.10).
Note	You can check the calibration status on the channel status bar (See table 5.5) or in the trace status field (See table 5.6).

5.8.4 4-Port Calibration with 2-Port ACM





A 4-port calibration can be performed with a 2-port ACM as follows.

1. Full enumeration method of calibration requires six ACM connections between all pairs of ports: 1-2, 1-3, 1-4, 2-3, 2-4 and 3-4.
2. Simplified 4-port calibration using a 2-port ACM has two types:
 - The simplified 4-port ACM calibration I includes three or more ACM connections. Minimum three ACM connections are required for star connection patterns with one common port, for example, 1-2, 1-3 and 1-4. For other connection patterns, minimum four ACM connections are required.
 - The simplified 4-port ACM calibration II includes two ACM connections and two external thru measurements. ACM connections are performed for non-adjacent port pairs, for example, 1-2 and 3-4. The external thru measurements are performed for the rest port pairs, for example, 1-3 and 1-4. Minimum two thru measurements are required, and up to four thru measurements are possible for improving the calibration reliability.

The 4-port ACM calibration allows for optional measurement of external thru for accuracy improvement. The maximum accuracy improvement is achieved by the external thru in the simplified 4-port ACM calibration between the pair of ports which were not connected to the ACM. In case the external thru connection is the same as the ACM connection, then the external thru measurement is used for calculation instead of the internal ACM thru state (See section 5.6.5).

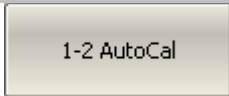
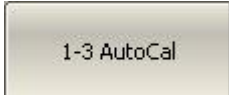
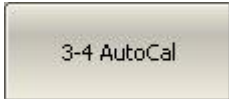
Note

The simplified 4-port ACM calibration II requires two external thru measurements for the pair of ports which were not connected to the ACM. Beyond that, further external thru measurements serve to improve calibration accuracy as described above.

	<p>To start automatic 4-port calibration, use the following softkeys:</p> <p>Calibration > AutoCal > 4-Port Cal</p>
  <p>...</p> 	<p>To start ACM measurement, click AutoCal.</p> <p>To perform the calibration using full set of standards, make 6 ACM measurements.;</p> <p>To perform the simplified calibration I, make three ACM measurements with one common port.</p> <p>To perform simplified calibration II, make two ACM measurements of two nonadjacent port pairs.</p> <p>Upon completion of the two or three measurements, the label on the remaining softkey changes to Optional, what indicates that for simplified calibration a sufficient number of measurements have been performed.</p>
  <p>...</p> 	<p>To start the external thru measurements, click Thru.</p> <p>These measurements are optional for the full enumeration calibration method and for the simplified calibration I.</p> <p>Two external thru measurements of the pairs of ports, which were not connected to the ACM, are required for the simplified calibration II.</p> <p>Select the pair of ports, then select the external thru type using the following softkeys:</p> <p>n-m Thru > [Flush Thru Unknown Thru]</p>
	<p>To complete the calibration procedure, click Apply.</p> <p>This will activate the process of calibration coefficient table calculation and saving it into the memory. The error correction function will also be automatically enabled.</p>



To clear the measurement results of the standards, click **Cancel**.

This softkey does not cancel the current calibration. To disable the current calibration, turn off the error correction function (See section 5.2.10).

Note

You can check the calibration status in channel status bar (See table 5.5) or in trace status field (See table 5.6).

5.8.5 Using External Thru Instead of Internal ACM Thru

Internal ACM thru state involves losses, which introduce small error in Et and EL error terms calculation. Using external thru instead of internal ACM thru allows improving calibration accuracy providing the high-quality low-loss thru is used.

If an external thru is measured during the 3/4-port ACM calibration for the same pairs of ports which were ACM calibrated, then an external thru will be used instead of the internal ACM thru state for calculation.

Note

An external thru is also used in 4-port calibration for execution of simplified calibration, in case it connects the pairs of ports which were not ACM calibrated.

Two types of the thru, FLUSH THRU and UNKNOWN THRU, can be used. The thru type is selected by the user in process of calibration, in this case there is no need to define a thru as a standard of any calibration kit. If the port connectors allow for their direct connection, select the FLUSH THRU, in other case - the UNKNOWN THRU.

5.8.6 User Characterization Procedure



User characterization of ACM is required in case of ACM connectors modification by the use of adapters. The characterization is performed for the new ACM configuration, which includes adapters. To ensure calibration accuracy it is not recommended to disconnect and reconnect the adapters back.

Before you perform the user characterization of the ACM, perform full two-port calibration of the Analyzer in configuration of the test ports compatible with the configuration of ACM ports.

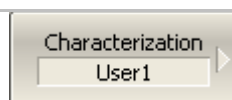
Connect the ACM to the Analyzer test ports, and connect the USB port of the ACM to the USB port of the computer.

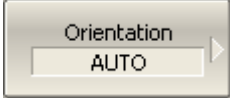

Select user characterization 1 to 3 using **Characterization** softkey.

	<p>Select manual or automatic orientation of the ACM using Orientation softkey.</p> <p>It is recommended to select AUTO orientation.</p>
	<p>Perform characterization using Characterize AutoCal Module softkey.</p>

After the ACM measurement is completed, the following dialog box will appear:

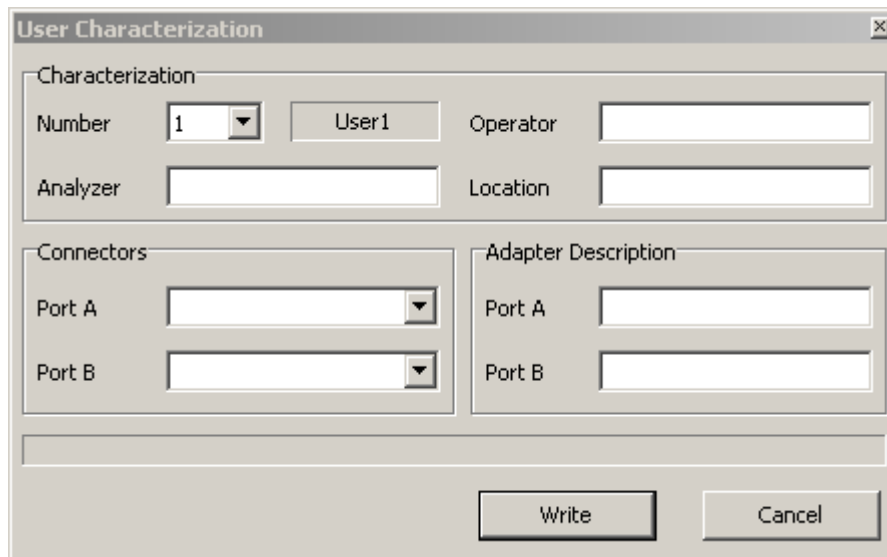

The dialog box titled "User Characterization" contains the following fields:

- Characterization** section:
 - Number: dropdown menu with "1" selected
 - User: text field with "User1" entered
 - Operator: empty text field
 - Analyzer: empty text field
 - Location: empty text field
- Connectors** section:
 - Port A: dropdown menu
 - Port B: dropdown menu
- Adapter Description** section:
 - Port A: empty text field
 - Port B: empty text field

At the bottom of the dialog are "Write" and "Cancel" buttons.

Fill in the following fields:

- User name;
- Analyzer name;
- Characterization location;
- Connectors (types of adapter connectors);
- Adapter description (description of adapters).

Use **Save** softkey to complete the user characterization of the ACM.

5.8.7 Confidence Check Procedure

In case you need to verify the reliability of the current calibration, perform the confidence check. This function can be used to check the accuracy of either calibration performed with an ACM or with a mechanical calibration kit.

Connect the ACM to the Analyzer test ports, and connect the USB port of the ACM to the USB port of the computer.

Enable the display of the data trace for the needed parameter, for example S_{21} . It is possible to enable several data traces simultaneously. It is important that all S-parameters referred to no more than two ports, for example, the S_{11} , S_{22} , S_{21} , S_{12} set of parameters is correct, and the S_{21} , S_{31} set of parameters is not correct.

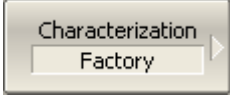
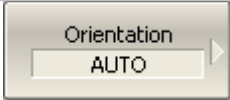
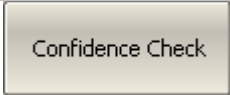
	Select characterization using Characterization softkey.
	Select manual or automatic orientation of the ACM using Orientation softkey. It is recommended to select AUTO orientation.
	Perform confidence check using Confidence Check softkey.

After the measurement is completed, two traces for each S-parameter will be displayed. The measured parameters will be shown as the data trace, and the ACM parameters will be shown as the memory trace.

Compare the data trace and the memory trace of the same parameter, for example S_{21} . To perform more accurate comparison, enable the function of math operations between data and memory traces. In the logarithmic magnitude or phase format use the Data / Memory operation. In the linear magnitude format use the Data – Memory operation.

The conclusion on whether the current calibration provides sufficient accuracy or not is made by the user.

6 MEASUREMENT DATA ANALYSIS

6.1 Markers

A marker is a tool for numerical readout of a stimulus value and value of the measured parameter in a specific point on the trace. You can activate up to 16 markers on each trace. See a trace with two markers in figure 6.1.

The markers allow the user to perform the following tasks:

- Reading absolute values of a stimulus and a measured parameter in selected points on the trace;
- Reading relative values of a stimulus and a measured parameter related to the reference point;
- Search for specific points on the trace (minimum, maximum, target level, etc);
- Determining trace parameters (statistics, bandwidth, etc);
- Editing stimulus parameters using markers.

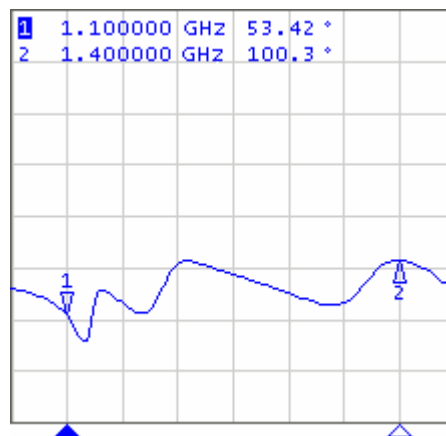

Figure 6.1

Markers can have the following indicators:

1 ▽	symbol and number of the active marker on a trace,
△ 2	symbol and number of the inactive marker on a trace,
▲	symbol of the active marker on a stimulus axis,
△	symbol of the inactive marker on a stimulus axis.

The marker data field contains the marker number, stimulus value, and the measured parameter value. The number of the active marker is highlighted in inverse color.

The marker data field contents vary depending on the display format (rectangular or circular).

- In rectangular format, the marker shows the measurement parameter value plotted along Y-axis in the active format (See table 4.8).
- In circular format, the marker shows two or three values listed in table 6.1

Table 6.1 Marker readings in circular formats

Label	Marker Readings (Measurement Unit)		
	Reading 1	Reading 2	Reading 3
Smith (Lin)	Linear magnitude	Phase (°)	–
Smith (Log)	Logarithmic magnitude (dB)	Phase (°)	–
Smith (Re/Im)	Real part	Imaginary part	–
Smith (R + jX)	Resistance (Ω)	Reactance (Ω)	Equivalent capacitance or inductance (F/H)
Smith (G + jB)	Conductance (S)	Susceptance (S)	Equivalent capacitance or inductance (F/H)
Polar (Lin)	Linear magnitude	Phase (°)	–
Polar (Log)	Logarithmic magnitude (dB)	Phase (°)	–
Polar (Re/Im)	Real part	Imaginary part	–

6.1.1 Marker Adding



To enable a new marker, use the following softkeys:

Markers > Add Marker

Note

The new marker appears as the active marker in the middle of the stimulus axis. The marker stimulus value entry field activates.

6.1.2 Marker Deleting

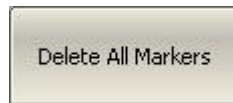

To delete a marker, use the following softkeys:

Markers > Delete Marker

To delete all the markers, use the following softkeys:

Markers > Delete All Markers

6.1.3 Marker Stimulus Value Setting

Before you set the marker stimulus value, you need to select the active marker. You can set the stimulus value by entering the numerical value from the keyboard, by arrows, or by dragging the marker using the mouse, or enabling the search function. Drag-and-drop operation is described in section 4.3.12. Marker search function is described in section 6.1.7.

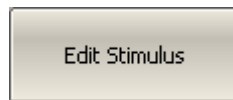

To set the marker stimulus value, use the following softkeys:

Markers > Edit Stimulus

or make a mouse click on the stimulus value field.

Then enter the value using the numerical keys on the keypad, by «↑», «↓» arrows.

6.1.4 Marker Activating

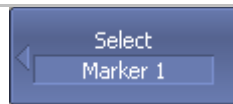

To activate a marker by its number, use the following softkeys:

Markers > Select > Marker n



...



To activate a marker from the list of markers, use the following softkeys:

Markers > Select Next

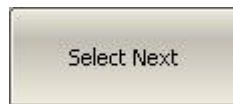

Note

You can activate a marker by making a mouse click on it.

6.1.5 Reference Marker Feature

Reference marker feature allows the user to view the data relative to the reference marker. Other marker readings are represented as delta relative to the reference marker. The reference marker shows the absolute data. The reference marker is indicated with Δ symbol instead of a number (See figure 6.2). Enabling of a reference marker turns all the other markers to relative display mode.

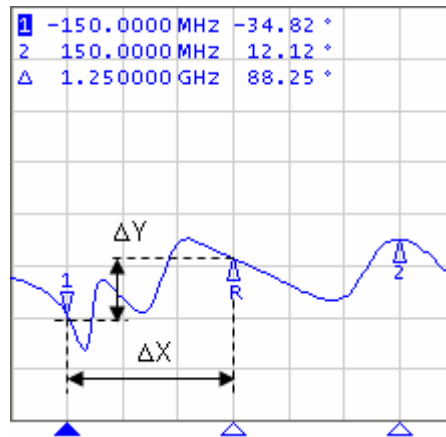

Figure 6.2

Reference marker can be indicated on the trace as follows:

R	symbol of the active reference marker on a trace;
∇	
Δ	symbol of the inactive reference marker on a trace.
R	

The reference marker displays the stimulus and measurement absolute values. All the rest of the markers display the relative values:

- stimulus value — difference between the absolute stimulus values of this marker and the reference marker;
- measured value — difference between the absolute measurement values of this marker and the reference marker.



To enable/disable the reference marker, use the following softkeys:

Markers > Reference Marker

6.1.6 Marker Properties

6.1.6.1 Marker Coupling Feature

The marker coupling feature enables/disables dependence of the markers of the same numbers on different traces. If the feature is turned on, the coupled markers (markers with same numbers) will move along X-axis synchronously on all the traces. If the coupling feature is off, the position of the markers with same numbers along X-axis will be independent (See figure 6.3).

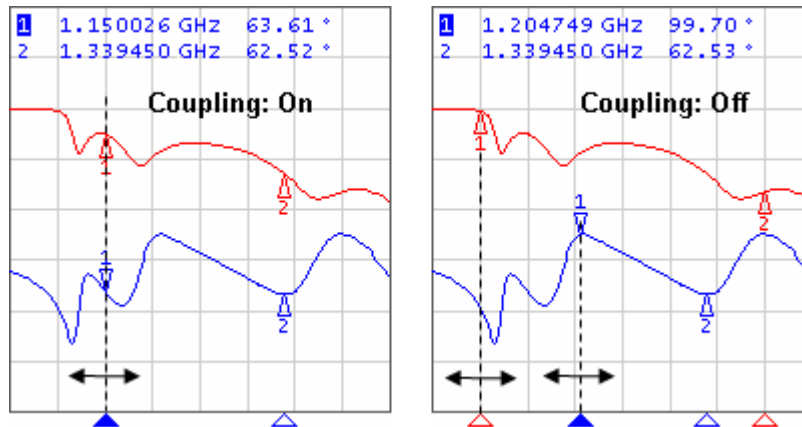
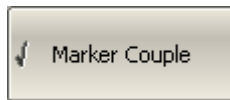

Figure 6.3 Marker coupling feature



To enable/disable the marker coupling feature, use the following softkeys:

Markers > Properties > Marker Couple

6.1.6.2 Marker Table

The marker table enables you to view the values of the markers of all the traces and all the channels (See figure 6.4).

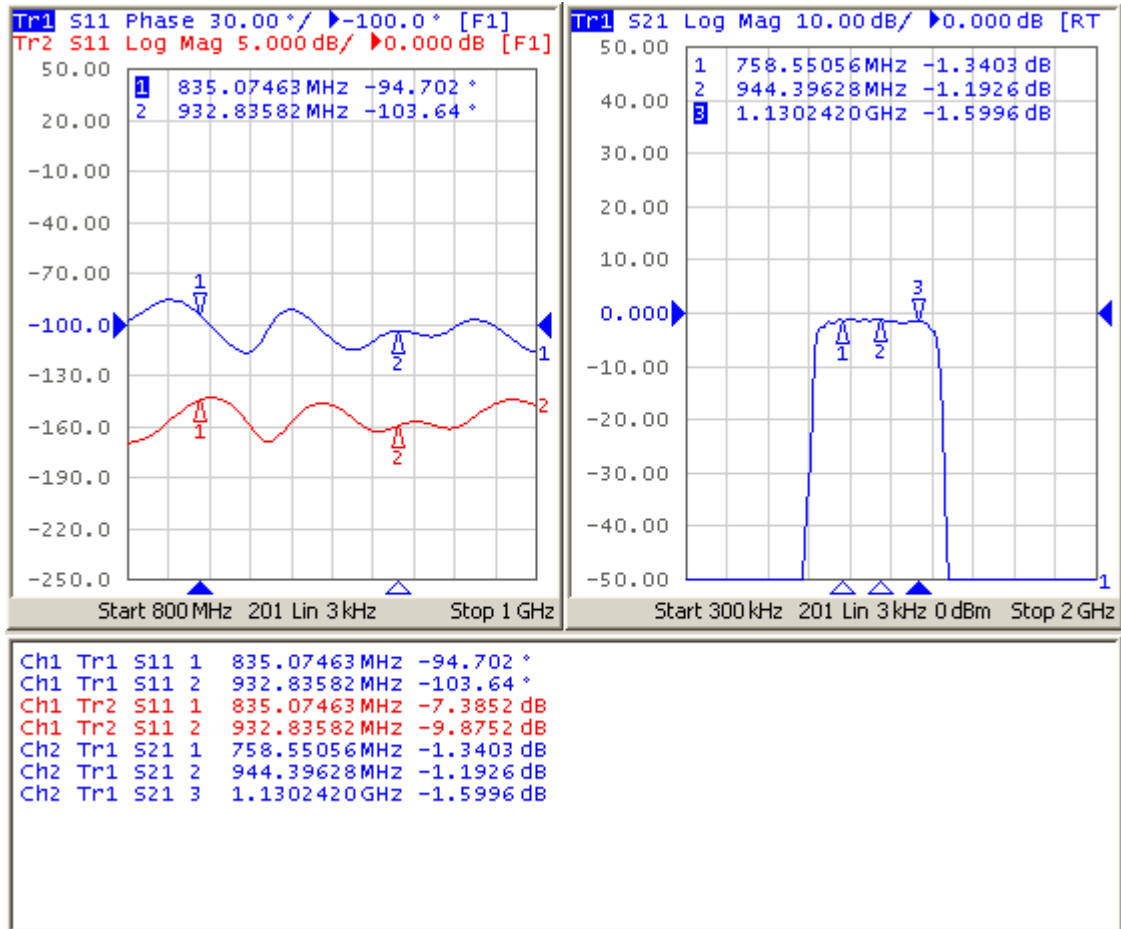

Figure 6.4 Marker table



To show/hide the marker table, use the following softkeys:

Markers > Properties > Marker Table



6.1.6.3 Marker Value Indication Capacity

By default, the marker stimulus values are displayed with 8 decimal digits and marker response values are displayed with 5 decimal digits. The user can change these settings.

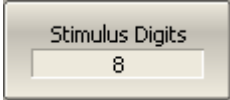
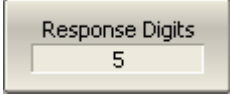
	<p>To set the marker value indication capacity, use the following softkeys:</p>
	<p>Markers > Properties > Stimulus Digits</p>
	<p>Markers > Properties > Response Digits</p>

6.1.6.4 Multi Marker Data Display

If several overlapping traces are displayed in one graph, by default only active marker data are displayed on the screen. The user can enable display of the marker data of all the traces simultaneously. The markers of different traces will be distinguished by the color. Each marker will have same color with its trace.

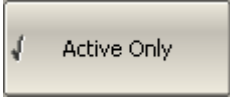
	<p>To enable/disable the multi marker data display, toggle the softkey:</p>
	<p>Markers > Marker Properties > Active Only</p>

Note

When multi marker data display is enabled, to avoid data overlapping on the screen, arrange the marker data on the screen (See section 6.1.6.5).

6.1.6.5 Marker Data Arranging

By default, the marker data are displayed in the upper left corner of the screen. The user can rearrange the marker data display on the screen. The marker data position on the screen is described by two parameters: relative position on the X and Y axes, in percent. Zero percent is upper left corner, 100% is lower right corner. Marker data position for each trace is set separately. This allows the user to avoid data overlapping on the screen.

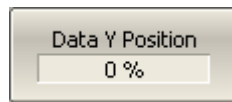
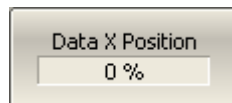
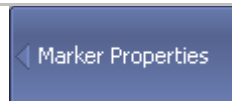

To arrange the marker data on the screen, enter the relative position on the X and Y axes, using the following softkeys:

Markers > Marker Properties > Data X Position

Markers > Marker Properties > Data Y Position

Note

You can also drag-and-drop the marker data by the mouse.

6.1.6.6 Marker Data Alignment

By default, the marker data are displayed independently for each trace. The user can align the marker data display on the screen. The alignment deactivates the independent marker data layout. In this case, the relative position on the X and Y axes is valid only for the first trace. The marker data of the other traces become aligned relatively to the first trace. Two types of alignment are available:

- Vertical – marker data of different traces are displayed one under another;
- Horizontal – marker data of different traces are displayed in line.

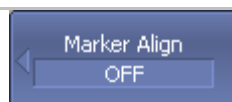

To set the marker data alignment, use the following softkeys:

Markers > Marker Properties > Align >

Vertical | Horizontal | OFF

6.1.6.7 Memory Trace Value Display

By default, the marker values of the data traces (not memory traces) are displayed on the screen. The user can enable the display of memory trace maker values, if a memory trace is available.

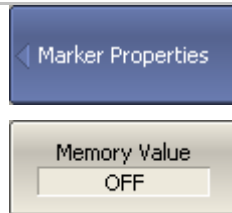

To enable/disable the display of memory trace marker values, toggle the softkey:

Marker > Marker Properties > Memory Value

6.1.7 Marker Position Search Functions

Marker position search function enables you to find on a trace the following values:

- maximum value;
- minimum value;
- peak value;
- target level.

6.1.7.1 Search for Maximum and Minimum

Maximum and minimum search functions enable you to determine the maximum and minimum values of the measured parameter and move the marker to these positions on the trace (See figure 6.5).

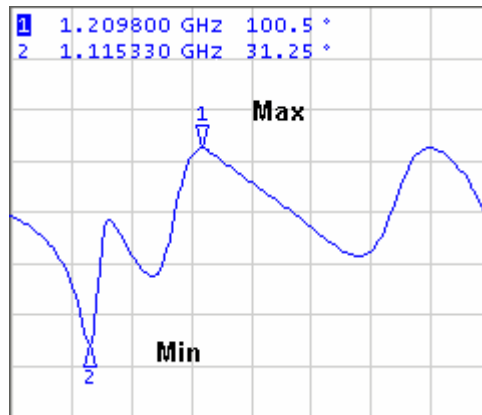
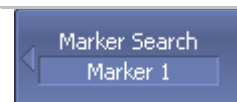

Figure 6.5 Maximum and minimum search



To find the maximum or minimum values on a trace, use the following softkeys:

Markers > Marker Search > Maximum

Markers > Marker Search > Minimum

Note

Before you start maximum or minimum search, first activate the marker.

In Smith chart and polar formats the search is executed for the first value of the marker.

6.1.7.2 Search for Peak

Peak search function enables you to determine the peak value of the measured parameter and move the marker to this position on the trace (See figure 6.6).

Peak is a local extremum of the trace.

Peak is called **positive** if the value in the peak is greater than the values of the adjacent points.

Peak is called **negative** if the value in the peak is smaller than the values of the adjacent points.

Peak excursion is the smallest of the absolute differences between the response values in the peak point and the two adjoining peaks of the opposite polarity.

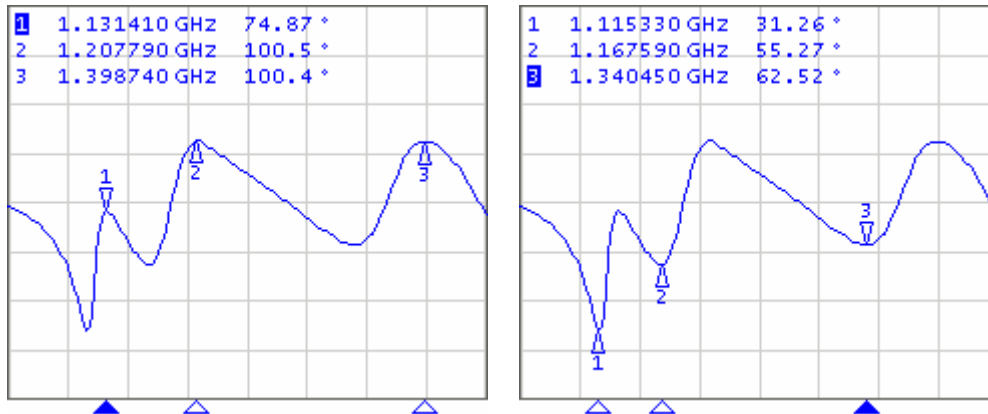

Figure 6.6 Positive and negative peaks

The peak search is executed only for the peaks meeting the following conditions:

- The peaks must have the polarity (positive, negative, or both) specified by the user;
- The peaks must have the peak deviation not less than the value assigned by the user.

The following options of the peak search are available:

- Search for nearest peak;
- Search for greatest peak;
- Search for left peak;
- Search for right peak.

The nearest peak is a peak, which is located most near to the current position of the marker along the stimulus axis.

The greatest peak is a peak with maximum or minimum value, depending on the current polarity settings of the peak.

Note

The search for the greatest peak is different from the search for maximum or minimum as the peak cannot be located in the limiting points of the trace even if these points have maximum or minimum values.

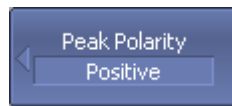

To set the polarity of the peak, use the following softkeys:

Markers > Marker Search > Peak > Peak Polarity > Positive | Negative | Both



To enter the peak excursion value, use the following softkeys:

Markers > Marker Search > Peak > Peak Excursion

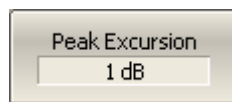

Then enter the value using numerical keypad, or «↑», «↓» arrows.

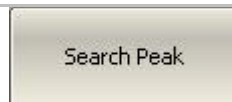

To activate the nearest peak search, use the following softkeys:

Markers > Marker Search > Peak > Search Peak

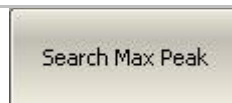

To activate the greatest peak search, use the following softkeys:

Markers > Marker Search > Peak > Search Max Peak

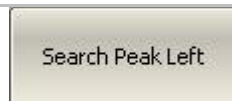

To activate the left peak search, use the following softkeys:

Markers > Marker Search > Peak > Search Peak Left

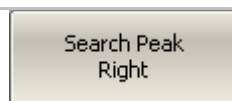

To activate the left peak search, use the following softkeys:

Markers > Marker Search > Peak > Search Peak Right

Note

Before you start maximum or minimum search, first activate the marker.

In Smith chart and polar formats the search is executed for the first value of the marker.

6.1.7.3 Search for Target Level

Target level search function enables you to locate the marker with the given level of the measured parameter (See figure 6.7).

The trace can have two types of transition in the points where the target level crosses the trace:

- transition type is positive if the function derivative (trace slope) is positive at the intersection point with the target level;
- transition type is negative if the function derivative (trace slope) is negative at the intersection point with the target level.

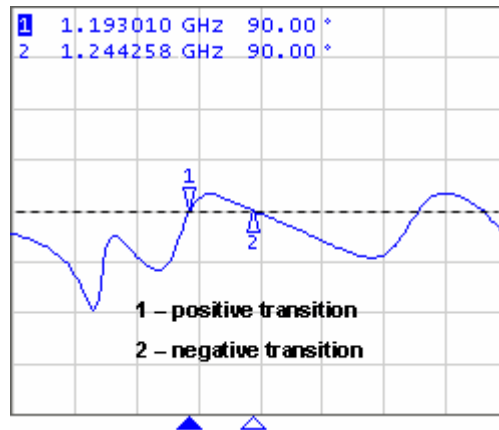
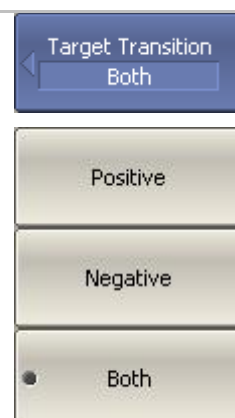

Figure 6.7 Target level search

The target level search is executed only for the intersection points, which have the specific transition polarity selected by the user (positive, negative, or both).

The following options of the target level search are available:

- Search for nearest target;
- Search for left target;
- Search for right target.



To set the transition polarity, use the following softkeys:

Markers > Marker Search > Target > Target Transition > Positive | Negative | Both



To enter the target level value, use the following softkeys:

Markers > Marker Search > Target > Target Value



Then enter the value using numerical keypad, or «↑», «↓» arrows.



To activate the nearest target search, use the following softkeys:

Markers > Marker Search > Target > Search Target



To activate the left target search, use the following softkeys:

Markers > Marker Search > Target > Search Target Left

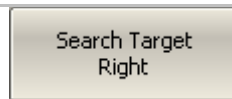

To activate the right target search, use the following softkeys:

Markers > Marker Search > Target > Search Target Right

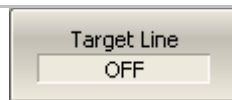

To enable/disable target level indication on the screen, use the following softkeys:

Markers > Marker Search > Target > Target Line



Clear All Target Lines softkey disables indication of target level lines of all the markers.

Note

Before you start maximum or minimum search, first activate the marker.

In Smith chart and polar formats the search is executed for the first value of the marker.

6.1.7.4 Search Tracking

The marker position search function by default can be initiated by any search key pressing. Search tracking mode allows you to perform continuous marker position search, until this mode is disabled.



To enable/disable search tracking mode, use the following softkeys:



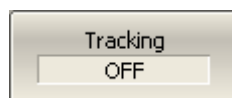





Markers > Marker Search > Tracking

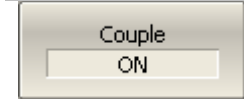

6.1.7.5 Search Range

The user can set the search range for the marker position search by setting the stimulus limits. This function involves the following additional features:

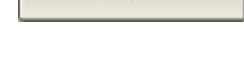
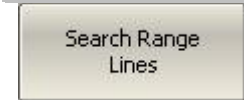
- search range coupling, which allows the user to define the same search range for all the traces of a channel;
- vertical line indication of the search range limits.

	<p>To enable/disable the search range, use the following softkeys:</p>
	<p>Markers > Marker Search > Search Range</p>
	<p>To set the search range limits, use the following softkeys:</p>
	<p>Markers > Marker Search > Search Start</p>
	<p>Markers > Marker Search > Search Stop</p>
	<p>To enable/disable search range coupling, use the following softkeys:</p>
	<p>Markers > Marker Search > Couple</p>
	<p>To enable/disable search range limits indication, use the following softkeys:</p>
	<p>Markers > Marker Search > Search Range Lines</p>

6.1.8 Marker Math Functions

Marker math functions are the functions, which use markers for calculating of various trace characteristics. Four marker math functions are available:

- Statistics;
- Bandwidth Search;
- Flatness;
- RF Filter.

6.1.8.1 Trace Statistics

The *trace statistics* feature allows the user to determine and view such trace parameters as mean, standard deviation, and peak-to-peak. The trace statistics range can be defined by two markers (See figure 6.8).

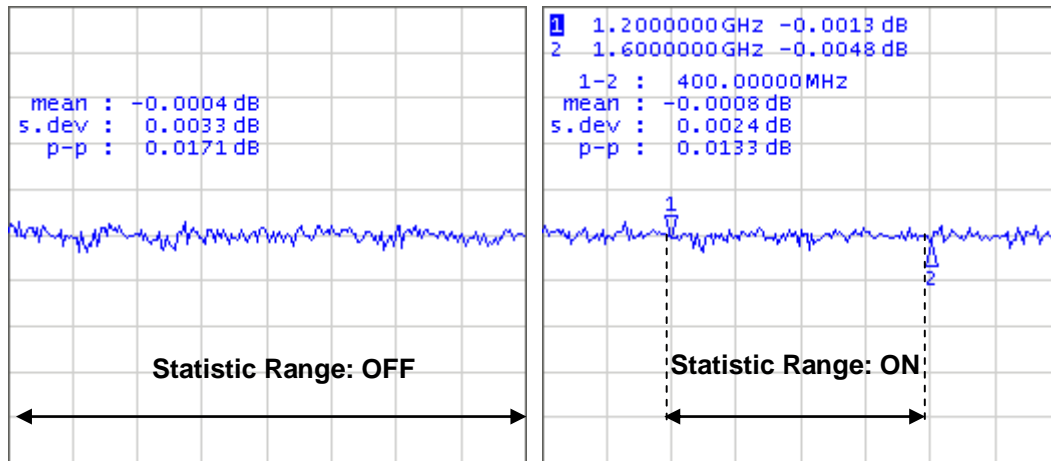
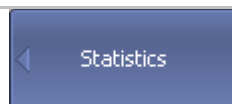

Figure 6.8 Trace statistics

Table 6.2 Statistics parameters

Symbol	Definition	Formula
mean	Arithmetic mean	$M = \frac{1}{N} \cdot \sum_{i=1}^N x_i$
s.dev	Standard deviation	$\sqrt{\frac{1}{N-1} \cdot \sum_{i=1}^N (x_i - M)^2}$
p-p	Peak-to-Peak: difference between the maximum and minimum values	Max – Min



To enable/disable trace statistics function, use the following softkeys:

Markers > Marker Math > Statistics > Statistics

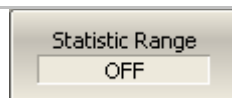
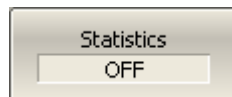

To enable/disable trace statistics range, use the following softkeys:

Markers > Marker Math > Statistics > Statistic Range

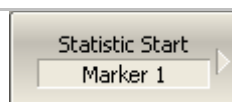

To set the start/stop markers of the statistics range, use the following softkeys:

Markers > Marker Math > Statistics > Statistic Start

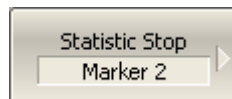

Markers > Marker Math > Statistics > Statistic Stop

6.1.8.2 Bandwidth Search

The *bandwidth search* function allows the user to determine and view the following parameters of a passband or a stopband: bandwidth, center frequency, lower frequency, higher frequency, Q value, and insertion loss (See figure 6.9). In the figure, F1 and F2 are the lower and higher cutoff frequencies of the band respectively.

The bandwidth search is executed from the reference point. The user can select as reference point the active marker or the maximum of the trace. The bandwidth search function determines the lower and higher cutoff frequencies, which are apart from the reference point response by *bandwidth value* defined by the user (usually -3 dB).

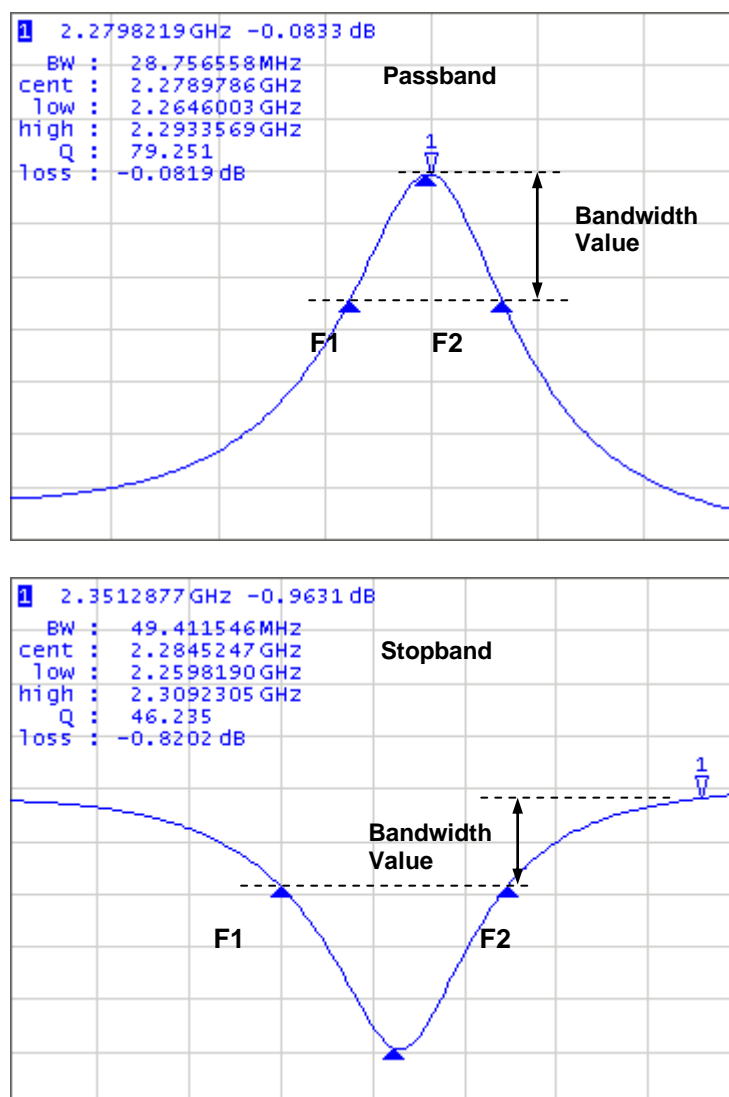

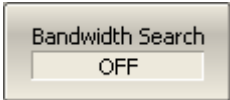
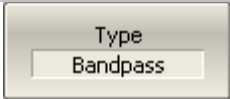

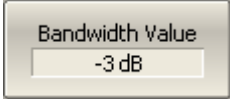

Figure 6.9 Bandwidth search

Table 6.3 Bandwidth parameters

Parameter Description	Symbol	Definition	Formula
Bandwidth	BW	The difference between the higher and lower cutoff frequencies	$F2 - F1$
Center Frequency	cent	The midpoint between the higher and lower cutoff frequencies	$(F1+F2)/2$
Lower Cutoff Frequency	low	The lower frequency point of the intersection of the bandwidth cutoff level and the trace	F1
Higher Cutoff Frequency	high	The higher frequency point of the intersection of the bandwidth cutoff level and the trace	F2
Quality Factor	Q	The ratio of the center frequency to the bandwidth	Cent/BW
Loss	loss	The trace measured value in the reference point of the bandwidth search	-

	<p>To enable/disable bandwidth search function, use the following softkeys:</p> <p>Markers > Marker Math > Bandwidth Search > Bandwidth Search</p>
	
	<p>Set the bandwidth search type by softkeys:</p> <p>Markers > Marker Math > Bandwidth Search > Type</p> <p>The type and the softkey label toggle between Bandpass and Notch settings.</p>
	<p>To set the search reference point, use the following softkeys:</p> <p>Markers > Marker Math > Bandwidth Search > Search Ref To</p> <p>The type and the softkey label toggle between Max and Marker settings.</p>
	<p>To enter the bandwidth value, use the following softkeys:</p> <p>Markers > Marker Math > Bandwidth Search > Bandwidth Value</p>

6.1.8.3 Flatness

The *flatness search* function allows the user to determine and view the following trace parameters: gain, slope, and flatness. The user sets two markers to specify the flatness search range (See figure 6.10).

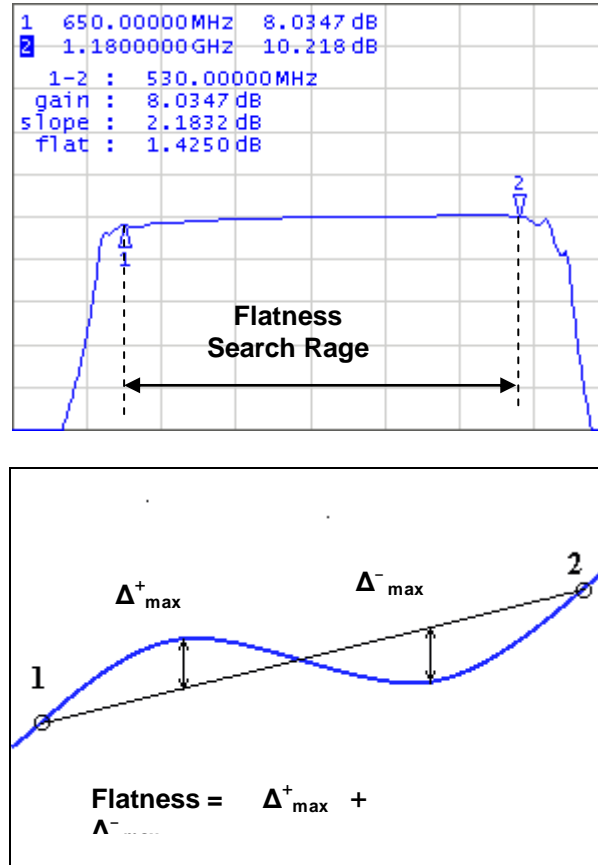
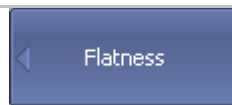

Figure 6.10 Flatness search

Table 6.4 Flatness parameters

Parameter Description	Symbol	Definition
Gain	gain	Marker 1 value
Slope	slope	Difference between marker 2 and marker 1 values.
Flatness	flatness	Sum of “positive” and “negative” peaks of the trace, which are measured from the line connecting marker 1 and marker 2 (See figure 6.10).



To enable/disable the flatness search function, use the following softkeys:

Markers > Marker Math > Flatness > Flatness

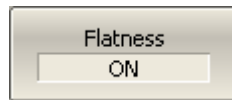

To select the markers specifying the flatness search range, use softkeys:

Markers > Marker Math > Flatness > Flatness Start



Markers > Marker Math > Flatness > Flatness Stop

6.1.8.4 RF Filter Statistics

The *RF filter statistics* function allows the user to determine and view the following filter parameters: loss, peak-to-peak in a passband, and rejection in a stopband. The passband is specified by the first pair of markers, the stopband is specified by the second pair of markers (See figure 6.11).

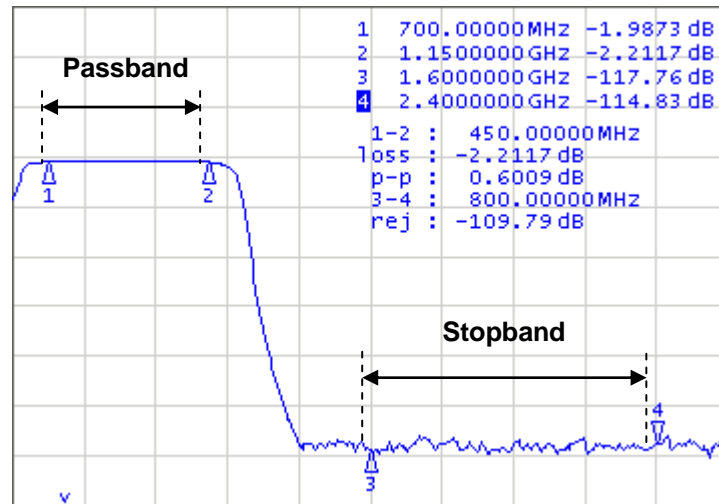
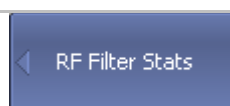

Figure 6.11 RF filter statistics

Table 6.5 RF filter statistics parameters

Parameter Description	Symbol	Definition
Loss in passband	loss	Minimum value in the passband
Peak-to-peak in passband	p-p	Difference between maximum and minimum in the passband
Reject	rej	Difference between maximum in stopband and minimum in passband



To enable/disable the RF filter statistics function, use the following softkeys:

Markers > Marker Math > RF Filter Stats > RF Filter Stats

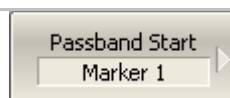
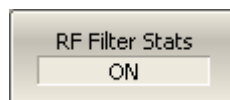

To select the markers specifying the passband, use the following softkeys:

Markers > Marker Math > RF Filter Stats > Passband Start

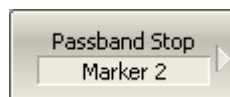

Markers > Marker Math > RF Filter Stats > Passband Stop

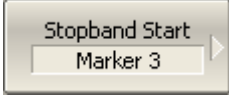
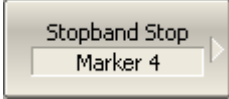
	<p>To select the markers specifying the stopband, use the following softkeys:</p>
	<p>Markers > Marker Math > RF Filter Stats > Stopband Start Markers > Marker Math > RF Filter Stats > Stopband Stop</p>

6.1.9 Marker Functions

Using the current position of a marker you can perform settings of the following parameters:

- Stimulus start;
- Stimulus stop;
- Stimulus center;
- Reference level;
- Electrical delay.

Before performing the settings, first activate the marker.

	<p>To set the stimulus start, use the following softkeys:</p>
	<p>Markers > Marker Functions > Marker->Start</p>
	<p>To set the stimulus stop, use the following softkeys:</p>
	<p>Markers > Marker Functions > Marker->Stop</p>
	<p>To set the stimulus center, use the following softkeys:</p>
	<p>Markers > Marker Functions > Marker->Center</p>
	<p>To set the reference level, use the following softkeys:</p>
	<p>Markers > Marker Functions > Marker->Ref Value</p>
	<p>To set the electrical delay, use the following softkeys:</p>
	<p>Markers > Marker Functions > Marker->Delay</p>
	<p>To set reference marker to the active marker point, use the following softkeys:</p>
	<p>Markers > Marker Functions > Marker->Ref Marker</p>

6.2 Memory Trace Function

For each data trace displayed on the screen a so-called memory trace can be created. The memory trace is displayed in the same color as the main data trace, but its brightness is twice lower¹.

The data trace shows the currently measured data and is continuously being updated as the measurement goes on.

The memory trace is a data trace saved into the memory. It is created from the current measurement when the user is clicking the corresponding softkey. After that, the two traces become displayed on the screen – the data trace and the memory trace. The user can customize the trace indication. The trace status field will indicate the following:

- **D&M** – data trace and memory trace are displayed;
- **M** – only memory trace is displayed;
- **OFF** – both traces are not displayed
- *Empty field* – only data trace is displayed.

The memory trace bears the following features of the data trace (which if changed, will **clear** the memory):

- frequency range,
- number of points,
- sweep type.

The memory trace has the following settings common with the data trace (which if changed, modifies the both traces):

- format,
- scale,
- smoothing,
- electrical delay.

The following data trace settings (if changed after the memory trace creation) do not influence the memory trace:

- power in frequency sweep mode,
- frequency in power sweep mode,
- measured parameter (S-parameter),
- IF bandwidth,
- averaging,
- calibration.

The memory trace can be used for math operations with the data trace. The resulting trace of such an operation will replace the data trace. The math operations with memory

¹ The color and brightness of the data and memory traces can be customized by the user (See section 8.6).

and data traces are performed in complex values. The following four math operations are available:

Data / Memory	Divides the measured data by the data in the memory trace. The trace status field indicates: D/M .
Data * Memory	Multiplies the measured data by the memory trace. The trace status field indicates: D*M .
Data – Memory	Subtracts a memory trace from the measured data. The trace status field indicates: D–M .
Data + Memory	Adds the measured data to the data in the memory trace. The trace status field indicates: D+M .

6.2.1 Saving Trace into Memory

The memory trace function can be applied to the individual traces of the channel. Before you enable this function, first activate the trace.

	<p>To save a trace into the memory, use the following softkeys:</p> <p>Display > Data->Memory</p>
---	--

6.2.2 Trace Display Setting

	<p>To set the type of data to be displayed on the screen, use the following softkeys:</p> <p>Display > Display > Data Memory Data & Memory OFF</p>
---	---

6.2.3 Mathematical Operations

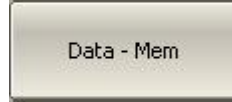

To access math operations, use the following softkeys:

Display > Data Math

Data/Mem | Data * Mem | Data – Mem | Data + Mem | OFF

6.3 Fixture Simulation

Fixture simulation is a set of software functions for simulating measurement conditions which are different from the actual measurement conditions. Fixture simulation includes the following functions.

For unbalanced circuits

- Port reference impedance conversion
- Circuit de-embedding

Circuit embedding

- 4-port network embedding/de-embedding.
- For balanced circuits
- Balance-unbalance conversion.

The logic circuit of fixture simulation function is shown in Figure 6.12. The data processing flow diagram of fixture simulation function is shown in Figure 6.13.

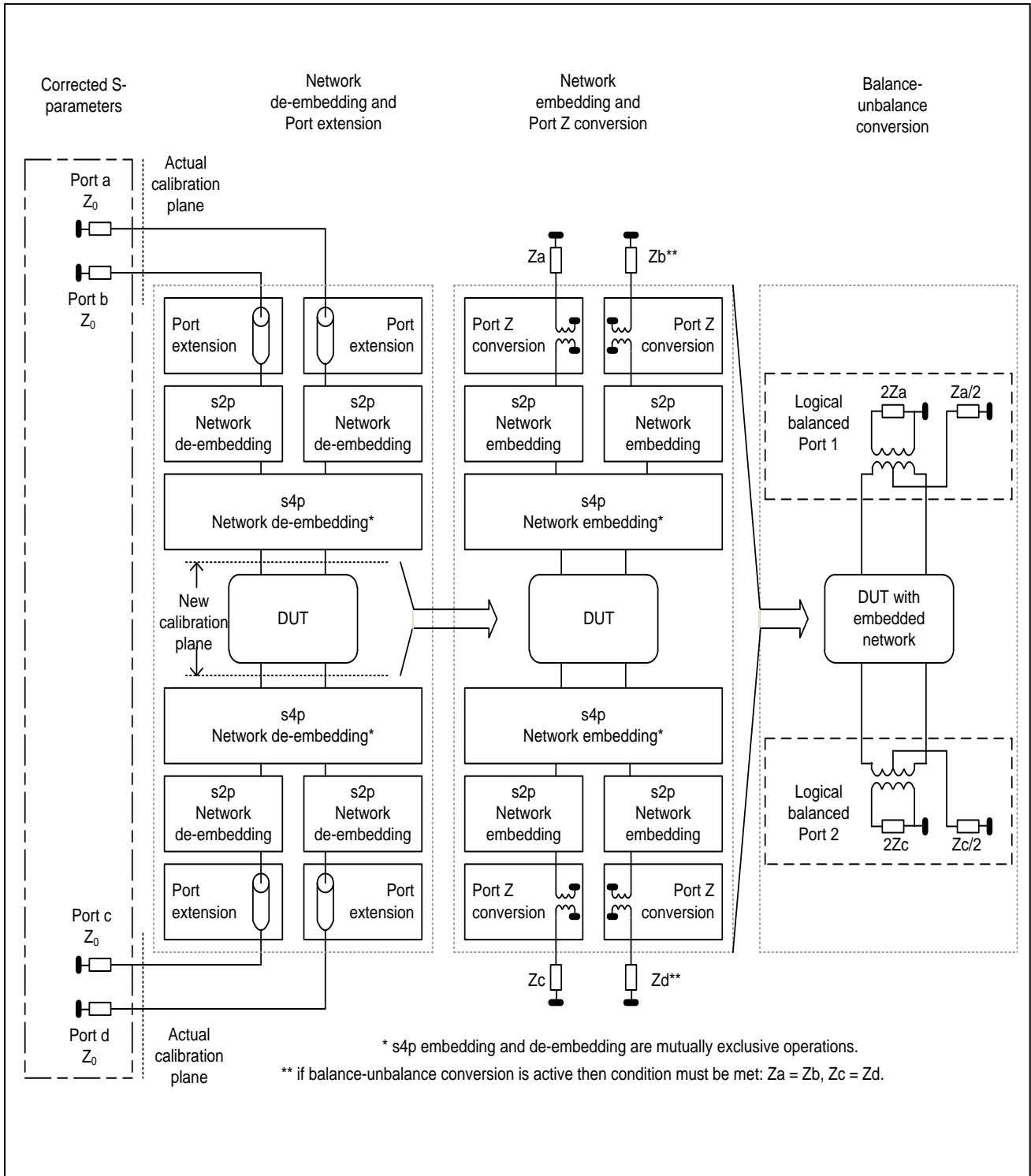

Figure 6.12 Logic diagram of fixture simulation function

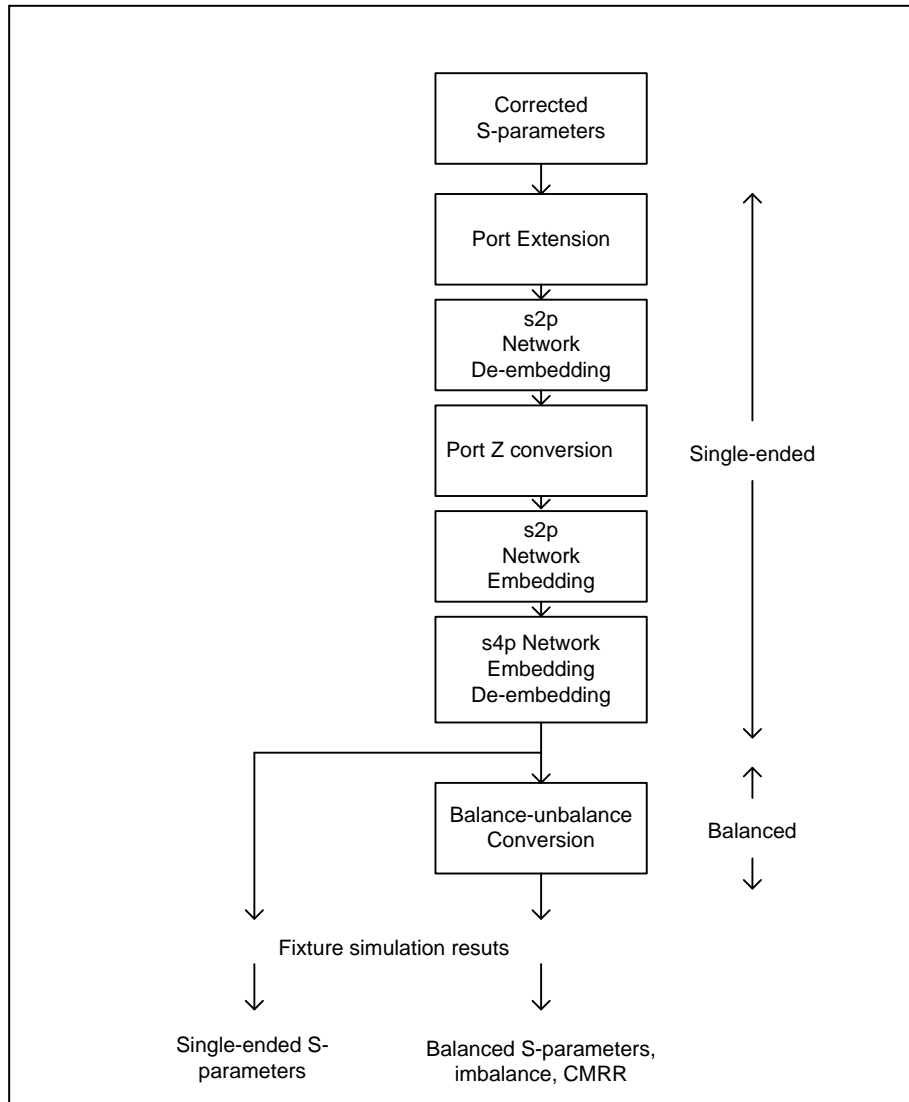

Figure 6.13 Data processing flow diagram of fixture simulation function

Before starting the fixture simulation, first activate the channel. The simulation function will affect all the traces of the channel.



To open the fixture simulation menu, use the following softkeys:

Analysis > Fixture Simulator

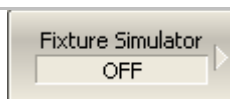

To enable/disable fixture simulator use the softkey:

Fixture Simulator [ON | OFF]

Note

The **Fixture Simulator** softkey enables or disables fixture simulation in general. Each fixture simulator function has its own on/off softkey.

6.3.1 Port Reference Impedance Conversion

Port reference impedance conversion is a function that uses software to convert an S-parameter measured with a Z_0 port reference impedance into a value measured with an arbitrary impedance (See figure 6.14).

Note

The value of the Z_0 port reference impedance (commonly 50 Ohm) is defined in the process of the calibration. It is determined by the characteristic impedance of the calibration kit and its value is entered by the user as described in section 5.2.12.

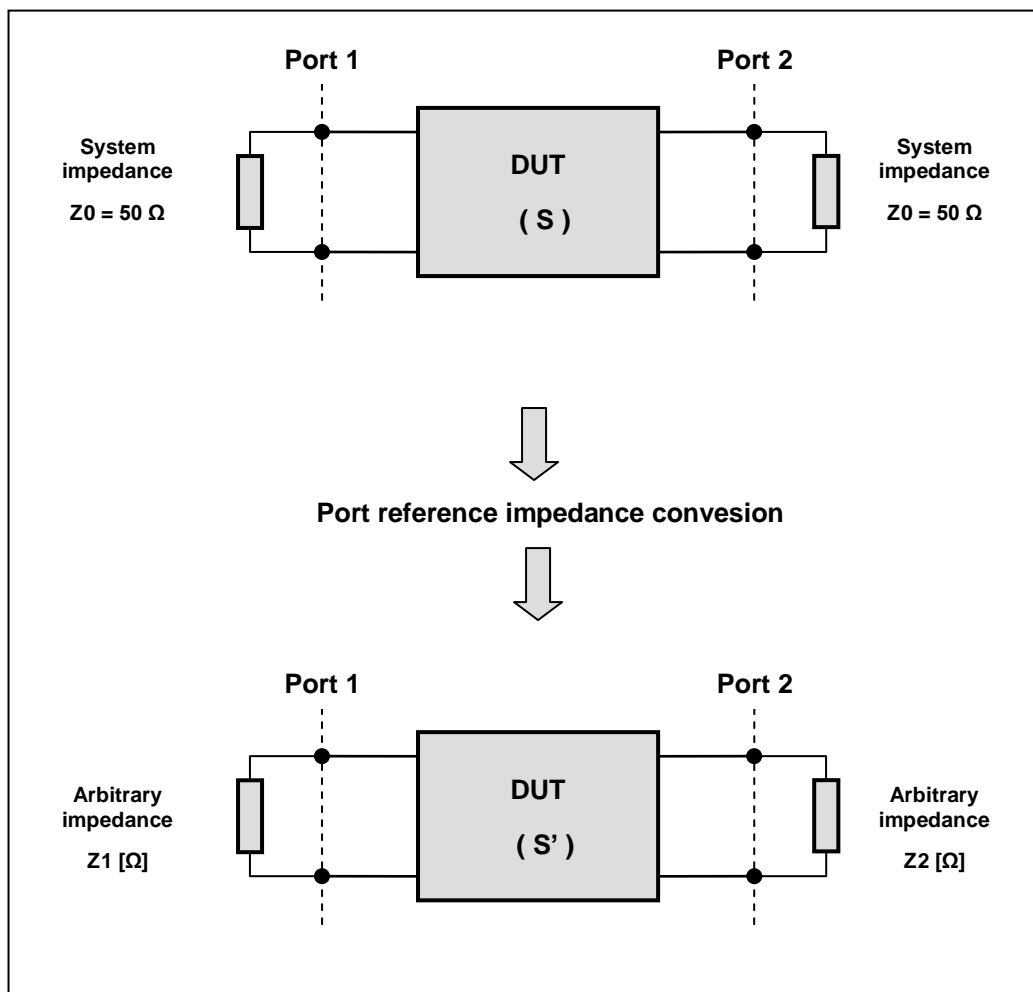
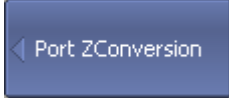
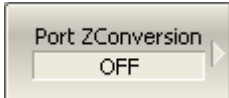
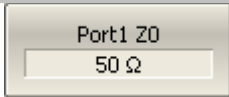
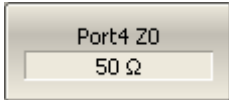

Figure 6.14 Port reference impedance conversion

	<p>To enable/disable the port reference impedance conversion function, use the following softkeys:</p>
	<p>Port Z Conversion > Port Z Conversion [ON OFF]</p>
	<p>To enter the value of the simulated impedance of Port n, use Port n Z0 softkey.</p>
<p>...</p>	
	

6.3.2 De-embedding

De-embedding is a function of the S-parameter conversion by removing the effect of a certain circuit from the measurement results.

The circuit being removed should be defined in the data file containing S-parameters of this circuit. The circuit should be described as a 2-port in Touchstone file (with the .s2p extension), which contains the S-parameter table: S_{11} , S_{21} , S_{12} , S_{22} for a number of frequencies.

The de-embedding function allows to mathematically exclude from the measurement results the effect of the fixture circuit existing between the calibration plane and the DUT in the real network. The fixture is used for the DUTs, which cannot be directly connected to the test ports.

The de-embedding function shifts the calibration plane closer to the DUT, so as if the calibration has been executed for the network with this circuit removed (See figure 6.13).

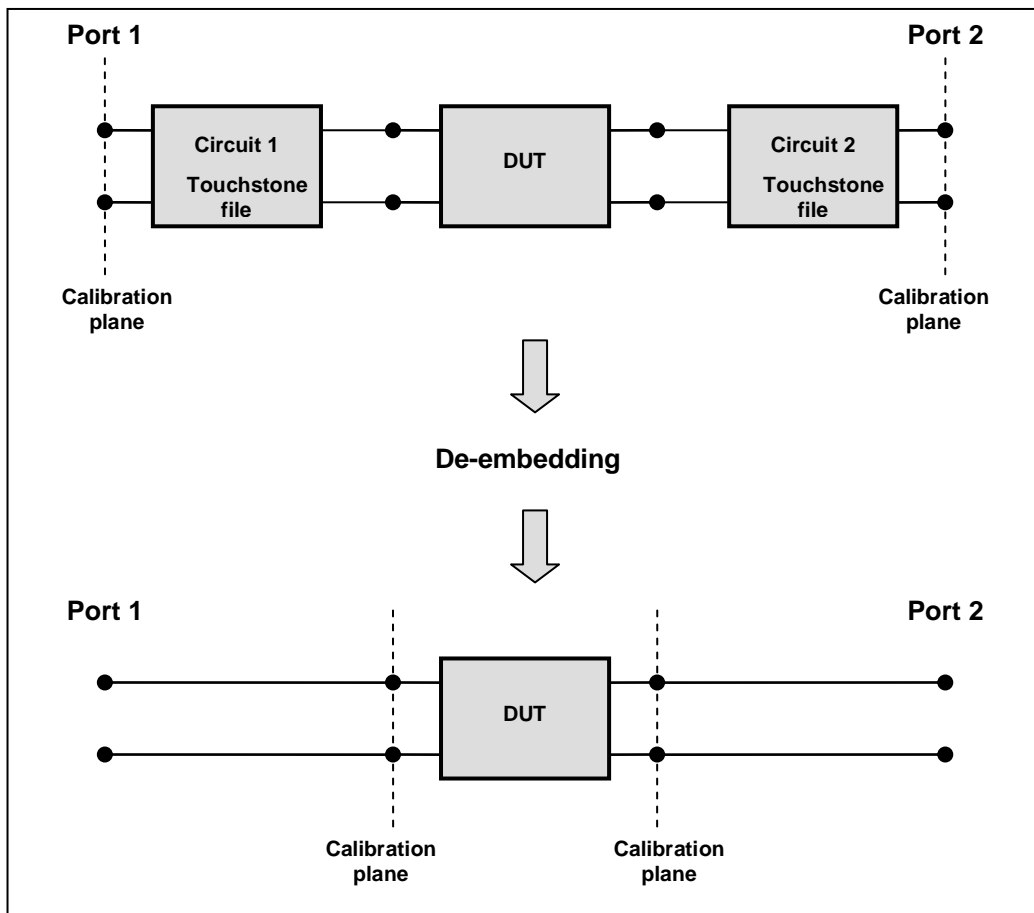
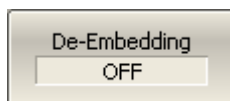

Figure 6.15 De-embedding



To enable/disable the de-embedding function, use the following softkeys:



De-Embedding > De-Embedding [ON | OFF].

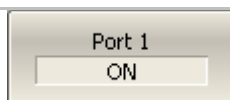

To enable/disable the de-embedding function for port n, use the following softkey:

Port n [ON | OFF]

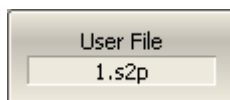

To enter the file name of the de-embedded circuit S-parameters of port n, use the following softkey:

User File

Note

If user file is not specified, the softkey of the function activation will be grayed out.

6.3.3 Embedding

Embedding is a function of the S-parameter conversion by integration of some virtual circuit into the real network (See figure 6.14). The embedding function is an inverted de-embedding function.

The circuit being integrated should be defined in the data file containing S-parameters of this circuit. The circuit should be described as a 2-port in Touchstone file (with the.s2p extension), which contains the S-parameter table: S_{11} , S_{21} , S_{12} , S_{22} for a number of frequencies.

The embedding function allows to mathematically simulate the DUT parameters after adding of the fixture circuits.

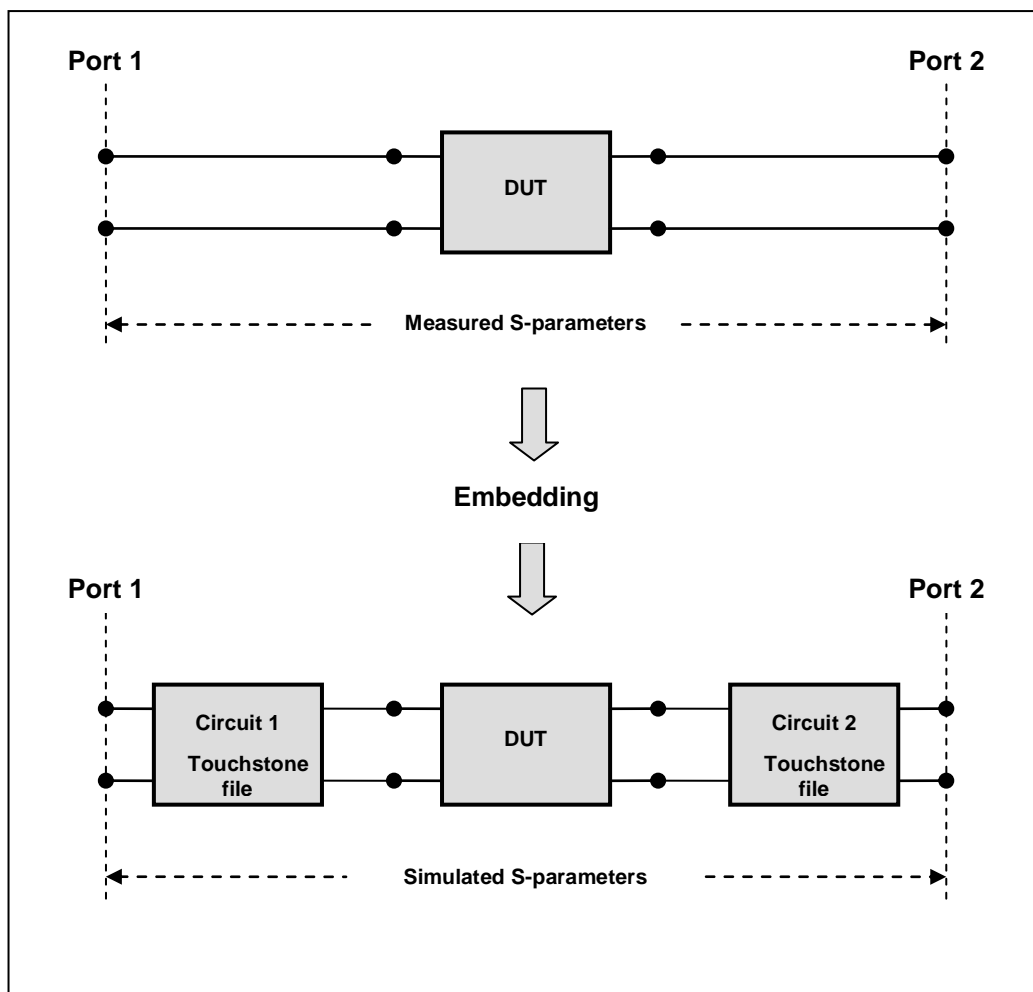

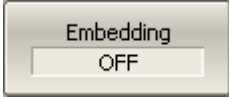
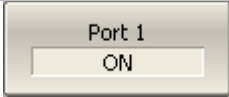

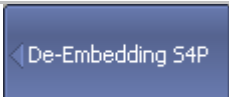
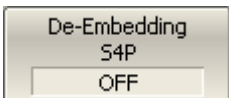

Figure 6.16 Embedding

	<p>To enable/disable the embedding function, use the following softkeys:</p>
	<p>Embedding > Embedding [ON OFF]</p>
	<p>To enable/disable the embedding function for port n, use the following softkey:</p>
	<p>Port n [ON OFF]</p>
	<p>To enter the file name of the embedded circuit S-parameters of port n, use the following softkey:</p>
	<p>User File</p>
<p>Note</p>	<p>If user file is not specified, the softkey of the function activation will be grayed out.</p>

6.3.4 4-Port Network Embedding/De-embedding

4-port network embedding/de-embedding is a function of S-parameters conversion, using a 4-port network as an embedded or de-embedded network. The network is a Touchstone file (with the .s4p extension), containing an S-parameter table of S_{11} , S_{21} , S_{31} , S_{41} , ... S_{44} for a number of frequencies. The embedding and de-embedding operations of this function are mutually exclusive.

	<p>To enable/disable the embedding function, use the following softkeys:</p>
	<p>De-Embedding S4P > De-Embedding S4P [ON OFF]</p>

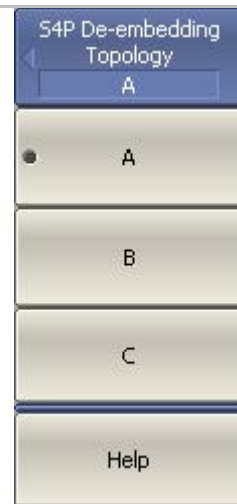

Select the embedded or de-embedded 4-port network topology using the following softkeys:

Topology > [A | B | C]

To display the selected topology, use the following softkey:

Help

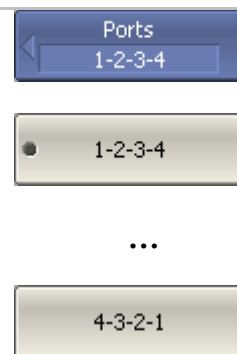
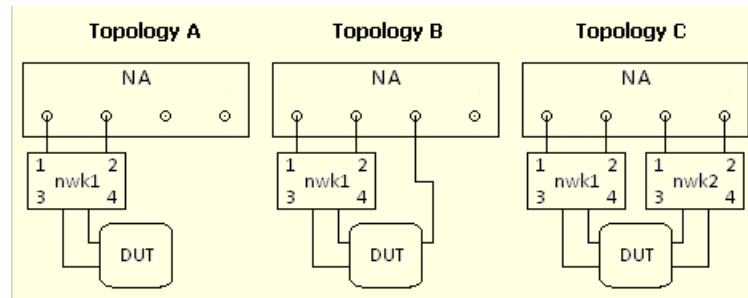

To select the numbers of ports, connected to the embedded or de-embedded network, use the following softkeys:

Ports > [1-2-3-4 | ... 4-3-2-1]

Note: The set of available port numbers depends on the topology selected.

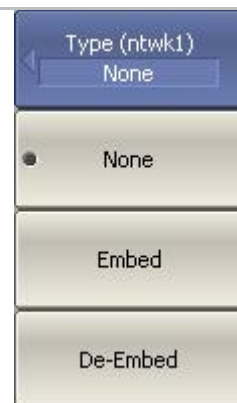

To select an operation with the **ntwk1** and/or **ntwk2** network (see topology), use the following softkeys:

Type (ntwk1) > [None | Embed | De-Embed]

Type (ntwk2) > [None | Embed | De-Embed]

Note: First you need to specify the name of the s4p file for the **ntwk1** and/or **ntwk2** network. Otherwise the operation softkey will be disabled.

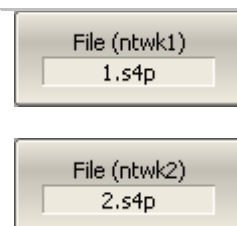

To enter the S-parameter file name of the s4p embebbed or de-embedd circuit for the **ntwk1** and/or **ntwk2** network, use the following softkeys:

File (ntwk1)

File (ntwk2)

Help

To display the final circuit based on topology, port numbers, operations and files, use the softkey:

Help

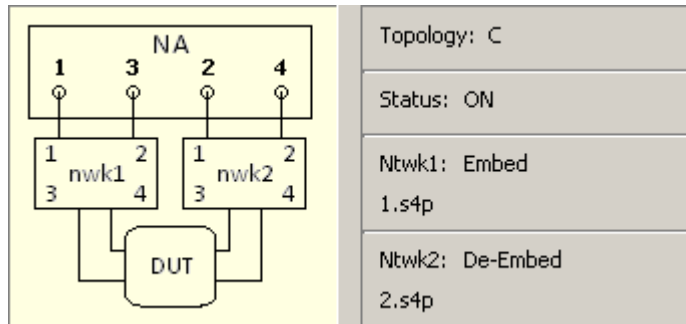

6.3.5 Measurement of Balanced Devices

6.3.5.1 Balance-Unbalance Conversion

Balance-unbalance conversion simulates measurements in the balanced circuits using the results of unbalanced measurements. This allows evaluating balanced parameters of balanced devices. The diagram of balance-unbalance conversion is shown in Figure 6.17. The types of evaluated balanced devices are shown in Figure 6.18.

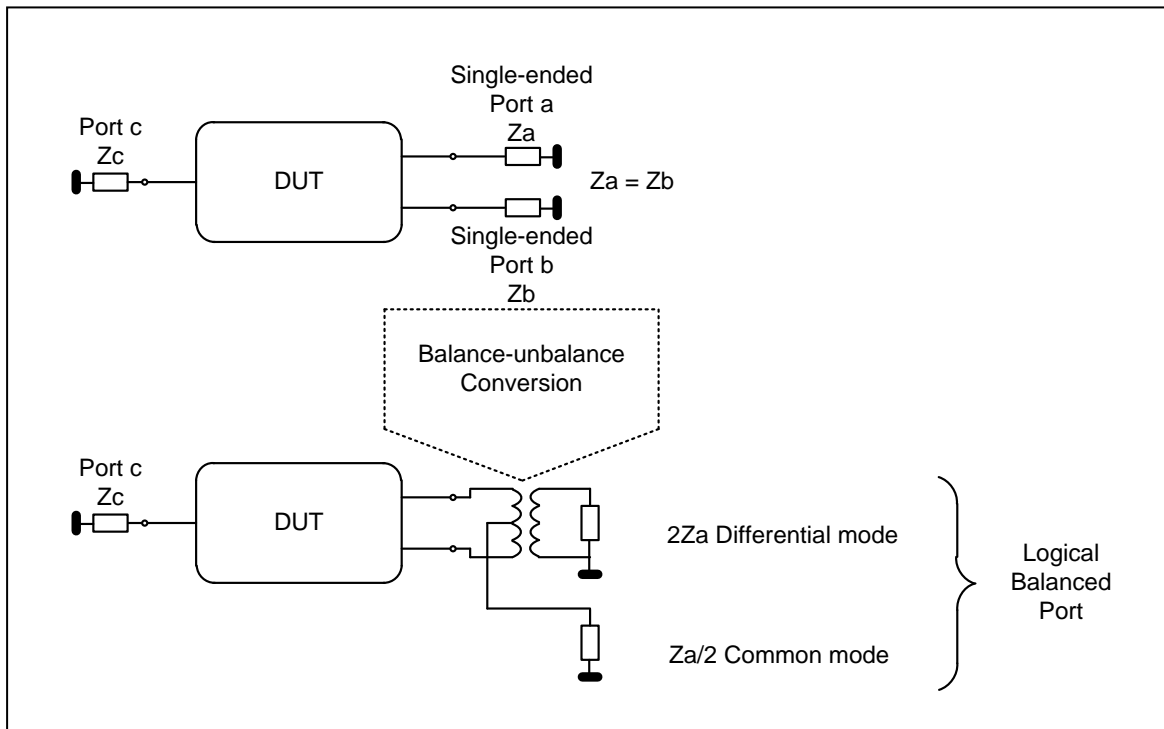

Figure 6.17 Balance-unbalance conversion diagram

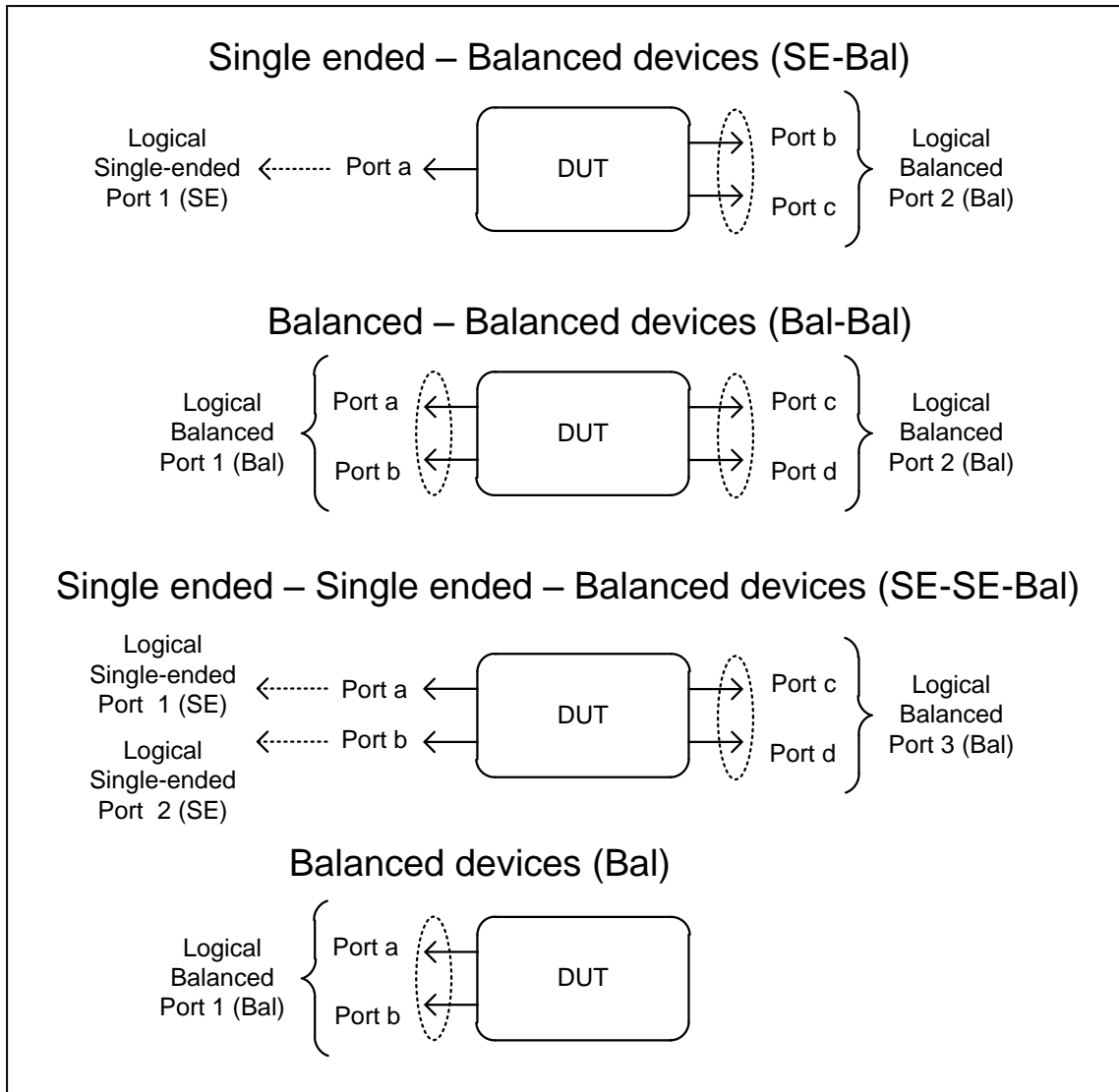
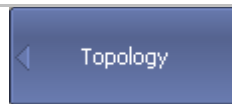
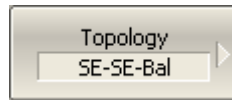

Figure 6.18 Types of balanced devices

Unlike other fixture simulation functions, the balance-unbalance conversion function has an active trace and not the whole channel as a target. Before using this function you have to select the target trace.



Define the balanced devices topology using the following softkeys:



Topology > Device > [SE-Bal | Bal-Bal | SE-SE-Bal | Bal]

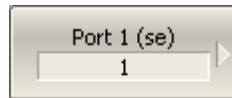

Match the port numbers to the logical (balanced) ports using the following softkeys:

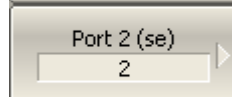

Port 1 (se | bal)

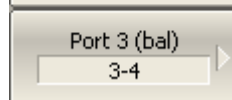

Port 2 (se | bal)

Port 3 (bal)

Then select the analyzer port numbers connected to the selected logical ports.

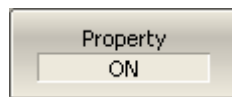

To display the matching numbers with ports use the softkey:

Property

```
BALUN
1 SE
2 SE
3 }
4 } BAL
```

To display the balance-unbalance conversion diagram use the softkey:

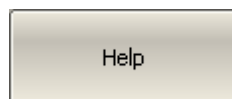

Help

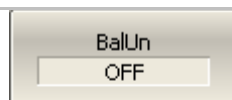
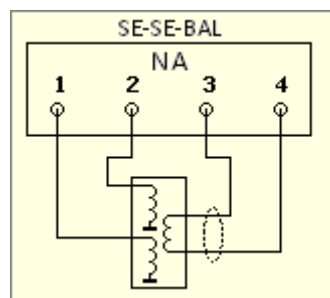

To enable the balance-unbalance conversion function use the following softkeys:

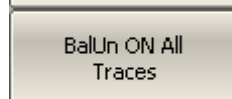

BalUn [ON | OFF] – for active trace

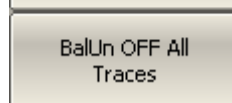

BalUn ON All Traces – enable for all traces

BalUn OFF All Traces – disable for all traces

	<p>To select the measured balanced parameter for each trace use the following softkeys:</p> <p>Measurement > [Sdd11 ... CMRR]</p> <p>Note: The set of available balanced parameters depends on the topology selected. See the next section for the detailed description of balanced parameters.</p>
---	---

6.3.5.2 Balanced Parameters

The balance-unbalance conversion function calculates and displays the following parameters:

- Mixed mode S-parameters
- Imbalance parameters
- Common Mode Rejection Ratio.

Notation of mixed mode S-parameters:

S_{xyAB} , where

B – Stimulus logical port number

A – Response logical port number

y – Stimulus logical port measurement mode

x – Response logical port measurement mode.

x and y represent logical ports measurement modes (see Figure 6.17 Balance-unbalance conversion diagram, Figure 6.18 Types of balanced devices):

s – Single-ended (unbalanced) measurement mode

d – Differential measurement mode

c – Common measurement mode

Thus,

$$S_{xyAB} = \frac{x \text{ mode input signal at port } A}{y \text{ mode output signal at port } B}$$

Below are the four definitions of the mixed mode S-parameters for four topologies of balanced devices (see Figure 6.18).

The mixed mode S-parameters for single-ended-balanced devices (SE-Bal).

<i>Logical port mode</i>	Stimulus	Single-ended	Differential	Common
Receiver	<i>Logical port number</i>	1	2	2
Single-ended	1	Sss11	Ssd12	Ssc12
Differential	2	Sds21	Sdd22	Sdc22
Common	2	Scs21	Scd22	Sc22

The mixed mode S-parameters for balanced-balanced devices (Bal-Bal).

<i>Logical port mode</i>	Stimulus	Differential		Common	
Receiver	<i>Logical port number</i>	1	2	1	2
Differential	1	Sdd11	Sdd12	Sdc11	Sdc12
	2	Sdd21	Sdd22	Sdc21	Sdc22
Common	1	Scd11	Scd12	Sc21	Sc22
	2	Scd21	Scd22	Sc21	Sc22

The mixed mode S-parameters for single-ended – single-ended - balanced devices (SE-SE-Bal).

<i>Logical port mode</i>	Stimulus	Single-ended		Differential	Common
Response	<i>Logical port number</i>	1	2	3	3
Single-ended	1	Sss11	Sss12	Ssd13	Ssc13
Single-ended	2	Sss21	Sss22	Ssd23	Ssc23
Differential	3	Sds31	Sds32	Sdd33	Sdc33
Common	3	Scs31	Scs32	Scd33	Sc33

The mixed mode S-parameters for balanced devices (Bal).

<i>Logical port mode</i>	Stimulus	Differential	Common
Response	<i>Logical port number</i>	1	1
Differential	1	Sdd11	Sdc11
Common	1	Scd1	Sc11

The balanced devices measurement results can be also represented as imbalance parameters. Figure 6.19 shows the functions of imbalance parameter calculation for the following three types of balanced devices. Note that imbalance parameters are calculated only using data of single-ended devices.

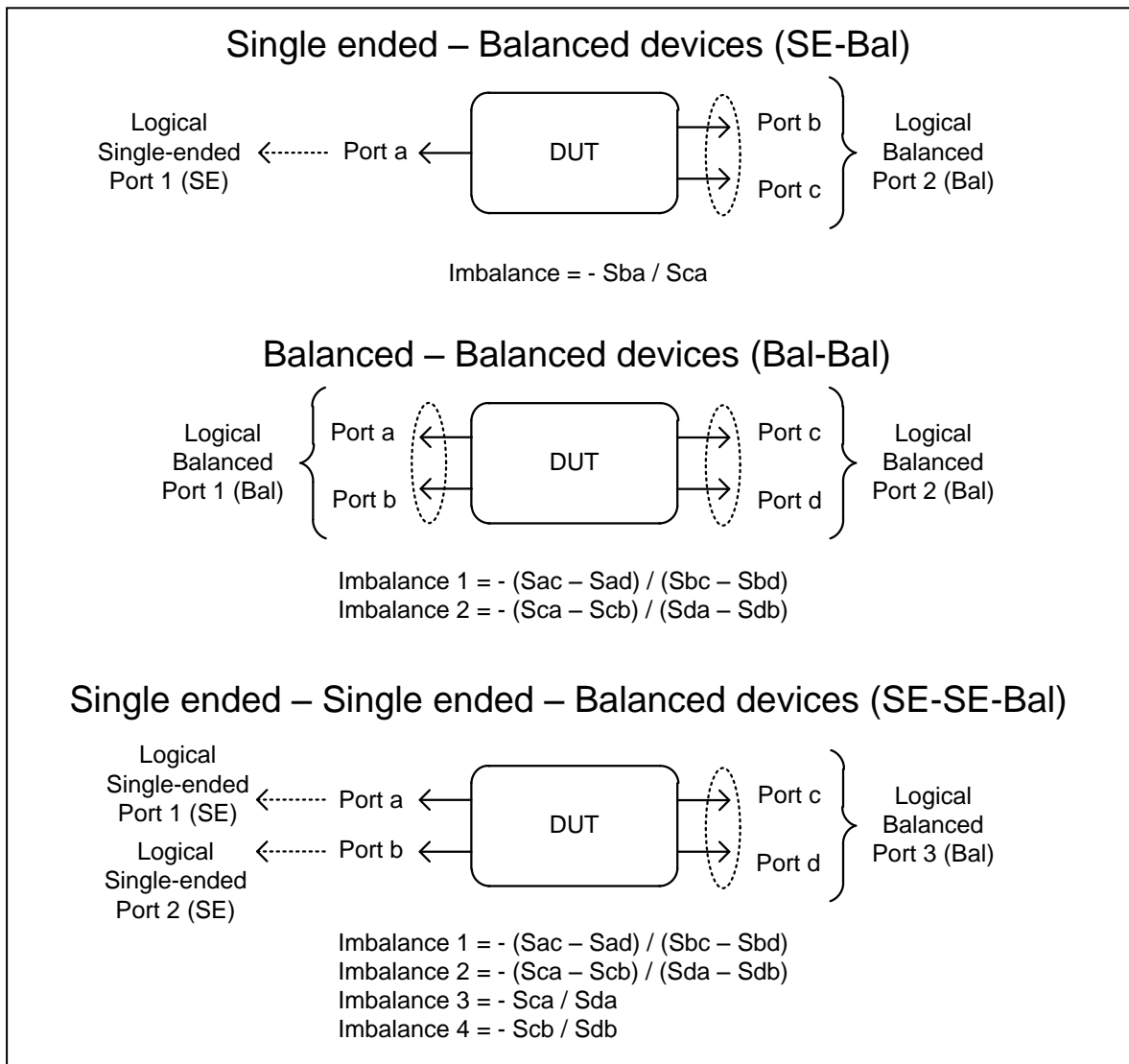

Figure 6.19 Imbalance parameters

A convenient way of evaluating balanced devices parameters is their representation using common mode rejection ratio (CMRR). This ratio is calculated after balance-unbalance conversion of mixed mode S-parameters.

For single-ended - balanced devices:

$$\text{CMRR1} = S_{ds21} / S_{cs21}$$

$$\text{CMRR2} = S_{sd12} / S_{sc12}$$

For balanced - balanced devices:

$$\text{CMRR} = S_{dd21} / S_{cc21}$$

For single-ended – single-ended – balanced devices:

$$\text{CMRR1} = S_{ds31} / S_{cs31}$$

$$\text{CMRR2} = \text{Sds32} / \text{Scs32}.$$

6.4 Time Domain Transformation

The Analyzer measures and displays parameters of the DUT in frequency domain. Time domain transformation is a function of mathematical conversion of the measured parameters in order to obtain the time domain representation.

For time domain transformation Z-transformation and frequency domain window function are applied.

The time domain transformation can be activated for separate traces of a channel. The current trace parameter (S_{11} , S_{21} , ... S_{44}) in frequency domain will be transformed into the time domain.

Note	Traces in frequency and time domains can simultaneously belong to one channel. The stimulus axis label will be displayed for the active trace, in frequency or time units.
------	--

The transformation function allows for setting of the measurement range in time domain within Z-transformation ambiguity range. The ambiguity range is determined by the measurement step in the frequency domain:

$$\Delta T = \frac{1}{\Delta F}; \quad \Delta F = \frac{F_{\max} - F_{\min}}{N - 1}$$

The time domain function allows to select the following transformation types:

- Bandpass mode simulates the impulse bandpass response. It allows the user to obtain the response for circuits incapable of direct current passing. The frequency range is arbitrary in this mode. The time domain resolution in this mode is twice lower than it is in the lowpass mode;
- Lowpass mode simulates lowpass impulse and lowpass step responses. It is applied to the circuits passing direct current, and the direct component (in point $F=0$ Hz) is interpolated from the start frequency (F_{\min}) of the range. In this mode the frequency range represents a harmonic grid where the frequency value at each frequency point is an integer multiple of the start frequency of the range F_{\min} . The time domain resolution is twice higher than it is in the bandpass mode.

The time domain transformation function applies Kaiser window for initial data processing in frequency domain. The window function allows to reduce the ringing (side lobes) in the time domain. The ringing is caused by the abrupt change of the data at the limits of the frequency domain. But while side lobes are reduced, the main pulse or front edge of the lowpass step becomes wider.

The Kaiser window is described by β parameter, which smoothly fine-tune the window shape from minimum (rectangular) to maximum. The user can fine-tune the window shape or select one of the three preprogrammed windows:

- **Minimum** (rectangular);
- **Normal**;
- **Maximum**.

Table 6.6 Preprogrammed window types

Window	Lowpass Impulse		Lowpass Step	
	Side Lobes Level	Pulse Width	Side Lobes Level	Edge Width
Minimum	- 13 dB	$\frac{0.6}{F_{\max} - F_{\min}}$	- 21 dB	$\frac{0.45}{F_{\max} - F_{\min}}$
Normal	- 44 dB	$\frac{0.98}{F_{\max} - F_{\min}}$	- 60 dB	$\frac{0.99}{F_{\max} - F_{\min}}$
Maximum	- 75 dB	$\frac{1.39}{F_{\max} - F_{\min}}$	- 70 dB	$\frac{1.48}{F_{\max} - F_{\min}}$

6.4.1 Time Domain Transformation Activating



To enable/disable time domain transformation function, use the following softkeys:

Analysis > Time Domain > Time Domain

Note

Time domain transformation function is accessible only in linear frequency sweep mode.

6.4.2 Time Domain Transformation Span

To define the span of time domain representation, you can set its start and stop, or center and span values.

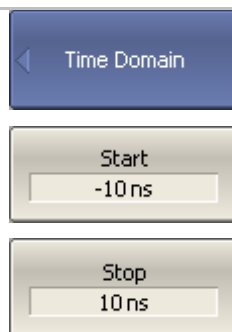

To set the start and stop limits of the time domain range, use the following softkeys:

Analysis > Time Domain > Start

Analysis > Time Domain > Stop

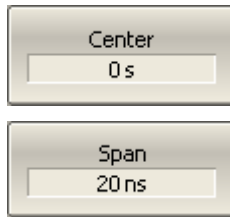

To set the center and span of the time domain, use the following softkeys:

Analysis > Time Domain > Center

Analysis > Time Domain > Span

6.4.3 Time Domain Transformation Type



To set the time domain transformation type, use the following softkeys:

Analysis > Time Domain > Type >

Bandpass | Lowpass Impulse | Lowpass Step

6.4.4 Time Domain Transformation Window Shape Setting

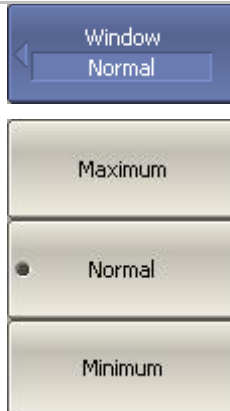

To set the window shape, use the following softkeys:

Analysis > Time Domain > Window >

Minimum | Normal | Maximum

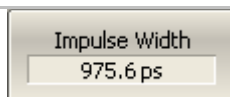

To set the window shape for the specific impulse width or front edge width, use the following softkeys:

Analysis > Time Domain > Window > Impulse Width

The setting values are limited by the specified frequency range. The bottom limit corresponds to the value implemented in the minimum (rectangular) window. The top limit corresponds to the value implemented in the maximum window.

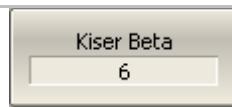

To set the window shape for the specific β -parameter of the Kaiser-Bessel filter, use the following softkeys:

Analysis > Time Domain > Window > Kaiser Beta

The available β values are from 0 to 13. 0 corresponds to minimum window, 6 corresponds to normal window, 13 corresponds to maximum widow.

Note

The impulse width and β of the Kaiser-Bessel filter are the dependent parameters. When you set one of the parameters the other one will be adjusted automatically.

6.4.5 Frequency Harmonic Grid Setting

If lowpass impulse or lowpass step transformation is enabled, the frequency range will be represented as a harmonic grid. The frequency values in measurement points are integer multiples of the start frequency F_{min} . The Analyzer is capable of creating a harmonic grid for the current frequency range automatically.



To create a harmonic grid for the current frequency range, use the following softkeys:

Analysis > Time Domain > Set Frequency Low Pass

Note

The frequency range will be transformed as follows:

$F_{max} > N \times 0.3 \text{ MHz}$	$F_{max} < N \times 0.3 \text{ MHz}$
$F_{min} = F_{max} / N$	$F_{min} = 0.3 \text{ MHz},$ $F_{max} = N \times 0.3 \text{ MHz}$

6.5 Time Domain Gating

Time domain gating is a function, which mathematically removes the unwanted responses in time domain. The function performs time domain transformation and applies reverse transformation back to frequency domain to the user-defined span in time domain. The function allows the user to remove spurious effects of the fixture devices from the frequency response, if the useful signal and spurious signal are separable in time domain.

Note	Use <i>time domain</i> function for viewing the layout of useful and spurious responses. Then enable <i>time domain gating</i> and set the gate span to remove as much of spurious response as possible. After that disable the time domain function and view the response without spurious effects in frequency domain.
------	--

The function involves two types of time domain gating:

- *bandpass* – removes the response outside the gate span,
- *notch* – removes the response inside the gate span.

The rectangular window shape in frequency domain leads to spurious sidelobes due to sharp signal changes at the limits of the window. The following gate shapes are offered to reduce the sidelobes:

- *maximum*;
- *wide*;
- *normal*;
- *minimum*.

The minimum window has the shape close to rectangular. The maximum window has more smoothed shape. From minimum to maximum window shape, the sidelobe level increases and the gate resolution reduces. The choice of the window shape is always a trade-off between the gate resolution and the level of spurious sidelobes. The parameters of different window shapes are represented in table 6.7.

Table 6.7 Time domain gating window shapes

Window Shape	Bandpass Sidelobe Level	Gate Resolution (Minimum Gate Span)
Minimum	- 48 dB	$\frac{2.8}{F_{\max} - F_{\min}}$
Normal	- 68 dB	$\frac{5.6}{F_{\max} - F_{\min}}$
Wide	- 57 dB	$\frac{8.8}{F_{\max} - F_{\min}}$
Maximum	- 70 dB	$\frac{25.4}{F_{\max} - F_{\min}}$

6.5.1 Time Domain Gate Activating

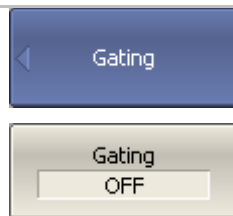

To enable/disable the time domain gating function: toggle the following softkey:

Analysis > Gating > Gating

Note

Time domain gating function is accessible only in linear frequency sweep mode.

6.5.2 Time Domain Gate Span

To define the span of time domain gate, you can set its start and stop, or center and span values.

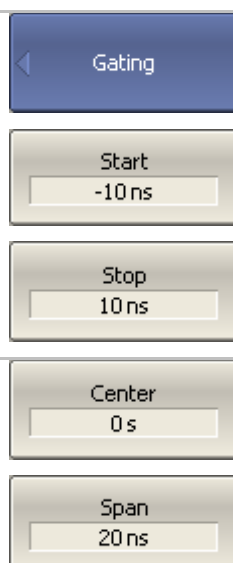

To the start and stop of the time domain gate, use the following softkeys:

Analysis > Gating > Start

Analysis > Gating > Stop

To set the center and span of the time domain gate, use the following softkeys:

Analysis > Gating > Center

Analysis > Gating > Span

6.5.3 Time Domain Gate Type

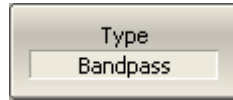
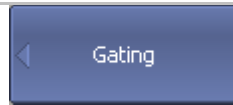

To select the type of the time domain window, use the following softkeys:

Analysis > Gating > Type

Toggle the type between **Bandpass** and **Notch**.

6.5.4 Time Domain Gate Shape Setting

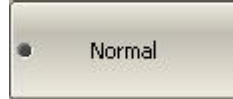
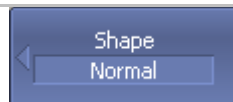

To set the time domain gate shape, use the following softkeys:

Analysis > Gating > Shape >

Minimum | Normal | Wide | Maximum

6.6 S-Parameter Conversion

S-parameter conversion function allows conversion of the measurement results (S_{ab}) to the following parameters:

- Equivalent impedance (Z_r) and equivalent admittance (Y_r) in reflection measurement:

$$Z_r = Z_{0a} \cdot \frac{1 + S_{ab}}{1 - S_{ab}}$$

$$Y_r = \frac{1}{Z_r}$$

- Equivalent impedance (Z_t) and equivalent admittance (Y_t) in transmission measurement:

$$Z_t = \frac{2 \cdot \sqrt{Z_{0a} \cdot Z_{0b}}}{S_{ab}} - (Z_{0a} + Z_{0b})$$

$$Y_t = \frac{1}{Z_t}$$

- Inverse S-parameter:

$$\left(\frac{1}{S_{ab}} \right)$$

- Equivalent impedance (Z_{tsh}) and equivalent admittance (Y_{tsh}) in transmission shunt measurements:

$$Z_{tsh} = \frac{1}{Y_{tsh}}$$

$$Y_{sh} = \frac{2 \cdot \sqrt{Y_{0a} \cdot Y_{0b}}}{Y_{ab}} - (Y_{0a} + Y_{0b})$$

$$Y_{0a} = \frac{1}{Z_{0a}}, \quad Y_{0b} = \frac{1}{Z_{0b}}$$

- S-parameter complex conjugate.







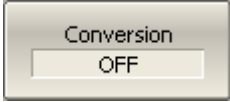

Where:

Z_{0a} – characteristic impedance of Port a,

Z_{0b} – characteristic impedance of Port b,

S_{ab} – measured S-parameter (a and b are the port numbers).

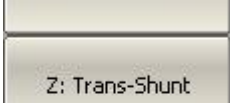
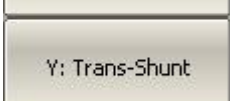
S-parameter conversion function can be applied to an individual trace of a channel. Before enabling the function, first activate the trace.

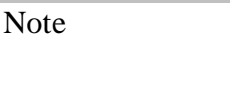
	<p>To enable/disable the conversion, use the following softkeys:</p>
	<p>Analysis > Conversion > Conversion</p>
	<p>To select the conversion type, use the following softkeys:</p>
	<p>Analysis > Conversion > Function > Zr: Reflection </p>
	<p>Zt: Transmission </p>
	<p>Yr: Reflection </p>
	<p>Yt: Transmission </p>
	<p>1/S: Inverse </p>
	<p>Ztsh: Trans-Shunt </p>
	<p>Ytsh: Trans-Shunt </p>
	<p>Conjugation</p>

Note All conversion types are indicated in the trace status field, if enabled.

6.7 Limit Test

The limit test is a function of automatic pass/fail judgment for the trace of the measurement result. The judgment is based on the comparison of the trace to the limit line set by the user.

The limit line can consist of one or several segments (See figure 6.15). Each segment checks the measurement value for failing whether upper or lower limit. The limit line segment is defined by specifying the coordinates of the beginning (X_0 , Y_0) and the end (X_1 , Y_1) of the segment, and type of the limit. The MAX or MIN limit types check if the trace falls outside of the upper or lower limit respectively.

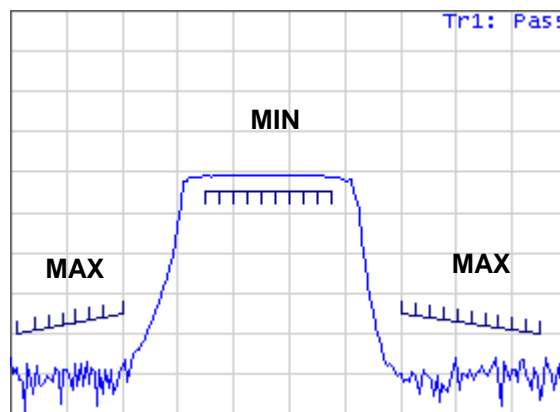

Figure 6.15 Limit line

The limit line is set by the user in the limit table. Each row in the table describes one segment of the line. Limit table editing is described below. The table can be saved into a *.lim file.

The display of the limit lines on the screen can be turned on/off independently of the status of the limit test function.

The result of the limit test is indicated in the upper right corner of the graph. If the measurement result passed the limit test, you will see the trace number and the result: **Tr1: Pass.**

If the measurement result failed, the result will be indicated in the following ways (See figure 6.16):

- **Tr1: Fail** will be displayed in upper right corner of the graph;
- **Fail** sign will be displayed in red in the center of the window;
- The points of the trace, which failed the test will be highlighted in red;
- You will hear a beep.

Fail sign and the beep can be disabled by the user. For beep deactivation see section 8.5.

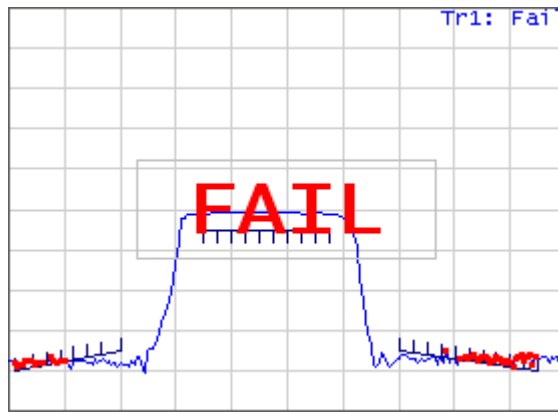
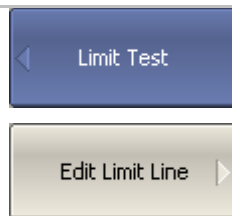

Figure 6.16 Test fail indication

6.7.1 Limit Line Editing



To access the limit line editing mode, use the following softkeys:

Analysis > Limit Test > Edit Limit Line

In the editing mode the limit table will appear in the lower part of the screen (See figure 6.17). The limit table will be hidden when you quit the submenu.

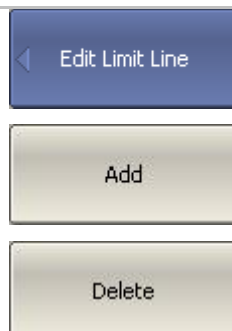

	Type	Begin Stimulus	End Stimulus	Begin Response	End Response
1	MAX	10 MHz	400 MHz	-100 dB	-90 dB
2	MIN	700 MHz	1.2 GHz	-6 dB	-6 dB
3	MAX	1.4 GHz	2 GHz	-90 dB	-100 dB
4					

Figure 6.17 Limit line table

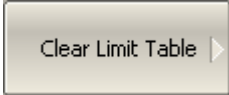
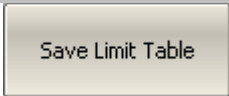

To add a new row in the table, click **Add**. The new row will appear below the highlighted one.

To delete a row from the table, click **Delete**. The highlighted row will be deleted.

	To clear the entire table, use Clear Limit Table softkey.
	To save the table into *.lim file, use Save Limit Table softkey.
	To open the table from a *.lim file, use Restore Limit Table softkey.

Navigating in the table to enter the values of the following parameters of a limit test segment:

Type	Select the segment type among the following: <ul style="list-style-type: none"> ▪ MAX – upper limit ▪ MIN – lower limit ▪ OFF — segment not used for the limit test
Begin Stimulus	Stimulus value in the beginning point of the segment.
End Stimulus	Stimulus value in the ending point of the segment.
Begin Response	Response value in the beginning point of the segment.
End Response	Response value in the ending point of the segment.

6.7.2 Limit Test Enabling/Disabling

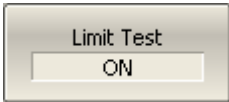
	To enable/disable limit test function, use the following softkeys:
	Analysis > Limit Test > Limit Test

6.7.3 Limit Test Display Management

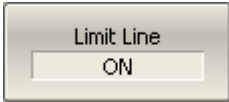
	To enable/disable display of a <i>limit line</i> , use the following softkeys:
	Analysis > Limit Test > Limit Line

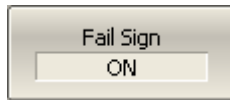

To enable/disable display of **Fail** sign in the center of the graph, use **Fail Sign** softkey.

6.7.4 Limit Line Offset

Limit line offset function allows the user to shift the segments of the limit line by the specified value along X and Y axes simultaneously.

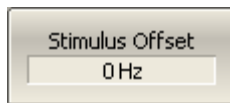
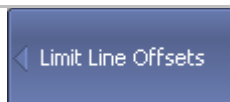

To define the limit line offset along X-axis, use the following softkeys:

Analysis > Limit Test > Limit Line Offsets > Stimulus Offset

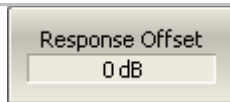

To define the limit line offset along Y-axis, use the following softkeys:

Analysis > Limit Test > Limit Line Offsets > Response Offset



Response offset can be set to the active marker position, using the following softkeys:

Analysis > Limit Test > Limit Line Offsets > Marker -> Response Ofs

6.8 Ripple Limit Test

Ripple limit test is an automatic pass/fail check of the measured trace data. The trace is checked against the maximum ripple value (*ripple limit*) defined by the user. The ripple value is the difference between the maximum and minimum response of the trace in the trace frequency band.

The ripple limit can include one or more segments (See figure 6.18). Each segment provides the ripple limit for the specific frequency band. A segment is set by the frequency band and the ripple limit value.

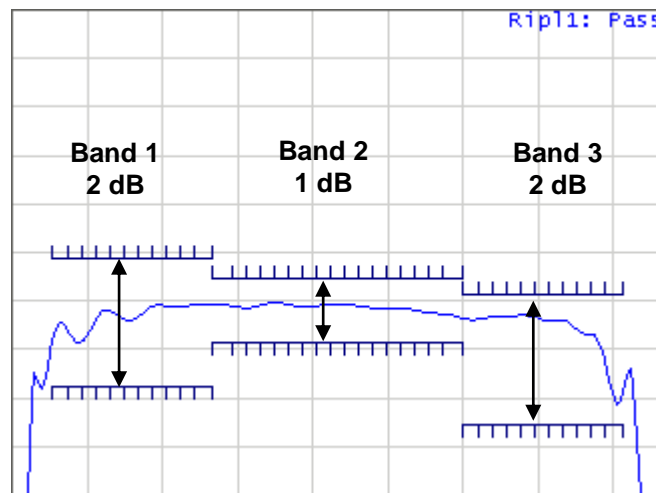

Figure 6.18 Ripple limits

The ripple limit settings are performed in the ripple limit table. Each row of the table describes the frequency band the ripple limit value. The ripple limit table editing is described below. The table can be saved into a *.lim file.

The display of the limit lines on the screen can be turned on/off by the user.

The result of the ripple limit test is indicated in the upper right corner of the graph. If the measurement result passed the limit test, you will see the trace number and the result: **Ripl1: Pass**.

If the measurement result failed, the result will be indicated in the following ways (See figure 6.19):

- **Ripl1: Fail** will be displayed in upper right corner of the graph;
- **Fail** sign will be displayed in red in the center of the window;
- You will hear a beep.

Fail sign and the beep can be disabled by the user. For beep deactivation see section 8.5.

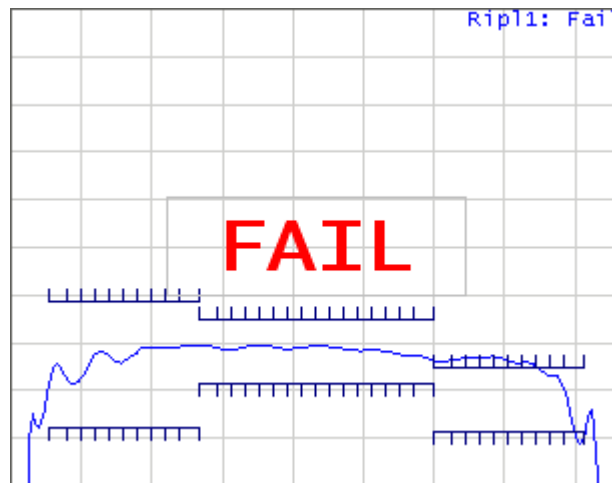

Figure 6.19 Test fail indication

The display of the ripple value can be enabled/disabled by the user in the ripple limit test status line in the upper right corner of the graph (See figure 6.20). The ripple value is displayed for the band selected by the user. The ripple value can be represented as an *absolute* value or as a *margin* to the limit.

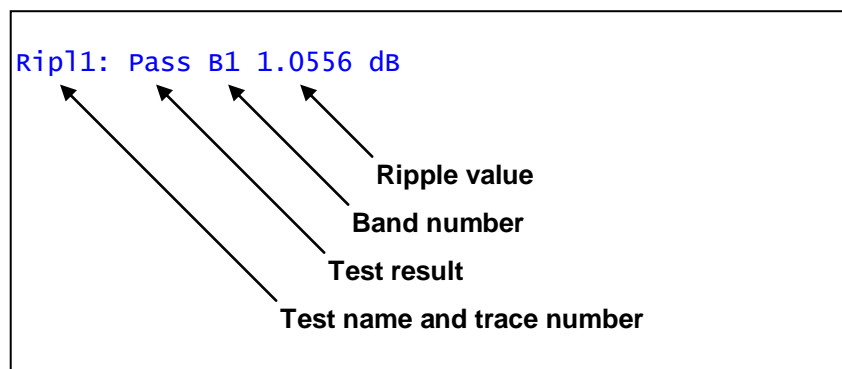

Figure 6.20 Ripple limit test status line





6.8.1 Ripple Limit Editing

	<p>To access the ripple limit editing mode, use the following softkeys:</p>
	<p>Analysis > Ripple Limit > Edit Ripple Limit</p>

In the editing mode the limit table will appear in the lower part of the screen (See figure 6.21). The limit table will be hidden when you quit the submenu.

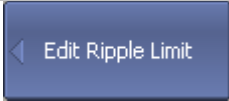
	Type	Begin Stimulus	End Stimulus	Ripple Limit
1	ON	640MHZ	800MHZ	4 dB
2	ON	800MHZ	1.05 GHZ	2 dB
3	ON	1.05 GHZ	1.21GHZ	3 dB
4				

Figure 6.21 Ripple limit table

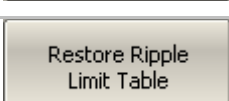
	To add a new row in the table, click Add . The new row will appear below the highlighted one.
	To delete a row from the table, click Delete . The highlighted row will be deleted.
	
	To clear the entire table, use Clear Ripple Limit Table softkey.
	To save the table into *.rlm file, use Save Ripple Limit Table softkey.
	To open the table from a *.rlm file, use Recall Ripple Limit Table softkey.

Navigating in the table to enter the values of the following parameters of a ripple limit test segment:

Type	Select the segment type among the following: <ul style="list-style-type: none"> ▪ ON – band used for the ripple limit test ▪ OFF — band not used for the limit test
Begin Stimulus	Stimulus value in the beginning point of the segment.
End Stimulus	Stimulus value in the ending point of the segment.
Ripple Limit	Ripple limit value.

6.8.2 Ripple Limit Enabling/Disabling

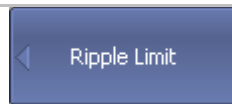

To enable/disable ripple limit test function, use the following softkeys:

Analysis > Ripple Limit > Ripple Test

6.8.3 Ripple Limit Test Display Management

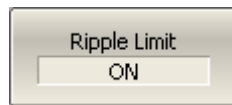
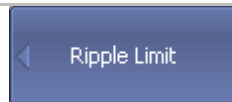

To enable/disable display of the *ripple limit line*, use the following softkeys:

Analysis > Ripple Limit > Ripple Limit

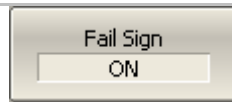

To enable/disable display of the **Fail** sign in the center of the graph, use the following softkeys:

Analysis > Ripple Limit > Fail Sign.



To enable/disable display of the ripple value, use the following softkeys:

Analysis > Ripple Limit > Ripple Value >

OFF | Absolute | Margin

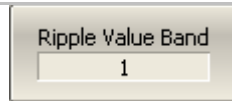

To enter the number of the band, whose ripple value should be displayed, use the following softkeys:

Analysis > Ripple Limit > Ripple Value Band

7 ANALYZER DATA OUTPUT

7.1 Analyzer State

The Analyzer state, calibration and measured data can be saved on the hard disk to an Analyzer state file and later uploaded back into the Analyzer program. The following four types of saving are available:

State	The Analyzer settings.
State & Cal	The Analyzer settings and the table of calibration coefficients.
State & Trace	The Analyzer settings and data traces ¹ .
All	The Analyzer settings, table of calibration coefficients, and data traces ¹ .

The Analyzer settings that become saved into the Analyzer state file are the parameters, which can be set in the following submenus of the softkey menu:

- All the parameters in **Stimulus** submenu;
- All the parameters in **Measurement** submenu;
- All the parameters in **Format** submenu;
- All the parameters in **Scale** submenu;
- All the parameters in **Average** submenu;
- All the parameters in **Display** submenu except for **Properties**;
- All the parameters of **Markers** submenu;
- All the parameters of **Analysis** submenu;
- **Ref Source** and **System Correction** parameters in **System** submenu.

To save and recall a state file, you can use ten softkeys labeled **State01**, ... **State10**. Each of the softkeys correspond to a *.sta file having the same name.



To have the Analyzer state automatically recalled after each start of the instrument use *Autorecall.sta* file. Use **Autorecall** softkey to save the corresponding file and thus enable this function.

¹ When recalling the state with saved data traces, the trigger mode will be automatically set to «Hold», so that the recalled traces are not erased by the currently measured data.





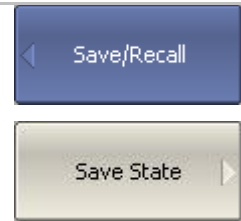

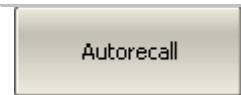
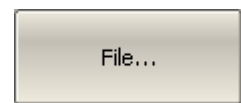
To disable the automatic recall of the Analyzer state, delete the *Autorecall.sta* file using the specific softkey.

You can save and recall the files with arbitrary names. For this purpose use **File...** softkey, which will open the **Save as** dialog box.

7.1.1 Analyzer State Saving

	<p>To set the type of saving, use the following softkeys:</p>
	<p>Save/Recall > Save Type > State State & Cal State & Trace All</p>
	<p>To save the state, use the following softkeys:</p>
	<p>Save/Recall > Save State</p>
	<p>To save a state into one of the ten files, use State01...State10 softkeys.</p>
	<p>A check mark in the left part of the softkey indicates that the state with the corresponding number is already saved.</p>
	<p>To save the state, which will be automatically recalled after each start of the Analyzer, use Autorecall softkey.</p>
	<p>A check mark on the softkey indicates that such a state is already saved.</p>
	<p>To save a state into the file with an arbitrary name use File... softkey.</p>

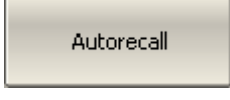
7.1.2 Analyzer State Recalling

	<p>To recall the state from a file of Analyzer state, use the following softkeys:</p>
	<p>Save/Recall > Recall State</p>
	<p>Click the required softkey of the available State01...State10.</p>
<p>...</p>	<p>If the state with some number was not saved the corresponding softkey will be grayed out.</p>
	
	<p>You can select the state automatic recall file by clicking Autorecall softkey.</p>
	<p>To recall a state from the file with an arbitrary name, use File... softkey.</p>

7.2 Channel State

A channel state can be saved into the Analyzer memory. The channel state saving procedure is similar to saving of the Analyzer state saving, and the same saving types (described in section 7.1) are applied to the channel state saving.



Unlike the Analyzer state, the channel state is saved into the Analyzer inner volatile memory (not to the hard disk) and is cleared when the power to the Analyzer is turned off. For channel state storage, there are four memory registers **A, B, C, D**.

The channel state saving allows the user to easily copy the settings of one channel to another one.

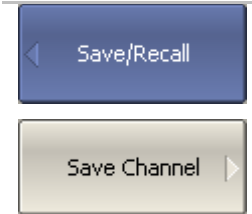
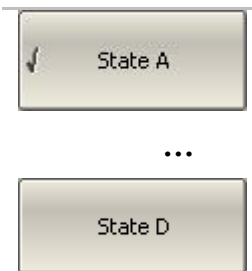
7.2.1 Channel State Saving

 <p>The image shows a vertical stack of softkeys. At the top is a blue softkey with a left-pointing arrow and the text 'Save/Recall'. Below it is a grey softkey with the text 'Save Channel' and a right-pointing arrow.</p>	<p>To save the active channel state, use the following softkeys:</p> <p>Save/Recall > Save Channel</p>
 <p>The image shows a vertical stack of softkeys. The top softkey is grey with a checkmark on the left and the text 'State A'. Below it are three dots '...', and at the bottom is a grey softkey with the text 'State D'.</p>	<p>To save a state into one of the four memory registers, use State A...State D softkeys.</p> <p>A check mark in the left part of the softkey indicates that the state with the corresponding number is already saved.</p>

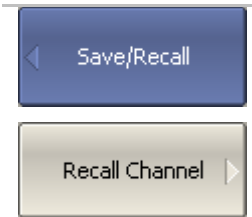
7.2.2 Channel State Recalling

 <p>The image shows a vertical stack of softkeys. At the top is a blue softkey with a left-pointing arrow and the text 'Save/Recall'. Below it is a grey softkey with the text 'Recall Channel' and a right-pointing arrow.</p>	<p>To recall the active channel state, use the following softkeys:</p> <p>Save/Recall > Recall Channel</p>
 <p>The image shows a vertical stack of softkeys. The top softkey is grey with the text 'State A'. Below it are three dots '...', and at the bottom is a grey softkey with the text 'State D'.</p>	<p>Click the required softkey of the available State A...State D.</p> <p>If the state with some number was not saved the corresponding softkey will be grayed out.</p>

7.3 Trace Data CSV File

The Analyzer allows the use to save an individual trace data as a CSV file (comma separated values). The *.CSV file contains digital data separated by commas. The active trace stimulus and response values in current format are saved to *.CSV file.

Only one (active) trace data are saved to the file.

The trace data are saved to *.CSV in the following format:

F[0],	Data1,	Data2
F[1],	Data1,	Data2
	...	
F[N],	Data1,	Data2

F[n] frequency at measurement point n;

Data1 trace response in rectangular format, real part in Smith chart and polar format;

Data2 zero in rectangular format, imaginary part in Smith chart and polar format.

7.3.1 CSV File Saving/Recalling

To save the trace data, first activate the trace.

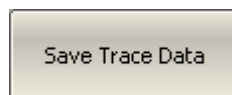

To save the trace data, use the following softkeys:

Save/Recall > Save Trace Data

Enter the file name in the dialog that appears.

7.4 Save Data to Touchstone File

The Analyzer allows saving S-parameters to a Touchstone file. The Touchstone file contains the frequency values and S-parameters. The files of this format are typical for most of circuit simulator programs.

The *.s1p files are used for saving S_{11} and S_{22} parameters of a 1-port device.

The *.s2p files are used for saving all the four S-parameters of a 2-port device.

The *.s3p files are used for saving all the four S-parameters of a 3-port device.

The *.s4p files are used for saving all the four S-parameters of a 4-port device.

Only one (active) channel data are saved to the file.

Note	For saving 2/3/4-port Touchstone files, all used ports have to be employed as a signal source. This is achieved by execution of full 2/3/4-port calibration in the channel, or availability of a sufficient number of S-parameters in the channel. For example, it is sufficient to have four traces S_{11} , S_{12} , S_{13} , S_{14} in the channel for the *.s4p file.
------	---

The Touchstone file saving function is applied to individual channels. To use this function, first activate the channel.

The Touchstone file contains comments, header, and trace data lines. Comments start with the «!» symbol. Header starts with the «#» symbol. Below are the Touchstone file formats.

The *.s1p Touchstone file format for 1-port measurements:

! Comments		
# Hz S FMT R Z0		
F[0]	{S ₁₁ }'	{S ₁₁ }"
	...	
F[N]	{S ₁₁ }'	{S ₁₁ }"

The *.s2p Touchstone file format for 2-port measurements:

! Comments								
# Hz S FMT R Z0								
F[0]	{S ₁₁ }'	{S ₁₁ }"	{S ₂₁ }'	{S ₂₁ }"	{S ₁₂ }'	{S ₁₂ }"	{S ₂₂ }'	{S ₂₂ }"
				...				
F[N]	{S ₁₁ }'	{S ₁₁ }"	{S ₂₁ }'	{S ₂₁ }"	{S ₁₂ }'	{S ₁₂ }"	{S ₂₂ }'	{S ₂₂ }"

The *.s3p Touchstone file format for 3-port measurements:

! Comments						
# Hz S FMT R Z0						
F[0]	{S ₁₁ }'	{S ₁₁ }"	{S ₁₂ }'	{S ₁₂ }"	{S ₁₃ }'	{S ₁₃ }"
	{S ₂₁ }'	{S ₂₁ }"	{S ₂₂ }'	{S ₂₂ }"	{S ₂₃ }'	{S ₂₃ }"
	{S ₃₁ }'	{S ₃₁ }"	{S ₃₂ }'	{S ₃₂ }"	{S ₃₃ }'	{S ₃₃ }"
				...		
F[N]	{S ₁₁ }'	{S ₁₁ }"	{S ₁₂ }'	{S ₁₂ }"	{S ₁₃ }'	{S ₁₃ }"
	{S ₂₁ }'	{S ₂₁ }"	{S ₂₂ }'	{S ₂₂ }"	{S ₂₃ }'	{S ₂₃ }"
	{S ₃₁ }'	{S ₃₁ }"	{S ₃₂ }'	{S ₃₂ }"	{S ₃₃ }'	{S ₃₃ }"

The *.s4p Touchstone file format for 4-port measurements:

! Comments								
# Hz S FMT R Z0								
F[0]	{S ₁₁ }'	{S ₁₁ }"	{S ₁₂ }'	{S ₁₂ }"	{S ₁₃ }'	{S ₁₃ }"	{S ₁₄ }'	{S ₁₄ }"
	{S ₂₁ }'	{S ₂₁ }"	{S ₂₂ }'	{S ₂₂ }"	{S ₂₃ }'	{S ₂₃ }"	{S ₂₄ }'	{S ₂₄ }"
	{S ₃₁ }'	{S ₃₁ }"	{S ₃₂ }'	{S ₃₂ }"	{S ₃₃ }'	{S ₃₃ }"	{S ₃₄ }'	{S ₃₄ }"
	{S ₄₁ }'	{S ₄₁ }"	{S ₄₂ }'	{S ₄₂ }"	{S ₄₃ }'	{S ₄₃ }"	{S ₄₄ }'	{S ₄₄ }"
				...				
F[N]	{S ₁₁ }'	{S ₁₁ }"	{S ₁₂ }'	{S ₁₂ }"	{S ₁₃ }'	{S ₁₃ }"	{S ₁₄ }'	{S ₁₄ }"
	{S ₂₁ }'	{S ₂₁ }"	{S ₂₂ }'	{S ₂₂ }"	{S ₂₃ }'	{S ₂₃ }"	{S ₂₄ }'	{S ₂₄ }"
	{S ₃₁ }'	{S ₃₁ }"	{S ₃₂ }'	{S ₃₂ }"	{S ₃₃ }'	{S ₃₃ }"	{S ₃₄ }'	{S ₃₄ }"
	{S ₄₁ }'	{S ₄₁ }"	{S ₄₂ }'	{S ₄₂ }"	{S ₄₃ }'	{S ₄₃ }"	{S ₄₄ }'	{S ₄₄ }"

Hz – frequency measurement units (**kHz**, **MHz**, **GHz**)

FMT – data format:





- **RI** – real and imaginary parts,
- **MA** – linear magnitude and phase in degrees,
- **DB** – logarithmic magnitude in dB and phase in degrees.

Z0 – reference impedance value

F[n] – frequency at measurement point n

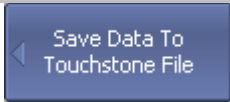
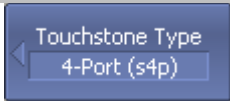
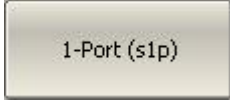
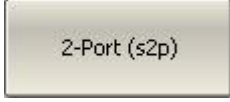
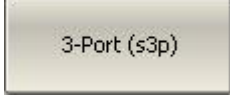
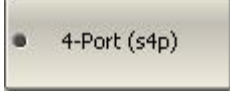
{...}' – {real part (RI) | linear magnitude (MA) | logarithmic magnitude (DB)}

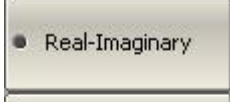
{...}" – {imaginary part (RI) | phase in degrees (MA) | phase in degrees (DB)}

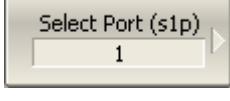
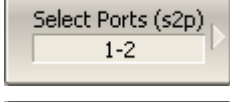
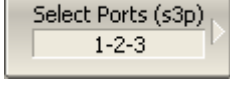
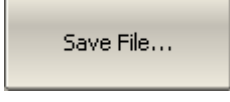



	<p>To select the menu for saving the Touchstone files, use the following softkeys:</p> <p>Save/Recall > Save Data To Touchstone File</p>
    	<p>Select the Touchstone file type using the following softkeys:</p> <p>Type ></p> <p>[1-Port (s1p) </p> <p>2-Port (s2p) </p> <p>3-Port (s3p) </p> <p>4-Port (s4p)]</p>
   	<p>To select the data format, use the following softkeys:</p> <p>Format ></p> <p>[Real-Imaginary </p> <p>Magnitude-Angle </p> <p>dB-Angle]</p>
  	<p>Select the port numbers for 1/2/3-port Touchstone file using the following softkeys:</p> <p>Select Port (s1p) > [1 2 3 4]</p> <p>Select Ports (s2p) > [1-2 1-3 1-4 2-3 2-4 3-4]</p> <p>Select Ports (s3p) > [1-2-3 1-2-4 1-3-4 2-3-4]</p>
	<p>To save the file to the disk drive use the softkey:</p> <p>Save File...</p> <p>Enter the file name in the dialog box.</p>

7.5 Touchstone File Recalling

The Analyzer allows recalling data from the Touchstone files. Data can be loaded to memory traces or data traces. When loading data to data traces, the analyzer switches to the hold mode to avoid writing current data over the recalled data. When loading data to the memory traces, the sweep hold does not occur.

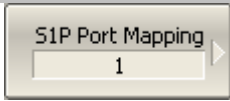
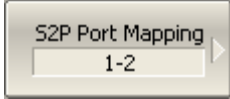
If the frequency scale of the Touchstone file does not correspond with the current analyzer frequency settings, the data is interpolated during recalling.

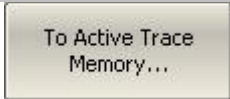
One/two/three-port Touchstone file can be mapped to the arbitrary analyzer ports, for example, the *.s2p file can be mapped to ports 3-4.

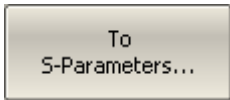
	<p>To select the Touchstone file recalling menu, use the following softkeys:</p> <p>Save/Recall > Load Data From Touchstone File</p>
  	<p>Select the one/two/three-port Touchstone file mapping using the following softkeys:</p> <p>S1P Port Mapping > [1 2 3 4]</p> <p>S2P Port Mapping > [1-2 1-3 1-4 2-3 2-4 3-4]</p> <p>S3P Port Mapping > [1-2-3 1-2-4 1-3-4 2-3-4]</p>
  	<p>Load the data from the Touchstone file using one of the softkeys:</p> <p>To Active Trace Memory – loading data to the active trace memory</p> <p>To All Traces Memory – loading data to the memory of all traces</p> <p>To S-parameters – loading data to all data traces of the channel.</p>

8 SYSTEM SETTINGS

8.1 Analyzer Presetting

Analyzer presetting feature allows the user to restore the default settings of the Analyzer.

The default settings of your Analyzer are specified in Appendix 1.



To preset the Analyzer, use the following softkeys:

System > Preset > OK

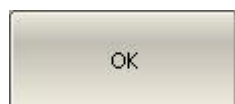

8.2 Graph Printing

This section describes the print/save procedures for the graph data.

The print function is provided with the preview feature, which allows the user to view the image to be printed on the screen, and/or save it to a file.

You can print out the graphs using three different applications:

- MS Word;
- Image Viewer for Windows;
- Print Wizard of the Analyzer.

Note	MS Word application must be installed in Windows system.
------	--

Note	The Print Wizard requires at least one printer to be installed in Windows.
------	--

You can select the print color before the image is transferred to the printing application:

- Color (no changes);
- Gray Scale;
- Black & White.

You can invert the image before it is transferred to the printing application.

You can add current date and time before the image is transferred to the printing application.



To print a graph, use the following softkeys:

System > Print

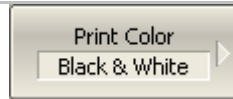

Select the print color, using **Print Color** softkey:

- **Color**
- **Gray Scale**
- **Black & White**

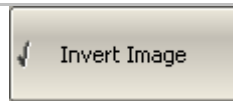

If necessary, invert the image by **Invert Image** softkey.

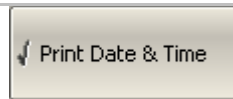

If necessary, select printing of date and time by **Print Date & Time** softkey.

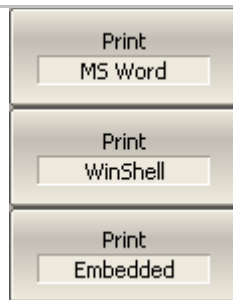

Then select the printing application, using one of the following softkeys:

- **Print: MS Word**
- **Print: Windows**
- **Print: Embedded**

8.3 Reference Frequency Oscillator Selection

The Analyzer can operate either with internal or with external reference frequency (10 MHz) oscillator. Initially the Analyzer is set to operation with the internal source of the reference frequency.

You can switch between these two modes in the softkey menu.

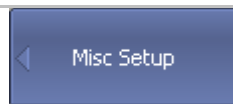

To select the reference frequency oscillator, use the following softkeys:

System > Misc Setup > Ref Source

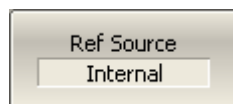

8.4 System Correction Setting

The Analyzer is supplied from the manufacturer calibrated with the calibration coefficients stored in its non-volatile memory. The factory calibration is used by default for initial correction of the measured S-parameters. Such calibration is referred to as system calibration, and the error correction is referred to as system correction.

The system correction ensures initial values of the measured S-parameters before the Analyzer is calibrated by the user. The system calibration is performed at the plane of the port physical connectors and leaves out of account the cables and other fixture used to connect the DUT. The measurement accuracy of the Analyzer without its calibration with the user setup is not rated.

Normally, the disabling of the system correction **is not required** for a calibration and further measurements.

To execute the performance test you need to disable the system correction function. The performance test determines raw port characteristics, such as directivity, matching and tracking.

If the system correction is disabled by the user, this is indicated in the instrument status bar.



To disable/enable the system correction, use the following softkeys:

System > Misc Setup > System Correction

8.5 Beeper Setting

The Analyzer features two settings of the beeper, which can be toggled on/off independently from each other:

- *operation complete beeper* – informs the user about normal completion of standard measurements during calibration;
- *warning beeper* – informs the user about an error or a fail limit test result.

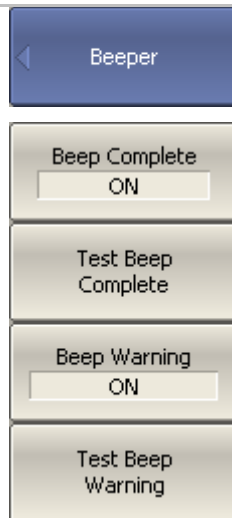

To toggle the beeper, use the following softkeys:

System > Misc Setup > Beeper > Beep Complete

System > Misc Setup > Beeper > Beep Warning

To test the beeper, use the following softkeys:

System > Misc Setup > Beeper > Test Beep Complete

System > Misc Setup > Beeper > Test Beep Warning

8.6 User Interface Setting

The Analyzer enables you to make the following user interface settings:

- Toggle between full screen and window display
- Set color of:
 - Data traces
 - Memory traces
 - Background and grid of graph
 - Background and font of menu bar
- Style and width of:
 - Data traces
 - Memory traces
 - Graph grid
- Font size of:
 - Softkeys
 - Channel window



To change the color of the background of the graph, use the following softkeys:

Display > Properties > Color > Background

Then select the rate (from 0 to 255) of color components.



To change the color of the grid of the graph, use the following softkeys:

Display > Properties > Color > Grid

Then select the rate (from 0 to 255) of color components.

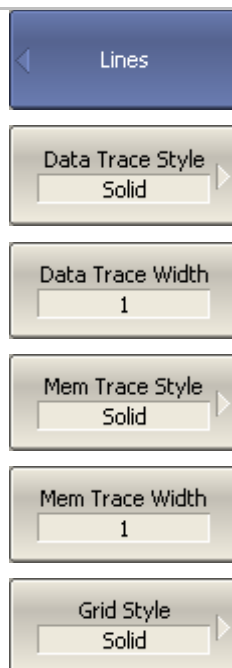

To change the style and width of a data trace, use the following softkeys:

Display > Properties > Lines > Data Trace Style

Display > Properties > Lines > Data Trace Width

To change the style and width of a memory trace, use the following softkeys:

Display > Properties > Lines > Mem Trace Style

Display > Properties > Lines > Mem Trace Width

To change the grid style, the following softkeys:

Display > Properties > Lines > Grid Style

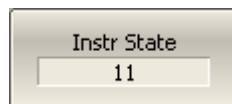
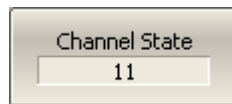

To change the font size on the softkeys, in the channel window, in the channel status bar, or the instrument status bar, use the following softkeys:

Display > Properties > Font Size > Softkeys

Display > Properties > Font Size > Window Channel

Display > Properties > Font Size > Channel State

Display > Properties > Font Size > Instr State

Then select the font size from 10 to 13.

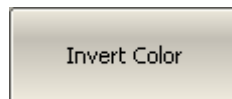
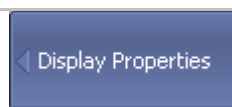

To invert the color of the graph area, use the following softkeys:

Display > Properties > Invert Color

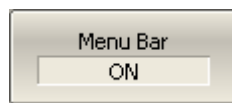

To hide/show the menu bar, use the following softkeys:

Display > Properties > Menu Bar

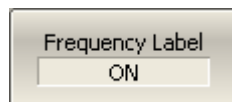
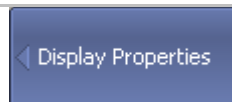

To hide/show stimulus graticule (X axis), use the following softkeys:

Display > Properties > Frequency Label

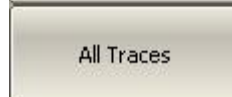
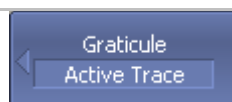

To set the response graticule label mode (Y axis), use the following softkeys:

Display > Properties > Graticule Label>

OFF | Active Trace | All Traces



To restore the default factory settings, use the following softkeys:

Display > Properties > Set Defaults

8.7 Screen Update Setting

Screen updating can be disabled to reduce the sweep time. This function can be useful during remote control over the Analyzer via COM/DCOM interfaces.

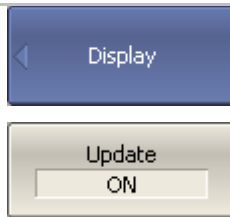

To disable the screen updating, use the following softkeys:

Display > Update

Note

If the screen updating is off, this will be indicated in the instrument status bar **Update Off**.

8.8 Power Meter Setting

An external power meter can be connected to the Analyzer to perform power calibration of the test ports. Connect the power meter to USB port or via USB/GPIB adapter. Then install the power meter software. The list of the power meters supported by the Analyzer is shown in table 8.1.

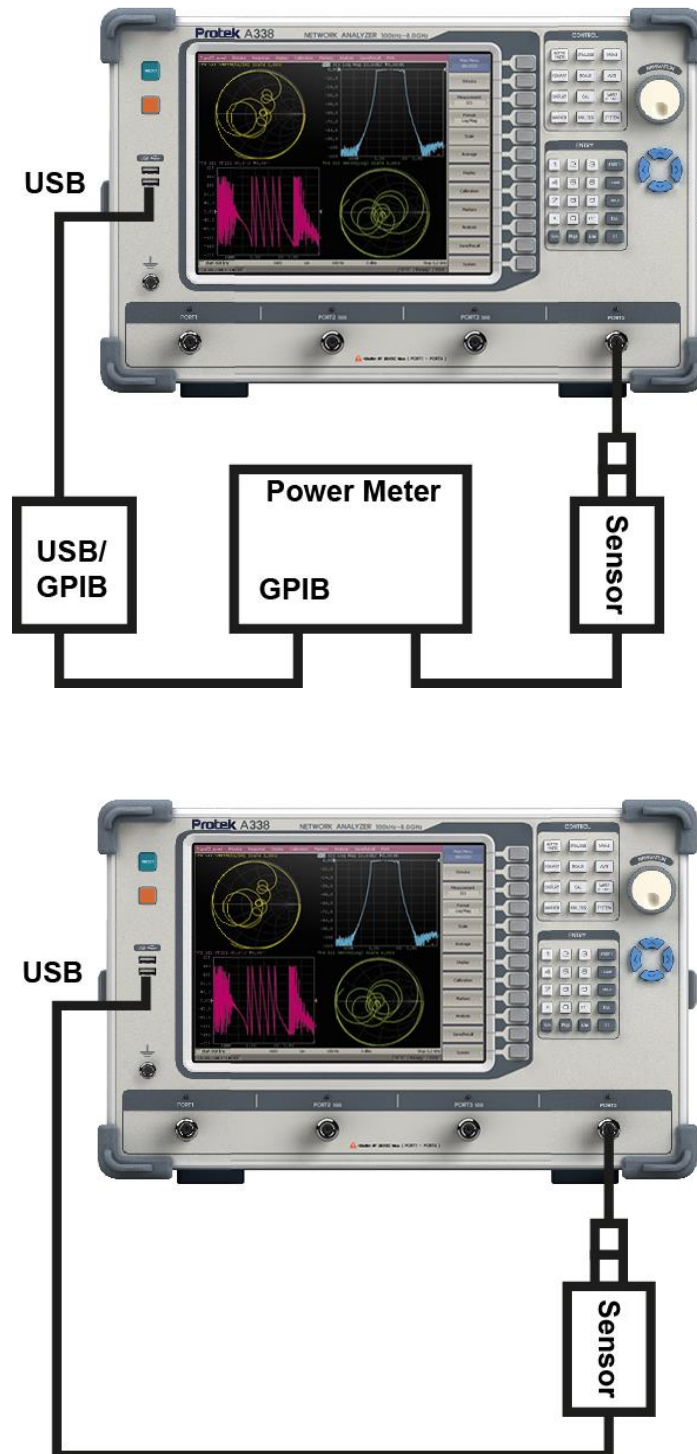
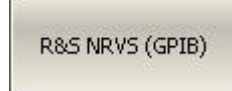

Figure 8.1 Power meter setup example

Table 8.1 Supported power meters

Power Meter	Name in Analyzer Program	USB Connection Type	Additional Software
Rohde&Schwarz NRP-Z series Sensors (without Power Meter) NRP-Z51 (recommended)	R&S NRP-Z sensors	R&S NRP-Z4 Adapter	<ul style="list-style-type: none"> ■ Rohde&Schwarz NRP-Toolkit (NRP-Toolkit) ■ Rohde&Schwarz RSNRPZ Instrument driver (rsnrpz_vxipnp)
Rohde&Schwarz NRVS Power Meter and NRV-Z51 or NRV-Z4 Sensors	R&S NRVS	GPIB/USB Adapter	<ul style="list-style-type: none"> ■ GPIB/USB Adapter driver ■ VISA visa32.dll Library



To select the power meter, use the following softkeys:

System > Misc Setup > Power Meter Setup > Power Meter > R&S NRP-Z sensors (USB) | R&S NRVS (GPIB)

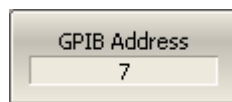
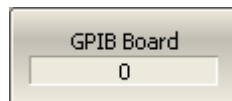

If the power meter has GPIB interface, set the GPIB board address and the power meter address in the bus, using the following softkeys:

System > Misc Setup > Power Meter Setup > GPIB Board

System > Misc Setup > Power Meter Setup > GPIB Address

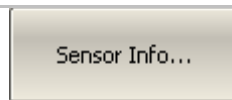

Sensor Info... softkey checks the connection and settings of the power meter. It provides sensor type, if the communication between the Analyzer and the power meter has been successfully established.

8.9 Stimulus Frequency Adjustment

This function provides fine adjustment of the stimulus frequency by means of an external frequency meter. By setting the stimulus frequency adjustment coefficient from -128 to +127, you can perform relative adjustment of the frequency within $\pm 0.001\%$ (typical value). This setting will be saved in the nonvolatile memory of the Analyzer. The function adjusts the frequency of the internal reference frequency oscillator, so to adjust the frequency over all the operating frequency range, it is sufficient to perform the adjustment in one frequency point.

To adjust the stimulus frequency, proceed as follows:

Switch the Analyzer on and warm it up to the operating temperature for 40 minutes;

Connect the frequency meter to the output connector of the internal reference frequency (10 MHz) oscillator or to one of the Analyzer test ports;

If you connect the frequency meter to a test port of the Analyzer, set this test port to the CW-frequency output operation.

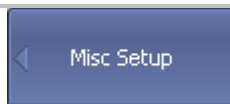

To access the stimulus frequency adjustment function, use the following softkeys:

System > Misc Setup > Frequency Adjustment...

In the pop-up dialog, set the stimulus frequency adjustment coefficient, which ensures the value measured by the frequency meter being closest to the output frequency of the Analyzer. Save this coefficient to the nonvolatile memory by clicking **Save** softkey.

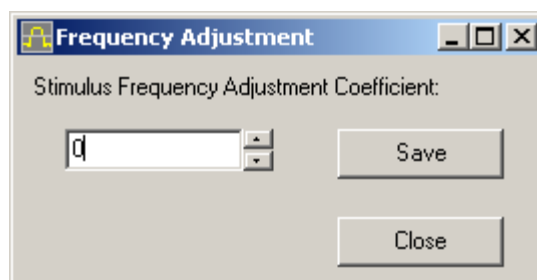

9 MAINTENANCE AND STORAGE

9.1 Maintenance Procedures

This section describes the guidelines and procedures of maintenance, which will ensure fault-free operation of your Analyzer.

The maintenance of the Analyzer consists in cleaning of the instrument, factory calibrations, and regular performance tests.

9.1.1 Instrument Cleaning

This section provides the cleaning instructions required for maintaining the proper operation of your Analyzer.

To remove contamination from parts other than test ports and any connectors of the Analyzer, wipe them gently with a soft cloth that is dry or wetted with a small amount of water and wrung tightly.

It is essential to keep the test ports always clean as any dust or stains on them can significantly affect the measurement capabilities of the instrument. To clean the test ports (as well as other connectors of the Analyzer), use the following procedure:

- using compressed air remove or loosen the contamination particles;
- clean the connectors using a lint-free cleaning cloth wetted with a small amount of ethanol and isopropyl alcohol (when cleaning a female connector, avoid snagging the cloth on the center conductor contact fingers by using short strokes);
- dry the connector with low-pressure compressed air.

Always completely dry a connector before using it.

Never use water or abrasives for cleaning any connectors of the Analyzer.

Do not allow contact of alcohol to the surface of the insulators of the connectors.

When connecting male-female coaxial connectors always use a calibrated wrench.

WARNING

Never perform cleaning of the instrument if the power cable is connected to the power outlet.

Never clean the internal components of the instrument.

9.1.2 Factory Calibration

Factory calibration is a regular calibration performed by the manufacturer or an authorized service center. We recommend you to send your Analyzer for factory calibration every three years.

9.1.3 Performance Test

Performance test is the procedure of the Analyzer performance verification by confirming that the behavior of the instrument meets the published specifications.

Performance test of the Analyzer should be performed in accordance with *Performance Test Instructions*.

The Analyzer software is provided with **System > Performance Test** submenu for automatic verification execution.

Performance test period is one year.

9.2 Storage Instructions

Before first use, store your Analyzer in the factory package at environment temperature from 0 to +40 °C and relative humidity up to 80% (at 25 °C).

After you have removed the factory package, store the Analyzer at environment temperature from +10 to +35 °C and relative humidity up to 80% (at 25 °C).

Ensure to keep the storage facilities free from dust, fumes of acids and alkalies, aggressive gases, and other chemicals, which can cause corrosion.

10 WARRANTY INFORMATION

1. The manufacturer warrants the Network Analyzer to conform to the specifications of this Manual when used in accordance with the regulations of operation detailed in this Manual.
2. The manufacturer will repair or replace without charge, at its option, any Analyzer found defective in manufacture within the warranty period, which is twelve (12) months from the date of purchase. Should the user fail to submit the warranty card appropriately certified by the seller with its stamp and date of purchase the warranty period will be determined by the date of manufacture.
3. The warranty is considered void if:
 - a) the defect or damage is caused by improper storage, misuse, neglect, inadequate maintenance, or accident;
 - b) the product is tampered with, modified or repaired by an unauthorized party;
 - c) the product's seals are tampered with;
 - d) the product has mechanical damage.
4. The batteries are not included or covered by this warranty.
5. Transport risks and costs to and from the manufacturer or the authorized service centers are sustained by the buyer.
6. The manufacturer is not liable for direct or indirect damage of any kind to people or goods caused by the use of the product and/or suspension of use due to eventual repairs.
7. When returning the faulty product please include the accurate details of this product and clear description of the fault. The manufacturer reserves the right to check the product in its laboratories to verify the foundation of the claim.



Technical Support

GS Instruments Co., Ltd
1385-14 Juan-dong Nam-ku
Incheon, Republic of Korea
402-200

Tel: +82-32-870-5656
E-mail: as@gsinstrument.com

Appendix 1 — Default Settings Table

Default values defined in the process of the initial factory setup.

Parameter Description	Default Setting	Parameter Setting Object
Data Saving Type	State and Calibration	Analyzer
Touchstone Data Format	Real-Imaginary	Analyzer
Allocation of Channels		Analyzer
Active Channel Number	1	Analyzer
Marker Value Identification Capacity (Stimulus)	7 digits	Analyzer
Marker Value Identification Capacity (Response)	4 digits	Analyzer
Marker Table	OFF	Analyzer
Reference Frequency Source	Internal	Analyzer
Trigger Signal Source	Internal	Analyzer
Reference Channel Error Correction	ON	Analyzer
System Correction	ON	Analyzer
Allocation of Traces		Channel
Vertical Divisions	10	Channel
Channel Title Bar	OFF	Channel
Channel Title	Empty	Channel
«FAIL» Label Display (Limit Test)	OFF	Channel
Segment Sweep Frequency Axis Display	Frequency Order	Channel
Traces per Channel	1	Channel
Active Trace Number	1	Channel
Marker Coupling	ON	Channel
Sweep Type	Linear Frequency	Channel
Number of Sweep Points	201	Channel
Stimulus Start Frequency	300 kHz	Channel
Stimulus Stop Frequency	8.0 GHz	Channel
Stimulus CW Frequency	300 kHz	Channel
Stimulus Start Power Level	-60 dBm	Channel
Stimulus Stop Power Level	10 dBm	Channel
Stimulus Power Level	0 dBm	Channel

Stimulus Power Slope	0 dBm	Channel
Stimulus IF Bandwidth	10 kHz	Channel
Sweep Measurement Delay	0 sec.	Channel
Sweep Range Setting	Start / Stop	Channel
Number of Segments	1	Channel
Points per Segment	2	Channel
Segment Start Frequency	300 kHz	Channel
Segment Stop Frequency	300 kHz	Channel
Segment Sweep Power Level	0 dBm	Channel
Segment Sweep IF Bandwidth	10 kHz	Channel
Segment Sweep Measurement Delay	0 sec.	Channel
Segment Sweep Power Level (Table Display)	OFF	Channel
Segment Sweep IF Bandwidth (Table Display)	OFF	Channel
Segment Sweep Measurement Delay (Table Display)	OFF	Channel
Segment Sweep Range Setting	Start / Stop	Channel
Averaging	OFF	Channel
Averaging Factor	10	Channel
Trigger Mode	Continuous	Channel
Table of Calibration Coefficients	Empty	Channel
Error Correction	OFF	Channel
Port Z Conversion	OFF	Channel
Port 1 Simulated Impedance	50 Ω	Channel
Port 2 Simulated Impedance	50 Ω	Channel
Port 1 De-embedding	OFF	Channel
Port 2 De-embedding	OFF	Channel
Port 1 De-embedding S-parameter File	Empty	Channel
Port 2 De-embedding S-parameter File	Empty	Channel
Port 1 Embedding	OFF	Channel
Port 2 Embedding	OFF	Channel
Port 1 Embedding User File	Empty	Channel
Port 2 Embedding User File	Empty	Channel
Measurement Parameter	S ₁₁	Trace
Trace Scale	10 dB / Div.	Trace
Reference Level Value	0 dB	Trace
Reference Level Position	5 Div.	Trace
Data Math	OFF	Trace

Phase Offset	0°	Trace
Electrical Delay	0 sec.	Trace
S-parameter Conversion	OFF	Trace
S-parameter Conversion Function	Z: Reflection	Trace
Trace Display Format	Logarithmic Magnitude (dB)	Trace
Time Domain Transformation	OFF	Trace
Time Domain Transformation Start	-10 nsec.	Trace
Time Domain Transformation Stop	10 nsec.	Trace
Time Domain Kaiser-Beta	6	Trace
Time Domain Transformation Type	Bandpass	Trace
Time Domain Gate	ON	Trace
Time Domain Gate Start	-10 ns	Trace
Time Domain Gate Stop	10 ns	Trace
Time Domain Gate Type	Bandpass	Trace
Time Domain Gate Shape	Normal	Trace
Smoothing	OFF	Trace
Smoothing Aperture	1%	Trace
Trace Display Mode	Data	Trace
Limit Test	OFF	Trace
Limit Line Display	OFF	Trace
Defined Limit Lines	Empty	Trace
Number of Markers	0	Trace
Marker Position	300 kHz	Trace
Marker Search	Maximum	Trace
Marker Tracking	OFF	Trace
Marker Search Target	0 dB	Trace
Marker Search Target Transition	Both	Trace
Marker Search Peak Polarity	Positive	Trace
Marker Search Peak Excursion	3 dB	Trace
Bandwidth Parameter Search	OFF	Trace
Marker Search Bandwidth Value	-3 dB	Trace
Marker Search Range	OFF	Trace
Marker Search Start	0	Trace
Marker Search Stop	0	Trace