



JD740A Series Analyzers



JD745A
Base Station Analyzer

JD746A
RF Analyzer

JD748A
Signal Analyzer

User's Manual

Introduction

In the wireless service industry, mobile communication service providers are continuously facing the critical need of reducing field maintenance and operation costs to deal with ever increasing competition. The JD740A series analyzers are the solutions to this need by integrating all the functions to diagnose base stations into a single field portable test solution. The JD740A series consists of Base Station Analyzer (JD745A), RF Analyzer (JD746A), and Signal Analyzer (JD748A). The JD740A series analyzers make service and maintenance activities on a base station easier, simpler, and faster by performing all complicated test and measurement processes through just a few key strokes.

In this Chapter

| | |
|--|---|
| JD740A Series Highlights | 4 |
| Functions | 4 |
| Applicable Systems | 4 |
| Safety Information | 5 |
| Safety Symbols | 5 |
| Safety Consideration | 5 |
| Input Power | 5 |
| Battery | 6 |
| Electrostatic Discharge Precautions (ESD)..... | 7 |
| Using Automotive Cigarette Lighter 12VDC Adapter | 8 |

(Rev. 6.0)

JD740A SERIES HIGHLIGHTS

The JD740A series is the optimal test solution for installation and maintenance of cellular base stations and cell sites, running with external AC power or internal battery for field applications.

The user interface of the JD740A series has been specifically designed with customized menus and simple calibration procedures, providing service providers with accurate and reliable measurement results.

Functions

| Functions | JD745A Base Station Analyzer | JD746A RF Analyzer | JD748A Signal Analyzer |
|--|------------------------------------|-----------------------|---------------------------|
| Spectrum Analyzer (100 kHz to 4 GHz) | n | n | n |
| Cable and Antenna Analyzer (5 MHz to 4 GHz) | n | n | |
| RF Power Meter (10 MHz to 4 GHz) | n | n | n |
| Optical Power Meter (optional) | n | n | n |
| Signal Analyzer (optional) | n | | n |
| E1/T1 Analyzer (optional) | n | | |
| Interference Analyzer (optional) | n | n | n |
| Channel Scanner (optional) | n | n | n |
| OTA Analyzer (optional) | n | | n |

Applicable Systems

- n cdmaOne/cdma2000
- n EV-DO
- n WCDMA/HSDPA
- n GSM/GPRS/EDGE
- n TD-SCDMA
- n WiMAX
- n LTE (FDD/TDD)

SAFETY INFORMATION

Safety Symbols

The following symbols must be observed for the proper operation of this instrument.



WARNING denotes a hazard. It calls for attention to a procedure or practice which, if not performed correctly, could result in a personal injury. Do not proceed beyond a WARNING indication until all the conditions are fully understood and met.



CAUTION denotes a caution. It calls for attention to a procedure or practice which, if not performed correctly, could result in a partial or total damage of this instrument. Do not proceed beyond a CAUTION indication until all the conditions are fully understood and met.



NOTICE denotes additional information or direction of operation of this instrument.

Safety Consideration



This product is a Safety Class I product. The main power plug shall only be inserted in a power socket outlet provided with a protective ground terminal.

Only the AC/DC power adapter supplied shall be used. JDSU is not liable for any personal injury or product damage caused by using a different power supply.



Removal of internal or external protective cover may cause personal injury or damage to this instrument. JDSU is not liable for any incident caused by unauthorized removal of such protective parts.

Input Power

There is no need to select the input voltage within the tolerable input line voltage range (AC 100-240V). This instrument does not have a separate line protection fuse.

| Item | Specification |
|-----------------------------------|--|
| Adapter Input Voltage & Frequency | 100-240 VAC, 50-60 Hz |
| Power Consumption | Operation 33 W Operation with charging 60 W |

Input Power Requirements

| | |
|---|--|
|  | Only the AC/DC power adapter supplied with this instrument shall be used. JDSU is not liable for any damage to the product caused by using a different power supply. |
|  | Always use three prong AC power cord supplied with this instrument. Failure to ensure adequate grounding by not using this power cord may cause personal injury or product damage. |
|  | The battery installed in this instrument is Lithium-Ion and it may lead to explosion if not connected correctly. In case the battery needs to be exchanged, it must be of the same type or compatible. The disposal of batteries must be done accordingly to safety and environmental regulations. |

Battery

The battery pack that comes with the instrument is Lithium-Ion and it may lead to explosion if not connected correctly. In case the battery needs to be replaced, it must be one of the same kinds or compatible ones. Disposal of the batteries must be done according to local safety and environmental regulations.



SAFETY GUIDE

- n Do not expose the battery to high temperature such as fire, heat, direct sun.
- n Do not connect the positive and negative terminals of the battery with any metal objects such as wires, paper clips, etc.
- n Do not expose the battery to any type of liquid such as rain, water and salt water to avoid getting wet.
- n Do not disassemble or modify the battery.



STORAGE GUIDE

Lithium-Ion batteries continue to slowly discharge (self-discharge) when stored or not in use for a while. In that case, you need to:

- n Remove the battery pack and store it separately from the product in a cool and dry location without direct sun light on the pack or its carton box.
- n Store the battery at temperatures between 10 °C and 30 °C (50 °F and 86 °F) to minimize the deactivation effect of the battery.
- n Storage at the temperatures above 30 °C or 86 °F reduces the battery storage life.
- n Charge at least once per 6 months to prevent leakage and deterioration in performance caused by self-discharging.

BATTERY CHARGE STATUS INDICATOR

You can find the battery charge indicator on the battery pack that shows you the status of battery charge.



Off, Blink, On

| Indicator | Description |
|-----------|---|
| | Voltage < 9.0V, immediate charge required |
| | Remaining Capacity Alarm, immediate charge required |
| | 1 to 19% Remaining, charge before storage |
| | 21 to 40% Remaining, charge before storage |
| | 41 to 60% Remaining, charge before storage |
| | 61 to 80% Remaining |
| | 81 to 100% Remaining |

Electrostatic Discharge Precautions (ESD)

This instrument was manufactured in an ESD protected environment. Semiconductor devices used in this product are susceptible to damage by static discharge. Depending on the magnitude of the discharge, semiconductor devices may be damaged by direct contact or mere proximity of a static charge. This may cause performance degradation, early failure or immediate destruction. Use the following guidelines to prevent ESD damage.

- n Before connecting a cable to this instrument terminal, short circuit the center of the cable with an outside metal shield.
- n Before removing a connected cable or getting in contact with the center pin, wear a wrist strap with 1 MΩ resistor connected to the ground.

- n All equipment must be connected to the ground to avoid accumulation of static charges.

Using Automotive Cigarette Lighter 12VDC Adapter

When using the Automotive Cigarette Lighter 12VDC Adapter, always verify that the supply is rated for a minimum of 60 Watts@12 VDC and that the socket is clear of any dirt or debris. If the adapter plug gets hot to touch during operation, discontinue the use immediately.

Getting Started

In this Chapter

| | |
|--|----|
| Unpacking the JD740A Series..... | 2 |
| Damage Inspection | 2 |
| JD740A Series Standard Accessories | 2 |
| Front Panel | 3 |
| Front Panel View | 3 |
| Front Panel Keys..... | 3 |
| Top Panel..... | 10 |
| Top Panel View | 10 |
| Top Panel Ports..... | 10 |
| Installing Battery Pack..... | 12 |

(Rev. 6.0)

UNPACKING THE JD740A SERIES

Damage Inspection

Unpack and inspect the shipping container thoroughly to ensure that nothing was damaged during shipment. If the contents are damaged or defective, contact your nearest JDSU's authorized sales and service office. Keep the shipping materials for carrier's inspection.

Verify if all the parts were included in the shipping container. The basic test set package of this instrument includes followings. If there are missing items, contact your nearest JDSU's authorized sales and service office.

- n JD740A Series Instrument (JD745A Base Station Analyzer, JD746A RF Analyzer, or JD748A Signal Analyzer)
- n JD740A Series Standard Accessories

JD740A Series Standard Accessories

| Part No. | Quantity | Description |
|------------|----------|---|
| G710550326 | 1 | AC/DC Power Adapter |
| G710550335 | 1 | Cross LAN Cable (1.5 m) |
| GC73050515 | 1 | USB A to B Cable (1.8 m) |
| GC72450518 | 1 | > 1 G Byte USB Memory |
| G710550325 | 1 | Rechargeable Lithium Ion Battery |
| G710550323 | 1 | Automotive Cigarette Lighter 12 VCD Adapter |
| JD740A361 | 1 | JD740A Series User's Manual and Application Software – CD |

NOTE: Refer to the **Ordering Information** in the Appendix for optional accessories.

FRONT PANEL

Front Panel View

This front panel view is the one of JD745A Base Station Analyzer's. The JD746A RF Analyzer and the JD748A Signal Analyzer of the JD740A series share the same front panel view as this.



JD745A/JD746A/JD748A Front Panel View

Front Panel Keys

POWER BUTTON AND LEDS

The power button is used to turn the JD740A series on and off. When the external power is connected through the AC/DC adapter, the upper LED which is the external power indicator is lit into orange color.

- n **POWER ON:** Press the button for about 3 seconds. When the JD740A series is turned on, the lower green LED indicator is lit.
- n **POWER OFF:** Press the button for about 3 seconds. When the JD740A series is turned off, the lower green LED indicator goes out.

FUNCTION HARD KEYS



These 7 function hard keys are used to activate particular functions as labeled on each key. Pressing a function hard key changes a set of screen menu on the display to function-specific menus and parameters associated with the key label.

- n **MODE:** Displays menus of the major function modes of the JD740A series, depending on specific instruments (JD745A, JD746A, or JD748A).



| Mode Menu | JD745A Base Station Analyzer | JD746A RF Analyzer | JD748A Signal Analyzer |
|--------------------------|------------------------------------|-----------------------|---------------------------|
| Spectrum Analyzer | n | n | n |
| Interference Analyzer | n | n | n |
| Signal Analyzer | n | | n |
| Channel Scanner | n | n | n |
| Power Meter | n | n | n |
| Cable & Antenna Analyzer | n | n | |
| E/T1 Analyzer | n | | |

- n **FREQ/DIST:** Displays menus of frequency setting parameters.
- n **AMP/SCALE:** Displays menus of amplitude and scale setting parameters.
- n **BW/AVG:** Displays menus of bandwidth and average setting parameters.
- n **TRACE/DISPLAY:** Displays menus of trace and display setting parameters.
- n **MARKER:** Displays menus of marker setting parameters.
- n **PEAK SEARCH:** Displays menus of peak search parameters.

HOT KEYS

When the user input window on the screen is inactive, the 10 hot keys are used to activate functions as labeled on each key. These hot keys do not function when the user input window is activated or highlighted on the measurement screen for numeric inputs. Pressing the ESC hard key cancels or deactivates the user input window so that the user can use these hot keys.

- n **MEASURE:**  Displays menus of measurements available for the particular measurement modes.

- n **MEASURE SETUP:**  Displays menus in conjunction with the Measure hard key.
- n **SAVE/LOAD:**  Displays menus of save or load setting parameters.
- Y **SAVE:** Measurement results can be saved either as graphic files or as data files. All measurement results can be saved as graphic files. Spectrum measurement results can also be saved as data files.
 - **SAVE SCREEN:** Saves current screen into a JPEG file. The file name can be assigned by the user. If the file name is not assigned by the user, then the instrument will automatically assign it based on the measurement mode and the measurement time.
 - **SAVE RESULT:** Saves a captured trace into a file. Traces can be saved with a file extension *.spa in the Spectrum Analyzer mode and *.tra in the Cable and Antenna Analyzer mode. This soft key can also be used to save measurement setup and results of Auto Measure as a *.gsr file in the Signal Analyzer mode. The user setup (Input Attenuation, RBW, VBW, Offset, Average, etc.) is not saved.
 - **SAVE SETUP:** Saves the user setup configuration (Input Attenuation, RBW, VBW, Offset, Average, etc.) and the calibration data.
 - **SAVE TO:** Selects where to save the screen, result, or setup: either the internal memory or an external USB memory.
- Y **LOAD:** Displays menus of load setting parameters.
 - **LOAD SCREEN:** Recalls and displays a saved screen. The active measurement continues to be measured, but it is not displayed on the screen. Pressing PREV key removes the loaded screen and the active measurement is displayed.
 - **LOAD RESULT:** Recalls multiple traces for trace comparison or single trace for trace overview. When the JD745A Base Station Analyzer or the JD746A RF Analyzer is in the Cable and Antenna Analyzer mode, recalling a saved result automatically changes followings.
 - o The trace with the different X-scale unit may not be seen on the screen. Therefore, the frequency or distance setting of the instrument must be matched to the trace to be loaded. And measurement modes of the instrument must be matched to the trace to be loaded.
 - o The Y scale unit is adjusted automatically to fit into the Y scale of the recalled trace. In the Spectrum Analyzer mode, start and stop frequencies or center frequency and span of the instrument must be matched to the trace to be loaded.
 - **LOAD SETUP:** Recalls a user setup configuration and the calibration data.

- **LOAD FROM:** Selects where the information to be recalled: either the internal memory or an external USB memory.

n **SWEEP:**  Displays menus of sweep setting parameters.

n **TRIGGER:**  Displays menus of trigger options including internal, external, and GPS.

n **SYSTEM:**  Displays menus of system setting parameters including system information.

Y **FREQUENCY REFERENCE:** Sets the frequency references to improve measurement accuracy. The frequency reference can be selected among Internal, External 10 MHz, External 13 MHz, External 15 MHz, or GPS.

Y **LANGUAGE:** Changes the system language for menus, messages and information on the display screen.

Y **POWER ON:** Selects the instrument power-on options. Each time the **Power On** soft key is pressed, the selection changes.

- **LAST:** Boots the instrument with the previous mode that has been on right before the last power-off or shut-down of the instrument.

- **FACTORY:** Boots with the factory default state. This allows the instrument to be returned to the settings recommended by the factory. This button may be used when the settings get badly misadjusted.

- **USER:** Boots the instrument with a user-defined mode, which is retrieved in the **User Status** menu.

Y **USER SETUP:** Selects a file (.gst) from the list of user-defined modes in order to boot the instrument with the selected mode. This soft key is activated only when the Power On option is set to User.

Y **DATE/TIME:** Sets the time of the system clock.

- **DATE FORMAT:** Each time the **Date Format** soft key is pressed, the selection changes to **YMD** to **MDY** and to **DMY**.

- **SET DATE:** Sets the date. Enter an 8-digit number depending on the date format selected. If the YMD format is selected, enter the 4 digits of the year first followed by another 2 digits for the month and then 2 digits for the day. For example, if today is February 3, 2010, input **20100203** and press the **Enter** soft key.

- **SET TIME:** Sets the time. Enter a 6-digit number in 24 hour format of hh:mm:ss. For an example, if the time is 5:30:30 in the afternoon, input **173030** and then press the **Enter** soft key.





Y **SOUND:** Activates or deactivates the beep sound that is audible when the front panel keys

are pressed and adjusts sound volume.

- Y **UPGRADE:** Upgrades the firmware of the instrument.
- Y **LICENSE MANAGER:** Selects optional modules that are activated by entering the corresponding license number.
 - **INSTALLED OPTIONS:** Shows options and descriptions installed in the instrument.
 - **INSTALLABLE OPTIONS:** Shows available options that can be installed in the instrument.
 - **INSTALL AN OPTION:** Enables a selected option by entering a license number.
- Y **LAN:** Sets the **Static** or **DHCP Mode**, **IP Address**, **Net Mask**, **Gateway**, **Ethernet Test**, and **LMF Settings** for Ethernet communication. Includes a dot when entering an address for IP Address, Net Mask, or Gateway. Pressing the **Apply** soft key completes the LAN setting. The Local Maintenance Facility (LMF) setting is used in order to perform TX Calibration and TX Audit on Motorola's CDMA/EV-DO BTS in the RF Power Meter mode. Refer to Appendix E - Motorola CDMA/EV-DO LMF for more information.
- Y **DISPLAY SETTINGS:** Changes display settings.
 - **SCREEN SAVER:** Sets the time to enter into power saving mode. When no key entry occurs for the set time, the instrument goes into the power saving mode automatically. Enter a number between 0 and 255 minutes using the numeric keys and then press the **Enter** soft key. Setting time to 0 turns the power saving mode off.
 - **BRIGHTNESS:** Adjusts the brightness of the LCD display from 0 to 100%. The brightness is set to 100% by default. Enter a number with the numeric keys to change it and then press the **Enter** soft key.
- Y **FILE MANAGER:** File manager provides following menu to copy or delete the data of the instrument.
 - **RESULT:** Saves the measurement result (traces, data, etc).
 - **SCREEN:** Saves the measurement into a graphic file.
 - **SETUP:** Saves the current instrument's setting or status.

When one of the above types is selected, the following sub-menu helps you save or manage measurements file more convenient.

- **COPY TO USB:** Copies the selected file to USB memory device.
- **COPY ALL TO USB:** Copies all files from the instrument to USB memory device.
- **PAGE UP:** Moves to the previous page.
- **PAGE DOWN:** Moves to the next page.
- **DELETE:** Deletes the selected file.
- **DELETE ALL:** Deletes all files saved in the instrument.

- n **PRESET:**  Returns the instrument to a known state to make measurements.
- n **HOLD:**  Changes the sweep mode to the Continue or the Single mode. Pressing the Hold hot key changes the sweep mode to the Single and the red HOLD sign is displayed on the screen. Pressing the Hold hot key again changes the sweep mode back to the Continue and the red HOLD sign goes out.
- n **LIMIT:**  Displays menus of limit setting parameters including display line, multi segment line, save limits, and recall limits or test specification limits.
- n **BACKLIGHT KEY:**  Sets the key backlight to On or Off. When the Backlight is set to On, pressing any keys turns the key backlight on and the backlighting stays on for about 10 seconds.
- n **HELP:**  Displays online help.

ESC

This key is used either to deactivate the user input window so that any hot keys can be used or to get any pop-up window on the screen disappeared.

PREV

This key is used to return to the previous menu without changing current setups. Each time this key is pressed, the screen menu keeps going back to the previous ones up until the Measure screen menu, which is the initial screen menu of the current mode.

SOFT KEYS

These 7 soft keys with no labels are used to activate a particular function, to invoke other screen keys, or to input specific value units. They are arranged next to the screen menus on the display. Selecting a soft key will darken the color of its accompanying screen menu to show its selection. In case the screen menus are more than seven for the same menu layer, the **More** screen menu will be displayed at the bottom of the screen menu bar. The small arrow-head (|) symbol on the right upper corner of a screen menu indicates the existence of additional screen menus under the menu layer.

ROTARY KNOB WITH ENTER BUTTON AND ARROW KEYS



- n **ROTARY KNOB:** Allows incremental value changes by predefined steps for settings such as carrier frequency, span, reference level, attenuation, external offset, or averaging or to move a marker on the trace. Rotating the knob clockwise increases the value or moves the marker to the right and rotating the knob counter clockwise decreases the value or moves the marker to the left. The incremental step values are set differently for each function. The rotary knob scrolls through the characters in a pop-up keyboard screen in save button and is pressed to select each character in sequence.

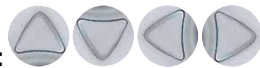

- n **ARROW KEYS:** The up/down/left/right arrow keys increase or decrease active function values. They work similarly as the rotary knob.

DATA ENTRY KEYS



- n **NUMERIC KEYS:** These numeric keys work when the user input window on the screen is activated for data entry. They are used to enter values for test parameters. The value entered by the user is displayed in the user input window on the screen.



- n **DEL:** Deletes the input values. Every time when the DEL key is pressed, it deletes the last value entered. The DEL key cannot remove values entered after the Enter key or the Unit screen menu is selected.



- n **ENTER:** Confirms entry of input values without a specific unit. Pressing the rotary knob works as the same. When entered value requires a specific unit, screen menus are displayed on the screen to show available units that can be selected by pressing the corresponding soft key to the screen menu.



SPEAKER

The speaker generates audible sounds for alarms and key selections when the sound mode is on in the **System** function.

TOP PANEL

Top Panel View

This top panel view is the one of the JD745A Base Station Analyzer. The JD746A RF Analyzer shares the same top panel view with the JD745A except for the E1/T1 inlet. Instead of it, the JD746A has the GPIO inlet as like the JD748A Signal Analyzer.

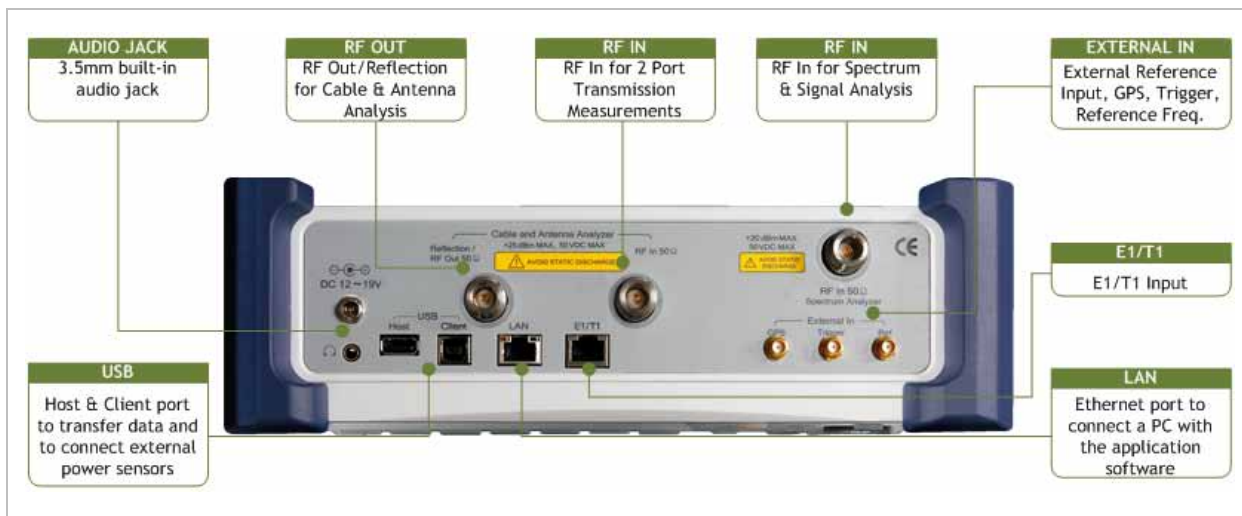

JD745A/JD746 Top Panel View

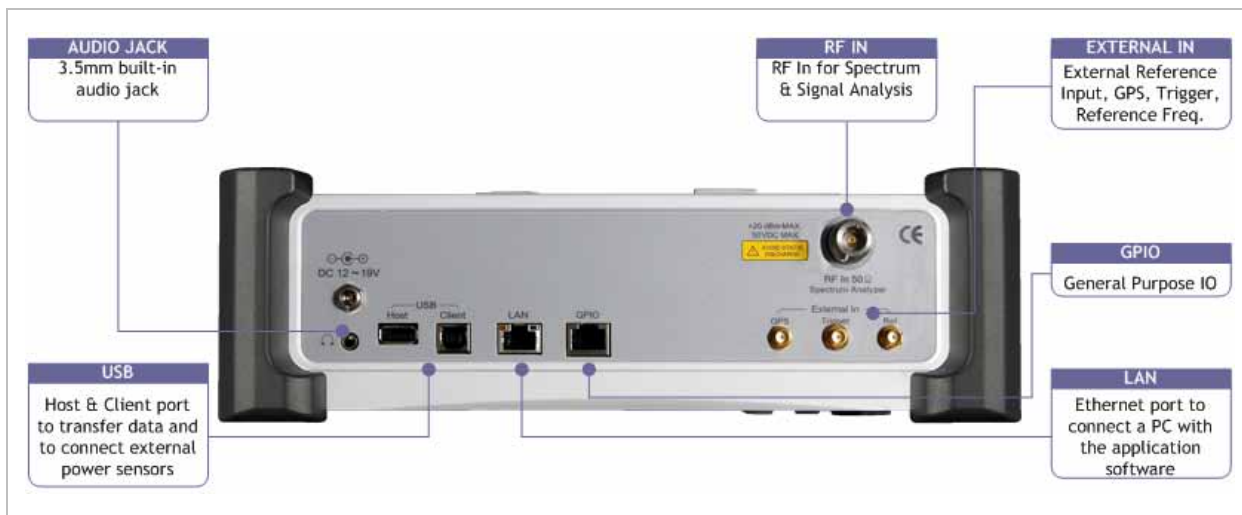

JD748A Top Panel View

Top Panel Ports

REFLECTION/RF OUT 50 Ω (CABLE AND ANTENNA ANALYZER)

The Reflection/RF Out 50 Ω port of the Cable and Antenna Analyzer is a precise 50 ohm N-type

female connector that is used as the output signal port for the Cable and Antenna Analyzer mode.



Do not apply or connect power exceeding +25 dBm to this Reflection/RF Out port. If the power is applied, it will degrade the product performance and can damage the product in worst case.

RF IN 50 Ω (CABLE AND ANTENNA ANALYZER)

The RF In 50 Ω port is a precise 50 ohm N-type female connector that is used as the input signal port for insertion gain/loss measurements in the Cable and Antenna Analyzer mode.



The maximum power for this RF In port is +25 dBm. If the input power exceeds the maximum allowable limit, it will degrade the product performance and can damage the instrument in worst case. Do not connect any power feed exceeding 1 W directly to this RF In port of the instrument.

DC 12 ~ 19V IN

The DC input power range shall be from 12 to 19V for this input port.

RF IN 50 Ω (SPECTRUM ANALYZER)

The RF In 50 Ω port is a precise 50 ohm N-type female connector that is used as the input signal port for spectrum analysis, signal analysis, and RF power measurement.



The maximum power for this RF In port is +20 dBm. If the input power exceeds the maximum allowable limit, it will degrade the product performance and can damage the instrument in worst case. Do not connect any power feed exceeding 0.1 W directly to this RF In port of the instrument.

AUDIO JACK

The audio jack is labeled with a headphones icon. When headphones or earphones are plugged in, the sound to the speaker in the front panel is usually muted.

USB

n **CLIENT:** Communication port to connect a PC with the application software JDViewer installed.

- n **HOST:** The USB 1.1 host port is used to plug in an external USB memory to extend the instrument's storage capacity or to upgrade the instrument's firmware. It supports most USB memory devices with 32-bit file system. This port is also used to connect external power sensor devices that are available separately for terminating or directional power measurements.

LAN

The Ethernet communication port is used to connect a PC with the application software JDViewer or Motorola WinLMF if applicable. Connect a LAN cable to this Ethernet connector and to the PC. When the Ethernet connection is done, check the indicator LEDs next to the Ethernet connector for status.

- n **ACTIVITY:** The yellow LED is lit during data transfer activity.
- n **LINK:** The green LED is lit when there is a valid communication connection.

E1/T1

The E1/T1 input port of the JD745A Base Station Analyzer is used to detect error or alarm from E1/T1 signal and to transmit test pattern to E1/T1 transmission line that is connected through the provided RJ45 cable accessory.

GPIO

The General Purpose Input/Output (GPIO) port of the JD746A RF Analyzer and the JD748A Signal Analyzer can be used for debugging errors.

EXTERNAL IN

- n **GPS:** Is a SMA type female connector that is used for GPS antenna providing location information and highly accurate reference.
- n **TRIGGER:** Is a SMA type female connector that is used to receive PP2S clock or 10 msec synchronization signals from an external timing reference.
- n **REF:** Is a SMA type female connector that is used to receive 10 MHz, 13 MHz, or 15 MHz reference clock signals from an external frequency source.

INSTALLING BATTERY PACK

You need to install the included Lithium-Ion battery pack that comes in the shipping container. Removing the battery is just reverse order of what you are instructed here to install it.

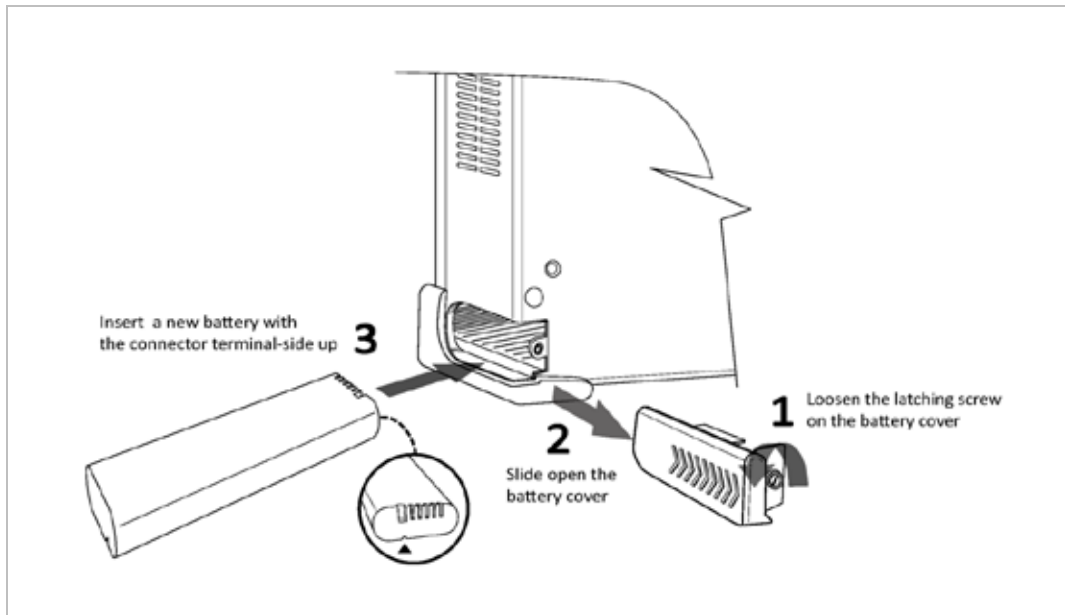

Battery Installation Guide

Procedure

1. Loosen the latching screw of the battery cover by turning counter clockwise.
2. Slide open the battery cover.
3. Insert the battery pack with the connector terminal side up and push in until it stops.
4. Slide close the battery cover.
5. Tighten the latching screw of the battery cover by turning clockwise.



The battery pack that comes with the instrument is Lithium-Ion and it may lead to explosion if not connected correctly. In case the battery needs to be replaced, it must be one of the same kinds or compatible ones. Disposal of the batteries must be done accordingly to safety and environmental regulations.

Spectrum Analyzer

This Spectrum Analyzer function is one of the standard features that the JD740A Series provides. It enables to verify the presence of unwanted signals such as spurious and harmonics, which are normally very hard to identify in Time domain analysis.

In this Chapter

| | |
|--------------------------------------|----|
| Using Spectrum Analyzer | 3 |
| Display Overview..... | 3 |
| Connecting a Cable | 5 |
| Direct Connection..... | 5 |
| Indirect Connection | 6 |
| Spectrum Analysis Measurements | 6 |
| Setting Mode | 6 |
| Setting Frequency | 7 |
| Setting Amplitude | 9 |
| Setting Bandwidth | 10 |
| Setting Averaging | 11 |
| Setting Sweep | 12 |
| Setting Trigger..... | 14 |
| Setting Trace and Display | 14 |
| Setting RF Source..... | 15 |
| Setting Event Save..... | 15 |
| Setting Limit | 16 |
| Measurement Example | 19 |
| RF Analysis Measurements..... | 19 |
| Setting Mode | 20 |
| Setting Frequency | 20 |
| Setting Amplitude | 22 |
| Setting Bandwidth | 24 |
| Setting Averaging | 25 |
| Setting Sweep | 25 |
| Setting Trace and Display | 27 |
| Setting RF Source..... | 28 |
| Setting Event Save..... | 28 |
| Channel Power | 29 |
| Measurement Procedure | 29 |
| Measurement Example | 31 |
| Occupied Bandwidth..... | 32 |
| Measurement Procedure | 32 |
| Measurement Example | 33 |
| Spectrum Emission Mask (SEM)..... | 34 |
| Measurement Procedure | 34 |

Measurement Example 36

Adjacent Channel Power (ACP) 36

 Measurement Procedure 37

 Measurement Example 38

Spurious Emissions 39

 Measurement Procedure 39

 Measurement Example 41

AM/FM Audio Demodulation 42

 Measurement Procedure 42

 Setting Limit 44

 Measurement Example 44

Field Strength Meter 45

 Measurement Procedure 45

 Setting Limit 46

 Measurement Example 47

Route Map 48

 Measurement Procedure 48

 Setting Limit 50

 Measurement Example 51

Analysis 51

 Using Marker 51

 Using Peak Search 53

(Rev. 6.0)

USING SPECTRUM ANALYZER

The advantage of using the Spectrum Analyzer is easy to verify the presence of unwanted signals such as spurious and harmonics, which are normally very hard to identify in time domain analysis. Performance assurance in wireless communication systems includes the observation of the out-of-band signal characteristics in order to identify the presence of harmonic signals. Harmonic signals of a carrier may interfere with other signals far out of the transmission band, or harmonic signals from other transmitter may interfere with in band signals affecting the spectral integrity.

In these days when wide variety of wireless communication services are provided in frequency bands assigned very closely to each other, it is critical to ensure that each communication service is carried out within their assigned frequency band minimizing interference with adjacent frequency bands. The Adjacent Channel Power Ratio (ACPR) characteristic of a power amplifier or other RF components is an important factor in evaluating the system performance.

The JD740A series is the optimum solution to perform following measurements.

- n Spectrum Analysis
- n RF Analysis
 - Y Channel Power
 - Y Occupied Bandwidth
 - Y Spectrum Emission Mask
 - Y Adjacent Channel Power (ACP)
 - Y Spurious Emissions
 - Y AM/FM Audio Demodulation
 - Y Field Strength
 - Y Route Map

DISPLAY OVERVIEW

Measurement Mode Information: Spectrum Analyzer

Spectrum Input Level Setting Information: This window shows the most common settings or parameters of each measurement.

- Frequency and Channel Setting
- Amplitude Setting (Preamp, Attenuation, External Offset)
- Reference Setting (Frequency, Trigger)

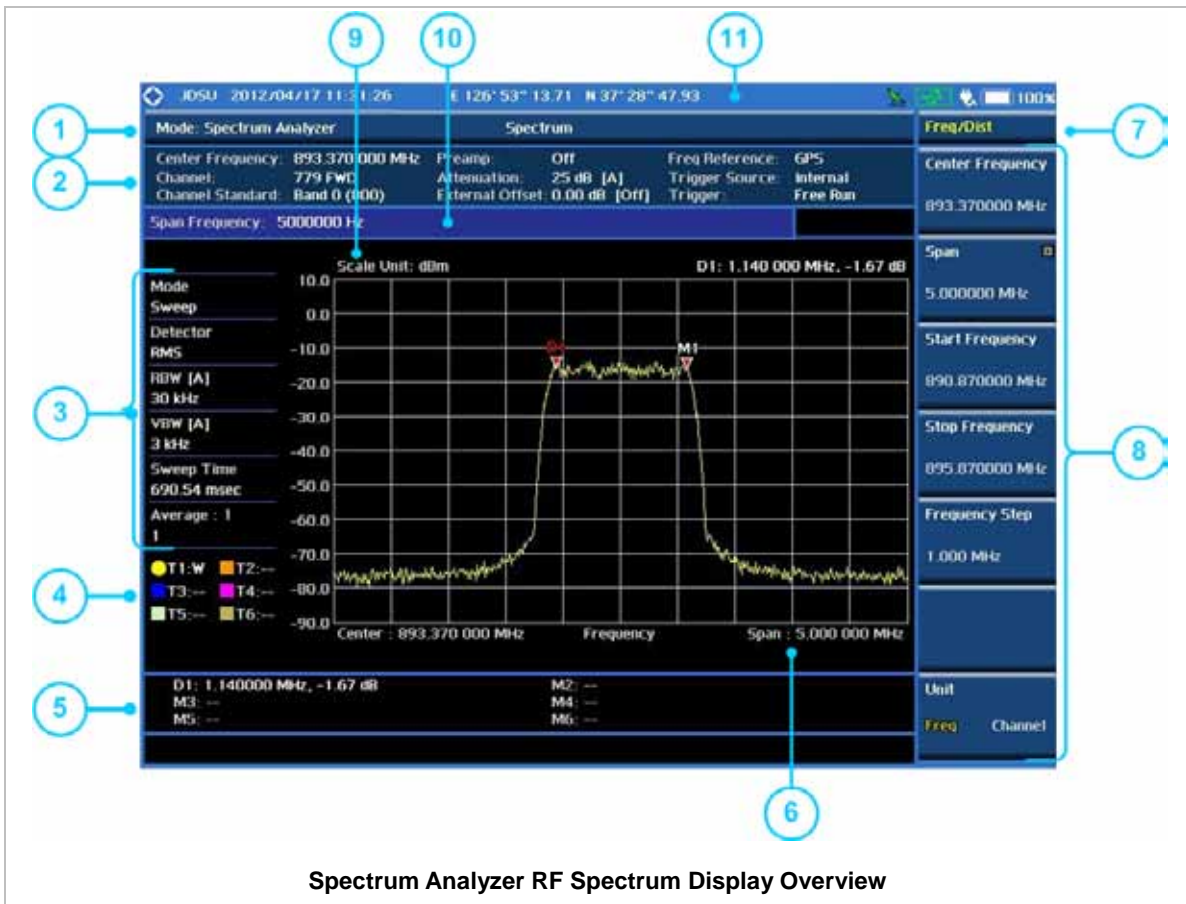

Measurement Setting Information

- Spectrum Analyzer Operation Mode Information
- Detector Type Setting Information
- Spectrum Setting Information (RBW, VBW)
[A]: Auto mode, [M]: Manual mode
- Sweep Time Information: Displays current sweep time
- Average Number Information set through BW/AVG hard key. It shows the number of traces to be averaged.

Trace Information

- C: Captured
- M: Max Hold
- m: Min Hold
- W: Write Current Trace (Indicates current active trace)
- L: Loaded
- F: Trace View Off

Information on Marker Table displays up to 6 markers

Span Setting Information which is set by span menu through FREQ/DISP hard key, there are two types of Y-scale display. Display will change to start and stop frequency when user set the span using start and stop frequency.

Screen Menu Title

Screen Menu and Sub-menu

Scale Unit Information: dBm, dBV, dBmV, dBuV, V, and W

User Input Window: Activates when user input menu or key is selected. Pressing ESC hard key will cancel or deactivate user input window. Inactivate user input window before using hot keys.

NOTE: It is very important to inactivate the user input window when you intend to use the hot key menu on the numeric keys.

System Information

- Date and Time
- Positioning Information (Longitude and Latitude). It is available only when a GPS antenna is connected. Frequency reference is automatically set to GPS in the System menu when a GPS antenna is connected.
- Frequency Reference Indicator: INT for internal and EXT for external. The EXT icon is green when an external reference is locked or red when the external reference is not locked. When a GPS antenna is connected, this space will be blank.
- GPS Indicator: Color of the GPS icon changes among green, yellow and gray depending on locking status.
- USB Indicator
- DC Input Power Indicator
- Battery Indicator

CONNECTING A CABLE

Direct Connection

Connect the **Spectrum Analyzer RF In 50 Ω** port of the JD740A series and the PA output port of BTS.

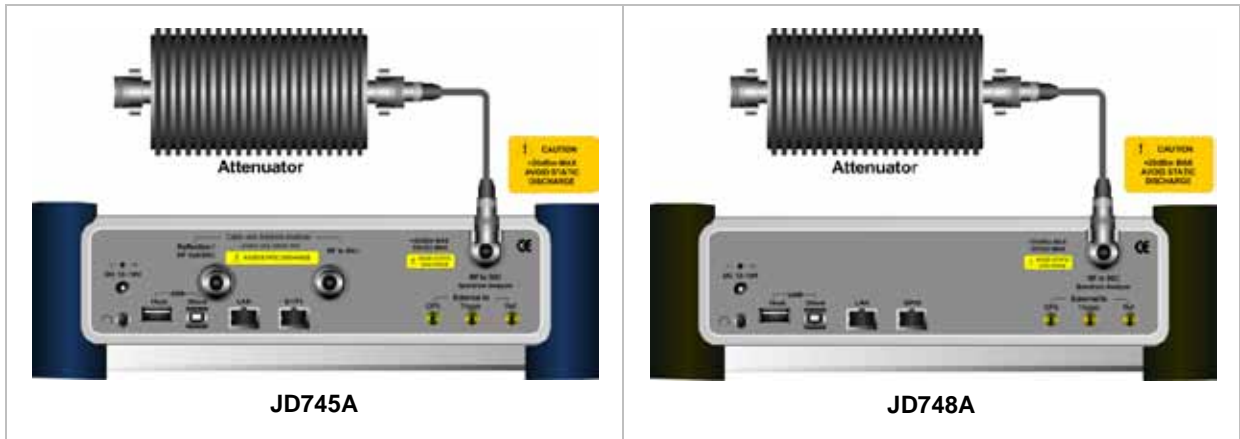

Indirect Connection

Connect the **Spectrum Analyzer RF In 50 Ω** port of the JD740A series and the monitor port of BTS.

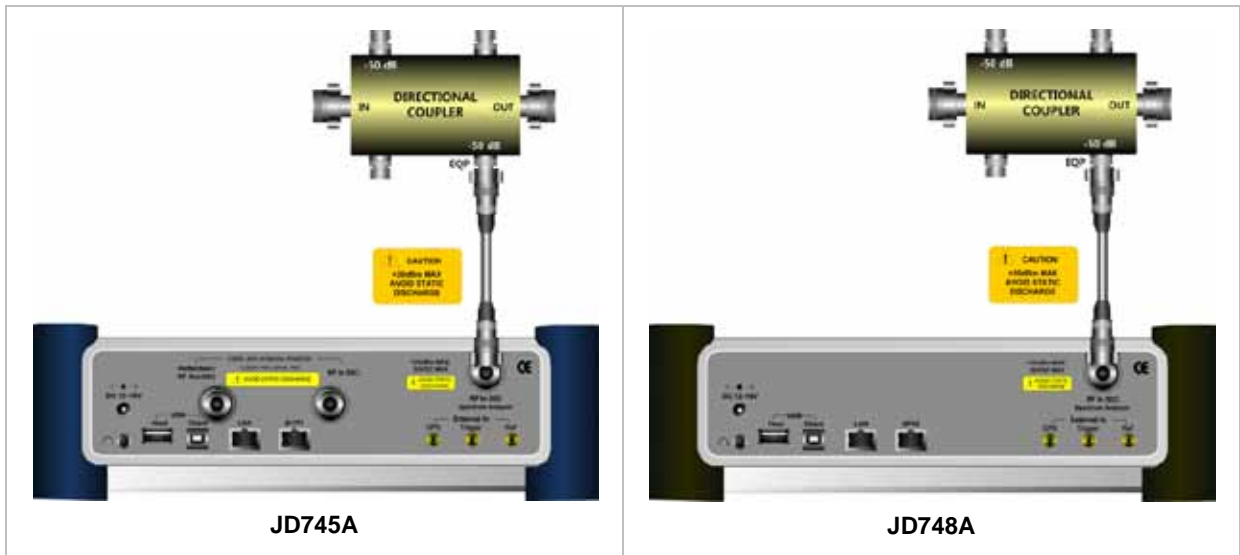

The maximum power for the **Spectrum Analyzer RF In 50 Ω** port is +20 dBm (0.1 Watt). If the input signal level to be measured is greater than +20 dBm, use a **High Power Attenuator** to prevent damage when you directly connect the signal to the instrument. Or connect the signal from the coupling port of a directional coupler.

SPECTRUM ANALYSIS MEASUREMENTS

Setting Mode

| Step | Description |
|---|--|
| 1. Connect the cable | Connect a cable directly or indirectly as shown in the section Connecting a Cable on page 5 of this chapter. |
| 2. Select the mode MODE [Spectrum Analyzer] | Press the MODE hard key. Press the Spectrum Analyzer soft key. |

Setting Frequency

| Step | Description |
|--|---|
| 1. Set the frequency FREQ/DIST [Unit] <Freq> or <Channel> | Press the FREQ/DIST hard key. Press the Unit soft key. Toggle this key between Freq and Channel . A set of Freq/Dist screen menu changes accordingly. |
| <u>When Freq is selected:</u> [Center Frequency] Enter a value [GHz], [MHz], [kHz], or [Hz] | Press the Center Frequency soft key. Use the rotary knob or the arrow keys. Or use the numeric keys to input value and then press one of the unit soft keys to complete the input. |
| [Span] [Span], [Full Span], [Zero Span], or [Last Span] Enter a value [GHz], [MHz], [kHz], or [Hz] | Press the Span soft key in the Freq/Dist menu bar. Press one of the soft keys to select. When the Span is selected, use the rotary knob or the arrow keys to change value. Or use the numeric keys to input value and then press one of the unit soft keys to complete the input. |
| or | |
| [Start Frequency] Enter a value [GHz], [MHz], [kHz], or [Hz] | Press the Start Frequency soft key. Use the rotary knob or the arrow keys. Or use the numeric keys to input value and then press one of the unit soft keys to complete the input. |
| [Stop Frequency] Enter a value [GHz], [MHz], [kHz], or [Hz] | Press the Stop Frequency soft key. Use the rotary knob or the arrow keys. Or use the numeric keys to input value and then press one of the unit soft keys to complete the input. |
| <u>When Channel is selected:</u> [Channel Standard] Select a band | Press the Channel Standard soft key. Select a band to be measured by using the rotary knob, the arrow keys, or Page Up/Page Down soft keys. Press the |

| | |
|--|--|
| <p>[Channel Number] Enter a value [Enter] or ENTER</p> <p>[Span] [Span], [Full Span], [Zero Span], or [Last Span] Enter a value [GHz], [MHz], [kHz], or [Hz]</p> <p>[Link] <FWD> or <REV></p> | <p>Select soft key to confirm the selection. Press the Channel Number soft key. Use the numeric keys to input value and press the Enter soft key or ENTER hard key to complete the input. The instrument automatically displays its corresponding center frequency value for the channel number.</p> <p>Press the Span soft key in the Freq/Dist menu bar. Press one of the soft keys to select. When the Span is selected, use the rotary knob or the arrow keys to change value. Or use the numeric keys to input value and then press one of the unit soft keys to complete the input.</p> <p>Press the Link soft key to set the link direction. Toggle this key between FWD and REV.</p> |
|--|--|

FREQ/DIST



There are three ways to set the frequency band: center frequency/span, start frequency/stop frequency, and channel number/span.

- n **UNIT:** Determines the way how to set the frequency band either with standard band or custom frequency band. Toggling this key between **Freq** and **Channel** changes a set of Freq/Dist screen menu automatically.

When the unit is set to Frequency:

- n **CENTER FREQUENCY:** Changes the center frequency setting in the spectrum measurement. Use the rotary knob or the arrow keys. Or use the numeric keys to input a certain value and press one of the unit soft keys to complete the input.
- n **SPAN:** Sets the frequency range over which the instrument will sweep.
- n **START FREQUENCY:** Changes the start frequency in the spectrum measurement. Use the rotary knob or the arrow keys. Or use the numeric keys to input a certain value and press one of the unit soft keys to complete the input.
- n **STOP FREQUENCY:** Changes the stop frequency in the spectrum measurement. Use the rotary knob or the arrow keys. Or use the numeric keys to input a certain value and press one of the unit soft keys to complete the input.
- n **FREQUENCY STEP:** Defines the amount of frequency to be increased or decreased when using the rotary knob or the arrow keys to change the **Center Frequency**, **Start Frequency**, or **Stop Frequency**. This frequency step size can be entered by using numeric keys and the unit soft keys.

When the unit is set to Channel:

- n **CHANNEL NUMBER:** Enters a channel number. The instrument automatically displays its corresponding center frequency value for the channel number.
- n **SPAN:** Sets the frequency range over which the instrument will sweep.
- n **CHANNEL STEP:** Defines the amount of channel to be increased or decreased when using the rotary knob or the arrow keys to change the **Channel Number**. This channel step size can be entered by using numeric keys and the **Enter** soft key.
- n **LINK:** Sets the direction of sweeping. Toggle this key between **FWD** and **REV**.
- n **CHANNEL STANDARD:** When the channel standard is selected from the list, the center frequency information on the display screen will be mapped accordingly to the selected channel standard. The channel standards available in the instrument are listed in the Appendix C – Band, Frequency & Channel Standard.

Setting Amplitude

| Step | Description |
|--|---|
| 1. Set the reference/attenuation level AMP/SCALE [Auto Scale] or [Reference Level] Enter a reference level value [dBm] or ENTER [Attenuation] <Manual> Enter an attenuation value | Press the AMP/SCALE hard key. Press the Auto Scale soft key to automatically set optimum levels of reference and attenuation. Press the Reference Level soft key to set manually. Use the numeric keys or the rotary knob that changes in a 10 dB step. Press the dBm soft key or the ENTER hard key. Press the Attenuation soft key. The Auto mode is set by default. This key toggles between the Auto and Manual . Press the Attenuation soft key to highlight the Manual mode and change the attenuation value to optimize S/N. Use the numeric keys or the rotary knob that changes in a 5 dB step. The attenuation setting range is 0 to 50 dB. |



- n **AUTO SCALE:** The instrument can automatically set the scale to the minimum and maximum values on the Y-axis of the graph for optimum display of the traces measured. This can be done by adjusting attenuation and reference level automatically. Each time the **Auto Scale** is selected, the top and bottom scales are set to the minimum and maximum values with margin on the Y-axis

of the display screen.

- n **REFERENCE LEVEL:** Sets the maximum Y-axis range.
- n **SCALE/DIV:** Is used only for the Spectrum measurement screen. It represents the value of one division on the horizontal scale. The default value is 10 dB per division and the maximum value is set up to 20 dB. Selecting the **Scale/Div** soft key enables to set the value to 1 dB per division with the numeric keys or the rotary knob.
- n **ATTENUATION**
 - Y **AUTO:** Input attenuator's value is automatically set depending on the reference level. This is the default operation mode, so it is recommended to use this mode unless a special measurement condition is needed.
 - Y **MANUAL:** Sets the attenuator's value for the **Spectrum Analyzer RF In 50 Ω** port.
- n **PREAMP:** Turns on or off the internal pre-amplifier. Preamp results in a correction being applied to compensate for the gain of the preamp so that amplitude readings show the value at the input connector. This soft key toggles between **On** and **Off**. When it is set to On, the allowable attenuation input range is from 0 dB to 10 dB in a multiple of 5. If the attenuation value is manually set greater than 10 dB, the instrument will automatically turn off the pre-amplifier to display low level signal properly on the screen.
- n **UNITS:** Sets the scale unit on the display among **dBm**, **dBV**, **dBmV**, **dBuV**, **V**, and **W**.
- n **EXTERNAL OFFSET:** Sets an external offset value. An offset consists of a cable loss and a user offset and the measurement result shows the value reflecting both offset values. When the external offset value is set at 40 dB in the Spectrum mode, the measurement result compensates 40 dB at both the Spectrum Analyzer and Signal Analyzer modes.

Setting Bandwidth

| Step | Description |
|--|--|
| 1. Set the bandwidth BW/AVG [RBW] Enter RBW value [MHz], [kHz], or [Hz] [VBW] Enter VBW value [MHz] or [kHz] or [Hz] [VBW/RBW] <1>, <0.3>, <0.1>, <0.03> | Press the BW/AVG hard key. Press the RBW soft key. Use the numeric keys and the unit soft keys or the rotary knob. Press the VBW soft key. Use the numeric keys and the unit soft keys or the rotary knob. Press the VBW/RBW soft key. Each time the key is pressed the selection changes in sequence from 1 to |

| | |
|--------------------|--------|
| <0.01>, or <0.003> | 0.003. |
|--------------------|--------|

BW/AVG 

- n **RBW:** Sets the Resolution Bandwidth (RBW) of the Spectrum Analyzer. Toggles between the **Auto** and **Manual**. When the **Auto** is selected, the RBW is selected based on the frequency span. When the **Manual** is selected, the RBW can be set from 1 Hz to 3 MHz in a 1-3 sequence using the numeric keys, the arrow keys, or the rotary knob.
- n **VBW:** Sets the Video Bandwidth (VBW) of the Spectrum Analyzer. Toggles between the **Auto** and **Manual**. When the **Auto** is selected, the VBW is selected based on the current RBW and RBW/VBW settings.
- n **VBW/RBW:** Sets proportional VBW based on the designated RBW. Every time the VBW/RBW soft key is pressed the ratio selection changes. For the user's better understanding of the rather complicated formula, the following table shows the VBW setting in proportion to the VBW/RBW ratio at 30 kHz RBW setting as an example.

| RBW | VBW/RBW Ratio | VBW |
|--------|---------------|--------|
| 30 kHz | 1:1 | 30 kHz |
| | 1:0.3 | 10 kHz |
| | 1:0.1 | 3 kHz |
| | 1:0.03 | 1 kHz |
| | 1:0.01 | 300 Hz |
| | 1:0.003 | 100 Hz |

Setting Averaging

BW/AVG 

- n **AVERAGE:** Sets the number of measurements to be averaged for the trace presentation. A maximum of 100 times of averaging can be set.

| Step | Description |
|---|---|
| 1. Set the averaging BW/AVG [Average] | Press the BW/AVG hard key. Press the Average soft key. |
| 2. Enter number of averaging to set | Use the numeric keys and input a number between 1 and 100. |

| | |
|-----------------------------------|---|
| | When the averaging reaches to the number set here, a new measurement value replaces the earliest measurement value in sequence. |
| 3. [Enter] or ENTER | Press the Enter soft key or the ENTER hard key. |

Setting Sweep



This hot key is used to set and control the sweep parameters such as Sweep Time, Sweep Mode, Gated Sweep Settings and Gated Sweep On/Off. The user input window must be inactive first to get the Sweep hot key function other than the number input.

- n **SWEEP TIME:** Sets the sweep time automatically or manually by toggling this soft key between **Auto** and **Manual**. Use the numeric keys to input value manually and press one of the unit soft keys among **Sec**, **mSec**, and **uSec** to complete the input.
- n **SWEEP MODE:** Sets the sweep mode.

| Step | Description |
|--|--|
| 1. Set the sweep mode SWEEP [Sweep Mode] <Continue> or <Single> | Press the SWEEP hot key. Press the Sweep Mode soft key. Toggle this key between Continue and Single . |

- n **GATED SWEEP SETTINGS:** Sets the gated sweep parameters with internal trigger source. Pressing the Gated Sweep Settings automatically changes the measurement display from frequency domain to time domain.

| Step | Description |
|---|--|
| 1. Set the gated sweep parameters SWEEP [Gated Sweep Settings] [Period] <StdSignal> or <Manual> Enter a value [Sec] , [mSec] , or [uSec] [StdSignal] [GSM (4.615 ms)] | Press the SWEEP hot key. Press the Gated Sweep Settings soft key. Press the Period soft key to select a standard signal or period manually. Toggle this key between StdSignal and Manual . Use the numeric keys to input value of period manually. Press one of the unit soft keys to select. Press the StdSignal to select a standard signal for the period. This soft key is activated when the StdSignal is |

| | |
|---|--|
| <p>[WCDMA (10 ms)], [LTE (10 ms)], [EV-DO (5 ms)], [TD-SCDMA (5 ms)], or [WiMAX (10 ms)]</p> | <p>selected for the Period setting above. Select one of the signal soft keys to choose.</p> |
| <p>2. Set the trigger TRIGGER [Video] or [Display Position] PREV</p> | <p>Press the TRIGGER hot key after setting the Period. Press the Video or Display Position soft key to set the trigger type. Press the PREV hard key in order to go back to the Gated Sweep Settings menu.</p> |
| <p>3. Continue setting the gated sweep parameters [Zero Span Time] Enter a value [Sec], [mSec], or [uSec] [Gate Delay] Enter a value [Sec], [mSec], or [uSec] [Gate Length] Enter a value [Sec], [mSec], or [uSec] PREV</p> | <p>Press the Zero Span Time soft key to set sweep time. Use the numeric keys to input value of sweep time. Press one of the unit soft keys to select. Press the Gate Delay soft key and then turn the rotary knob to change the gate delay gradually. Or use the numeric keys to input value of gate delay and then press one of the unit soft keys to complete the input. Press the Gate Length soft key and then turn the rotary knob to change the gate length gradually. Or use the numeric keys to input value of gate length and then press one of the unit soft keys to complete the input. Press the PREV hard key in order to go back to the Sweep menu and to start gated sweeping.</p> |

- Y **ZERO SPAN TIME:** Sets the zero span sweep time manually.
- Y **GATE DELAY:** Sets the gated sweep delay.
- Y **GATE LENGTH:** Sets the gated sweep length.
- Y **PERIOD:** Sets the period by selecting a standard signal from available choices or by manually entering a value.
- Y **STDSIGNAL:** Sets the type of standard signal used for the **Period** among **GSM (4.615 ms)**, **WCDMA (10 ms)**, **LTE (10 ms)**, **EV-DO (5 ms)**, **TD-SCDMA (5 ms)**, and **WiMAX (10 ms)**. This soft key is activated when the **Period** setting is set to the **StdSignal**.
- n **GATED SWEEP:** Enables or disables gated sweep. Toggle this soft key between **On** and **Off**.

Setting Trigger



TRIGGER

This hot key is used to select the trigger type among **Free Run**, **External**, **GPS**, **Video** and **Display Position**. The user input window must be inactive first to get the Trigger hot key function other than the number input. This key is activated only when the **Span** in frequency setting is set to **Zero Span**.

Setting Trace and Display



TRACE/DISPLAY

- n **SELECT TRACE:** Selects an active trace from T1 to T6. Trace numbers are assigned to each captured trace or loaded trace. Pressing one of the 6 trace number soft keys sets the selected trace number as the active trace on the display screen.
- n **CLEAR WRITE:** Clears the selected trace and writes or assigns the current trace.
- n **MAX HOLD:** Sets the active trace to display the maximum response of the input signal. Active trace compares newly acquired data with the trace shown on the screen and displays the bigger trace on the display screen.
- n **MIN HOLD:** Sets the active trace to display the minimum response of the input signal. Active trace compares newly acquired data with the trace shown on the screen and displays the smaller trace on the display screen.
- n **CAPTURE:** Captures a current trace on the display screen with the selected trace number.
- n **TRACE VIEW:** Displays the trace of the selected trace number on the display screen or hides it from the display screen. Press the **Select Trace** soft key to select a trace number and then press the **Trace View** soft key to toggle between the **Off** to hide and **On** to restore a hidden trace.
- n **TRACE CLEAR ALL:** Deletes all traces from the instrument and initializes the trace settings.
- n **DETECTORS:** Selects a detection method of how the measurements in each data point are displayed on the X-axis. There are 5 detection methods available in the spectrum measurements.
 - Y **NORMAL:** Displays random noise better than the Peak does without missing signals.
 - Y **PEAK:** Displays the highest value of the measurements in each data point.
 - Y **RMS:** Displays the Root Mean Squared (RMS) average power of the measurements across the spectrum.
 - Y **NEGATIVE PEAK:** Displays lowest value of the measurements in each data point.
 - Y **SAMPLE:** Displays the center value of the measurements in each data point.

Setting RF Source

The JD740A series provides RF Source function as a CW signal generator with different power levels.

| Step | Description |
|--|---|
| 1. Set the RF source parameters MEASURE SETUP [RF Source] [RF Source] <On> or <Off> [Frequency] Enter a value [GHz], [MHz], [kHz], or [Hz] [Power Level] Enter a value [dBm] or ENTER | Press the MEASURE SETUP hot key. Press the RF Source soft key. Press the RF Source soft key in the RF Source menu bar. Toggle this soft key between On and Off . Press the Frequency soft key. Use the numeric keys to input value. Press one of the unit soft keys to select. Press the Power Level soft key. Use the numeric keys to input 0 or a value between -80 and -30 to set the power level. Press the unit soft key or the ENTER hard key. |

MEASURE SETUP



- n **RF SOURCE:** Sets the frequency and power level of RF Source.
- Y **RF SOURCE:** Turns RF Source function on or off by toggling this soft key between **On** and **Off**.
- Y **FREQUENCY:** Sets the frequency of RF Source.
- Y **POWER LEVEL:** Sets the power level. Use the numeric keys to input 0 or a value between -80 and -30 and press the unit soft key or the **ENTER** hard key.

Setting Event Save

The JD740A series provides Event Save function that allows the user to automatically save measurement screen or trace in case the measurement result is **Fail**. If the result is Pass, this function will not be executed.

| Step | Description |
|--|---|
| 1. Set the event save parameters MEASURE SETUP [Event Save] [Event Save] | Press the MEASURE SETUP hot key. Press the Event Save soft key. Press the Event Save soft key in the Event Save menu |

| | |
|------------------------------------|--|
| <On> or <Off> | bar. Toggle this soft key between On and Off |
| [Save Type] <Screen> or <Trace> | Press the Save Type soft key. Toggle this soft key between Screen and Trace . |
| [Save Then Stop] <On> or <Off> | Press the Save Then Stop soft key. Toggle this soft key between On and Off . |
| [Location] <Internal> or <USB> | Press the Location soft key to set where to save. Toggle this soft key between Internal and USB . |

MEASURE SETUP



- n **EVENT SAVE:** Sets the event save parameters.
 - Y **EVENT SAVE:** Turns Event Save function on or off by toggling this soft key between **On** and **Off**. When this is set to On, the screen keyboard pops up for the user to set a file name.
 - Y **SAVE TYPE:** Sets what to save: measurement screen or trace.
 - Y **SAVE THEN STOP:** Turns Save Then Stop function on or off by toggling this soft key between **On** and **Off**. Setting this on saves once, while off continually saves measurements those meet criteria for saving.
 - Y **LOCATION:** Sets where to save: the instrument's internal memory or an external USB memory device.

Setting Limit

LIMIT



This hot key is used to set the threshold value for the display on the display screen. It turns on or off the display line or multi-segment line of the measurement. The user input window must be inactive first to get the Limit hot key function other than the number input.

| Step | Description |
|--|---|
| 1. Set the limit LIMIT [Display Line] <On> or <Off> Enter a value [dBm] or ENTER | Press the LIMIT hot key. Press the Display Line soft key to toggle between On and Off and select one. Use the numeric keys to input limit value. Press the unit soft key or the ENTER hard key. |

| | |
|---|---|
| <p>[Multi Segment Line] [Auto Set]</p> | <p>Press the Multi Segment Line soft key. Press the Auto Set soft key to set the segment line limit automatically.</p> |
| <p>Or</p> | |
| <p>[Multi Segment Line] [Limit] <Upper> or <Lower></p> | <p>Press the Limit soft key to set the pass/fail criteria upper or lower segment limit. Toggle this key between Upper and Lower.</p> |
| <p>[Limit] <On> or <Off></p> | <p>Press the Limit soft key to enable or disable the upper or lower segment line on the display screen.</p> |
| <p>[# of Line] Enter a value [Enter] or [ENTER]</p> | <p>Press the # of Line soft key to set segment line numbers to use. Use the numeric keys to input value between 1 and 25. Press the Enter soft key or the ENTER hard key.</p> |
| <p>[Edit Limit] [Line] <On> or <Off> [Frequency/Distance] Enter a value [GHz], [MHz], [kHz], or [Hz] [Amplitude] Enter a value [dBm] or [ENTER]</p> | <p>Press the Edit Limit soft key to edit segment line(s) properties. Press the Line soft key to draw a line or not. Toggle this key between On and Off. Press the Frequency/Distance soft key. Use the numeric keys to input value. Press one of the unit soft keys to complete the input. Press the Amplitude soft key. Use the numeric keys to input value. Press the unit soft key or the ENTER hard key.</p> |
| <p>[Add Point]</p> | <p>Press the Add Point soft key to add a point on the right-hand side of the active point.</p> |
| <p>[Delete Point]</p> | <p>Press the Delete Point soft key to delete the active point.</p> |
| <p>[Move Point Left]</p> | <p>Press the Move Point Left soft key to select a point next to the left as an active point.</p> |
| <p>[Move Point Right]</p> | <p>Press the Move Point Right soft key to select a point next to the right as an active point.</p> |
| <p>[Move Limit] [Limit Up/Down] Enter a value [dB] or [ENTER] [Limit Left/Right]</p> | <p>Press the Move Limit soft key. Press the Limit Up/Down soft key to move the multi-segment line upward or downward. Use the numeric keys to input value. Press the dB unit soft key or the ENTER hard key. Press the Limit Left/Right soft key to move the multi-</p> |

| | |
|--|---|
| Enter a value [GHz], [MHz], [kHz], or [Hz] | segment line to the left or to the right. Use the numeric keys to input value. Press one of the unit soft keys. |
| [Save/Recall] | Press the Save/Recall soft key to save the current setting as a file or to retrieve an existing setting. |

- n **DISPLAY LINE:** Enables or disables the display line on the screen that activates an adjustable horizontal line that is used as a visual reference line. Toggle the **Display Line** soft key to select it to **On** or **Off**. Use the numeric keys to set the line value.
- n **MULTI SEGMENT LINE:** Sets multi-segment line(s).
 - Y **AUTO SET:** Sets the segment line limit automatically.
 - Y **LIMIT:** Sets the pass/fail criteria upper or lower segment limit. Toggle this key between **Upper** and **Lower**.
 - Y **LIMIT:** Enables or disables the upper or lower segment line on the display screen. Toggle this key between **On** and **Off**.
 - Y **# OF LINE:** Sets segment line numbers to be used. Use the numeric keys to input value between 1 and 25 and then press the **Enter** soft key or the **ENTER** hard key.
 - Y **EDIT LIMIT:** Edits segment line(s) properties.
 - **LINE:** Shows or hides a segment line. Toggle this key between **On** and **Off**.
 - **FREQUENCY/DISTANCE:** Sets the frequency of the segment line. Use the numeric keys to input value and then press one of the unit soft keys to complete the input.
 - **AMPLITUDE:** Sets the amplitude of the segment line. Use the numeric keys to input value and then press the unit soft key or the **ENTER** hard key.
 - **ADD POINT:** Adds a point on the right-hand side of the active point.
 - **DELETE POINT:** Deletes the active point.
 - **MOVE POINT LEFT:** Selects a point next to the left as an active point.
 - **MOVE POINT RIGHT:** Selects a point next to the right as an active point.
 - Y **MOVE LIMIT:** Moves the segment line limit.
 - **LIMIT UP/DOWN:** Moves the multi-segment line upward or downward. Use the numeric keys to input value and then press the **dB** unit soft key or the **ENTER** hard key.
 - **LIMIT LEFT/RIGHT:** Moves the multi-segment line to the left or to the right. Use the numeric keys to input value and then press one of the unit soft keys.
 - Y **SAVE/RECALL:** Saves the current setting as a file or retrieves an existing setting.

Measurement Example

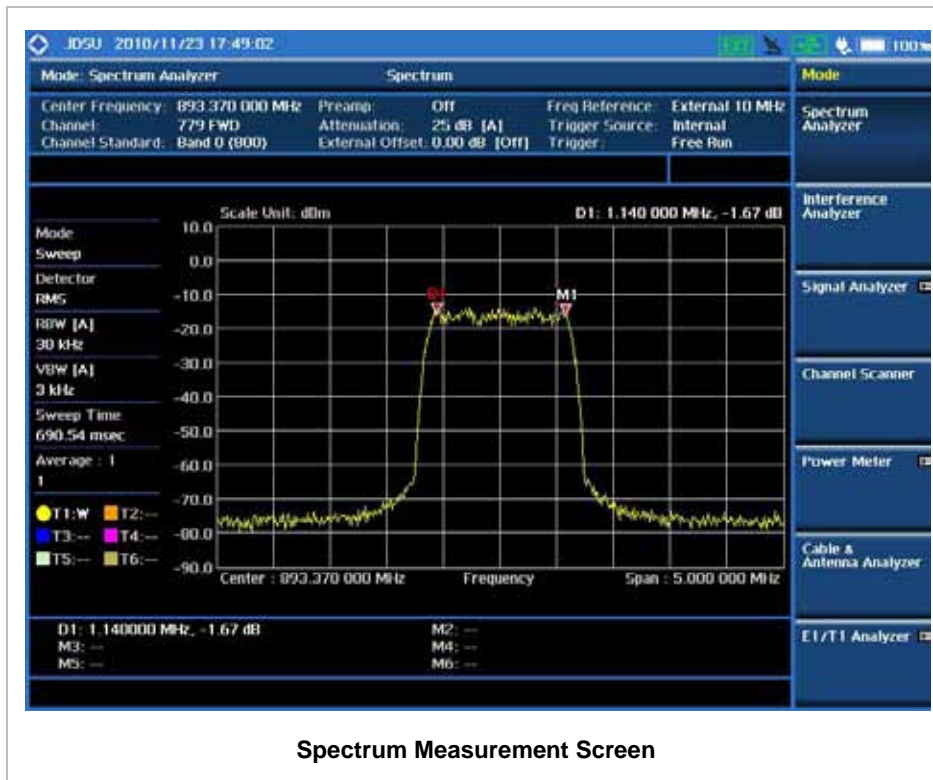

RF ANALYSIS MEASUREMENTS

RF Analysis in the Spectrum Analyzer mode provides single-button measurements for the following measurements.

- n Channel Power
- n Occupied Bandwidth
- n Spectrum Emission Mask
- n Adjacent Channel Power (ACP)
- n Spurious Emissions
- n AM/FM Audio Demodulation
- n Field Strength
- n Route Map

Setting Mode

| Step | Description |
|---|--|
| 1. Connect the cable | Connect a cable directly or indirectly as shown in the section Connecting a Cable on page 5 of this chapter. |
| 2. Select the measurement mode MODE [Spectrum Analyzer] MEASURE [Channel Power], [Occupied BW], [Spectrum Emission Mask], [Adjacent Channel Power], [Spurious Emissions], [AM/FM Audio Demod], [Field Strength Meter] | Press the MODE hard key. Press the Spectrum Analyzer soft key. Press the MEASURE hot key. Press one of the measurement mode soft keys to select. |

Setting Frequency

This setting is not used in the Spurious Emissions mode.

| Step | Description |
|---|---|
| 1. Set the frequency FREQ/DIST [Unit] <Freq> or <Channel> <i>When Freq is selected:</i> [Center Frequency] Enter a value [GHz], [MHz], [kHz], or [Hz] [Span] [Span], [Full Span], [Zero Span], or [Last Span] Enter a value [GHz], [MHz], [kHz], or [Hz] or [Start Frequency] | Press the FREQ/DIST hard key. Press the Unit soft key. Toggle this key between Freq and Channel . A set of Freq/Dist screen menu changes accordingly. Press the Center Frequency soft key. Use the rotary knob or the arrow keys. Or use the numeric keys to input value and then press one of the unit soft keys to complete the input. Press the Span soft key in the Freq/Dist menu bar. Press one of the soft keys to select. When the Span is selected, use the rotary knob or the arrow keys to change value. Or use the numeric keys to input value and then press one of the unit soft keys to complete the input. Press the Start Frequency soft key. |

| | |
|--|--|
| <p>Enter a value [GHz], [MHz], [kHz], or [Hz]</p> <p>[Stop Frequency] Enter a value [GHz], [MHz], [kHz], or [Hz]</p> <p><i>When Channel is selected:</i> [Channel Standard] Select a band</p> <p>[Channel Number] Enter a value [Enter] or ENTER</p> <p>[Span] [Span], [Full Span], [Zero Span], or [Last Span] Enter a value [GHz], [MHz], [kHz], or [Hz]</p> <p>[Link] <FWD> or <REV></p> | <p>Use the rotary knob or the arrow keys. Or use the numeric keys to input value and then press one of the unit soft keys to complete the input.</p> <p>Press the Stop Frequency soft key.</p> <p>Use the rotary knob or the arrow keys. Or use the numeric keys to input value and then press one of the unit soft keys to complete the input.</p> <p>Press the Channel Standard soft key.</p> <p>Select a band to be measured by using the rotary knob, the arrow keys, or Page Up/Page Down soft keys. Press the Select soft key to confirm the selection.</p> <p>Press the Channel Number soft key.</p> <p>Use the numeric keys to input value and press the Enter soft key or ENTER hard key to complete the input. The instrument automatically displays its corresponding center frequency value for the channel number.</p> <p>Press the Span soft key in the Freq/Dist menu bar.</p> <p>Press one of the soft keys to select. When the Span is selected, use the rotary knob or the arrow keys to change value. Or use the numeric keys to input value and then press one of the unit soft keys to complete the input.</p> <p>Press the Link soft key to set the link direction. Toggle this key between FWD and REV.</p> |
|--|--|

FREQ/DIST 

There are three ways to set the frequency band: center frequency/span, start frequency/stop frequency, and channel number/span.

- n **UNIT:** Determines the way how to set the frequency band either with standard band or custom frequency band. Toggling this key between **Freq** and **Channel** changes a set of Freq/Dist screen menu automatically.

When the unit is set to Frequency:

- n **CENTER FREQUENCY:** Changes the center frequency setting in the spectrum measurement. Use the rotary knob or the arrow keys. Or use the numeric keys to input a certain value and press one of the unit soft keys to complete the input.
- n **SPAN:** Sets the frequency range over which the instrument will sweep.
- n **START FREQUENCY:** Changes the start frequency in the spectrum measurement. Use the rotary

knob or the arrow keys. Or use the numeric keys to input a certain value and press one of the unit soft keys to complete the input.

- n **STOP FREQUENCY:** Changes the stop frequency in the spectrum measurement. Use the rotary knob or the arrow keys. Or use the numeric keys to input a certain value and press one of the unit soft keys to complete the input.
- n **FREQUENCY STEP:** Defines the amount of frequency to be increased or decreased when using the rotary knob or the arrow keys to change the **Center Frequency**, **Start Frequency**, or **Stop Frequency**. This frequency step size can be entered by using numeric keys and the unit soft keys.

When the unit is set to Channel:

- n **CHANNEL NUMBER:** Enters a channel number. The instrument automatically displays its corresponding center frequency value for the channel number.
- n **SPAN:** Sets the frequency range over which the instrument will sweep.
- n **CHANNEL STEP:** Defines the amount of channel to be increased or decreased when using the rotary knob or the arrow keys to change the **Channel Number**. This channel step size can be entered by using numeric keys and the **Enter** soft key.
- n **LINK:** Sets the direction of sweeping. Toggle this key between **FWD** and **REV**.
- n **CHANNEL STANDARD:** When the channel standard is selected from the list, the center frequency information on the display screen will be mapped accordingly to the selected channel standard. The channel standards available in the instrument are listed in the Appendix C – Band, Frequency & Channel Standard.

Setting Amplitude

| Step | Description |
|---|--|
| 1. Set the reference/attenuation level AMP/SCALE [Auto Scale] or [Reference Level] Enter a reference level value [dBm] or ENTER | Press the AMP/SCALE hard key. Press the Auto Scale soft key to automatically set optimum levels of reference and attenuation. Press the Reference Level soft key to set manually. Use the numeric keys or the rotary knob that changes in a 10 dB step. Press the dBm soft key or the ENTER hard key. |

| | |
|----------------------------|---|
| [Attenuation] | Press the Attenuation soft key. The Auto mode is set by default. This key toggles between the Auto and Manual . |
| <Manual> | Press the Attenuation soft key to highlight the Manual mode and change the attenuation value to optimize S/N. |
| Enter an attenuation value | Use the numeric keys or the rotary knob that changes in a 5 dB step. The attenuation setting range is 0 to 50 dB. |

AMP/SCALE



- n **AUTO SCALE:** The instrument can automatically set the scale to the minimum and maximum values on the Y-axis of the graph for optimum display of the traces measured. This can be done by adjusting attenuation and reference level automatically. Each time the **Auto Scale** is selected, the top and bottom scales are set to the minimum and maximum values with margin on the Y-axis of the display screen.
- n **REFERENCE LEVEL:** Sets the maximum Y-axis range.
- n **SCALE/DIV:** Is used only for the Spectrum measurement screen. It represents the value of one division on the horizontal scale. The default value is 10 dB per division and the maximum value is set up to 20 dB. Selecting the **Scale/Div** soft key enables to set the value to 1 dB per division with the numeric keys or the rotary knob.
- n **ATTENUATION**
 - Y **AUTO:** Input attenuator's value is automatically set depending on the reference level. This is the default operation mode, so it is recommended to use this mode unless a special measurement condition is needed.
 - Y **MANUAL:** Sets the attenuator's value for the **Spectrum Analyzer RF In 50 Ω** port.
- n **PREAMP:** Turns on or off the internal pre-amplifier. Preamp results in a correction being applied to compensate for the gain of the preamp so that amplitude readings show the value at the input connector. This soft key toggles between the **On** and **Off**. When it is set to On, the allowable attenuation input range is from 0 dB to 10 dB in a multiple of 5. If the attenuation value is manually set greater than 10 dB, the instrument will automatically turn off the pre-amplifier to display low level signal properly on the screen.
- n **UNITS:** Sets the scale unit on the display among **dBm**, **dBV**, **dBmV**, **dBuV**, **V**, and **W**. Scale units available for the Field Strength mode are **dBuV/m**, **dBmV/m**, **dBV/m**, **Volt/m**, **Watt/m²**, and **dBm/m²**.
- n **EXTERNAL OFFSET:** Sets an external offset value. An offset consists of a cable loss and a user offset and the measurement result shows the value reflecting both offset values. When the external offset value is set at 40 dB in the Spectrum mode, the measurement result compensates 40 dB at both the Spectrum Analyzer and Signal Analyzer modes. *This setting is not used in the Field Strength mode.*

Setting Bandwidth

This setting is not used in the Spurious Emissions mode.

| Step | Description |
|---|---|
| 1. Set the bandwidth BW/AVG [RBW] Enter RBW value [MHz], [kHz], or [Hz] [VBW] Enter VBW value [MHz] or [kHz] or [Hz] [VBW/RBW] <1>, <0.3>, <0.1>, <0.03> , <0.01>, or <0.003> | Press the BW/AVG hard key. Press the RBW soft key. Use the numeric keys and the unit soft keys or the rotary knob. Press the VBW soft key. Use the numeric keys and the unit soft keys or the rotary knob. Press the VBW/RBW soft key. Each time the key is pressed the selection changes in sequence from 1 to 0.003. |



BW/AVG

- n **RBW:** Sets the Resolution Bandwidth (RBW) of the Spectrum Analyzer. Toggles between the **Auto** and **Manual**. When the **Auto** is selected, the RBW is selected based on the frequency span. When the **Manual** is selected, the RBW can be set from 1 Hz to 3 MHz in a 1-3 sequence using the numeric keys, the arrow keys, or the rotary knob.
- n **VBW:** Sets the Video Bandwidth (VBW) of the Spectrum Analyzer. Toggles between the **Auto** and **Manual**. When the **Auto** is selected, the VBW is selected based on the current RBW and RBW/VBW settings.
- n **VBW/RBW:** Sets proportional VBW based on the designated RBW. Every time the VBW/RBW soft key is pressed the ratio selection changes. For the user's better understanding of the rather complicated formula, the following table shows the VBW setting in proportion to the VBW/RBW ratio at 30 kHz RBW setting as an example.

| RBW | VBW/RBW Ratio | VBW |
|--------|---------------|--------|
| 30 kHz | 1:1 | 30 kHz |
| | 1:0.3 | 10 kHz |
| | 1:0.1 | 3 kHz |
| | 1:0.03 | 1 kHz |
| | 1:0.01 | 300 Hz |
| | 1:0.003 | 100 Hz |

Setting Averaging

BW/AVG



- n **AVERAGE:** Sets the number of measurements to be averaged for the trace presentation. A maximum of 100 times of averaging can be set.

| Step | Description |
|---|---|
| 1. Set the averaging BW/AVG [Average] | Press the BW/AVG hard key. Press the Average soft key. |
| 2. Enter number of averaging to set | Use the numeric keys and input a number between 1 and 100. When the averaging reaches to the number set here, a new measurement value replaces the earliest measurement value in sequence. |
| 3. [Enter] or ENTER | Press the Enter soft key or the ENTER hard key. |

Setting Sweep

SWEEP



This hot key is used to set and control the sweep parameters such as Sweep Time, Sweep Mode, Gated Sweep Settings and Gated Sweep On/Off. The user input window must be inactive first to get the Sweep hot key function other than the number input.

- n **SWEEP TIME:** Sets the sweep time automatically or manually by toggling this soft key between **Auto** and **Manual**. Use the numeric keys to input value manually and press one of the unit soft keys among **Sec**, **mSec**, and **uSec** to complete the input. *This setting is not used in the Spurious Emissions mode.*
- n **SWEEP MODE:** Sets the sweep mode. *This setting is not used in the Field Strength mode, the AM/FM Audio Demodulation mode, and the Route Map mode.*

| Step | Description |
|--|--|
| 1. Set the sweep mode SWEEP [Sweep Mode] <Continue> or <Single> | Press the SWEEP hot key. Press the Sweep Mode soft key. Toggle this key between Continue and Single . |

- n **GATED SWEEP SETTINGS:** Sets the gated sweep parameters with internal trigger source. Pressing the Gated Sweep Settings automatically changes the measurement display from

frequency domain to time domain. *This setting is not used in the Spurious Emissions mode, the Field Strength mode, and the Route Map mode.*

| Step | Description |
|--|--|
| <p>1. Set the gated sweep parameters</p> <p>SWEEP</p> <p>[Gated Sweep Settings]</p> <p>[Period]</p> <p><StdSignal> or <Manual></p> <p>Enter a value</p> <p>[Sec], [mSec], or [uSec]</p> <p>[StdSignal]</p> <p>[GSM (4.615 ms)],</p> <p>[WCDMA (10 ms)],</p> <p>[LTE (10 ms)],</p> <p>[EV-DO (5 ms)],</p> <p>[TD-SCDMA (5 ms)], or</p> <p>[WiMAX (10 ms)]</p> | <p>Press the SWEEP hot key.</p> <p>Press the Gated Sweep Settings soft key.</p> <p>Press the Period soft key to select a standard signal or period manually. Toggle this key between StdSignal and Manual.</p> <p>Use the numeric keys to input value of period manually.</p> <p>Press one of the unit soft keys to select.</p> <p>Press the StdSignal to select a standard signal for the period. This soft key is activated when the StdSignal is selected for the Period setting above. Select one of the signal soft keys to choose.</p> |
| <p>2. Set the trigger</p> <p>TRIGGER</p> <p>[Video] or [Display Position]</p> <p>PREV</p> | <p>Press the TRIGGER hot key after setting the Period.</p> <p>Press the Video or Display Position soft key to set the trigger type.</p> <p>Press the PREV hard key in order to go back to the Gated Sweep Settings menu.</p> |
| <p>3. Continue the gated sweep parameters</p> <p>[Zero Span Time]</p> <p>Enter a value</p> <p>[Sec], [mSec], or [uSec]</p> <p>[Gate Delay]</p> <p>Enter a value</p> <p>[Sec], [mSec], or [uSec]</p> <p>[Gate Length]</p> <p>Enter a value</p> <p>[Sec], [mSec], or [uSec]</p> <p>PREV</p> | <p>Press the Zero Span Time soft key.</p> <p>Use the numeric keys to input value of sweep time.</p> <p>Press one of the unit soft keys to select.</p> <p>Press the Gate Delay soft key and then turn the rotary knob to change the gate delay gradually.</p> <p>Or use the numeric keys to input value of gate delay and then press one of the unit soft keys to complete the input.</p> <p>Press the Gate Length soft key and then turn the rotary knob to change the gate length gradually.</p> <p>Or use the numeric keys to input value of gate length and then press one of the unit soft keys to complete the input.</p> <p>Press the PREV hard key in order to go back to the</p> |

| | |
|--|---|
| | Sweep menu and to start gated sweeping. |
|--|---|

- Y **ZERO SPAN TIME:** Sets the zero span sweep time manually.
- Y **GATE DELAY:** Sets the gated sweep delay.
- Y **GATE LENGTH:** Sets the gated sweep length.
- Y **PERIOD:** Sets the period by selecting a standard signal from available choices or by manually entering a value.
- Y **STDSIGNAL:** Sets the type of standard signal used for the **Period** among **GSM (4.615 ms)**, **WCDMA (10 ms)**, **LTE (10 ms)**, **EV-DO (5 ms)**, **TD-SCDMA (5 ms)**, and **WiMAX (10 ms)**.
This soft key is activated when the **Period** setting is set to the **StdSignal**.
- n **GATED SWEEP:** Enables or disables gated sweep. *This setting is not used in the Spurious Emissions mode and the Field Strength mode.*

Setting Trace and Display

TRACE/DISPLAY

- n **SELECT TRACE:** Selects an active trace from T1 to T6. Trace numbers are assigned to each captured trace or loaded trace. Pressing one of the 6 trace number soft keys sets the selected trace number as the active trace on the display screen.
- n **CLEAR WRITE:** Clears the selected trace and writes or assigns the current trace.
- n **MAX HOLD:** Sets the active trace to display the maximum response of the input signal. Active trace compares newly acquired data with the trace shown on the screen and displays the bigger trace on the display screen.
- n **MIN HOLD:** Sets the active trace to display the minimum response of the input signal. Active trace compares newly acquired data with the trace shown on the screen and displays the smaller trace on the display screen.
- n **CAPTURE:** Captures a current trace on the display screen with the selected trace number.
- n **TRACE VIEW:** Displays the trace of the selected trace number on the display screen or hides it from the display screen. Press the **Select Trace** soft key to select a trace number and then press the **Trace View** soft key to toggle between the **Off** to hide and **On** to restore a hidden trace.
- n **TRACE CLEAR ALL:** Deletes all traces from the instrument and initializes the trace settings.
- n **DETECTORS:** Selects a detection method of how the measurements in each data point are displayed on the X-axis. There are 5 detection methods available in the spectrum measurements.

- Y **NORMAL:** Displays random noise better than the Peak does without missing signals.
- Y **PEAK:** Displays the highest value of the measurements in each data point.
- Y **RMS:** Displays the Root Mean Squared (RMS) average power of the measurements across the spectrum.
- Y **NEGATIVE PEAK:** Displays lowest value of the measurements in each data point.
- Y **SAMPLE:** Displays the center value of the measurements in each data point.

Setting RF Source

The JD740A series provides RF Source functionality as a CW signal generator with 7 different power levels.

| Step | Description |
|--|---|
| 1. Set the RF source parameters MEASURE SETUP [RF Source] [RF Source] <On> or <Off> [Frequency] Enter a value [GHz], [MHz], [kHz], or [Hz] [Power Level] Enter a value [dBm] or ENTER | Press the <i>MEASURE SETUP</i> hot key. Press the RF Source soft key. Press the RF Source soft key in the RF Source menu bar. Toggle this soft key between On and Off. Press the Frequency soft key. Use the numeric keys to input value. Press one of the unit soft keys to select. Press the Power Level soft key. Use the numeric keys to input 0 or a value between -80 and -30 to set the power level. Press the unit soft key or the ENTER hard key. |

MEASURE SETUP



- n **RF SOURCE:** Sets the frequency and power level of RF Source.
- Y **RF SOURCE:** Turns RF Source function on or off by toggling this soft key between **On** and **Off**.
- Y **FREQUENCY:** Sets the frequency of RF Source.
- Y **POWER LEVEL:** Sets the power level. Use the numeric keys to input 0 or a value between -80 and -30 and press the unit soft key or the **ENTER** hard key.

Setting Event Save

The JD740A series provides Event Save function that allows the user to automatically save measurement screen or trace in case the measurement result is **Fail**. If the result is Pass, this function will not be executed.

| Step | Description |
|--|---|
| 1. Set the event save parameters MEASURE SETUP [Event Save] [Event Save] <On> or <Off> [Save Type] <Screen> or <Trace> [Save Then Stop] <On> or <Off> [Location] <Internal> or <USB> | Press the MEASURE SETUP hot key. Press the Event Save soft key. Press the Event Save soft key in the Event Save menu bar. Toggle this soft key between On and Off . Press the Save Type soft key. Toggle this soft key between Screen and Trace . Press the Save Then Stop soft key. Toggle this soft key between On and Off . Press the Location soft key to set where to save. Toggle this soft key between Internal and USB . |

MEASURE SETUP 

- n **EVENT SAVE:** Sets the event save parameters.
- Y **EVENT SAVE:** Turns Event Save function on or off by toggling this soft key between **On** and **Off**. When this is set to On, the screen keyboard pops up for the user to set a file name.
- Y **SAVE TYPE:** Sets what to save: measurement screen or trace.
- Y **SAVE THEN STOP:** Turns Save Then Stop function on or off by toggling this soft key between **On** and **Off**. Setting this on saves once, while off continually saves measurements those meet criteria for saving.
- Y **LOCATION:** Sets where to save: the instrument's internal memory or an external USB memory device.

.....

CHANNEL POWER

Measurement Procedure

| Step | Description |
|---|---|
| 1. Select the measurement mode MEASURE [Channel Power] | Press the MEASURE hot key. Press the Channel Power soft key. |
| 2. Set the measurement parameters MEASURE SETUP [Integrated BW] Enter a value [GHz], [MHz], [kHz], or [Hz] [Span] Enter a value [GHz], [MHz], [kHz], or [Hz] [Test Limit] [High Limit] Enter a value [dBm] [Low Limit] Enter a value [dBm] [Average] Enter a value [Enter] or ENTER [Test Limit] <On> or <Off> | Press the MEASURE SETUP hot key. Press the Integrated BW soft key. Use the numeric keys to enter bandwidth to be measured. Press the unit soft key to select. Press the Span soft key. Use the numeric keys to enter span frequency. Press the unit soft key to select. Press the Test Limit soft key. Press the High Limit soft key. Use the rotary knob or the arrow keys to change the value or use the numeric keys to enter a value. Press the dBm soft key to complete the input. Press the Low Limit soft key. Use the rotary knob or the arrow keys to change the value or use the numeric keys to enter a value. Press the dBm soft key to complete the input. Press the Average soft key. Use the numeric keys to enter a value. Press the Enter soft key or the ENTER hard key. Press the Test Limit soft key to show or hide the displaying of Pass/Fail result on the screen. Toggle between the On and Off . |

MEASURE SETUP



Sets the measurement parameters including integration bandwidth and test limit. The measurement settings can be saved and recalled as a file. Also, JDViewer, PC application software allows the user to set the parameters in the user’s computer to import into the instrument.

- n **INTEGRATED BW:** Sets the channel power measurement bandwidth to be measured. Enter a value with the numeric keys, the rotary knob, or the arrow keys. When using the numeric keys, the input is completed by selecting one of the unit soft keys.
- n **SPAN:** Sets the frequency range over which the instrument will sweep.

- n **TEST LIMIT:** Sets the high and low test limits for the Pass/Fail criteria.
- Y **HIGH LIMIT:** Sets the upper value of the limit. Use the numeric keys to input value and press the **dBm** unit soft key to complete the input.
- Y **LOW LIMIT:** Sets the low value of the limit. Use the numeric keys to input value and press the **dBm** unit soft key to complete the input.
- n **AVERAGE:** Sets the frequency the number of trace to be averaged.
- n **TEST LIMIT:** Shows or hides the displaying of Pass/Fail result on the screen. Toggle between **On** and **Off** to display the Pass/Fail result or not.
- n **EVENT SAVE:** Refer to the **Setting Event Save** section in this chapter.
- n **RF SOURCE:** Refer to the **Setting RF Source** section in this chapter.

Measurement Example

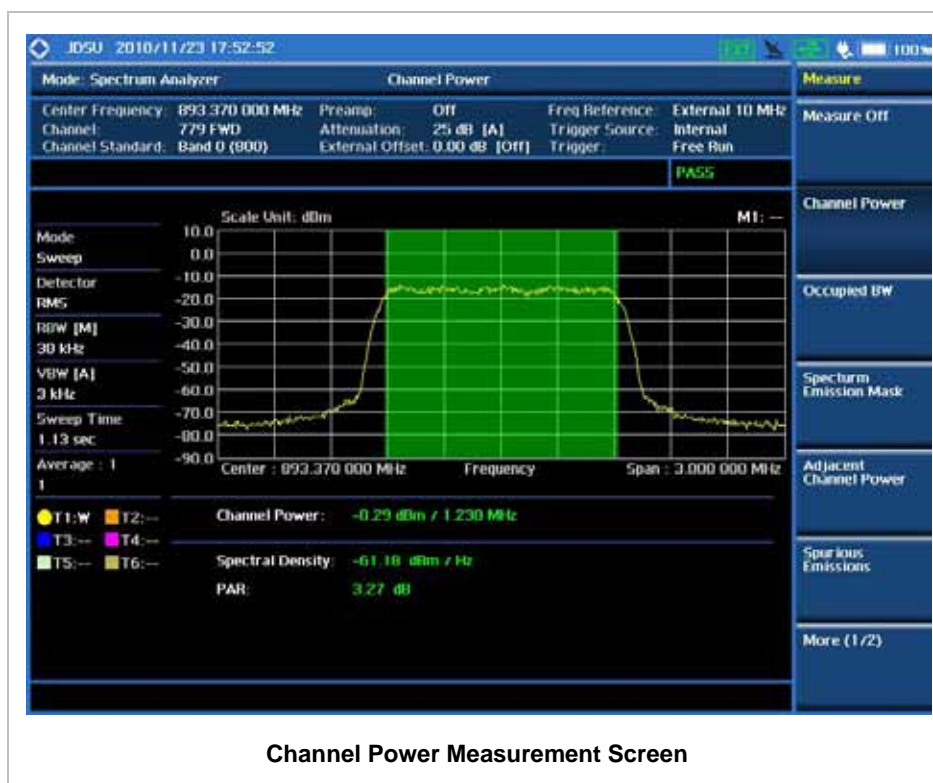

Channel power measurement result shows channel power and power spectral density in a user specified channel bandwidth. The peak to average ratio (PAR) is shown at the bottom of the screen as well. The shadow area on the display indicates the channel bandwidth.

OCCUPIED BANDWIDTH

The Occupied Bandwidth measures the percentage of the transmitted power within a specified bandwidth. The percentage is typically 99%.

Measurement Procedure

| Step | Description |
|---|---|
| 1. Select the measurement mode MEASURE [Occupied BW] | Press the MEASURE hot key. Press the Occupied BW soft key. |
| 2. Set the measurement parameters MEASURE SETUP [Occupied BW % Power] Enter a value [Enter] or ENTER [Span] Enter a value [GHz], [MHz], [kHz], or [Hz] [Test Limit] [High Limit] Enter a value [MHz], [kHz], or [Hz] [Average] Enter a value [Enter] or ENTER [Test Limit] <On> or <Off> | Press the MEASURE SETUP hot key. Press the Occupied BW % Power soft key. Use the numeric keys to enter % value to be measured. Press the Enter soft key or the ENTER hard key. Press the Span soft key. Use the numeric keys to enter span frequency. Press the unit soft key to select. Press the Test Limit soft key. Press the High Limit soft key. Use the rotary knob or the arrow keys to change the value or use the numeric keys to enter a value. Press the unit soft key to select to complete the input. Press the Average soft key. Use the numeric keys. Press the Enter soft key or the ENTER hard key. Press the Test Limit soft key to show or hide the displaying of Pass/Fail result on the screen. Toggle between the On and Off . |

MEASURE SETUP



Sets the measurement parameters including occupied bandwidth power percentage and test limit. The measurement settings can be saved and recalled as a file. Also, JDViewer, PC application software

allows the user to set the parameters in the user's computer to import into the instrument.

- n **OCCUPIED BW % POWER:** Sets the percentage of power within the bandwidth to be measured. Enter a value with the numeric keys and then press the **Enter** soft key to complete the input.
- n **SPAN:** Sets the frequency range over which the instrument will sweep.
- n **TEST LIMIT:** Sets the high test limit for the Pass/Fail criteria.
- n **AVERAGE:** Sets the frequency the number of trace to be averaged.
- n **TEST LIMIT:** Shows or hides the displaying of Pass/Fail result on the screen. Toggle between the **On** and **Off** to display the Pass/Fail result or not.
- n **EVENT SAVE:** Refer to the **Setting Event Save** section in this chapter.
- n **RF SOURCE:** Refer to the **Setting RF Source** section in this chapter.

Measurement Example

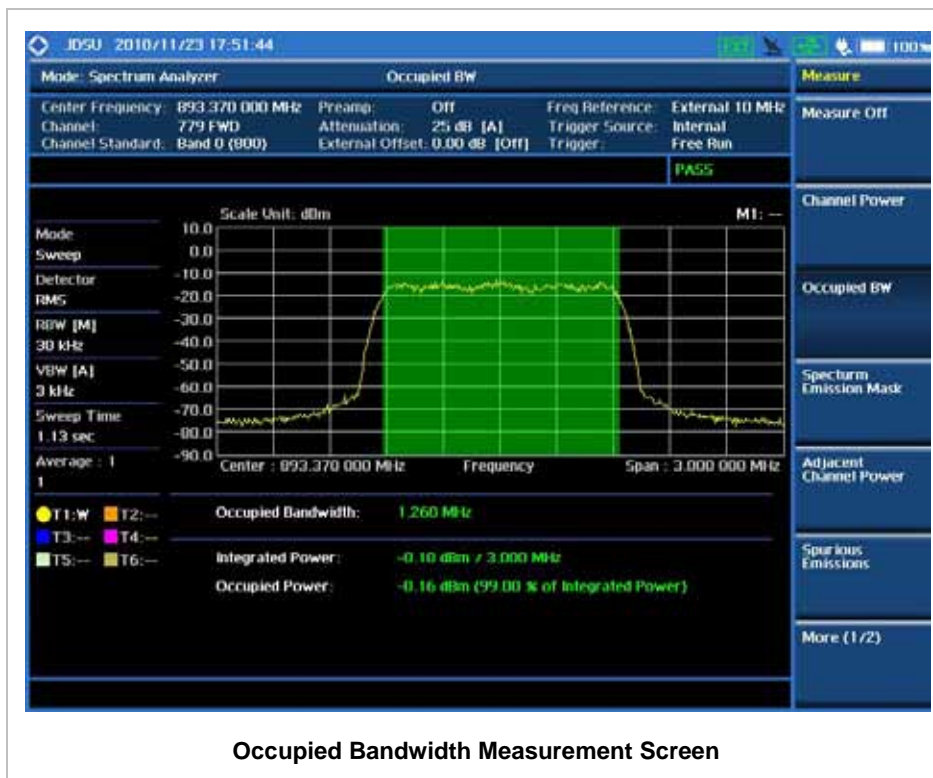

Occupied Bandwidth Measurement Screen

Occupied Bandwidth measurement shows both of power across the band and power bandwidth in a user specified percentage to determine the amount of spectrum used by a modulated signal. Occupied bandwidth is typically calculated as the bandwidth containing 99% of the transmitted power.

SPECTRUM EMISSION MASK (SEM)

The Spectrum Emission Mask (SEM) measurement is to identify and determine the power level of out-of-band spurious emission outside the necessary channel bandwidth and modulated signal. It measures the power ratio between in-band and adjacent channels. The JD740A series indicates either Pass or Fail based on the specified limit of the signal.

Measurement Procedure

| Step | Description |
|--|---|
| 1. Select the measurement mode MEASURE [Spectrum Emission Mask] | Press the MEASURE hot key. Press the Spectrum Emission Mask soft key. |
| 2. Set the measurement parameters MEASURE SETUP [Main Channel BW] Enter a value [MHz], [kHz], or [Hz] [Span] Enter a value [GHz], [MHz], [kHz], or [Hz] [Offset/Limit] [Offset] Select an offset number [Offset Frequency] Enter a value [MHz], [kHz], or [Hz] [Measurement Bandwidth] Enter a value [MHz], [kHz], or [Hz] [Start Offset Limit] Enter a value [dB] [Stop Offset Limit] Enter a value [dB] | Press the MEASURE SETUP hot key. Press the Main Channel BW soft key. Use the numeric keys to enter the bandwidth of the main channel to be measured. Press one of the unit soft keys to select. Press the Span soft key. Use the numeric keys to enter span frequency. Press one of the unit soft keys to select. Press the Offset/Limit soft key. Press the Offset soft key to select the offset number. Each time the Offset soft key is pressed, selection changes. Maximum 5 different offsets can be set. Press the Offset Frequency soft key. Use the numeric keys to input value. Press the unit soft key to select. Press the Measurement Bandwidth soft key. Use the numeric keys to input value. Press the unit soft key to select. Press the Start Offset Limit soft key. Use the numeric keys to input value. Press the dB unit soft key. Press the Stop Offset Limit soft key. Use the numeric keys to input value. Press the dB unit soft key. |

| | |
|---|---|
| <p>[Offset Limit Reference] <Rel> or <Abs> [Offset] <On> or <Off></p> | <p>Press the Offset Limit Reference soft key to set it to relative or absolute value. Toggle between Rel and Abs. Press the Offset soft key to show or hide the selected offset information on the screen. Toggle between On and Off to display or not.</p> |
| <p>[Average] Enter a value [Enter] or ENTER</p> | <p>Press the Average soft key. Use the numeric keys to input value. Press the Enter soft key or the ENTER hard key.</p> |
| <p>[Test Limit] <On> or <Off></p> | <p>Press the Test Limit soft key to show or hide the displaying of Pass/Fail result on the screen. Toggle between On and Off.</p> |

MEASURE SETUP



Sets the measurement parameters including main channel bandwidth, offset and test limit. The measurement settings can be saved and recalled as a file. Also, JDViewer, PC application software allows the user to set the parameters in the user's computer to import into the instrument.

- n **MAIN CHANNEL BW:** Sets the main channel bandwidth. Enter a value with the numeric keys and then press the unit soft keys to complete the input.
- n **SPAN:** Sets the frequency range over which the instrument will sweep.
- n **OFFSET/LIMIT:** Sets the adjacent channel bandwidth, offset frequency, and start and stop offset limits for any of wireless standards. A mask can be consisted of horizontal, vertical, and sloping lines.
 - Y **OFFSET:** Selects the offset number from 1 to 5. Each time the **Offset** soft key is pressed, selection changes to **1, 2, 3, 4, and 5**.
 - Y **OFFSET FREQUENCY:** Sets the offset frequency. Enter a value with the numeric keys and press the unit soft keys to complete the input. Offset frequency (band) will automatically turns on after the value set.
 - Y **MEASUREMENT BANDWIDTH:** Sets the measurement bandwidth. Enter a value with the numeric keys and press the unit soft keys to complete the input.
 - Y **START OFFSET LIMIT:** Sets the start offset limit or low limit. Enter a value with the numeric keys and press the **dB** unit soft key to complete the input.
 - Y **STOP OFFSET LIMIT:** Sets the stop offset limit or high limit. Enter a value with the numeric keys and press the **dB** unit soft key to complete the input.
 - Y **OFFSET LIMIT REFERENCE:** Sets the offset limit reference either to relative or absolute

value. Toggle between **Rel** and **Abs** to select.

- Y **OFFSET:** Shows or hides the selected offset information on the screen. Toggle between **On** and **Off** to display or not.
- n **AVERAGE:** Sets the frequency the number of trace to be averaged.
- n **TEST LIMIT:** Shows or hides the displaying of Pass/Fail result on the screen. Toggle between the **On** and **Off** to display the Pass/Fail result or not.
- n **EVENT SAVE:** Refer to the **Setting Event Save** section in this chapter.
- n **RF SOURCE:** Refer to the **Setting RF Source** section in this chapter.

Measurement Example

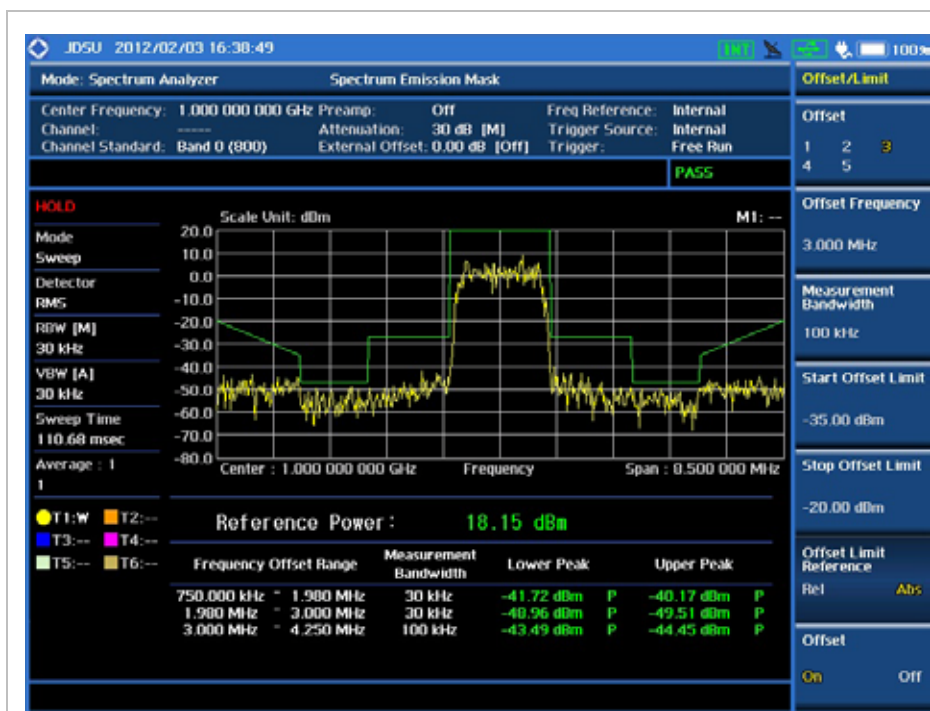

Spectrum Emission Mask Measurement Screen

This result shows PASS on the upper right corner of the display that indicates the signal is within the specified limits over specified offsets.

ADJACENT CHANNEL POWER (ACP)

The Adjacent Channel Power (ACP) is the power contained in a specified frequency channel

bandwidth relative to the total carrier power. It may also be expressed as a ratio of power spectral densities between the carrier and the specified offset frequency band.

Measurement Procedure

| Step | Description |
|--|---|
| 1. Select the measurement mode MEASURE [Adjacent Channel Power] | Press the MEASURE hot key. Press the Adjacent Channel Power soft key. |
| 2. Set the measurement parameters MEASURE SETUP [Main Channel BW] Enter a value [MHz], [kHz], or [Hz] [Span] Enter a value [GHz], [MHz], [kHz], or [Hz] [Offset/Limit] [Offset] Select a offset number [Offset Frequency] Enter a value [MHz], [kHz], or [Hz] [Integration Bandwidth] Enter a value [MHz], [kHz], or [Hz] [Negative Offset Limit] Enter a value [dB] [Positive Offset Limit] Enter a value [dB] [Offset] <On> or <Off> [Average] Enter a value [Enter] or ENTER | Press the MEASURE SETUP hot key. Press the Main Channel BW soft key. Use the numeric keys. Press the unit soft key to select. Press the Span soft key. Use the numeric keys to enter span frequency. Press the unit soft key to select. Press the Offset/Limit soft key. Press the Offset soft key to select the offset number. Each time the Offset soft key is pressed, selection changes. Press the Offset Frequency soft key. Use the numeric keys to input value. Press the unit soft key to select. Press the Integration Bandwidth soft key. Use the numeric keys to input value. Press the unit soft key to select. Press the Negative Offset Limit soft key. Use the numeric keys to input value. Press the dB unit soft key. Press the Positive Offset Limit soft key. Use the numeric keys to input value. Press the dB unit soft key. Press the Offset soft key to show or hide the selected offset information on the screen. Toggle between On and Off to display or not. Press the Average soft key. Use the numeric keys to input value. Press the Enter soft key or the ENTER hard key. |

| | |
|---|--|
| <p>[Test Limit] <On> or <Off></p> | <p>Press the Test Limit soft key to show or hide the displaying of Pass/Fail result on the screen. Toggle between On and Off.</p> |
|---|--|

MEASURE SETUP



Sets the measurement parameters including main channel bandwidth, offset and test limit. The measurement settings can be saved and recalled as a file. Also, JDViewer, PC application software allows the user to set the parameters in the user's computer to import into the instrument.

- n **MAIN CHANNEL BW:** Sets the main channel bandwidth. Enter a value with the numeric keys and then press the unit soft keys to complete the input.
- n **SPAN:** Sets the frequency range over which the instrument will sweep.
- n **OFFSET/LIMIT:** Sets the adjacent channel bandwidth, offset frequency, and positive and negative offset limits for the Pass/Fail criteria.
 - Y **OFFSET:** Selects the offset number from 1 to 5. Each time the **Offset** soft key is pressed, selection changes to **1, 2, 3, 4, and 5**.
 - Y **OFFSET FREQUENCY:** Sets the offset frequency. Enter a value with the numeric keys and press the unit soft keys to complete the input.
 - Y **INTEGRATION BANDWIDTH:** Sets the integration bandwidth. Enter a value with the numeric keys and press the unit soft keys to complete the input.
 - Y **NEGATIVE OFFSET LIMIT:** Sets the negative offset limit or low limit. Enter a value with the numeric keys and press the **dB** unit soft key to complete the input.
 - Y **POSITIVE OFFSET LIMIT:** Sets the positive offset limit or high limit. Enter a value with the numeric keys and press the **dB** unit soft key to complete the input.
 - Y **OFFSET:** Shows or hides the selected offset information on the screen. Toggle between **On** and **Off** to display or not.
- n **AVERAGE:** Sets the frequency the number of trace to be averaged.
- n **TEST LIMIT:** Shows or hides the displaying of Pass/Fail result on the screen. Toggle between the **On** and **Off** to display the Pass/Fail result or not.
- n **EVENT SAVE:** Refer to the **Setting Event Save** section in this chapter.
- n **RF SOURCE:** Refer to the **Setting RF Source** section in this chapter.

Measurement Example



Adjacent Channel Power Measurement Screen

This result shows PASS on the upper right corner of the display that indicates the signal is within the specified limits over specified offsets.

SPURIOUS EMISSIONS

The Spurious Emissions measurement is to identify or determine the power level of in-band or out-of-band spurious emissions within the necessary channel bandwidth and modulated signal. The JD740A series indicates either Pass or Fail based on the specified limit of the signal.

Measurement Procedure

| Step | Description |
|---|---|
| 1. Select the measurement mode MEASURE [Spurious Emissions] | Press the MEASURE hot key. Press the Spurious Emissions soft key. |
| 2. Set the measurement parameters MEASURE SETUP [Range Table] [Range] | Press the MEASURE SETUP hot key. Press the Range Table soft key. Press the Range soft key. |

| | |
|--|--|
| Enter a value [Enter] [Start Frequency] Enter a value [GHz], [MHz], [kHz], or [Hz] [Stop Frequency] Enter a value [GHz], [MHz], [kHz], or [Hz] [Start Limit] Enter a value [dBm] [Stop Limit] Enter a value [dBm] [Attenuation] Enter a value [dB] or ENTER [RBW] Enter a value [GHz], [MHz], [kHz], or [Hz] [VBW] Enter a value [GHz], [MHz], [kHz], or [Hz] [Measure Type] <Examine> or <Full> [Average] Enter a value [Enter] or ENTER [Test Limit] <On> or <Off> | Use the numeric keys to select the range number. Press the Enter soft key. Press the Start Frequency soft key. Use the numeric keys. Press one of the unit soft keys to select. Press the Stop Frequency soft key. Use the numeric keys. Press one of the unit soft keys to select. Press the Start Limit soft key. Use the numeric keys. Press the unit soft key to complete the input. Press the Stop Limit soft key. Use the numeric keys. Press the unit soft key to complete the input. Press the Attenuation soft key. Use the numeric keys to enter input value in the multiple of 5. Press the dB unit soft key or the ENTER hard key. Press the RBW soft key. Use the numeric keys. Press one of the unit soft keys to select. Press the VBW soft key. Use the numeric keys. Press one of the unit soft keys to select. Press the Measure Type soft key to toggle between Examine and Full . Press the Average soft key. Use the numeric keys to enter a value. Press the Enter soft key or the ENTER hard key. Press the Test Limit soft key to show or hide the displaying of Pass/Fail result on the screen. Toggle between On and Off . |
|--|--|

MEASURE SETUP



Sets the measurement parameters including range table and measurement type. The measurement settings can be saved and recalled as a file. Also, JDViewer, PC application software allows the user to set the parameters in the user's computer to import into the instrument.

- n **RANGE TABLE:** Sets the range table parameters.

- Y **RANGE:** Adds a new range number or selects one of the existing range numbers to show or hide the particular frequency range in the range table at the bottom of the screen. Use the numeric keys to enter a range number and press the Enter soft key to complete the input. Each time the Range soft key is press, it toggles between On and Off.
- Y **START FREQUENCY:** Sets or changes the start frequency value to be measured for the selected range number in the Range menu. Use the numeric keys to enter a value and press one of the unit soft keys.
- Y **STOP FREQUENCY:** Sets or changes the stop frequency value to be measured for the selected range number in the Range menu. Use the numeric keys to enter a value and press one of the unit soft keys.
- Y **START LIMIT:** Sets the start value of the limit line for the displayed range.
- Y **STOP LIMIT:** Sets the stop value of the limit line for the displayed range.
- Y **ATTENUATION:** Sets the attenuation value in the multiple of 5.
- Y **RBW:** Sets the resolution bandwidth for the selected range number in the Range menu.
- Y **VBW:** Sets the video bandwidth for the selected range number in the Range menu.
- n **MEASURE TYPE:** Sets the measurement type to **Examine** or **Full**. Toggle between **Examine** and **Full**. Examine mode will show selected range only. The instrument will automatically switch and show all ranges when Full is selected.
- n **RANGE:** Selects the range number to be displayed on the screen. Use the numeric keys to select one of the existing range numbers that are configured in the Range Table menu. Pressing the Enter soft key completes the input and changes the display. This key is activated only when the **Measure Type** is set to **Examine** mode.
- n **AVERAGE:** Sets the frequency the number of trace to be averaged.
- n **TEST LIMIT:** Shows or hides the displaying of Pass/Fail result on the screen. Toggle between the **On** and **Off** to display the Pass/Fail result or not.
- n **EVENT SAVE:** Refer to the **Setting Event Save** section in this chapter.
- n **RF SOURCE:** Refer to the **Setting RF Source** section in this chapter.

Measurement Example

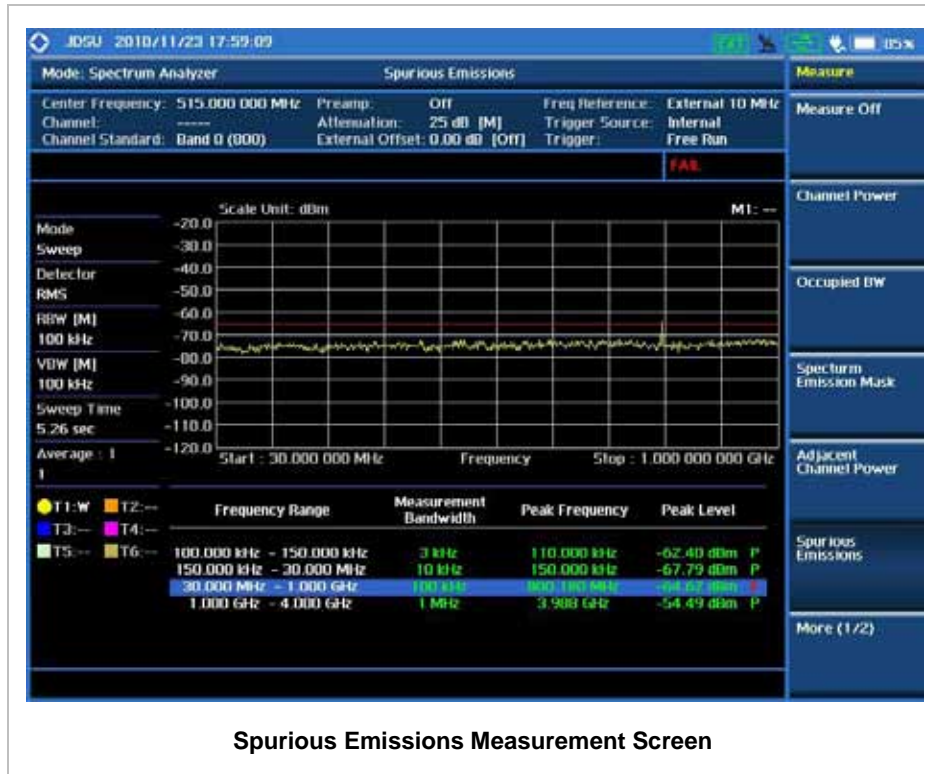

Spurious Emissions Measurement Screen

This result shows PASS on the upper right corner of the display that indicates the signal is within the specified limits.

AM/FM AUDIO DEMODULATION

The AM/FM Audio Demodulator operates using the power received from radio waves and it serves as an alternative to identify interfering signals easily. The instrument sounds demodulated signals that can be heard through the built-in speaker or plugged-in headphones. The user can hear the sound and identify interfering signals easily.

Measurement Procedure

| Step | Description |
|--|--|
| 1. Select the measurement mode MEASURE [More(1/2)] [AM/FM Audio Demod] | Press the MEASURE hot key. Press the More (1/2) soft key. Press the AM/FM Audio Demod soft key. |
| 2. Set the measurement parameters | |

| | |
|--|--|
| <p>MEASURE SETUP</p> <p>[Audio Demod] <On> or <Off></p> <p>[Demod at] [M1], [M2], [M3], [M4], [M5], or [M6]</p> <p>[Demod Mode] <AM>, <FM>, or <CW></p> <p>[Dwell Time] Enter a value [Min] or [Sec]</p> <p>[Volume] Enter a value [Enter]</p> <p>[Auto Gain] <On> or <Off></p> | <p>Press the MEASURE SETUP hot key.</p> <p>Press the Audio Demod soft key to turn it On or Off. Toggle between On and Off.</p> <p>Press the Demod at soft key.</p> <p>Press one of the marker soft keys to select the marker (M1 to M6) at the frequency to be demodulated.</p> <p>Press the Demod Mode soft key to select the mode. Toggle among AM, FM and CW.</p> <p>Press the Dwell Time soft key to set demodulation interval. Use the rotary knob and arrow keys or use the numeric keys and the unit soft key.</p> <p>Press the Volume soft key to set the speaker volume. Use the rotary knob and arrow keys or use the numeric keys and the Enter soft key.</p> <p>Press the Auto Gain soft key to turn it On or Off. Toggle between On and Off.</p> |
|--|--|

MEASURE SETUP



Sets the measurement parameters including range table and measurement type. The measurement settings can be saved and recalled as a file. Also, JDViewer, PC application software allows the user to set the parameters in the user's computer to import into the instrument.

- n **AUDIO DEMOD:** Turns the AM/FM Demodulator sound on and off.
- n **DEMOD AT:** Sets the marker at the frequency to be demodulated. The AM/FM Demodulator uses the marker position as where to demodulate. The 6 markers from **M1** to **M6** are available in different frequencies and the user can select the frequency to be demodulated among them.
- n **DEMOD MODE:** Selects **AM**, **FM** or **CW** tone to be demodulated. Every time the **Demod Mode** soft key is pressed, the selection moves.
- n **DWELL TIME:** Sets the audio demodulation time. Use the rotary knob and arrow keys to change the value. Or use the numeric keys and then press the unit soft key.
- n **VOLUME:** Sets the speaker volume. Use the rotary knob and arrow keys to adjust the volume. Or use the numeric keys and then press the **Enter** soft key.
- n **AUTO GAIN:** Turns the Auto Gain mode on and off. The Auto Gain is used to adjust internal gain of the demodulator.

Setting Limit



This hot key is used to set the threshold value for the display on the display screen. It turns on or off the display line of the measurement. The user input window must be inactive first to get the Limit hot key function other than the number input.

| Step | Description |
|---|---|
| 1. Set the limit LIMIT [Display Line] <On> or <Off> Enter a value [dBm] or ENTER | Press the LIMIT hot key. Press the Display Line soft key to toggle between On and Off and select one. Use the numeric keys to input limit value. Press the unit soft key or the ENTER hard key. |

- n **DISPLAY LINE:** Enables or disables the display line on the screen that activates an adjustable horizontal line that is used as a visual reference line. Toggle the **Display Line** soft key to select it to **On** or **Off**. Use the numeric keys to set the line value.

Measurement Example

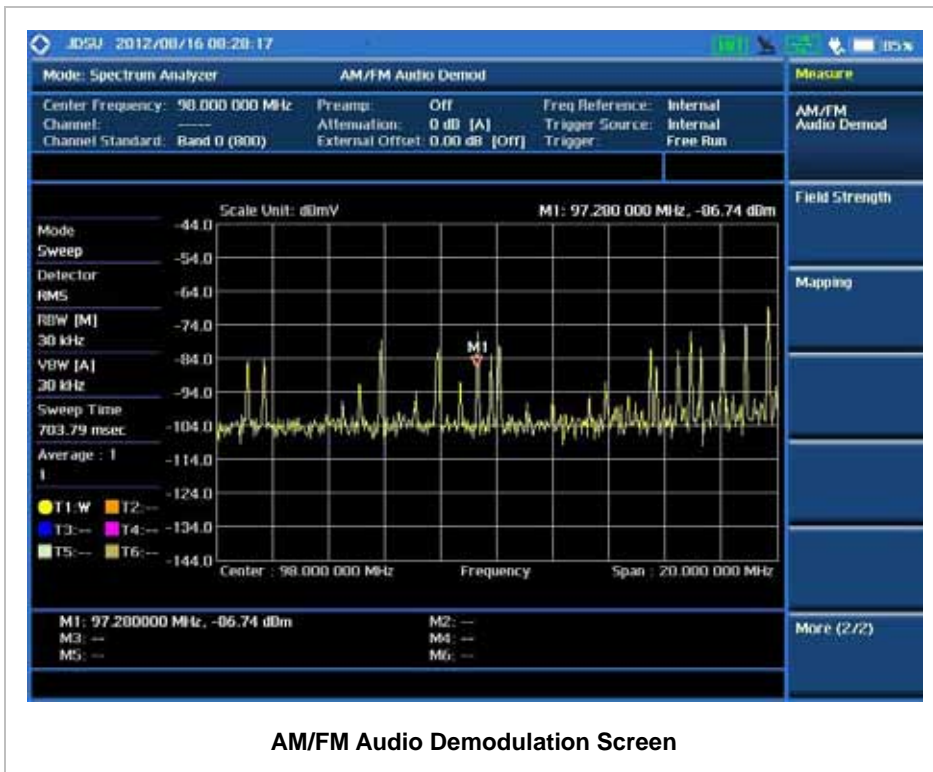

AM/FM Audio Demodulation Screen

FIELD STRENGTH METER

The Field Strength Meter measures the field strength over the frequency range of a connected antenna, which is known with its specific bandwidth and gain characteristics. A standard or user-defined antenna can be selected from the antenna list in the JD740A series.

Measurement Procedure

| Step | Description |
|--|--|
| 1. Connect the antenna | Connect an antenna to the JD740A series. |
| 2. Select the measurement mode MEASURE [More (1/2)] [Field Strength] | Press the MEASURE hot key. Press the More (1/2) soft key. Press the Field Strength soft key. |
| 3. Set the measurement parameters MEASURE SETUP [Antenna Type] Select an antenna or [Antenna Editor] [Antenna Name] [Start Frequency] Enter a value [GHz], [MHz], [kHz], or [Hz] [Stop Frequency] | Press the MEASURE SETUP hot key. Press the Antenna Type soft key to get a pop-up window with the list of standard or custom antennas. Select an antenna to be used for the field strength measurement by using the rotary knob, the arrow keys, or Page Up/Page Down soft keys. Press the Select soft key to confirm the selection. Press the Antenna Editor soft key to edit characteristics of an existing antenna or to define a new antenna and add the custom one to the pop-up antenna list. Press the Antenna Name soft key to give a name for a custom antenna to define. Use the rotary knob or the arrow keys to highlight a number or a letter and then press the Select soft key or the rotary knob to confirm each selection. Press the Done soft key to complete file naming with an extension (.ant). Press the Start Frequency soft key. Use the numeric keys to input value. Press the unit soft key to select. Press the Stop Frequency soft key. |

| | |
|--|--|
| Enter a value [GHz], [MHz], [kHz], or [Hz] [Gain] Enter a value [Enter] or ENTER [Type] [Yagi], [Omni], or [Custom] [Apply] or [Apply & Save] | Use the numeric keys to input value. Press the unit soft key to select. Press the Gain soft key. Use the numeric keys to input value in dBi. Press the Enter soft key or the ENTER hard key. Press the Type soft key to select an antenna type. Press one of the soft keys to select. Press the Apply or Apply & Save soft key to complete antenna edition. |
|--|--|

MEASURE SETUP



Sets the measurement parameters. The measurement settings can be saved and recalled as a file. Also, JDViewer, PC application software allows the user to set the parameters in the user's computer to import into the instrument.

- n **ANTENNA TYPE:** Sets an antenna to be used for field strength measurements from the pop-up list of standard antennas available in the JD740A series or custom antennas defined in the **Antenna Editor** menu. Use the rotary knob, the arrow keys, or Page Up/Page Down soft keys and then press the **Select** soft key to confirm the selection.
- n **ANTENNA EDITOR:** Edits characteristics of an existing antenna or to define a new antenna and add the custom one to the pop-up antenna list.
 - Y **APPLY:** Applies a custom antenna with its information so that it can be listed in the Antenna Type pop-up window for field strength measurements.
 - Y **APPLY & SAVE:** Applies and saves a custom antenna with its information so that it can be listed in the Antenna Type pop-up window for field strength measurements.
 - Y **ANTENNA NAME:** Selects a file name for a custom antenna to be saved in the instrument. Use the rotary knob or the arrow keys to highlight a number or a letter and then press the **Select** soft key or the rotary knob to confirm each selection. Press the **Done** soft key to complete file naming with an extension (.ant).
 - Y **START FREQUENCY:** Sets the start frequency.
 - Y **STOP FREQUENCY:** Sets the stop frequency.
 - Y **GAIN:** Sets the gain value of the antenna to be modified or added.
 - Y **TYPE:** Selects the type of the antenna to be modified or added (**Yagi**, **Omni** or **Custom**).

Setting Limit



This hot key is used to set the threshold value for the display on the display screen. It turns on or off the display line of the measurement. The user input window must be inactive first to get the Limit hot key function other than the number input.

| Step | Description |
|---|---|
| 1. Set the limit LIMIT [Display Line] <On> or <Off> Enter a value [dBm] or ENTER | Press the LIMIT hot key. Press the Display Line soft key to toggle between On and Off and select one. Use the numeric keys to input limit value. Press the unit soft key or the ENTER hard key. |

- n **DISPLAY LINE:** Enables or disables the display line on the screen that activates an adjustable horizontal line that is used as a visual reference line. Toggle the **Display Line** soft key to select it to **On** or **Off**. Use the numeric keys to set the line value.

Measurement Example

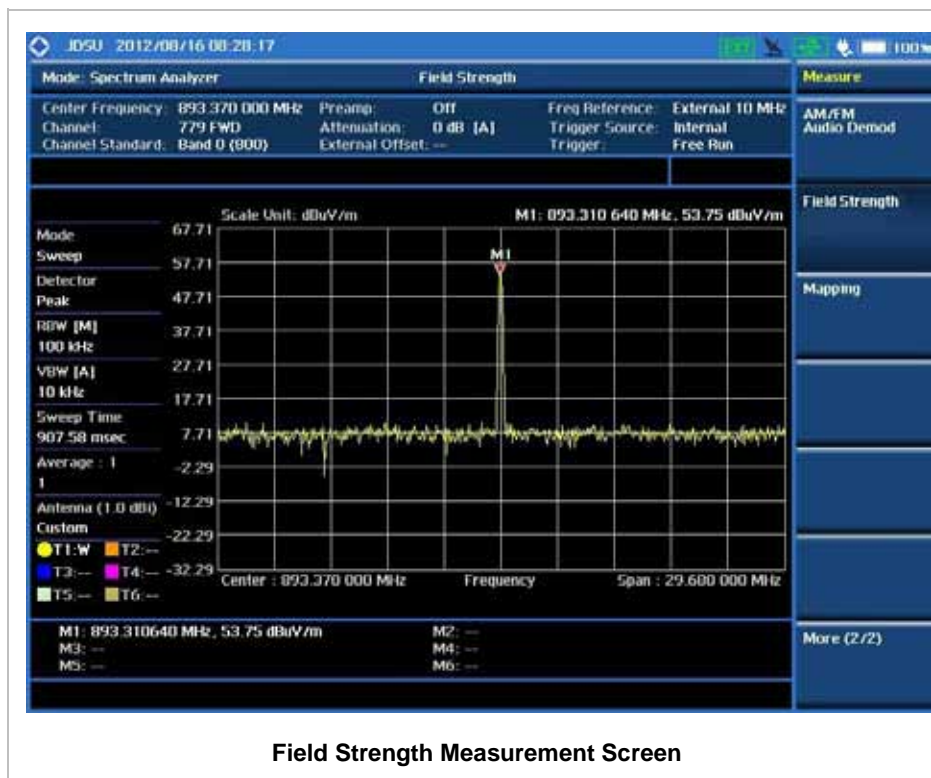

Field Strength Measurement Screen

ROUTE MAP

The JD740A Series provides indoor and outdoor mapping function that allows a user to collect data of points in an indoor or outdoor environment and track the received signals and coverage of RF transmitters plotting real time directly on top of a loaded floor plan or a map.

Measurement Procedure

| Step | Description |
|--|--|
| 1. Connect a GPS receiver | Connect a GPS receiver to the JD740A series for outdoor mapping with plot point setting as GPS. Indoor mapping does not necessarily need the GPS antenna. |
| 2. Select the measurement mode MEASURE [More (1/2)] [Route Map] | Press the MEASURE hot key. Press the More (1/2) soft key. Press the Route Map soft key. |
| 3. Set the measurement parameters MEASURE SETUP [Load Map] [Plot Point] [Time], [Position], or [GPS] [Plot Item] [RSSI] or [ACPR] [Screen Mode] <Map> or <Full> [Main Channel BW] Enter a value [MHz], [kHz], or [Hz] [Offset/Limit] [Integration Bandwidth] | Press the MEASURE SETUP hot key. After plugging in a USB drive, press the Load Map soft key to load a map file created in JMapCreator and copied into the USB drive. Press the Plot Point soft key to get option menu. Press one of the soft keys to select. When GPS is selected, the Screen Mode key becomes activated to be set. Press the Plot Item soft key. Select either RSSI or ACPR as needed. When ACPR is selected, the Main Channel BW and Offset/Limit keys become activated to be set. Press the Screen Mode soft key. Toggle this key between Map and Full . Press the Main Channel BW soft key. Use the numeric keys. Press one of the unit soft keys to select. Press the Offset/Limit soft key. Press the Integration Bandwidth soft key. |

| | |
|--|---|
| Enter a value [MHz], [kHz], or [Hz] [Offset Frequency] Enter a value [MHz], [kHz], or [Hz] [Offset Limit] Enter a value [dB] [Offset] <On> or <Off> | Use the numeric keys to input value. Press the unit soft key to select. Press the Offset Frequency soft key. Use the numeric keys to input value. Press the unit soft key to select. Press the Offset Limit soft key. Use the numeric keys to input value. Press the dB unit soft key. Press the Offset soft key to show or hide the selected offset information on the screen. Toggle this key between On and Off to display or not. |
| [Plot] <Start> or <Stop> | Press the Plot soft key to start or stop plotting. Toggle this key between Start and Stop . |

MEASURE SETUP



Sets the measurement parameters for the Route Map. The legend displayed in different colors at the bottom of the screen can be set with the **Limit** hot key.

- n **PLOT:** Starts or stops a measurement in order to plot received signals or collected data on top of a loaded map. Toggle this key between **Start** and **Stop**. The instrument does not automatically save collected data. After stopping the current route mapping, the user needs to save the result with the **Save** hot key for later use. If not, all the collected data for the route will be lost.
- n **PLOT POINT:** Selects a method of plotting points.
- Y **TIME:** Measures data without GPS as time passes in an indoor environment. After starting to plot, press the **Enter** hard key or the center of the rotary knob as moving with the instrument. Each time the user presses the key or the knob, the instrument interpolates points in between two enters on a straight dotted line. Use the arrow keys to change direction of route and the rotary knob to change distance. If the instrument has the screen with touch screen, directly touch the screen in order to collect data.
- Y **POSITION:** Measures data without GPS in an indoor environment. After starting to plot, press the **Enter** hard key or the center of the rotary knob as you move with the instrument. Each time the user presses the key or the knob, the instrument plots a point on top of the loaded map. Use the arrow keys to change direction of route and the rotary knob to change distance. If the instrument has the screen with touch screen, directly touch the screen in order to collect data.
- Y **GPS:** Automatically collects data with GPS in an outdoor environment and plots points as the user moves in a vehicle.

- n **PLOT ITEM:** Selects either **RSSI** or **ACPR**.
- n **SCREEN MODE:** Selects either **Map** or **Full**, depending on how to show collected points on the screen. Selecting GPS for the Plot Point activates this key.
 - Y **MAP:** Displays collected points only that can be seen within the boundary of the loaded map. If a point is off the map, the instrument displays an arrow indicating the direction of the current location on the map and the distance from the center to the location at the top of the screen.
 - Y **FULL:** Displays all the measured points for the route on the screen without the map.
- n **LOAD MAP:** Loads a floor plan or a map file created in **JDMapCreator**. The JDMapCreator converts and resizes any scanned floor plan or layout so that it can be loaded and fit to the instrument display.
- n **MAIN CHANNEL BW:** Sets the main channel bandwidth. Enter a value with the numeric keys and then press the unit soft keys to complete the input.
- n **OFFSET/LIMIT:** Sets the integration bandwidth, offset frequency, and offset limits for the Pass/Fail criteria.
 - Y **INTEGRATION BANDWIDTH:** Sets the integration bandwidth. Enter a value with the numeric keys and press the unit soft keys to complete the input.
 - Y **OFFSET FREQUENCY:** Sets the offset frequency. Enter a value with the numeric keys and press the unit soft keys to complete the input.
 - Y **OFFSET LIMIT:** Sets the offset threshold. Enter a value with the numeric keys and press the **dB** unit soft key to complete the input.
 - Y **OFFSET:** Shows or hides the selected offset information on the screen. Toggle between **On** and **Off** to display or not.

Setting Limit



This hot key is used to set threshold values for the legend displayed on the screen. The four different colors of the legend indicate **Excellent**, **Very Good**, **Good**, and **Poor** depending on their threshold setting. The user input window must be inactive first to get the Limit hot key function other than the number input.

| Step | Description |
|----------------------------------|---------------------------------|
| 1. Set the limit Limit | Press the LIMIT hot key. |

| | |
|---------------------------|--|
| <p>[Excellent]</p> | <p>Press the Excellent soft key to set its threshold.</p> |
| <p>Enter a value</p> | <p>Use the rotary knob or the numeric keys.</p> |
| <p>[Enter]</p> | <p>Press the Enter soft key.</p> |
| <p>[Very Good]</p> | <p>Press the Very Good soft key to set its threshold.</p> |
| <p>Enter a value</p> | <p>Use the rotary knob or the numeric keys.</p> |
| <p>[Enter]</p> | <p>Press the Enter soft key.</p> |
| <p>[Good]</p> | <p>Press the Good soft key to set its threshold.</p> |
| <p>Enter a value</p> | <p>Use the rotary knob or the numeric keys.</p> |
| <p>[Enter]</p> | <p>Press the Enter soft key.</p> |
| <p>[Poor]</p> | <p>Press the Poor soft key to set its threshold.</p> |
| <p>Enter a value</p> | <p>Use the rotary knob or the numeric keys.</p> |
| <p>[Enter]</p> | <p>Press the Enter soft key.</p> |

Measurement Example



ANALYSIS

Using Marker

MARKER



Marker is used to get the information about a specific trace. Six markers can be set on the display and each marker can be used independently. The X and Y coordinates of the trace are displayed when the marker is placed on any position of the trace. The position displaying the marker's X and Y coordinates may be slightly different for each measurement mode and refer to the description of each measurement. There are three different marker types available: Normal, Delta, and Delta pair. Marker position can be set manually by entering numeric values (frequency) when one of the marker types is selected.

- n **SELECT MARKER:** Selects an active marker whose position can be changed with the rotary knob or the arrow keys. The assigned number of the active marker is displayed in the **Select Marker** menu box and the active marker number is also displayed right next to the active marker on the trace when the **Marker View** is set to **On**.
- n **MARKER VIEW:** Displays the selected marker on the screen or hides it. When the **Marker View** is turned off and then on again in the same measurement mode, markers appear at the previous positions. If a measurement mode is changed, markers are not restored to their previous positions.
- n **NORMAL:** This Normal marker type provides the reading of a marker position on the trace along with the marker number between 1 and 6.
- n **DELTA:** This Delta marker type is associated with a Normal marker. A Normal marker must be set before a Delta marker is set. When the Delta marker is set, the position set by the Delta marker becomes the reference position of the Normal marker and the marker's X and Y values displays the difference compared with the Delta marker.
- n **DELTA PAIR:** This Delta Pair marker type is associated with a Normal marker. A Normal marker must be set before a Delta Pair marker is set. When the Delta Pair marker is set, the position set by the Delta Pair marker becomes the reference position of the Normal marker and the marker's X and Y values displays the difference compared with the Delta Pair marker. The reference position will be varied in accordance with trace change.
- n **MARKER ALL OFF:** Turns all the markers the screen off. When the Marker View is selected for those markers, the instrument displays those markers back at the previous position. If a measurement mode is changed, current settings are not restored.
- n **MARKER \rightarrow :** Sets the X coordinate of the active marker as selected.
 - Y **MARKER \rightarrow CENTER:** Sets the frequency of the active marker to the center frequency of spectrum analyzer.
 - Y **MARKER \rightarrow START:** Sets the frequency of the active marker to the start frequency of spectrum analyzer.

- Y **MARKERà STOP:** Sets the frequency of the active marker to the stop frequency of spectrum analyzer.
- n **FREQUENCY COUNT:** Enables or disables the frequency count. Toggle between On and Off.
- n **NOISE MARKER:** Enables or disables the noise marker. Toggle between On and Off.

Using Peak Search

PEAK SEARCH

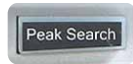

Each time the Peak Search soft key is pressed, the active marker is positioned at the highest peak of the trace.

- n **PEAK SEARCH:** Moves the active marker to the highest peak of the trace.
- n **NEXT PEAK:** Moves the active marker to the second highest peak of the trace.
- n **NEXT PEAK RIGHT:** Moves the active marker to the highest peak to the right of its current position.
- n **NEXT PEAK LEFT:** Moves the active marker to the highest peak to the left of its current position.
- n **MIN SEARCH:** Moves the active marker to the lowest peak of the trace.
- n **ALWAYS PEAK:** When the **Always Peak** is set to On, the instrument moves the active marker automatically to the highest peak of the trace every time the trace is refreshed.

Cable and Antenna Analyzer

This Cable and Antenna Analyzer function is one of the standard features that the JD740A series provides for the JD745A Base Station Analyzer and the JD746A RF Analyzer. It allows the user to test and verify feed-line, antenna, and active and passive RF components. Up to 1001 data point, high resolution and increasing maximum distance range (1500 m/4921 ft) in the DTF can be used.

The Bias Tee which is offered as the Option 013 is used to supply selectable voltage of 12 V to 32 V with 0.1 V steps on the RF In port eliminating the need of an external power supply for insertion gain/loss measurement.

In this Chapter

| | |
|---|----|
| Using Cable and Antenna Analyzer | 3 |
| Display Overview | 4 |
| Cable and Antenna Analyzer Measurements | 6 |
| Setting Mode | 6 |
| Setting Frequency | 6 |
| Setting Sweep Mode | 8 |
| Setting Trace and Display | 8 |
| Setting Limit | 9 |
| Adjusting Scale | 12 |
| Performing Calibration | 12 |
| 1 Port Calibration (Reflection, DTF, Cable Loss, 1 Port Phase, Smith Chart) | 13 |
| 2 Port Calibration (2 Port Measurements - Vector and Scalar) | 14 |
| Reflection Measurement | 17 |
| Connecting Cables for Measurement | 17 |
| Measurement Procedure | 18 |
| Changing Data Points | 19 |
| Setting Bias Tee | 19 |
| Measurement Example | 19 |
| DTF Measurement | 20 |
| Connecting Cables for Measurement | 20 |
| Measurement Procedure | 21 |
| Changing Distance | 22 |
| Changing Data Points | 22 |
| Setting Bias Tee | 23 |
| Changing DTF Setting | 23 |
| Selecting Cable | 23 |
| Measurement Example | 24 |

2 Port Measurement (Option 001) - Vector 24

 Connecting Cables for Measurement 25

 Measurement Procedure 25

 Changing Data Points 26

 Setting Bias Tee 27

 Setting Display 27

 Measurement Example 27

2 Port Measurement (Option 001) - Scalar 28

 Connecting Cables for Measurement 28

 Measurement Procedure 29

 Changing Data Points 30

 Measurement Example 30

Cable Loss (1 Port) Measurement 30

 Connecting Cables for Measurement 31

 Measurement Procedure 31

 Changing Data Points 32

 Setting Bias Tee 32

 Measurement Example 32

1 Port Phase Measurements 33

 Connecting Cables for Measurement 33

 Measurement Procedure 34

 Setting Bias Tee 35

 Measurement Example 35

Smith Chart Measurement..... 36

 Connecting Cables for Measurement 36

 Measurement Procedure 37

 Changing Data Points 38

 Setting Bias Tee 38

 Measurement Example 39

Analysis 39

 Using Marker..... 39

 Using Peak Search 40

(Rev. 6.0)

USING CABLE AND ANTENNA ANALYZER

The Cable and Antenna Analyzer of the JD740A series is a diagnostic tool needed to accurately detect operational problems. The JD745A Base Station Analyzer and the JD746A RF Analyzer of the 740 series have all of the measurement functions necessary to accurately verify antenna systems from Voltage Standing Wave Ratio (VSWR) to power measurements. In addition, the JD745A and the JD746A make distance-to-fault measurements to accurately pinpoint the faulty location.

To get maximum power into a load it is required that the load impedance match the generator impedance. Any difference in impedance or mismatching would not produce maximum power transfer. An impedance mismatch at the antenna system produces a reflective 'traveling wave' which goes in the opposite direction from the incident wave. As the two traveling waves cross each other in opposite direction, it is produce an interference pattern called a "standing wave". VSWR is the ratio between the power sent forward to the cable and/or antenna and the amount of power that is reflected back to the transmitter.

Some of the consequences of having a high VSWR condition in cellular services include dropped calls, poor reception, and an overall unacceptable performance in the cell (or section of cell) covered by the base station antenna. Therefore, the VSWR of the antenna system including the feed line is one of the most critical factors in the service and maintenance of the RF transmitter systems.

This Cable and Antenna Analyzer function performs following measurements.

- n Reflection: VSWR and Return Loss
- n Distance to Fault (DTF): VSWR and Return Loss
- n 2 Port Measurements: Vector and Scalar (Optional)
- n Cable Loss (1 Port)
- n 1 Port Phase
- n Smith Chart

DISPLAY OVERVIEW

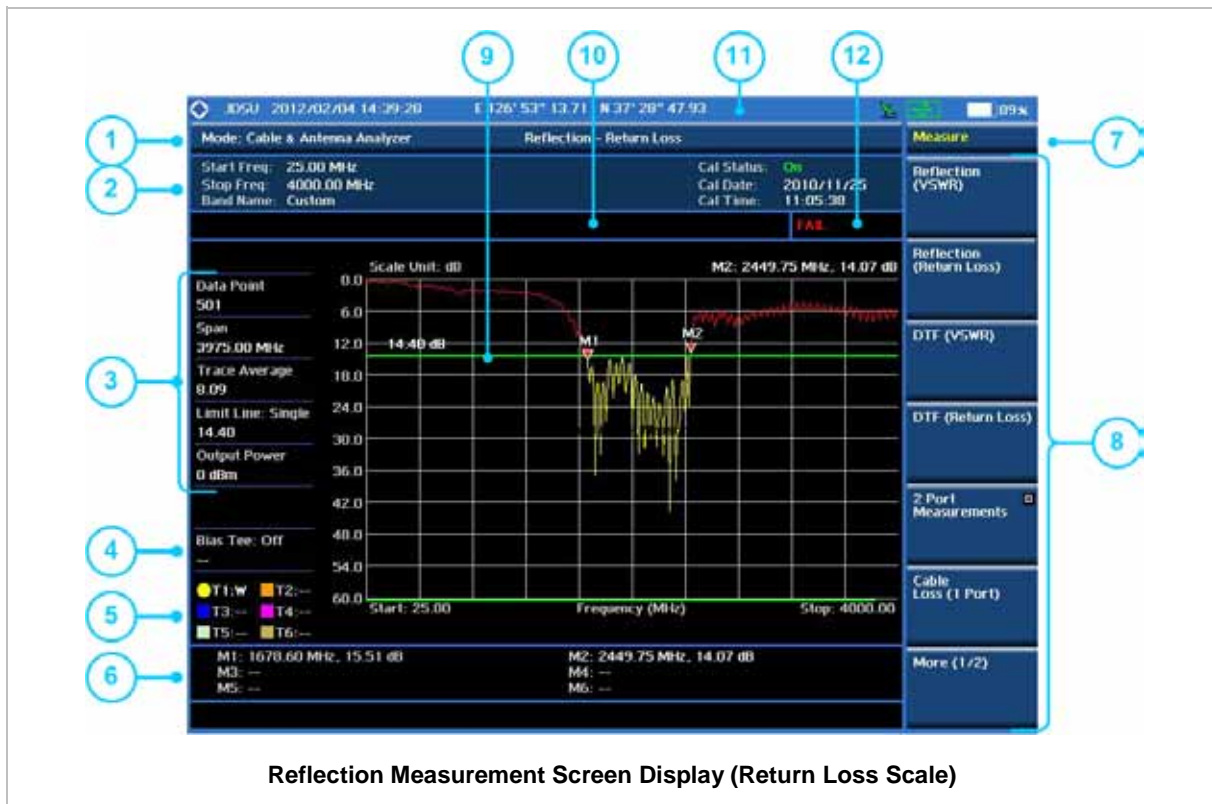

Measurement Mode Information: Cable and Antenna Analyzer

Cable and Antenna Analyzer Setting Information: This window shows the most common settings or parameters of reflection measurement such as Frequency/ Band setting and Calibration Status/Date/Time. After a calibration is successfully completed, the calibration status will display On in the green color until the setting frequency or output power level is not changed or within approximately 10 degree in temperature.

Measurement Setting Information

- Data Points is the number of data points to take during a measurement mode. The available Data Point are 126, 251, 501, and 1001, and selecting 501 data points provides twice as many measurement points as 251, but it takes approximately twice as long for the trace to sweep and display.
- Span is a user-defined frequency band. Changing the frequency band does not affect the sweep time, but affects the calibration. Recalibration is required if the frequency setting is changed.
- Trace Average indicates the average value of a single sweep over the user setting frequency band.
- Limit Line shows the limit On/Off status and the value set by the user.
- Output Power shows power level of sweep signal, 0 dBm and -30 dBm.

Bias Tee Setting Information: Voltage and current which are currently dissipating will be displayed when the bias tee is enabled.

Trace Info: Displays the trace number and trace information on the screen.

- M: Max Hold
- m: Min Hold
- C: Captured Trace
- W: Current Trace
- L: Loaded Trace
- F: Trace View Off

Information on Marker Table displays up to 6 markers

Screen Menu Title

Screen Menu and Sub-menu

Limit Line set by the user, the measurement trace beyond limit line will turn red and audible alarm goes off.

User Input Window: Activates when user input menu or key is selected. Pressing ESC hard key will cancel or deactivate user input window. Inactivate user input window before using hot keys.

NOTE: It is very important to inactivate the user input window when you intend to use the hot key menu on the numeric keys.

System Information

- Date and Time
- Positioning Information (Longitude and Latitude). It is available only when a GPS antenna is connected. Frequency reference is automatically set to GPS in the System menu when a GPS antenna is connected.
- Frequency Reference Indicator: INT for internal and EXT for external. The EXT icon is green when an external reference is locked or red when the external reference is not locked. When a GPS antenna is connected, this space will be blank.
- GPS Indicator: Color of the GPS icon changes among green, yellow and gray depending on locking status.
- USB Indicator
- DC Input Power Indicator
- Battery Indicator

Pass/Fail Indicator

CABLE AND ANTENNA ANALYZER MEASUREMENTS

Setting Mode

| Step | Description |
|---|--|
| 1. Select the mode MODE [Cable & Antenna Analyzer] [Reflection (VSWR)], [Reflection (Return Loss)], [DTF (VSWR)], [DTF (Return Loss)], [2 Port Measurements], [Cable Loss (1 Port)], [1 Port Phase], or [Smith Chart] | Press the MODE hard key. Press the Cable & Antenna Analyzer soft key. Press one of the measurement mode soft keys to select. (Reflection (VSWR) is set by default.) |

Setting Frequency

Frequencies can be set manually using the Start Frequency/Stop Frequency or Center Frequency/Span and also be selected from the band list stored in the instrument. It is desirable to set the frequency to a value that covers the normal range of the measurement with enough margins.

| Step | Description |
|---|---|
| 1. Set the frequency FREQ/DIST [Start Frequency] Enter a value [GHz], [MHz], [kHz], or [Hz] [Stop Frequency] Enter a value [GHz], [MHz], [kHz], or [Hz] or [Center Frequency] Enter a value [GHz], [MHz], [kHz], or [Hz] [Span] Enter a value [GHz], [MHz], [kHz], or [Hz] | Press the FREQ/DIST hard key. Press the Start Frequency soft key. Use the numeric keys to input value. Press one of the unit soft keys to complete the input. Press the Stop Frequency soft key. Use the numeric keys to input value. Press one of the unit soft keys to complete the input. Press the Center Frequency soft key. Use the numeric keys to input value. Press one of the unit soft keys to complete the input. Press the Span soft key. Use the numeric keys to input value. Press one of the unit soft keys to complete the input. |

| | |
|--|---|
| <p>or</p> <p>[Band List]</p> <p>[Standard Band] or</p> <p>[Custom Band]</p> | <p>Press the Band List soft key.</p> <p>Press the Standard Band or the Custom Band soft key to select a standard band.</p> |
|--|---|



Changing any frequency settings will automatically turn the calibration status to OFF on the display screen, which requires re-calibration to proceed next measurement. Always set the frequency before calibrating the instrument. Changing the trace points during the measurement does not affect the calibration.

FREQ/DIST

Sets the frequency band with either standard band or custom frequency band.

- n **START FREQUENCY:** Changes the start frequency in the measurement. Values can be entered with the numeric keys, the rotary knob, or the arrow keys. When using the numeric keys, the input is completed by selecting one of the unit soft keys including GHz, MHz, kHz, and Hz.
- n **STOP FREQUENCY:** Changes the stop frequency in the measurement. Values can be entered with the numeric keys, the rotary knob, or the arrow keys. When using the numeric keys, the input is completed by selecting one of the unit soft keys including GHz, MHz, kHz, and Hz.
- n **CENTER FREQUENCY:** Changes the center frequency setup in the measurement. Values can be entered with the numeric keys, the rotary knob, or the arrow keys. When using the numeric keys, the input is completed by selecting one of the unit soft keys including GHz, MHz, kHz, and Hz.
- n **SPAN:** Sets the frequency range over which the instrument will sweep.
- n **BAND LIST:** The Band List is a list of standard frequency bands. When a standard band is selected from the standard list or from the custom list, the information of the start frequency and stop frequency on the display screen will be changed accordingly to the selected band.
- Y **STANDARD BAND:** Is used to select a frequency band from the list of all the available bands in the instrument.

| Step | Description |
|---|--|
| <p>1. Get the band list</p> <p>FREQ/DIST</p> <p>[Band List]</p> <p>[Standard Band]</p> | <p>Press the FREQ/DIST hard key.</p> <p>Press the Band List soft key.</p> <p>Press the Standard Band soft key to get the pop-up window of the standard frequency band list.</p> |
| <p>2. Browse and highlight a signal band</p> | <p>Press the arrow keys, rotate the knob, or press the Page Up</p> |

| | |
|------------------------------------|--|
| to select | and the Page Down soft keys to highlight a frequency band to select. Pressing the Add to Custom soft key will add the highlighted band to the custom list. |
| 3. [Select] or ENTER | Press the Select soft key or the ENTER hard key. |

Y **CUSTOM BAND:** Is used to select a frequency band from the list of the user-selected standard bands.

Setting Sweep Mode

SWEEP



This hot key is used to set the sweep parameters. The user input window must be inactive first to get the Sweep hot key function other than the number input.

n **SWEEP MODE:** Sets the sweep method. Toggle between **Continue** and **Single**.

| Step | Description |
|--|---|
| 1. Set the sweep mode SWEEP [Sweep Mode] | Press the SWEEP hot key. Press the Sweep Mode soft key. Toggle between Continue and Single . |

Setting Trace and Display

This setting is not used in the Smith Chart measurement mode.

TRACE/DISPLAY



- n **SELECT TRACE:** Selects an active trace from T1 to T6. Trace numbers are assigned to each captured trace or loaded trace. Pressing one of the 6 trace number soft keys sets the selected trace number as the active trace on the display screen.
- n **CLEAR WRITE:** Clears the selected trace and writes or assigns the current trace.
- n **CAPTURE:** Captures a current trace on the display screen with the selected trace number.
- n **TRACE VIEW:** Displays the trace of the selected trace number on the display screen or hides it from the display screen. Press the **Select Trace** soft key to select a trace number and then press the **Trace View** soft key to toggle between the **Off** to hide and **On** to restore a hidden trace.
- n **TRACE CLEAR ALL:** Deletes all traces from the instrument and initializes the trace settings.

Setting Limit

LIMIT



This hot key is used to set the threshold value for the limit line on the display screen. It turns on or off the limit or band limit settings of the measurement for pass/fail indication. The user input window must be inactive first to get the Limit hot key function other than the number input. *This setting is not used in the Smith Chart measurement mode.*

| Step | Description |
|---|--|
| 1. Set the limit line LIMIT [Display Line] <On> or <Off> Enter a value [dBm] or ENTER | Press the LIMIT hot key. Press the Display Line soft key to toggle between On and Off . Use the numeric keys to input limit value. Press the unit soft key or the ENTER hard key. |
| 2. Set the band limit [Band Limit] [Band Limit 1] <On> or <Off> [Start Band] [Stop Band] and/or [Band Limit 2] <On> or <Off> [Start Band] [Stop Band] and/or [Band Limit 3] <On> or <Off> [Start Band] [Stop Band] and/or [Clear All] | Press the Band Limit soft key. Press the Band Limit 1 soft key. Toggle between On and Off . Use the numeric keys to enter a value and press the unit soft key to complete the input. Press the Band Limit 2 soft key. Toggle between On and Off . Use the numeric keys to enter a value and press the unit soft key to complete the input. Press the Band Limit 3 soft key. Toggle between On and Off . Use the numeric keys to enter a value and press the unit soft key to complete the input. Press the Clear All soft key to clear all the limit settings. |
| 3. Set the multi-segment line [Multi Segment Line] | Press the Multi Segment Line soft key. |

| | |
|--|---|
| <p>[Auto Set]</p> | <p>Press the Auto Set soft key to set the segment line limit automatically.</p> |
| <p>Or</p> | |
| <p>[Multi Segment Line] [Limit] <Upper> or <Lower></p> | <p>Press the Limit soft key to set the pass/fail criteria upper or lower segment limit. Toggle this key between Upper and Lower.</p> |
| <p>[Limit] <On> or <Off></p> | <p>Press the Limit soft key to enable or disable the upper or lower segment line on the display screen.</p> |
| <p>[# of Line] Enter a value [Enter] or [ENTER]</p> | <p>Press the # of Line soft key to set segment line numbers to use. Use the numeric keys to input value between 1 and 25. Press the Enter soft key or the ENTER hard key.</p> |
| <p>[Edit Limit] [Line] <On> or <Off> [Frequency/Distance] Enter a value [GHz], [MHz], [kHz], or [Hz] [Amplitude] Enter a value [dBm] or [ENTER] [Add Point] [Delete Point] [Move Point Left] [Move Point Right]</p> | <p>Press the Edit Limit soft key to edit segment line(s) properties. Press the Line soft key to draw a line or not. Toggle this key between On and Off. Press the Frequency/Distance soft key. Use the numeric keys to input value. Press one of the unit soft keys to complete the input. Press the Amplitude soft key. Use the numeric keys to input value. Press the unit soft key or the ENTER hard key. Press the Add Point soft key to add a point on the right-hand side of the active point. Press the Delete Point soft key to delete the active point. Press the Move Point Left soft key to select a point next to the left as an active point. Press the Move Point Right soft key to select a point next to the right as an active point.</p> |
| <p>[Move Limit] [Limit Up/Down] Enter a value [dB] or [ENTER] [Limit Left/Right] Enter a value</p> | <p>Press the Move Limit soft key. Press the Limit Up/Down soft key to move the multi-segment line upward or downward. Use the numeric keys to input value. Press the dB unit soft key or the ENTER hard key. Press the Limit Left/Right soft key to move the multi-segment line to the left or to the right. Use the numeric keys to input value.</p> |

| | |
|------------------------------|--|
| [GHz], [MHz], [kHz], or [Hz] | Press one of the unit soft keys. |
| [Save/Recall] | Press the Save/Recall soft key to save the current setting as a file or to retrieve an existing setting. |

- n **DISPLAY LINE:** Enables or disables the display line on the screen that activates an adjustable horizontal line that is used as a visual reference line. Toggle the **Display Line** soft key to select it to **On** or **Off**. Use the numeric keys to set the line value.
- n **MULTI SEGMENT LINE:** Sets multi-segment line(s).
 - Y **AUTO SET:** Sets the segment line limit automatically.
 - Y **LIMIT:** Sets the pass/fail criteria upper or lower segment limit. Toggle this key between **Upper** and **Lower**.
 - Y **LIMIT:** Enables or disables the upper or lower segment line on the display screen. Toggle this key between **On** and **Off**.
 - Y **# OF LINE:** Sets segment line numbers to be used. Use the numeric keys to input value between 1 and 25 and then press the **Enter** soft key or the **ENTER** hard key.
 - Y **EDIT LIMIT:** Edits segment line(s) properties.
 - **LINE:** Shows or hides a segment line. Toggle this key between **On** and **Off**.
 - **FREQUENCY/DISTANCE:** Sets the frequency/distance of the segment line. Use the numeric keys to input value and then press one of the unit soft keys to complete the input.
 - **AMPLITUDE:** Sets the amplitude of the segment line. Use the numeric keys to input value and then press the unit soft key or the **ENTER** hard key.
 - **ADD POINT:** Adds a point on the right-hand side of the active point.
 - **DELETE POINT:** Deletes the active point.
 - **MOVE POINT LEFT:** Selects a point next to the left as an active point.
 - **MOVE POINT RIGHT:** Selects a point next to the right as an active point.
 - Y **MOVE LIMIT:** Moves the segment line limit.
 - **LIMIT UP/DOWN:** Moves the multi-segment line upward or downward. Use the numeric keys to input value and then press the **dB** unit soft key or the **ENTER** hard key.
 - **LIMIT LEFT/RIGHT:** Moves the multi-segment line to the left or to the right. Use the numeric keys to input value and then press one of the unit soft keys.
 - Y **SAVE/RECALL:** Saves the current setting as a file or retrieves an existing setting.

Adjusting Scale

Adjusting scale does not affect the calibration state. *This setting is not used in the Smith Chart measurement mode.*

| Step | Description |
|--|--|
| 1. Set the scale AMP/SCALE [Auto Scale] or [Max (Top)] Enter a value [Enter] or ENTER [Min (Bottom)] Enter a value [Enter] or ENTER | Press the AMP/SCALE hard key. Press the Auto Scale soft key to automatically set optimum values. Press the Max (Top) soft key. Use the numeric keys to input value. Press the Enter soft key or the ENTER hard key. Press the Min (Bottom) soft key. Use the numeric keys to input value. Press the Enter soft key or the ENTER hard key. |

AMP/SCALE



- n **AUTO SCALE:** The instrument can automatically set the scale to the minimum and maximum values on the Y-axis of the graph for optimum display of the traces measured. Each time the **Auto Scale** is selected, the top and bottom scales are set to the minimum and maximum values with margin on the Y-axis of the display screen.
- n **MAX (TOP):** Sets the maximum value of the Y-axis range.
- n **MIN (BOTTOM):** Sets the minimum value of the Y-axis range.

PERFORMING CALIBRATION

The instrument must be calibrated to get a reliable measurement result. For best results, set the frequency and calibrate the instrument immediately before performing any measurement.

- n Calibration accessories (optional).
- n Calibration Kit: Includes one 50 ohm load, one open standard, and one short standard.
- n Test Cable: Use a phase stable cable for reliable and consistent measurement results.

1 Port Calibration

(Reflection, DTF, Cable Loss, 1 Port Phase, Smith Chart)

The following figure illustrates the connection method when a port extension cable is used for calibration. To compensate errors caused by a port extension cable or adapters, perform an Open-Short-Load calibration including the port extension cable.

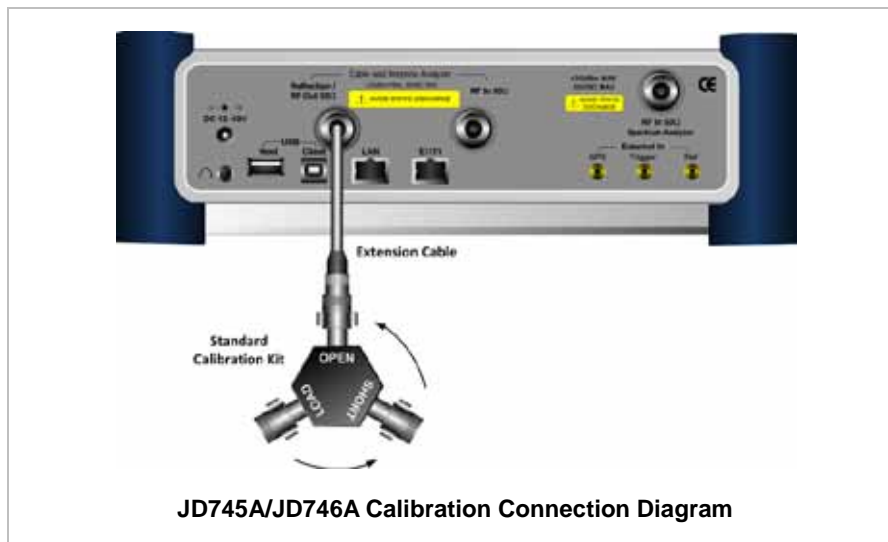

To minimize measurement errors, connect the port extension cable to the **Cable and Antenna Analyzer Reflection/RF Out** port on the instrument and then connect the Calibration Kit to the end of the extension cable. Do not add unnecessary extension cables or adapters.



Bending or moving the extension cable while making a measurement may cause errors in the measurement.

CALIBRATION PROCEDURE

Open-Short-Load calibration must be performed after setting frequency and connecting a test cable. When using an extension cable connected to the **Cable and Antenna Analyzer Reflection/RF Out** port, the calibration kit must be connected to the other end of the extension cable.

| Step | Description |
|--|---|
| 1. Select calibration menu MEASURE SETUP [Calibrate] | Press the MEASURE SETUP hot key. Press the Calibrate soft key. |

| | |
|--|--|
| <p>2. Calibrate Open standard Connect an OPEN standard</p> <p>[Continue]</p> | <p>Connect the OPEN connector of the CAL Kit to the Cable and Antenna Analyzer Reflection/RF Out port or the other end of an extension cable.</p> <p>Press the Continue soft key to start calibration. A progress bar is displayed to show the progress in percentage.</p> |
| <p>3. Calibrate Short standard Connect a SHORT standard</p> <p>[Continue]</p> | <p>Connect the SHORT connector of the CAL Kit to the Cable and Antenna Analyzer Reflection/RF Out port or the other end of an extension cable.</p> <p>Press the Continue soft key to start calibration. A progress bar is displayed to show the progress in percentage.</p> |
| <p>4. Calibrate 50Ω Load standard Connect a 50Ω Load standard</p> <p>[Continue]</p> | <p>Connect the LOAD connector of the CAL Kit to the Cable and Antenna Analyzer Reflection/RF Out port or the other end of an extension cable.</p> <p>Press the Continue soft key to start calibration. A progress bar is displayed to show the progress in percentage.</p> |
| <p>5. Check calibration status</p> | <p>Check the Cal Status on the display screen. The status is changed to On from Off after successful completion of Open-Short-Load calibration.</p> |

2 Port Calibration

(2 Port Measurements - Vector and Scalar)

The following figure illustrates the connection method for 2 port calibration. To compensate errors caused by a port extension cable or adapters, perform an Open-Short-Load calibration including the port extension cable.



To minimize measurement errors in measurements, do not add additional extension cables or adapters while performing measurement.

VECTOR MEASUREMENT

Perform O-S-L Calibration to Reflection/RF Out Port



Connect THRU Cable between Reflection/RF Out Port and RF In Port

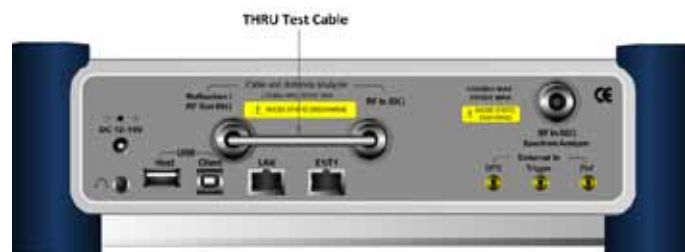

JD745A/JD746A Calibration Connection Diagram

VECTOR CALIBRATION PROCEDURE

Calibration must be performed after setting frequency.

| Step | Description |
|--|--|
| 1. Select calibration menu MEASURE SETUP [Calibrate] | Press the MEASURE SETUP hot key. Press the Calibrate soft key. |
| 2. Calibrate Open standard Connect an OPEN standard [Continue] | Connect the OPEN connector of the CAL Kit to the Cable and Antenna Analyzer Reflection/RF Out port. Press the Continue soft key to start calibration. A progress bar is displayed to show the progress in percentage. |
| 3. Calibrate Short standard Connect a SHORT standard [Continue] | Connect the SHORT connector of the CAL Kit to the Cable and Antenna Analyzer Reflection/RF Out port. Press the Continue soft key to start calibration. A progress bar is displayed to show the progress in percentage. |

| | |
|--|--|
| <p>4. Calibrate 50Ω Load standard Connect a 50Ω Load standard</p> <p>[Continue]</p> | <p>Connect the LOAD connector of the CAL Kit to the Cable and Antenna Analyzer Reflection/RF Out port.</p> <p>Press the Continue soft key to start calibration. A progress bar is displayed to show the progress in percentage.</p> |
| <p>5. Calibrate THRU Connect a test cable</p> <p>[Continue]</p> | <p>Connect the Reflection/RF Out port and the RF In port for the Cable and Antenna Analyzer with using the test cable and the proper adapter.</p> <p>Press the Continue soft key to start calibration. A progress bar is displayed to show the progress in percentage.</p> |
| <p>6. Check calibration status</p> | <p>Check the Cal Status on the display screen. The status is changed to On from Off after successful completion of calibration.</p> |

SCALAR MEASUREMENT

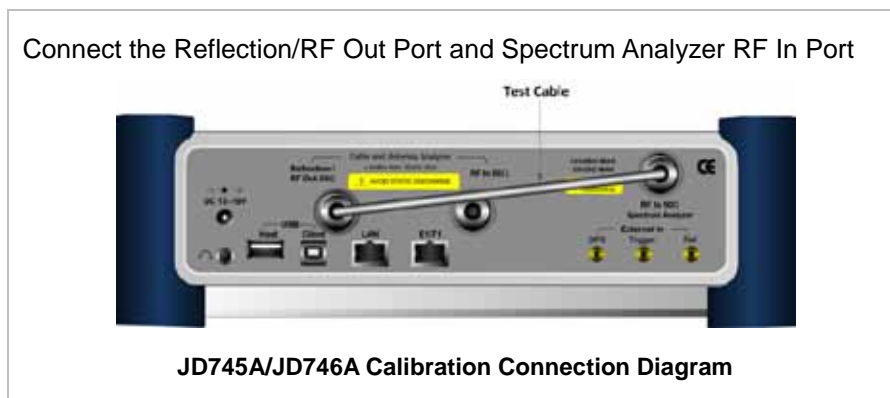

SCALAR CALIBRATION PROCEDURE

Calibration must be performed after setting frequency.

| Step | Description |
|---|--|
| <p>1. Select calibration menu MEASURE SETUP [Calibrate]</p> | <p>Press the MEASURE SETUP hot key. Press the Calibrate soft key.</p> |
| <p>2. Calibrate Connect a test cable</p> <p>[Continue]</p> | <p>Connect the Reflection/RF Out port for the Cable and Antenna Analyzer and the RF In port for the Spectrum Analyzer with using the test cable.</p> <p>Press the Continue soft key to start calibration. A progress bar is displayed to show the progress in percentage.</p> |

| | |
|-----------------------------|---|
| 3. Check calibration status | Check the Cal Status on the display screen. The status is changed to On from Off after successful completion of calibration. |
|-----------------------------|---|

REFLECTION MEASUREMENT

The Reflection measurement in VSWR or Return Loss can be used to characterize cable and antenna system to ensure impedance performance and signal reflection characteristics of the cell site.

Connecting Cables for Measurement

| Step | Description |
|--|--|
| 1. Connect the extension cable to the instrument | Connect the one end of the port extension cable to the Cable and Antenna Analyzer Reflection/RF Out port of the instrument. |
| 2. Connect the extension cable to antenna or feed line | Connect the other end of the port extension cable to an antenna or feed line. Measurement result is displayed on the display screen. |

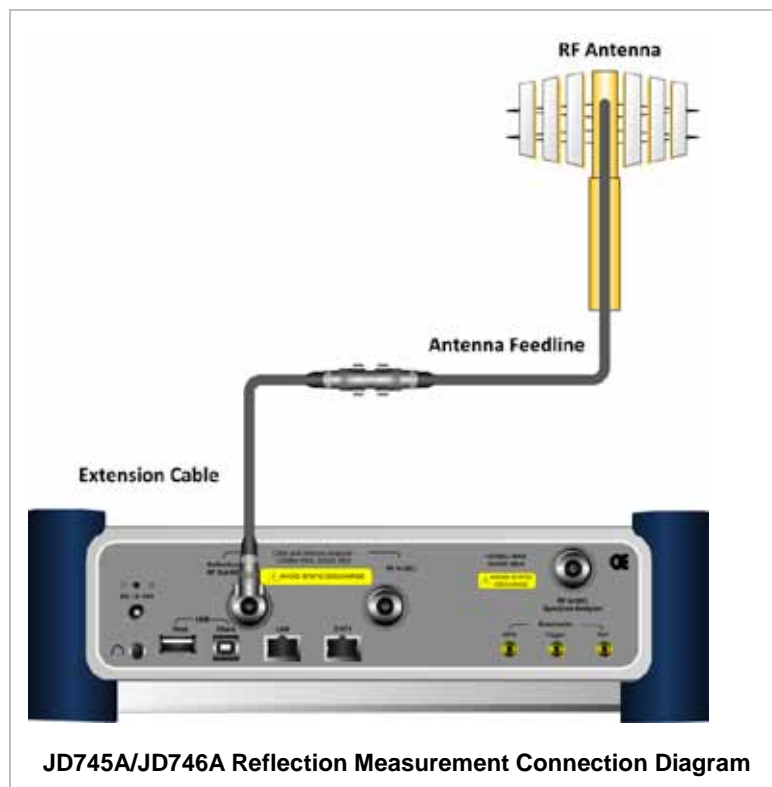



After calibration, do not change the connection of the port extension cable or the frequency setting. It may cause a measurement error.



Changing any frequency settings will automatically turn the calibration status to OFF on the display screen, which requires re-calibration to proceed next measurement.



The maximum allowable input level of the instrument is +25 dBm. Do not connect the **Cable and Antenna Analyzer Reflection/RF Out 50 Ω** port of the instrument directly to the output port of the system. An over power input degrades the performance of the instrument and may cause a malfunction of the instrument.



Do not connect the instrument to the antenna when there is a risk of lightning. Electric shock may cause malfunction of or damage to the instrument.

Measurement Procedure

| Step | Description |
|---|---|
| 1. Select the mode MODE [Cable & Antenna Analyzer] [Reflection (VSWR)] or [Reflection (Return Loss)] | Press the MODE hard key. Press the Cable & Antenna Analyzer soft key. Press the Reflection (VSWR) or Reflection (Return Loss) soft key to select the measurement mode. |
| 2. Perform calibration | Refer to the 1 Port Calibration in the Performing Calibration section. It explains how to perform calibration properly. |
| 3. Connect cables for measurement | Refer to the Connecting Cables for Measurement in the Reflection Measurement section. |
| 4. Set the measurement parameters MEASURE SETUP [Data Points] <126>, <251>, <501>, or <1001> [Bias Tee] <On> or <Off> Enter a value [Enter] or ENTER | Press the MEASURE SETUP hot key. Press the Data Points soft key. Every time this soft key is pressed, the selection moves among 126, 251, 501, and 1001. Press the Bias Tee soft key to turn it on or off. Toggle this soft key between On and Off . Use the numeric keys between 12 and 32 with 0.1 V step. Press the Enter soft key or the ENTER hard key. |

Changing Data Points

MEASURE SETUP



- n **DATA POINTS:** Sets data points to change the resolution of the measurement. Changing the Data Points does not affect the calibration state.

Setting Bias Tee

MEASURE SETUP



- n **BIAS TEE:** Turns the bias tee option on or off. The instrument's optional built-in bias tee supplies power up from 12 VDC to 32 VDC to active devices through the instrument's RF In port eliminating the need of an external power supplies.
- n **OUTPUT POWER:** Sets output power to **0 dBm** or **-30 dBm**. 0 dBm is set by default. When an amplifier's reflection is measured, it is recommended to change this output power level to -30 dBm and then re-calibrate. Changing to -30 dBm results in reduced measurement dynamic range.

Measurement Example



DTF MEASUREMENT

The DTF measurement can be used to accurately identify faulty location within cable and feed line system while magnitude discontinuities displays in VSWR or Return Loss over distance in meter or foot.

Connecting Cables for Measurement

| Step | Description |
|--|--|
| 1. Connect the extension cable to the instrument | Connect the one end of the port extension cable to the Cable and Antenna Analyzer Reflection/RF Out port of the instrument. |
| 2. Connect the extension cable to antenna or feed line | Connect the other end of the port extension cable to an antenna or feed line. Measurement result is displayed on the display screen. |

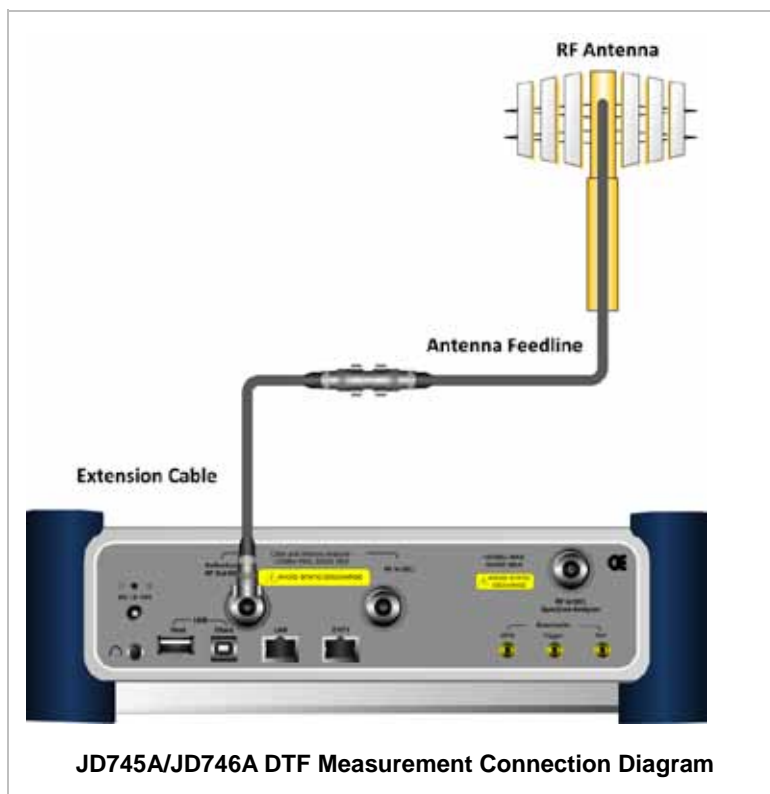

If O-S-L calibration has been done at the end of the port extension cable for DTF measurement, the length of the port extension cable is compensated automatically and is not included in the distance to the point of discontinuity.



Changing any frequency settings will automatically turn the calibration status to OFF on the display screen, which requires re-calibration to proceed next measurement.



The maximum allowable input level of the instrument is +25 dBm. Do not connect the **Cable and Antenna Analyzer Reflection/RF Out 50 Ω** port of the instrument directly to the output port of the system. An over power input degrades the performance of the instrument and may cause a malfunction of the instrument.



Do not connect the instrument to the antenna when there is a risk of lightning. Electric shock may cause malfunction of or damage to the instrument.

Measurement Procedure

| Step | Description |
|--|---|
| 1. Select the mode MODE [Cable & Antenna Analyzer] [DTF (VSWR)] or [DTF (Return Loss)] | Press the MODE hard key. Press the Cable & Antenna Analyzer soft key. Press the DTF (VSWR) or DTF (Return Loss) soft key to select the measurement mode. |
| 2. Perform calibration | Refer to the 1 Port Calibration in the Performing Calibration section. It explains how to perform calibration properly. |
| 3. Connect cables for measurement | Refer to the Connecting Cables for Measurement in the DTF Measurement section. |
| 4. Set the distance FREQ/DIST [Distance] Enter a value [Enter] | Press the FREQ/DIST hard key. Press the Distance soft key. Use the numeric keys to input value. Press the Enter soft key to complete the input. |
| 5. Set the measurement parameters MEASURE SETUP [Data Points] <126> , <251> , <501> , or <1001> [Bias Tee] <On> or <Off> Enter a value [Enter] or ENTER [DTF Setting] | Press the MEASURE SETUP hot key. Press the Data Points soft key. Every time this soft key is pressed, the selection moves among 126, 251, 501, and 1001. Press the Bias Tee soft key to turn it on or off. Toggle this soft key between On and Off . Use the numeric keys between 12 and 32 with 0.1 V step. Press the Enter soft key or the ENTER hard key. Press the DTF Setting soft key. |

| | |
|--|--|
| <p>[Prop Velocity] Enter a value [Enter] or ENTER</p> | <p>Press the Prop Velocity soft key. Use the numeric keys to input value. Press the Enter soft key or the ENTER hard key.</p> |
| <p>[Cable Loss] Enter a value [Enter] or ENTER</p> | <p>Press the Cable Loss soft key. Use the numeric keys to input value. Press the Enter soft key or the ENTER hard key.</p> |
| <p>[Metrics] <Meter> or <Foot></p> | <p>Press the Metrics soft key to change the setting. Toggle this soft key between Meter and Foot.</p> |
| <p>[Windowing] [Rectangular], [Blackman], [Nominal Side Lobe], [Low Side Lobe], or [Minimum Side Lobe]</p> | <p>Press the Windowing soft key. Press one of the soft keys to select a video filtering option.</p> |
| <p>[Cable List] [Standard Cable] or [Custom Cable]</p> | <p>Press the Cable List soft key. Press one of the soft keys to select.</p> |

Changing Distance



Sets the distance DTF measurements. The maximum measurable distance is displayed on the left side of the screen depending on the frequency setting. Any value within the maximum measurable distance can be set. Optimum resolution is achieved when the user setting distance is the same as the maximum measurable distance.

- n **DISTANCE:** Changes the distance in the DTF measurement. Values can be entered with the numeric keys. Pressing the **Enter** soft key or **ENTER** hard key completes the input.

Changing Data Points



- n **DATA POINTS:** Sets data points to change the resolution of the measurement. Changing the Data Points does not affect the calibration state.
- n **OUTPUT POWER:** Selects output power between **0 dBm** and **-30 dBm**. 0 dBm is set by default. When an amplifier's reflection is measured, it is recommended to change this output power level to -30 dBm and then re-calibrate. Changing to -30 dBm results in reduced measurement dynamic range.

Setting Bias Tee

MEASURE SETUP



- n **BIAS TEE:** Turns the bias tee option on or off. The instrument's optional built-in bias tee supplies power up from 12 VDC to 32 VDC to active devices through the instrument's RF In port eliminating the need of an external power supplies.

Changing DTF Setting

MEASURE SETUP



- n **DTF SETTING:** Sets the DTF setting.
 - Y **PROP VELOCITY:** Sets the relative propagation delay of a cable. It affects the calculation of the distance in the DTF measurement. Use the numeric keys to enter a value and press the **Enter** soft key to complete the input.
 - Y **CABLE LOSS:** Sets the loss per distance unit of a cable. It affects the peak level of the discontinuity in the DTF measurement. Use the numeric keys to enter a value and press the **Enter** soft key to complete the input.
 - Y **METRICS:** Selects the X-axis unit of the DTF measurement display to **Meter** or **Foot**.
 - Y **WINDOWING:** Selects video filtering to the display of the trace among **Rectangular**, **Blackman**, **Nominal Side Lobe**, **Low Side Lobe**, and **Minimum Side Lobe**.

Selecting Cable

MEASURE SETUP



- n **CABLE LIST:** Opens a list of coaxial cables stored in the instrument. The user can store additional cables to the instrument by using the application software JDViewer provided with the instrument.
- Y **STANDARD CABLE:** Opens the Cable List stored in the instrument.

| Step | Description |
|---|---|
| 1. Get the Cable list MEASURE SETUP [Cable List] [Standard Cable] | Press the MEASURE SETUP hot key. Press the Cable List soft key. Press the Standard Cable soft key to get the pop-up window |

| | |
|--------------------------------------|--|
| | of the list of cables stored in the instrument. |
| 2. Browse and highlight a cable name | Press the arrow keys, rotate the knob, or press the Page Up and the Page Down soft keys to highlight a cable name to select. Pressing the Add to Custom soft key will add the highlighted cable to the custom list. |
| 3. [Select] | Press the Select soft key or the center of the rotary knob. |

Y **CUSTOM CABLE:** Opens the cable list of the user's own that is stored in the instrument.

Measurement Example

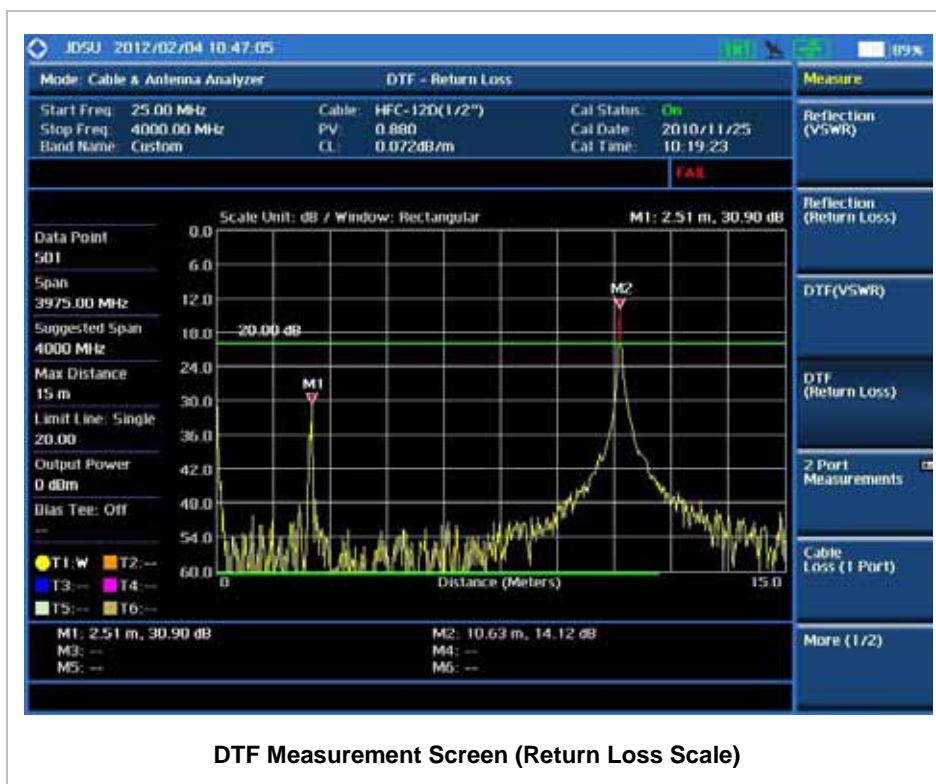

2 PORT MEASUREMENT (OPTION 001) - VECTOR

Vector measurement is used to perform faster and more accurate measurement with around 80 dB dynamic range. It also provides antenna isolation measurement. The user can determine DUT's S_{21} phase characteristic by selecting the measurement display type as Phase.

Connecting Cables for Measurement

| Step | Description |
|--|---|
| 1. Connect the Thru test cable to the instrument | Connect the one end of the Thru test cable to the Cable and Antenna Analyzer Reflection/RF Out port of the instrument and the other end of the cable to DUT. |
| 2. Connect the DUT to the instrument | Connect the DUT to the Cable and Antenna Analyzer RF In port of the instrument. Measurement result is displayed on the display screen. |

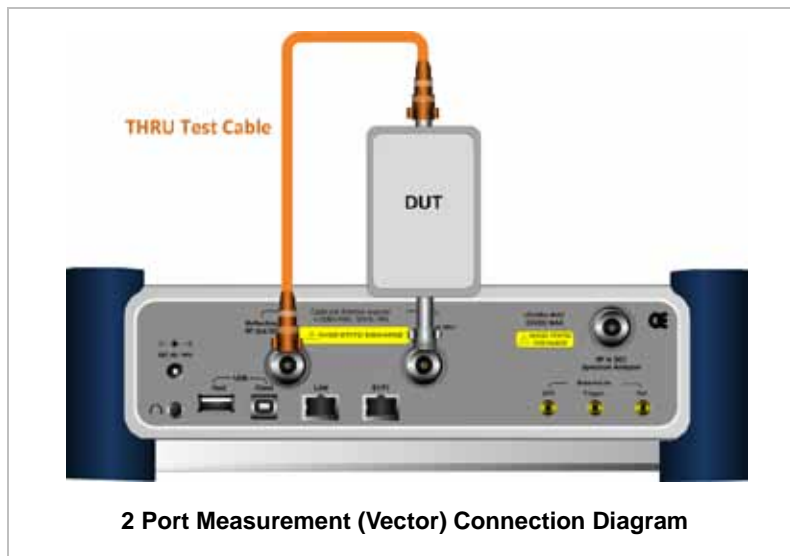

A proper level of input to the **Cable and Antenna Analyzer RF In 50 Ω** port is 0 dBm. When the input power is expected to be greater than 0 dBm, the RF In attenuation must be set on.



The maximum allowable input of **Cable and Antenna Analyzer RF In 50 Ω** port is +25 dBm.

Measurement Procedure

| Step | Description |
|---|---|
| 1. Select the mode MODE [Cable & Antenna Analyzer] [2 Port Measurements] [Vector] | Press the MODE hard key. Press the Cable & Antenna Analyzer soft key. Press the 2 Port Measurements soft key. Press the Vector soft key. |

| | |
|--|---|
| <p>2. Perform calibration</p> | <p>Refer to the 2 Port Calibration in the Performing Calibration section. It explains how to perform calibration properly.</p> |
| <p>3. Connect cables for measurement</p> | <p>Refer to the Connecting Cables for Measurement in the 2 Port Measurement - Vector section.</p> |
| <p>4. Set the measurement parameters</p> <p>MEASURE SETUP</p> <p>[Data Points] <126>, <251>, <501>, or <1001></p> <p>[Bias Tee] <On> or <Off> Enter a value [Enter] or ENTER</p> <p>[Output Power] <0 dBm> or <-30 dBm></p> <p>[RF In Atten] <On> or <Off></p> <p>[Display] <Magnitude> or <Phase></p> | <p>Press the MEASURE SETUP hot key.</p> <p>Press the Data Points soft key. Every time this soft key is pressed, the selection moves among 126, 251, 501, and 1001.</p> <p>Press the Bias Tee soft key to turn it on or off. Toggle this soft key between On and Off.</p> <p>Use the numeric keys between 12 and 32 with 0.1 V step. Press the Enter soft key or the ENTER hard key.</p> <p>Press the Output Power soft key. Toggle this soft key between 0 dBm and -30 dBm.</p> <p>Press the RF In Atten soft key. Toggle this soft key between On and Off.</p> <p>Press the Display soft key. Toggle this soft key between Magnitude and Phase.</p> |

Changing Data Points

MEASURE SETUP



- n **DATA POINTS:** Sets data points to change the resolution of the measurement. Changing the Data Points does not affect the calibration state.
- n **OUTPUT POWER:** Selects output power between **0 dBm** and **-30 dBm**. The output power 0 dBm is for a passive device measurement while -30 dBm for an active device measurement. Setting it to -30 dBm may result in reduced measurement dynamic range. Changing this output power setting requires re-calibration.
- n **RF IN ATTEN:** Sets RF In attenuation on or off. Default setting is Off. Toggle this soft key between **On** and **Off**. If the input power into the RF In port is expected to be greater than 0 dBm, set this RF In attenuation to On. It will prevent saturation of input and measurement error. Changing this setting requires re-calibration.

Setting Bias Tee

MEASURE SETUP



- n **BIAS TEE:** Turns the bias tee option on or off. The instrument's optional built-in bias tee supplies power up from 12 VDC to 32 VDC to active devices through the instrument's RF In port eliminating the need of an external power supplies.

Setting Display

MEASURE SETUP



- n **DISPLAY:** Sets the display type to Magnitude in dB or Phase in degree. Toggle this soft key between **Magnitude** and **Phase**.

Measurement Example

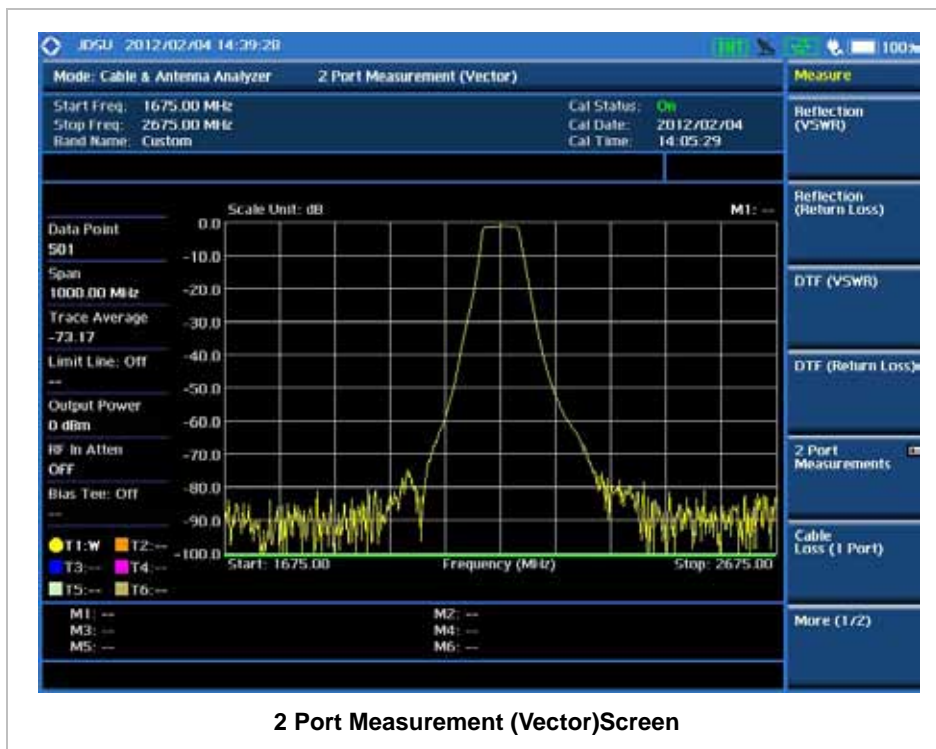

2 Port Measurement (Vector)Screen

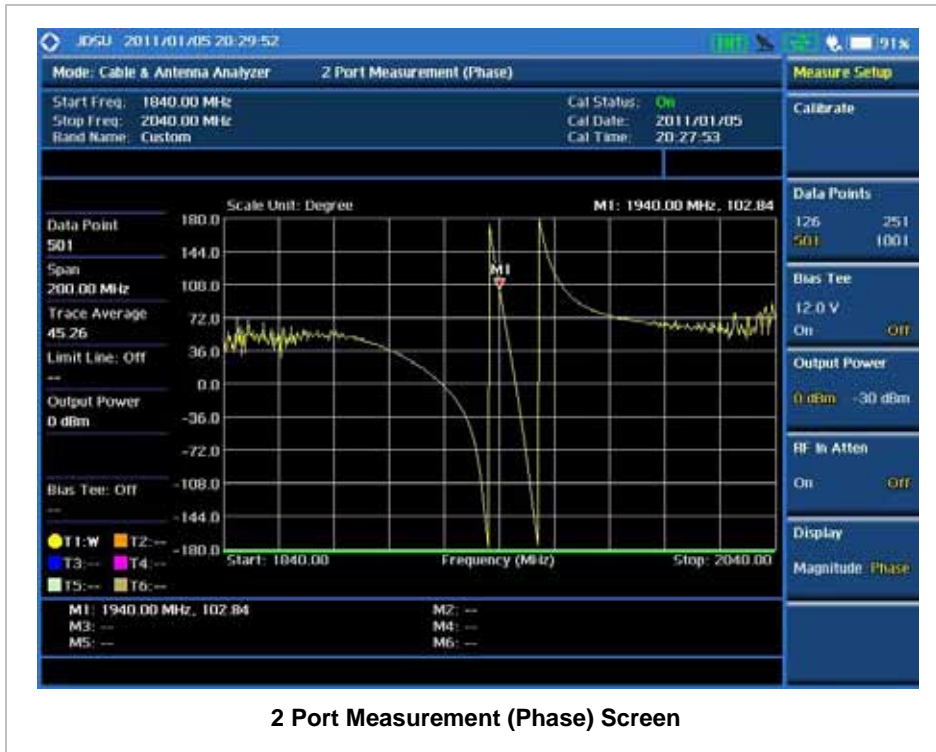

2 PORT MEASUREMENT (OPTION 001) - SCALAR

Scalar measurement enables full characterization of DUT with dynamic greater than 100 dB.

Connecting Cables for Measurement

| Step | Description |
|---|--|
| 1. Connect the test cable to the instrument | Connect the one end of the test cable to the Cable and Antenna Analyzer Reflection/RF Out port of the instrument and the other end of the cable to DUT. |
| 2. Connect the DUT to the instrument | Connect the DUT to the Spectrum Analyzer RF In port of the instrument. Measurement result is displayed on the display screen. |

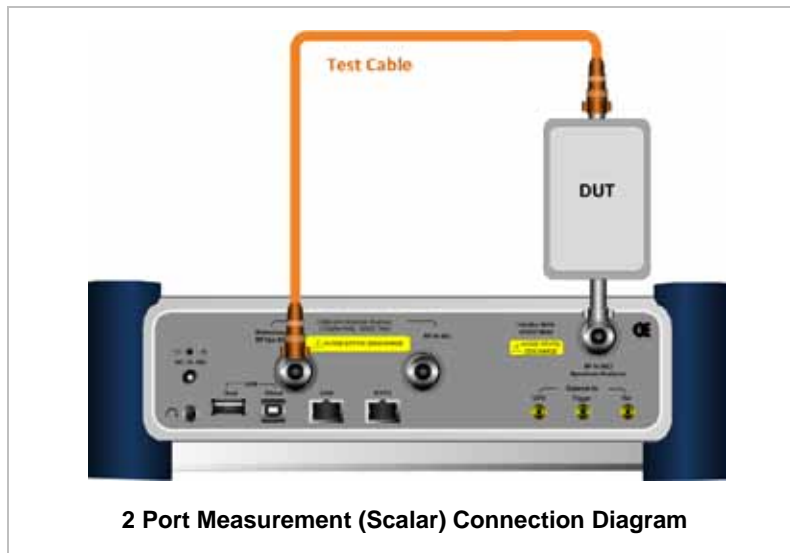

2 Port Measurement (Scalar) Connection Diagram



The maximum allowable input of **Spectrum Analyzer RF In 50 Ω** port is +20 dBm.

Measurement Procedure

| Step | Description |
|--|---|
| 1. Select the mode MODE [Cable & Antenna Analyzer] [2 Port Measurements] [Scalar] | Press the MODE hard key. Press the Cable & Antenna Analyzer soft key. Press the 2 Port Measurements soft key. Press the Scalar soft key. |
| 2. Perform calibration | Refer to the 2 Port Calibration in the Performing Calibration section. It explains how to perform calibration properly. |
| 3. Connect cables for measurement | Refer to the Connecting Cables for Measurement in the 2 Port Measurement (Scalar) section. |
| 4. Set the measurement parameters MEASURE SETUP [Data Points] <126>, <251>, <501>, or <1001> [RF In Atten] Enter a value [dB] or ENTER | Press the MEASURE SETUP hot key. Press the Data Points soft key. Every time this soft key is pressed, the selection moves among 126, 251, 501, and 1001. Press the RF In Atten soft key to set attenuation value. Use the numeric keys to input value between 10 and 50. Press the dB unit soft key or the ENTER hard key. |

Changing Data Points

MEASURE SETUP



- n **DATA POINTS:** Sets data points to change the resolution of the measurement. Changing the Data Points does not affect the calibration state.
- n **OUTPUT POWER:** Selects output power between **0 dBm** and **-30 dBm**. 0 dBm is set by default. When an amplifier's reflection is measured, it is recommended to change this output power level to -30 dBm and then re-calibrate. Changing to -30 dBm results in reduced measurement dynamic range.
- n **RF IN ATTEN:** Sets RF In attenuation value between 10 dB and 50 dB. Changing this setting requires re-calibration.

Measurement Example

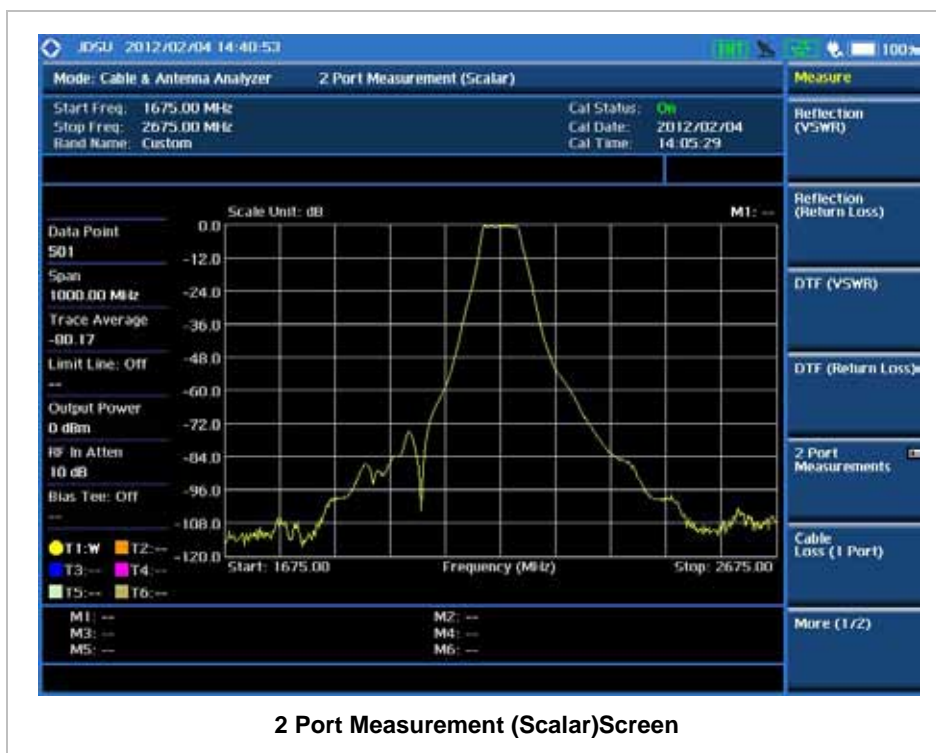

CABLE LOSS (1 PORT) MEASUREMENT

The Cable Loss (1 Port) measurement quantifies signal loss in a cable or other device without

connecting both ends of the cable or device to the instrument. This measurement can be especially useful in measuring the loss of feed line connected to the antenna.

Connecting Cables for Measurement

| Step | Description |
|---------------------------------|--|
| 1. Connect the cable under test | Connect the one end of the cable under test to the Cable and Antenna Analyzer Reflection/RF Out port of the instrument. |
| 2. Connect the Cal Kit | Connect the Short standard of the Cal Kit to the other end of the cable under test. Measurement result is displayed on the display screen. |

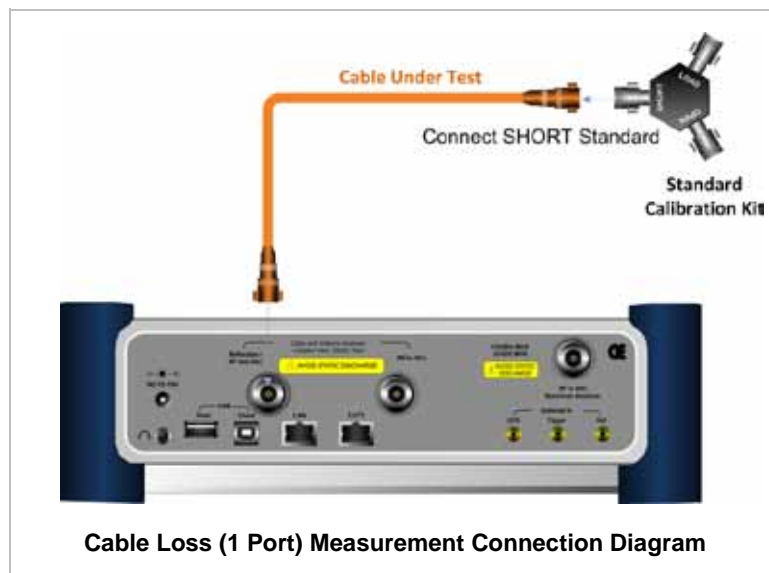

Measurement Procedure

| Step | Description |
|--|--|
| 1. Select the mode MODE [Cable & Antenna Analyzer] [Cable Loss (1 Port)] | Press the MODE hard key. Press the Cable & Antenna Analyzer soft key. Press the Cable Loss (1 Port) soft key. |
| 2. Perform calibration | Refer to the 1 Port Calibration in the Performing Calibration section. It explains how to perform calibration properly. |
| 3. Connect cables for measurement | Refer to the Connecting Cables for Measurement in the Cable Loss (1 Port) Measurement section. |
| 4. Set the measurement parameters MEASURE SETUP | Press the MEASURE SETUP hot key. |

| | |
|--|--|
| <p>[Data Points] <126>, <251>, <501>, or <1001></p> | <p>Press the Data Points soft key. Every time this soft key is pressed, the selection moves among 126, 251, 501, and 1001.</p> |
| <p>[Bias Tee] <On> or <Off> Enter a value [Enter] or ENTER</p> | <p>Press the Bias Tee soft key to turn it on or off. Toggle this soft key between On and Off. Use the numeric keys between 12 and 32 with 0.1 V step. Press the Enter soft key or the ENTER hard key.</p> |

Changing Data Points

MEASURE SETUP



- n **DATA POINTS:** Sets data points to change the resolution of the measurement. Changing the Data Points does not affect the calibration state.
- n **OUTPUT POWER:** Selects output power between **0 dBm** and **-30 dBm**. 0 dBm is set by default. When an amplifier's reflection is measured, it is recommended to change this output power level to -30 dBm and then re-calibrate. Changing to -30 dBm results in reduced measurement dynamic range.

Setting Bias Tee

MEASURE SETUP



- n **BIAS TEE:** Turns the bias tee option on or off. The instrument's optional built-in bias tee supplies power up from 12 VDC to 32 VDC to active devices through the instrument's RF In port eliminating the need of an external power supplies.

Measurement Example



1 PORT PHASE MEASUREMENTS

The Cable and Antenna Analyzer provides 1 port phase measurement for the user to turn DUT's impedance matching and phase match cables.

Connecting Cables for Measurement

| Step | Description |
|--|--|
| 1. Connect the extension cable to the instrument | Connect the one end of the port extension cable to the Cable and Antenna Analyzer Reflection/RF Out port of the instrument. |
| 2. Connect the extension cable to antenna or feed line | Connect the other end of the port extension cable to an antenna or feed line. Measurement result is displayed on the display screen. |

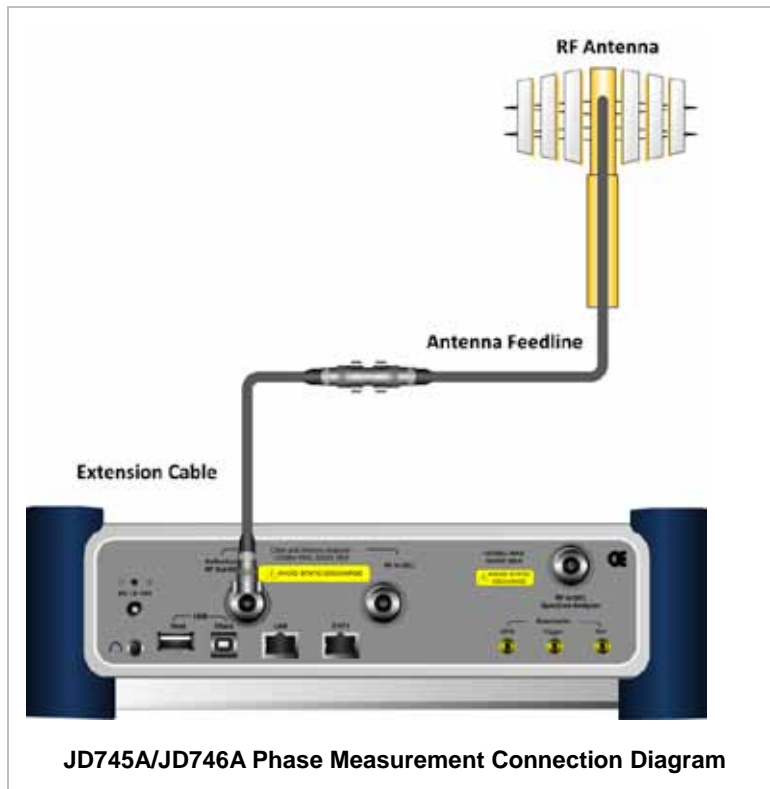

After calibration, do not change the connection of the port extension cable or the frequency setting. It may cause a measurement error.



Changing any frequency settings will automatically turn the calibration status to OFF on the display screen, which requires re-calibration to proceed next measurement.



The maximum allowable input level of the instrument is +25 dBm. Do not connect the **Cable and Antenna Analyzer Reflection/RF Out 50 Ω** port of the instrument directly to the output port of the system. An over power input degrades the performance of the instrument and may cause a malfunction of the instrument.



Do not connect the instrument to the antenna when there is a risk of lightning. Electric shock may cause malfunction of or damage to the instrument.

Measurement Procedure

| Step | Description |
|--|--|
| 1. Select the mode MODE [Cable & Antenna Analyzer] | Press the MODE hard key. Press the Cable & Antenna Analyzer soft key. |

| | |
|---|--|
| <p>[More (1/2)] [1 Port Phase]</p> | <p>Press the More (1/2) soft key. Press the 1 Port Phase soft key.</p> |
| <p>2. Perform calibration</p> | <p>Refer to the 1 Port Calibration in the Performing Calibration section. They explain how to perform calibration properly.</p> |
| <p>3. Connect cables for measurement</p> | <p>Refer to the Connecting Cables for Measurement in the 1 Port Measurement section.</p> |
| <p>4. Set the measurement parameters MEASURE SETUP [Data Points] <126>, <251>, <501>, or <1001> [Bias Tee] <On> or <Off> Enter a value [Enter] or ENTER</p> | <p>Press the MEASURE SETUP hot key. Press the Data Points soft key. Every time this soft key is pressed, the selection moves among 126, 251, 501, and 1001. Press the Bias Tee soft key to turn it on or off. Toggle this soft key between On and Off. Use the numeric keys between 12 and 32 with 0.1 V step. Press the Enter soft key or the ENTER hard key.</p> |

MEASURE SETUP

- n **DATA POINTS:** Sets data points to change the resolution of the measurement. Changing the Data Points does not affect the calibration state.
- n **OUTPUT POWER:** Selects output power between **0 dBm** and **-30 dBm**. 0 dBm is set by default. When an amplifier's reflection is measured, -30 dBm power is recommended. Changing this output power level to -30 dBm results in reduced measurement dynamic range.

Setting Bias Tee

MEASURE SETUP

- n **BIAS TEE:** Turns the bias tee option on or off. The instrument's optional built-in bias tee supplies power up from 12 VDC to 32 VDC to active devices through the instrument's RF In port eliminating the need of an external power supplies.

Measurement Example

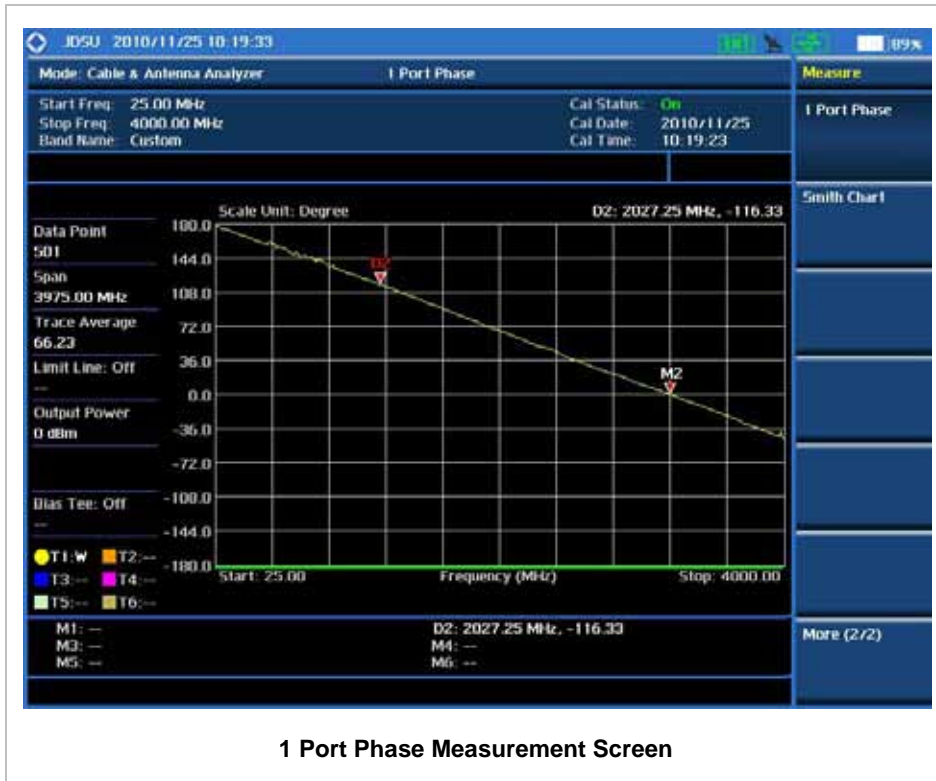

SMITH CHART MEASUREMENT

The Cable and Antenna Analyzer provides Smith Chart for the user to turn DUTs' impedance matching.

Connecting Cables for Measurement

| Step | Description |
|--|--|
| 1. Connect the extension cable to the instrument | Connect the one end of the port extension cable to the Cable and Antenna Analyzer Reflection/RF Out port of the instrument. |
| 2. Connect the extension cable to antenna or feed line | Connect the other end of the port extension cable to an antenna or feed line. Measurement result is displayed on the display screen. |

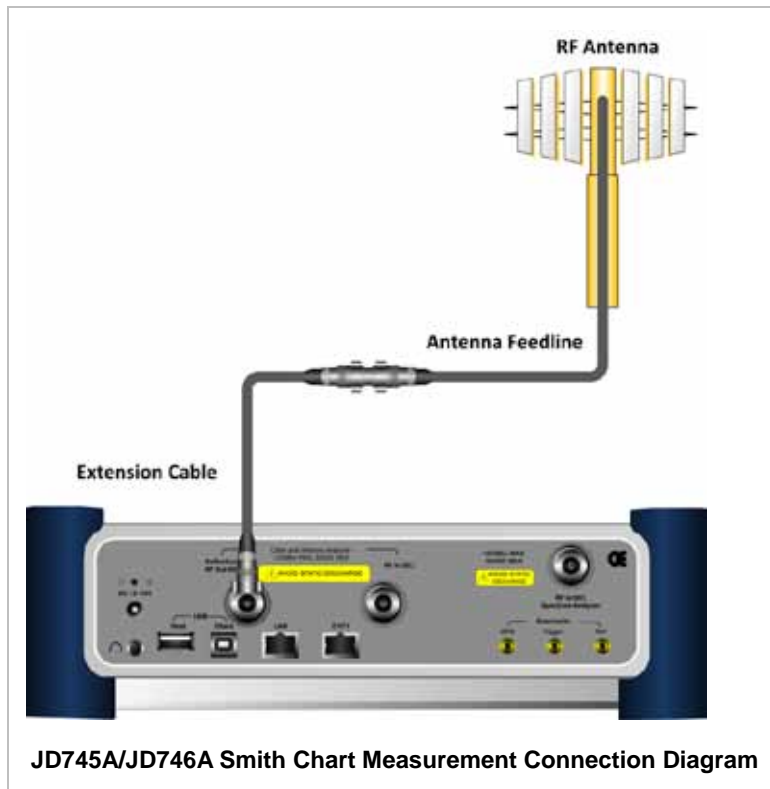

After calibration, do not change the connection of the port extension cable or the frequency setting. It may cause a measurement error.



Changing any frequency settings will automatically turn the calibration status to OFF on the display screen, which requires re-calibration to proceed next measurement.



The maximum allowable input level of the instrument is +25 dBm. Do not connect the **Cable and Antenna Analyzer Reflection/RF Out 50 Ω** port of the instrument directly to the output port of the system. An over power input degrades the performance of the instrument and may cause a malfunction of the instrument.



Do not connect the instrument to the antenna when there is a risk of lightning. Electric shock may cause malfunction of or damage to the instrument.

Measurement Procedure

| Step | Description |
|--|--|
| 1. Select the mode MODE [Cable & Antenna Analyzer] | Press the MODE hard key. Press the Cable & Antenna Analyzer soft key. |

| | |
|---|---|
| <p>[More (1/2)] [Smith Chart]</p> | <p>Press the More (1/2) soft key. Press the Smith Chart soft key.</p> |
| <p>2. Perform calibration</p> | <p>Refer to the 1 Port Calibration in the Performing Calibration section. They explain how to perform calibration properly.</p> |
| <p>3. Connect cables for measurement</p> | <p>Refer to the Connecting Cables for Measurement in the Smith Chart Measurement section.</p> |
| <p>4. Set the measurement parameters</p> <p>MEASURE SETUP</p> <p>[Data Points] <126>, <251>, <501>, or <1001></p> <p>[Bias Tee] <On> or <Off> Enter a value [Enter] or ENTER</p> | <p>Press the MEASURE SETUP hot key.</p> <p>Press the Data Points soft key. Every time this soft key is pressed, the selection moves among 126, 251, 501, and 1001.</p> <p>Press the Bias Tee soft key to turn it on or off. Toggle this soft key between On and Off.</p> <p>Use the numeric keys between 12 and 32 with 0.1 V step.</p> <p>Press the Enter soft key or the ENTER hard key.</p> |

Changing Data Points

MEASURE SETUP



- n **DATA POINTS:** Sets data points to change the resolution of the measurement. Changing the Data Points does not affect the calibration state.
- n **OUTPUT POWER:** Selects output power between **0 dBm** and **-30 dBm**. 0 dBm is set by default. When an amplifier's reflection is measured, it is recommended to change this output power level to -30 dBm and then re-calibrate. Changing to -30 dBm results in reduced measurement dynamic range.

Setting Bias Tee

MEASURE SETUP



- n **BIAS TEE:** Turns the bias tee option on or off. The instrument's optional built-in bias tee supplies power up from 12 VDC to 32 VDC to active devices through the instrument's RF In port eliminating the need of an external power supplies.

Measurement Example

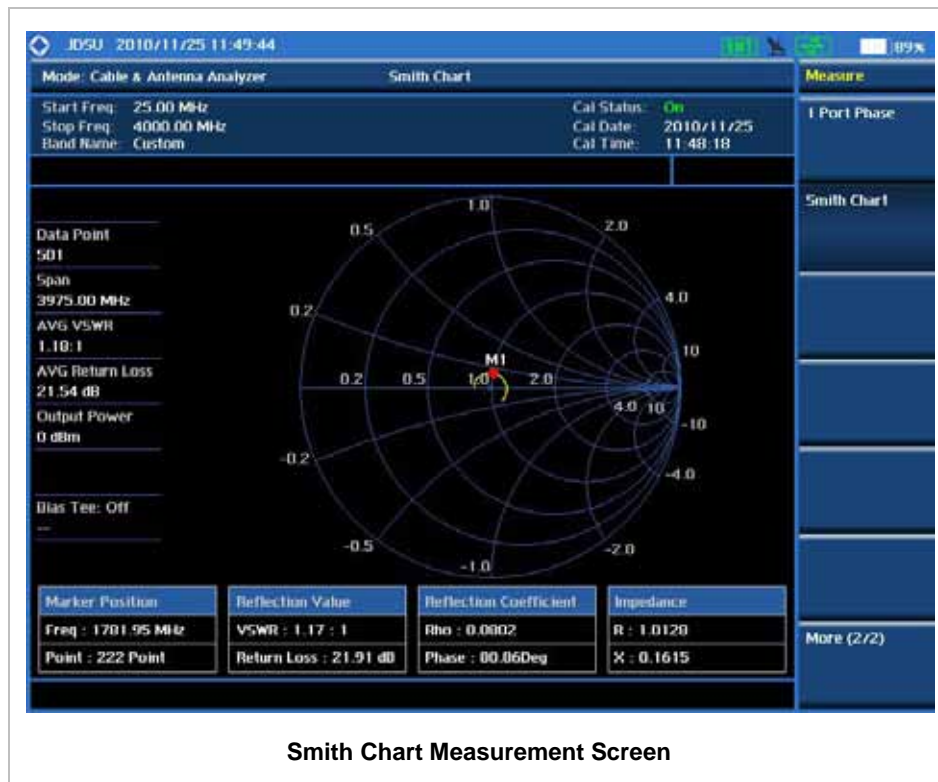

ANALYSIS

Using Marker

MARKER



Marker is used to get the information about a specific trace. Six markers can be set on the display and each marker can be used independently. The X and Y coordinates of the trace are displayed when the marker is placed on any position of the trace. The position displaying the marker's X and Y coordinates may be slightly different for each measurement mode and refer to the description of each measurement. There are three different marker types available: Normal, Delta, and Delta pair. Marker position can be set manually by entering numeric values (frequency) when one of the marker types is selected.

- n **SELECT MARKER:** Selects an active marker whose position can be changed with the rotary knob or the arrow keys. The assigned number of the active marker is displayed in the **Select Marker** menu box and the active marker number is also displayed right next to the active marker on the trace when the **Marker View** is set to **On**.

- n **MARKER VIEW:** Displays the selected marker on the screen or hides it. When the **Marker View** is turned off and then on again in the same measurement mode, markers appear at the previous positions. If a measurement mode is changed, markers are not restored to their previous positions.
- n **NORMAL:** This Normal marker type provides the reading of a marker position on the trace along with the marker number between 1 and 6.
- n **DELTA:** This Delta marker type is associated with a Normal marker. A Normal marker must be set before a Delta marker is set. When the Delta marker is set, the position set by the Delta marker becomes the reference position of the Normal marker and the marker's X and Y values displays the difference compared with the Delta marker. *This setting is not used in the Smith Chart measurement mode.*
- n **DELTA PAIR:** This Delta Pair marker type is associated with a Normal marker. A Normal marker must be set before a Delta Pair marker is set. When the Delta Pair marker is set, the position set by the Delta Pair marker becomes the reference position of the Normal marker and the marker's X and Y values displays the difference compared with the Delta Pair marker. The reference position will be varied in accordance with trace change. *This setting is not used in the Smith Chart measurement mode.*
- n **MARKER ALL OFF:** Turns all the markers the screen off. When the Marker View is selected for those markers, the instrument displays those markers back at the previous position. If a measurement mode is changed, current settings are not restored. *This setting is not used in the Smith Chart measurement mode.*

Using Peak Search

PEAK SEARCH



Each time the Peak Search soft key is pressed, the active marker is positioned at the highest peak of the trace. *This setting is not used in the Smith Chart measurement mode.*

- n **PEAK SEARCH:** Moves the active marker to the highest peak of the trace.
- n **NEXT PEAK:** Moves the active marker to the second highest peak of the trace.
- n **NEXT PEAK RIGHT:** Moves the active marker to the highest peak to the right of its current position.
- n **NEXT PEAK LEFT:** Moves the active marker to the highest peak to the left of its current position.
- n **MIN SEARCH:** Moves the active marker to the lowest peak of the trace.

Power Meter

This Power Meter function includes the RF power meter as the standard feature and the optical power meter as the Option 013. It enables power measurement without carrying a separate power meter and additional tools. This instrument works as a highly accurate RF power meter with an optional external power sensor and optical power meter with an optical power sensor.

In this Chapter

| | |
|----------------------------------|----|
| Using Power Meter | 2 |
| Display Overview | 2 |
| Connecting a Cable | 4 |
| Internal Power Measurement | 4 |
| External Power Measurement | 5 |
| Optical Power Measurement | 7 |
| Internal Power Measurement | 7 |
| Setting Mode | 7 |
| Setting Frequency | 8 |
| Setting Sweep Mode | 10 |
| Setting Display | 10 |
| Measurement Procedure | 11 |
| Setting Limit | 12 |
| Measurement Example | 13 |
| External Power Measurement | 13 |
| Setting Mode | 13 |
| Setting Frequency | 14 |
| Setting Display | 14 |
| Measurement Procedure | 15 |
| Setting Limit | 16 |
| Measurement Example | 17 |
| Optical Power Measurement | 17 |
| Setting Mode | 18 |
| Setting Wavelength | 18 |
| Setting Display | 18 |
| Measurement Procedure | 19 |
| Setting Limit | 20 |
| Measurement Example | 20 |

(Rev. 6.0)

USING POWER METER

The RF power meter of the JD740A series uses power measurement based on spectrum measurement results to provide an accurate power measurement result unlike a general spectrum analyzer, of which power accuracy may be degraded if the span is set too wide.

The power meter also provides Pass/Fail testing with user-defined lower and upper limits and a Pass/Fail indicator.

INTERNAL POWER MEASUREMENT

The internal power measurement of the JD740A series collects powers from the raw data of spectrum analyzer in the optimal span and integrates the powers up to the specified user span, which results in an accurate power measurement, independent of the span setting.

EXTERNAL POWER MEASUREMENT

This instrument performs radio output power measurement with the use of optional external power sensors including JD730 series power sensors. It serves as the highly accurate RF power meter and gives wider range of power measurement. There are two types of power sensors. Directional power sensors are used in in-service power measurement. Terminating power sensors are used in out-of-service power measurement.

OPTICAL POWER MEASUREMENT

The optical power measurement is available in conjunction with MP-series power sensor which measures optical power via a USB connection. Its size, functionality, and ease-of-use make it an extremely useful and practical tool when testing optical power levels.

DISPLAY OVERVIEW

Measurement Mode Information: Power Meter

Power Meter Setting Information: Frequency/Channel and Span setting and High/Low Limit setting

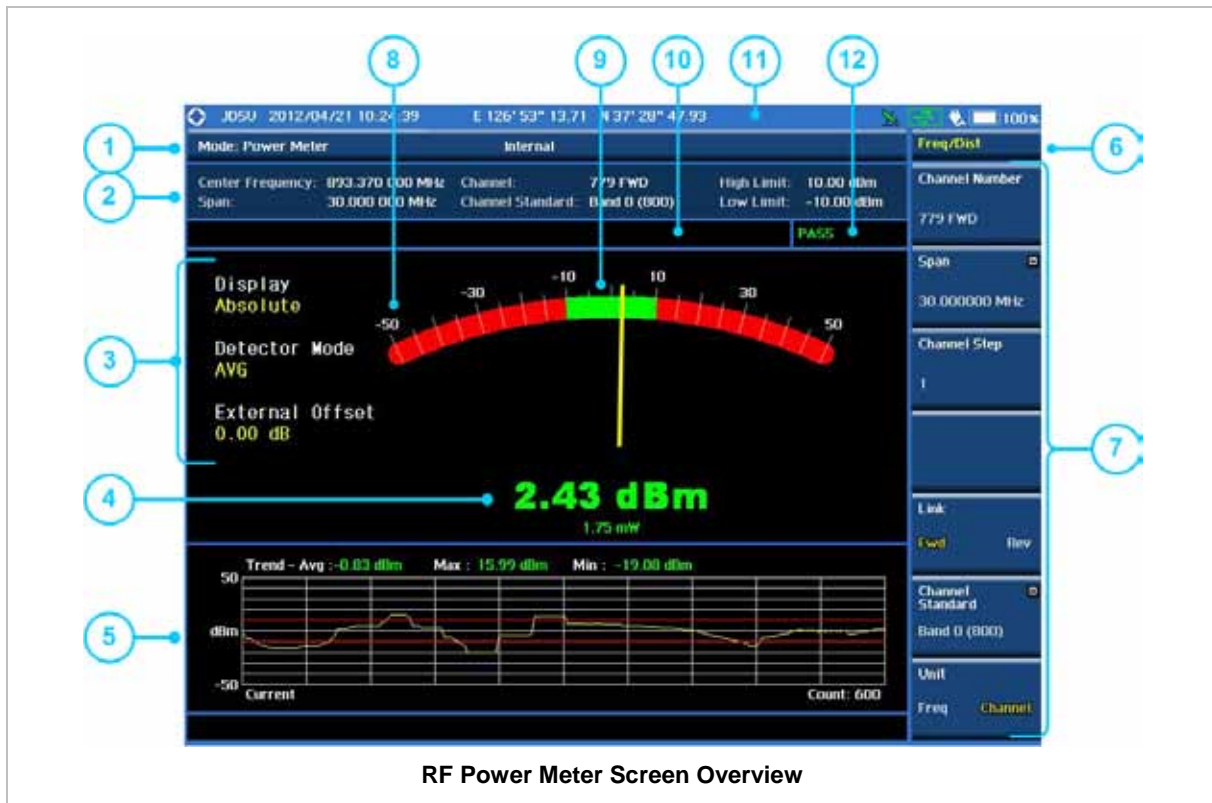

Measurement Setting Information

- Display Mode Information: ABS (Absolute) or REL (Relative)
- Detector Mode Information: AVG (Average) or Peak
- User offset (External Offset) Setting Information

Measurement Result Display (dBm and Watt)

Measurement Trend Window: Shows power variations over time with Avg, Max, and Min value

Screen Menu Title

Screen Menu and Sub-menu

Display Range (Min/Max) Display – user settable

Measurement Range (High/Low Limit) Display – user settable

User Input Window: Activates when user input menu or key is selected. Pressing ESC hard key will cancel or deactivate user input window. Inactivate user input window before using hot keys.

NOTE: It is very important to inactivate the user input window when you intend to use the hot key menu on the numeric keys.

System Information

- Date and Time
- Positioning Information (Longitude and Latitude). It is available only when a GPS antenna is connected. Frequency reference is automatically set to GPS in the System menu when a GPS antenna is connected.
- Frequency Reference Indicator: INT for internal and EXT for external. The EXT icon is green when an external reference is locked or red when the external reference is not

locked. When a GPS antenna is connected, this space will be blank.

- GPS Indicator: Color of the GPS icon changes among green, yellow and gray depending on locking status.
- USB Indicator
- DC Input Power Indicator
- Battery Indicator

Pass/Fail Indicator

CONNECTING A CABLE

Internal Power Measurement

DIRECT CONNECTION

Connect the **Spectrum Analyzer RF In 50 Ω** port of the JD740A series and the PA output port of BTS.

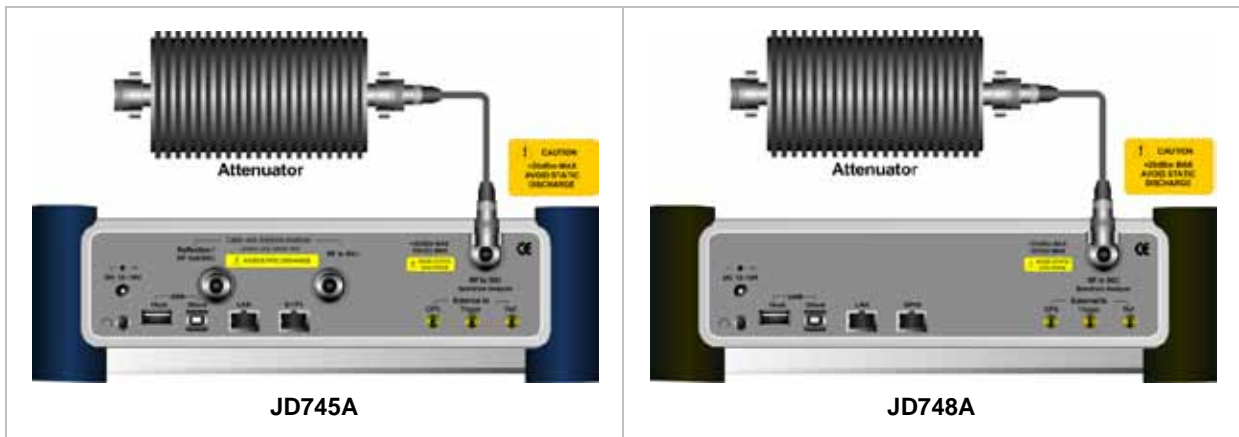

INDIRECT CONNECTION

Connect the **Spectrum Analyzer RF In 50 Ω** port of the JD740A series and the monitor port of BTS.

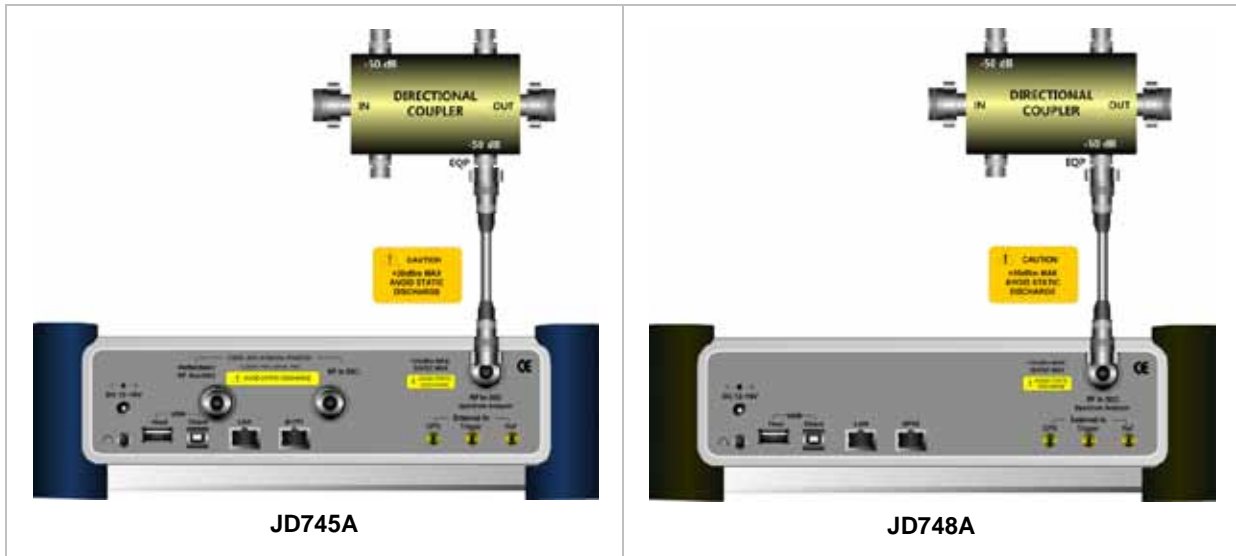

External Power Measurement

Measuring transmission power of the system can be done either directly from the instrument or with optional external power sensors. There are two kinds of external power sensors, directional or terminating power sensors and their application depends on the type of transmission power signal to be measured.

| Part No | Description | Freq. Range | Power Range |
|-------------------|--------------------------|--------------|--|
| JD731A/ JD731B | Directional Power Sensor | 300-3800 MHz | Average: +21.76 to +51.76 dBm (0.15 to 150 W) |
| | | | Peak: +36.02 to +56.02 dBm (4 to 400 W) |
| JD732A | Terminating Power Sensor | 20-3800 MHz | Average: -30 to +20 dBm |
| JD733A | Directional Power Sensor | 150-3500 MHz | Average/Peak: +20 to +47 dBm (0.1 to 50 W) |
| JD734A | Terminating Power Sensor | 20-3800 MHz | Peak: -30 to +20 dBm |
| JD736A | Terminating Power Sensor | 20-3800 MHz | Average/Peak: -30 to +20 dBm |

Types of Power Sensors

TERMINATING TYPE SENSOR CONNECTION

Connect an external power sensor to the **USB Host** port of the JD740A series and to the RF output port of BTS.

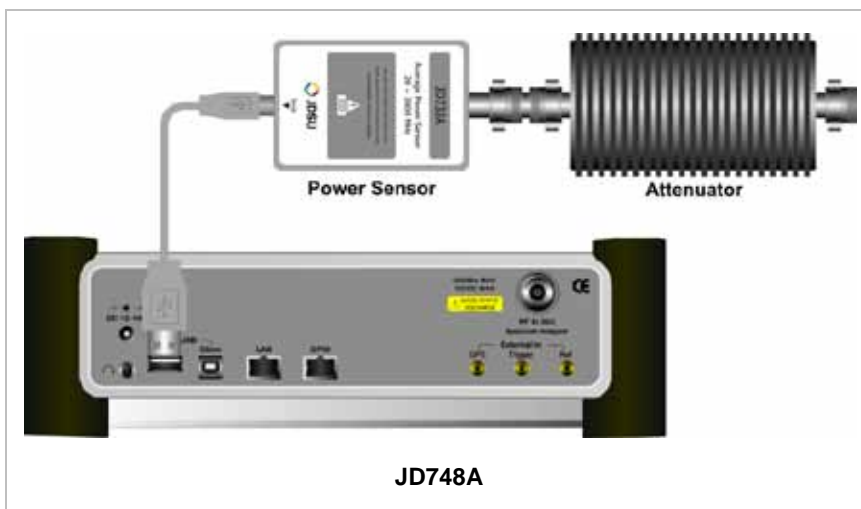
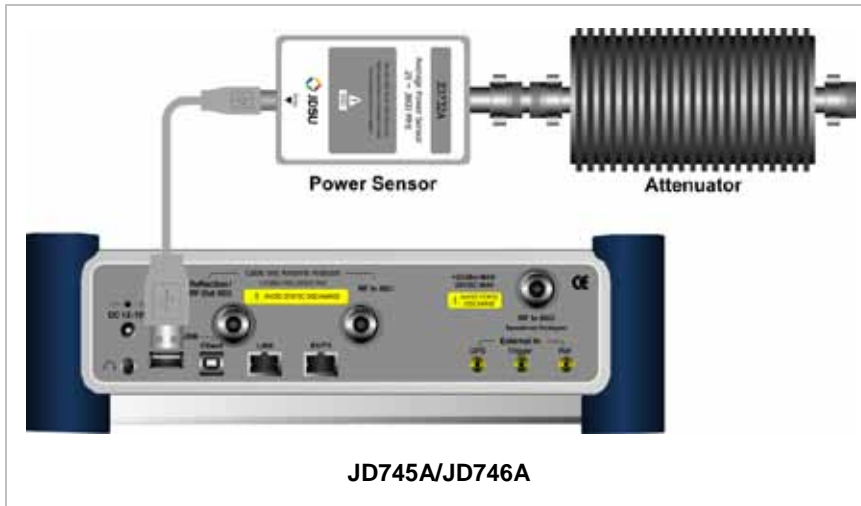

DIRECTIONAL TYPE SENSOR CONNECTION

Connect an external power sensor to the **USB Host** port of the JD740A series and to the RF output port of BTS.

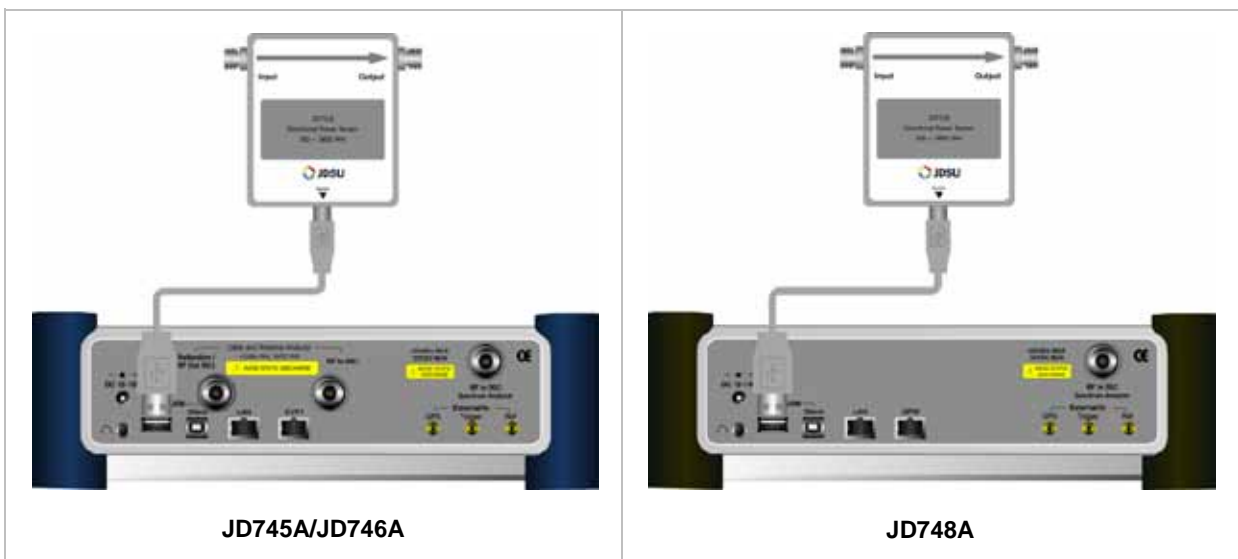

Optical Power Measurement

Connect a MP-series optical power sensor to the **USB Host** port of the JD740A series.

| Part No | Description |
|---------|---|
| MP-60 | Wavelength Range: 780 to 1650 nm Dynamic Range: 1300, 1310, 1490, 1550 nm: -50 to +10 dBm 850 nm: -45 to +10 dBm |
| MP-80 | Wavelength Range: 780 to 1650 nm Dynamic Range: 1300, 1550 nm: -35 to +23 dBm 850 nm: -30 to +23 dBm |

Optical Power Sensors



INTERNAL POWER MEASUREMENT

Setting Mode

| Step | Description |
|-----------------------------------|--|
| 1. Connect the cable | Connect a cable directly or indirectly as shown in the Connecting a Cable on page 4 of this chapter. |
| 2. Select the mode MODE | Press the MODE hard key. |

| | |
|----------------------------------|--|
| [Power Meter] | Press the Power Meter soft key. |
| [Internal RF Power Meter] | Press the Internal RF Power Meter soft key. |

Setting Frequency

| Step | Description |
|--|---|
| <p>1. Set the frequency</p> <p>FREQ/DIST</p> <p>[Unit] <Freq> or <Channel></p> <p><i>When Freq is selected:</i></p> <p>[Center Frequency] Enter a value [GHz], [MHz], [kHz], or [Hz]</p> <p>[Span] [Span], [Full Span], [Zero Span], or [Last Span] Enter a value [GHz], [MHz], [kHz], or [Hz]</p> <p>or</p> <p>[Start Frequency] Enter a value [GHz], [MHz], [kHz], or [Hz]</p> <p>[Stop Frequency] Enter a value [GHz], [MHz], [kHz], or [Hz]</p> <p><i>When Channel is selected:</i></p> <p>[Channel Standard] Select a band</p> <p>[Channel Number] Enter a value [Enter] or ENTER</p> | <p>Press the FREQ/DIST hard key.</p> <p>Press the Unit soft key. Toggle this key between Freq and Channel. A set of Freq/Dist screen menu changes accordingly.</p> <p>Press the Center Frequency soft key.</p> <p>Use the rotary knob or the arrow keys. Or use the numeric keys to input value and then press one of the unit soft keys to complete the input.</p> <p>Press the Span soft key in the Freq/Dist menu bar.</p> <p>Press one of the soft keys to select. When the Span is selected, use the rotary knob or the arrow keys to change value. Or use the numeric keys to input value and then press one of the unit soft keys to complete the input.</p> <p>Press the Start Frequency soft key.</p> <p>Use the rotary knob or the arrow keys. Or use the numeric keys to input value and then press one of the unit soft keys to complete the input.</p> <p>Press the Stop Frequency soft key.</p> <p>Use the rotary knob or the arrow keys. Or use the numeric keys to input value and then press one of the unit soft keys to complete the input.</p> <p>Press the Channel Standard soft key.</p> <p>Select a band to be measured by using the rotary knob, the arrow keys, or Page Up/Page Down soft keys. Press the Select soft key to confirm the selection.</p> <p>Press the Channel Number soft key.</p> <p>Use the numeric keys to input value and press the Enter soft key or ENTER hard key to complete the input. The instrument automatically displays its corresponding center</p> |

| | |
|---|---|
| <p>[Span] [Span], [Full Span], [Zero Span], or [Last Span] Enter a value [GHz], [MHz], [kHz], or [Hz] [Link] <FWD> or <REV></p> | <p>frequency value for the channel number. Press the Span soft key in the Freq/Dist menu bar. Press one of the soft keys to select. When the Span is selected, use the rotary knob or the arrow keys to change value. Or use the numeric keys to input value and then press one of the unit soft keys to complete the input. Press the Link soft key to set the link direction. Toggle this key between FWD and REV.</p> |
|---|---|

FREQ/DIST



There are three ways to set the frequency band: center frequency/span, start frequency/stop frequency, and channel number/span.

- n **UNIT:** Determines the way how to set the frequency band either with standard band or custom frequency band. Toggling this key between **Freq** and **Channel** changes a set of Freq/Dist screen menu automatically.

When the unit is set to Frequency:

- n **CENTER FREQUENCY:** Changes the center frequency setting in the spectrum measurement. Use the rotary knob or the arrow keys. Or use the numeric keys to input a certain value and press one of the unit soft keys to complete the input.
- n **SPAN:** Sets the frequency range over which the instrument will sweep.
- n **START FREQUENCY:** Changes the start frequency in the spectrum measurement. Use the rotary knob or the arrow keys. Or use the numeric keys to input a certain value and press one of the unit soft keys to complete the input.
- n **STOP FREQUENCY:** Changes the stop frequency in the spectrum measurement. Use the rotary knob or the arrow keys. Or use the numeric keys to input a certain value and press one of the unit soft keys to complete the input.
- n **FREQUENCY STEP:** Defines the amount of frequency to be increased or decreased when using the rotary knob or the arrow keys to change the **Center Frequency**, **Start Frequency**, or **Stop Frequency**. This frequency step size can be entered by using numeric keys and the unit soft keys.

When the unit is set to Channel:

- n **CHANNEL NUMBER:** Enters a channel number. The instrument automatically displays its corresponding center frequency value for the channel number.
- n **SPAN:** Sets the frequency range over which the instrument will sweep.
- n **CHANNEL STEP:** Defines the amount of channel to be increased or decreased when using the

rotary knob or the arrow keys to change the **Channel Number**. This channel step size can be entered by using numeric keys and the **Enter** soft key.

- n **LINK:** Sets the direction of sweeping. Toggle this key between **FWD** and **REV**.
- n **CHANNEL STANDARD:** When the channel standard is selected from the list, the center frequency information on the display screen will be mapped accordingly to the selected channel standard. The channel standards available in the instrument are listed in the Appendix C – Band, Frequency & Channel Standard.

Setting Sweep Mode



This hot key is used to set the sweep parameters. The user input window must be inactive first to get the Sweep hot key function other than the number input.

- n **SWEEP MODE:** Sets the sweep method. Toggle between **Continue** and **Single**.

| Step | Description |
|--|---|
| 1. Set the sweep mode SWEEP [Sweep Mode] | Press the SWEEP hot key. Press the Sweep Mode soft key. Toggle between Continue and Single . |

Setting Display

| Step | Description |
|--|--|
| 1. Set the measurement display AMP/SCALE [Display] <Abs> or <Rel> [Set Reference] | Press the AMP/SCALE hard key. Press the Display soft key. Toggle this soft key between Abs and Rel to select the display method. Press the Set Reference soft key to set current value as reference. This soft key is activated when the display is set to Rel . |
| [Display Max] Enter a value [dBm] or ENTER | Press the Display Max soft key to set the display maximum range. Use the numeric keys to input value. Press the unit soft key or the ENTER hard key. |
| [Display Min] | Press the Display Min soft key to set the display minimum |

| | |
|---|---|
| <p>Enter a value [dBm] or ENTER</p> <p>[External Offset] <On> or <Off></p> | <p>range Use the numeric keys to input value. Press the unit soft key or the ENTER hard key.</p> <p>Press the External Offset soft key. Enable or disable the external offset by toggling this soft key between On and Off. Use the numeric keys to input the external offset value from 0 to 60 dB and then press the dB unit soft key.</p> |
|---|---|

AMP/SCALE

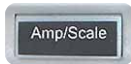

- n **DISPLAY:** Sets the display method to absolute or relative. Toggle this soft key between **Abs** and **Rel**.
- n **SET REFERENCE:** Sets current value as reference. This soft key is activated when the display is set to the **Rel**.
- n **DISPLAY MAX:** Sets the display maximum range between -100 dBm and 100 dBm.
- n **DISPLAY MIN:** Sets the display minimum range between -100 dBm and 100 dBm.
- n **EXTERNAL OFFSET:** Enables or disables the external offset. Toggle this soft key between **On** and **Off**. When it is set to **On**, enter an external offset value between 0 db and 60 dB.

Measurement Procedure

| Step | Description |
|--|--|
| <p>1. Select the measurement mode</p> <p>MODE</p> <p>[Power Meter]</p> <p>[Internal RF Power Meter]</p> | <p>Press the MODE hard key.</p> <p>Press the Power Meter soft key.</p> <p>Press the Internal RF Power Meter soft key.</p> |
| <p>2. Set the measurement parameters</p> <p>MEASURE SETUP</p> <p>[Resolution]</p> <p><0>, <1>, or <2></p> <p>[RBW]</p> <p>Enter a value</p> <p>[MHz], [kHz], or [Hz]</p> <p>[Accuracy Mode]</p> <p><Low>, <Middle>, or <High></p> | <p>Press the MEASURE SETUP hot key.</p> <p>Press the Resolution soft key to select the resolution. Each time this soft key is pressed, the selection changes.</p> <p>Press the RBW soft key.</p> <p>Use the numeric keys to enter a value.</p> <p>Press one of the unit soft keys to complete the input.</p> <p>Press the Accuracy Mode soft key to select the accuracy mode. Each time this key is pressed, selection changes among Low, Middle, and High.</p> |

| | |
|--|--|
| <p>[Average] Enter number of averaging to set</p> | <p>Press the Average soft key. Use the numeric keys and input a number between 1 and 100. When the averaging reaches to the number set here, a new measurement value replaces the earliest measurement value in sequence.</p> |
| <p>[Enter] or ENTER</p> | <p>Press the Enter soft key or the ENTER hard key.</p> |

Internal Power Measurement Procedure

MEASURE SETUP



- n **RESOLUTION:** Selects the resolution. Each time this soft key is pressed, the selection changes among **0**, **1**, and **2**.
- n **RBW:** Sets the Resolution Bandwidth (RBW) of the Spectrum Analyzer. Toggles between the **Auto** and **Manual**. When the **Auto** is selected, the RBW is selected based on the frequency span. When the **Manual** is selected, the RBW can be set from 1 Hz to 3 MHz in a 1-3 sequence using the numeric keys, the arrow keys, or the rotary knob.
- n **ACCURACY MODE:** Selects the accuracy mode. Each time this soft key is pressed, the selection changes among **Low**, **Middle**, and **High**.
- n **AVERAGE:** Sets the number of measurements to be averaged for the trace presentation. A maximum of 100 times of averaging can be set.

Setting Limit

LIMIT



This hot key is used to set the threshold value for the limit line on the display screen. It turns on or off the limit for pass/fail indication. The user input window must be inactive first to get the Limit hot key function other than the number input.

| Step | Description |
|---|---|
| <p>1. Set the limit LIMIT [Limit] <On> or <Off> [High Limit] Enter a value [dBm] or ENTER</p> | <p>Press the LIMIT hot key. Press the Limit soft key. Enable or disable the limit on the display screen by toggling this soft key between On and Off. Press the High Limit soft key to set the upper limit of the Pass/Fail indicator. Use the numeric keys to input value. Press the unit soft key or the ENTER hard key.</p> |

| | |
|--|--|
| <p>[Low Limit] Enter a value [dBm] or ENTER</p> | <p>Press the Low Limit soft key to set the lower limit of the Pass/Fail indicator. Use the numeric keys to input value. Press the unit soft key or the ENTER hard key.</p> |
|--|--|

- n **LIMIT:** Enables or disables the limit on the screen. Toggle this soft key between **On** and **Off**.
- n **HIGH LIMIT:** Sets the upper limit of the Pass/Fail indicator.
- n **LOW LIMIT:** Sets the lower limit of the Pass/Fail indicator.

Measurement Example



EXTERNAL POWER MEASUREMENT

Setting Mode

The JD740A series automatically detects and initializes the power sensor connected to the instrument. Connecting an external power sensor is mandatory for this measurement.

| Step | Description |
|---|---|
| 1. Connect the external power sensor | Connect an external power sensor as shown in the Connecting a Cable on page 5 of this chapter. |
| 2. Select the mode MODE [Power Meter] [External RF Power Meter] | Press the MODE hard key. Press the Power Meter soft key. Press the External RF Power Meter soft key. |

Setting Frequency

Setting frequency varies depending on the connected external power sensor.

| Step | Description |
|--|--|
| 1. Set the frequency FREQ/DIST [Frequency] Enter a value [GHz], [MHz], [kHz], or [Hz] | Press the FREQ/DIST hard key. Press the Frequency soft key. Use the numeric keys, the rotary knob, or the arrow keys. When using the numeric keys, the input is completed by selecting one of the unit soft keys. |

FREQ/DIST



- n **FREQUENCY:** Sets the frequency to be measured. Frequency range changes depending on the connected power sensor. Values can be entered with the numeric keys, the rotary knob, or the arrow keys. When using the numeric keys, the input is completed by selecting one of the unit soft keys including GHz, MHz, kHz, and Hz.

Setting Display

| Step | Description |
|---|--|
| 1. Set the measurement display AMP/SCALE [Display] <Abs> or <Rel> [Set Reference] | Press the AMP/SCALE hard key. Press the Display soft key. Toggle this soft key between Abs and Rel to select the display method. Press the Set Reference soft key to set current value as reference. This soft key is activated when the display is set to Rel . |

| | |
|--|---|
| <p>[Display Max] Enter a value [dBm] or ENTER</p> | <p>Press the Display Max soft key to set the display maximum range. Use the numeric keys to input value. Press the unit soft key or the ENTER hard key.</p> |
| <p>[Display Min] Enter a value [dBm] or ENTER</p> | <p>Press the Display Min soft key to set the display minimum range. Use the numeric keys to input value. Press the unit soft key or the ENTER hard key.</p> |
| <p>[External Offset] <On> or <Off></p> | <p>Press the External Offset soft key. Enable or disable the external offset by toggling this soft key between On and Off. Use the numeric keys to input the external offset value from 0 to 60 dB and then press the dB unit soft key.</p> |

AMP/SCALE 

- n **DISPLAY:** Sets the display method to absolute or relative. Toggle this soft key between **Abs** and **Rel**.
- n **SET REFERENCE:** Sets current value as reference. This soft key is activated when the display is set to the **Rel**.
- n **DISPLAY MAX:** Sets the display maximum range between -100 dBm and 100 dBm.
- n **DISPLAY MIN:** Sets the display minimum range between -100 dBm and 100 dBm.
- n **EXTERNAL OFFSET:** Enables or disables the external offset. Toggle this soft key between **On** and **Off**. When it is set to On, enter an external offset value between 0 db and 60 dB.

Measurement Procedure

| Step | Description |
|--|---|
| <p>1. Select the measurement mode MODE [Power Meter] [External RF Power Meter]</p> | <p>Press the MODE hard key. Press the Power Meter soft key. Press the External RF Power Meter soft key.</p> |
| <p>2. Set the measurement parameters MEASURE [Average Power] or [Peak Power] or [Forward Avg Power],</p> | <p>Press the MEASURE hot key. Choose either Average Power or Peak Power when JD736A is detected. Select one of the soft keys to select when JD731A, JD731B</p> |

| | |
|---|--|
| <p>[Reverse Avg Power], [Forward Peak Power], or [VSWR]</p> | <p>or JD733A is detected.</p> |
| <p>3. Set the resolution MEASURE SETUP [Resolution] <0>, <1>, or <2></p> | <p>Press the MEASURE SETUP hot key. Press the Resolution soft key to select the resolution. Each time this soft key is pressed, the selection changes.</p> |

External Power Measurement Procedure

MEASURE 

When JD736A, JD731A, JD731B or JD733A is detected, soft key menus change depending on the detected external power sensor model. *This setting shows only choice of Average Power for the power sensor JD732A and Peak Power for JD734A.*

MEASURE SETUP 

- n **RESOLUTION:** Selects the resolution. Each time this soft key is pressed, the selection changes among **0**, **1**, and **2**.

Setting Limit

LIMIT 

This hot key is used to set the threshold value for the limit line on the display screen. It turns on or off the limit for pass/fail indication. The user input window must be inactive first to get the Limit hot key function other than the number input.

| Step | Description |
|--|--|
| <p>1. Set the limit LIMIT [Limit] <On> or <Off></p> <p>[High Limit] Enter a value [dBm] or ENTER</p> <p>[Low Limit]</p> | <p>Press the LIMIT hot key. Press the Limit soft key. Enable or disable the limit on the display screen by toggling this soft key between On and Off.</p> <p>Press the High Limit soft key to set the upper limit of the Pass/Fail indicator. Use the numeric keys to input value. Press the unit soft key or the ENTER hard key.</p> <p>Press the Low Limit soft key to set the lower limit of the</p> |

| | |
|--|--|
| Enter a value [dBm] or ENTER | Pass/Fail indicator. Use the numeric keys to input value. Press the unit soft key or the ENTER hard key. |
|--|--|

- n **LIMIT:** Enables or disables the limit on the screen. Toggle this soft key between **On** and **Off**.
- n **HIGH LIMIT:** Sets the upper limit of the Pass/Fail indicator. Use the numeric keys to input value and press the unit soft key or the **ENTER** hard key to complete the input.
- n **LOW LIMIT:** Sets the lower limit of the Pass/Fail indicator. Use the numeric keys to input value and press the unit soft key or the **ENTER** hard key to complete the input.

Measurement Example



In addition to measuring and understanding trends of the system output in operation where output power constantly varies depending on the amount of calls being processed by the BTS or Repeater, the advantage of the Log graph is to easily examine the discontinuance of output power caused by the transmission problems or defective connection.

OPTICAL POWER MEASUREMENT

Setting Mode

The JD740A series automatically detects and initializes the optical power sensor connected to the instrument via a USB. Connecting an optical power sensor is mandatory for this measurement.

| Step | Description |
|---|---|
| 1. Connect the cable | Connect an optical power sensor to the USB Host as shown in the Connecting a Cable on page 7 of this chapter. |
| 2. Select the mode MODE [Power Meter] [Optical Power Meter] | Press the MODE hard key. Press the Power Meter soft key. Press the Optical Power Meter soft key. |

Setting Wavelength

| Step | Description |
|--|---|
| 1. Set the wavelength MEASURE SETUP [Wavelength] <Auto> or <Stdwave> [StdWave] [850nm], [980nm], [1300nm], [1310nm], [1480nm], [1490nm], or [1550nm] | Press the MEASURE SETUP hot key. Press the Wavelength soft key. Toggle this soft key between Auto and StdWave to select the wavelength. Press the StdWave soft key. This soft key is activated when the display is set to StdWave . Select one of the wavelengths to be measured. |

- n **WAVELENGTH:** Sets the wave length automatically or from the standard wave list. Toggle this soft key between **Auto** and **Stdwave**.
- n **STDWAVE:** Selects the standard wave length. among **850 nm, 980 nm, 1300 nm, 1310 nm, 1480 nm, 1490 nm, and 1550 nm.**

Setting Display

| Step | Description |
|---|---|
| 1. Set the measurement display AMP/SCALE [Display] <Abs> or <Rel> | Press the AMP/SCALE hard key. Press the Display soft key. Toggle this soft key between Abs and Rel to select the display method. |

| | |
|--|---|
| <p>[Set Reference]</p> | <p>Press the Set Reference soft key to set current value as reference. This key is activated when the display is set to Rel.</p> |
| <p>[Display Max] Enter a value [dBm] or ENTER</p> | <p>Press the Display Max soft key to set the display maximum range. Use the numeric keys to input value. Press the unit soft key or the ENTER hard key.</p> |
| <p>[Display Min] Enter a value [dBm] or ENTER</p> | <p>Press the Display Min soft key to set the display minimum range Use the numeric keys to input value. Press the unit soft key or the ENTER hard key.</p> |
| <p>[External Offset] <On> or <Off></p> | <p>Press the External Offset soft key. Enable or disable the external offset by toggling this soft key between On and Off. Use the numeric keys to input the external offset value from 0 to 60 dB and then press the dB unit soft key.</p> |

AMP/SCALE



- n **DISPLAY:** Sets the display method to absolute or relative. Toggle this soft key between **Abs** and **Rel**.
- n **SET REFERENCE:** Sets current value as reference. This soft key is activated when the display is set to the **Rel**.
- n **DISPLAY MAX:** Sets the display maximum range between -100 dBm and 100 dBm.
- n **DISPLAY MIN:** Sets the display minimum range between -100 dBm and 100 dBm.
- n **EXTERNAL OFFSET:** Enables or disables the external offset. Toggle this soft key between **On** and **Off**. When it is set to On, enter an external offset value between 0 db and 60 dB.

Measurement Procedure

| Step | Description |
|---|--|
| <p>1. Select the measurement mode MODE [Power Meter] [Optical Power Meter]</p> | <p>Press the MODE hard key. Press the Power Meter soft key. Press the Optical Power Meter soft key.</p> |
| <p>2. Set the measurement parameters MEASURE SETUP [Resolution] <0>, <1>, or <2></p> | <p>Press the MEASURE SETUP hot key. Press the Resolution soft key to select the resolution. Each time this soft key is pressed, the selection changes.</p> |

Optical Power Measurement Procedure

MEASURE SETUP



- n **RESOLUTION:** Selects the resolution. Each time this soft key is pressed, the selection changes among **0**, **1**, and **2**.

Setting Limit

LIMIT



This hot key is used to set the threshold value for the limit line on the display screen. It turns on or off the limit for pass/fail indication. The user input window must be inactive first to get the Limit hot key function other than the number input.

| Step | Description |
|---|--|
| 1. Set the limit LIMIT [Limit] <On> or <Off> [High Limit] Enter a value [dBm] or ENTER [Low Limit] Enter a value [dBm] or ENTER | Press the LIMIT hot key. Press the Limit soft key. Enable or disable the limit on the display screen by toggling this soft key between On and Off . Press the High Limit soft key to set the upper limit of the Pass/Fail indicator. Use the numeric keys to input value. Press the unit soft key or the ENTER hard key. Press the Low Limit soft key to set the lower limit of the Pass/Fail indicator. Use the numeric keys to input value. Press the unit soft key or the ENTER hard key. |

- n **LIMIT:** Enables or disables the limit on the screen. Toggle this soft key between **On** and **Off**.
- n **HIGH LIMIT:** Sets the upper limit of the Pass/Fail indicator. Use the numeric keys to input value and press the unit soft key or the **ENTER** hard key to complete the input.
- n **LOW LIMIT:** Sets the lower limit of the Pass/Fail indicator. Use the numeric keys to input value and press the unit soft key or the **ENTER** hard key to complete the input.

Measurement Example

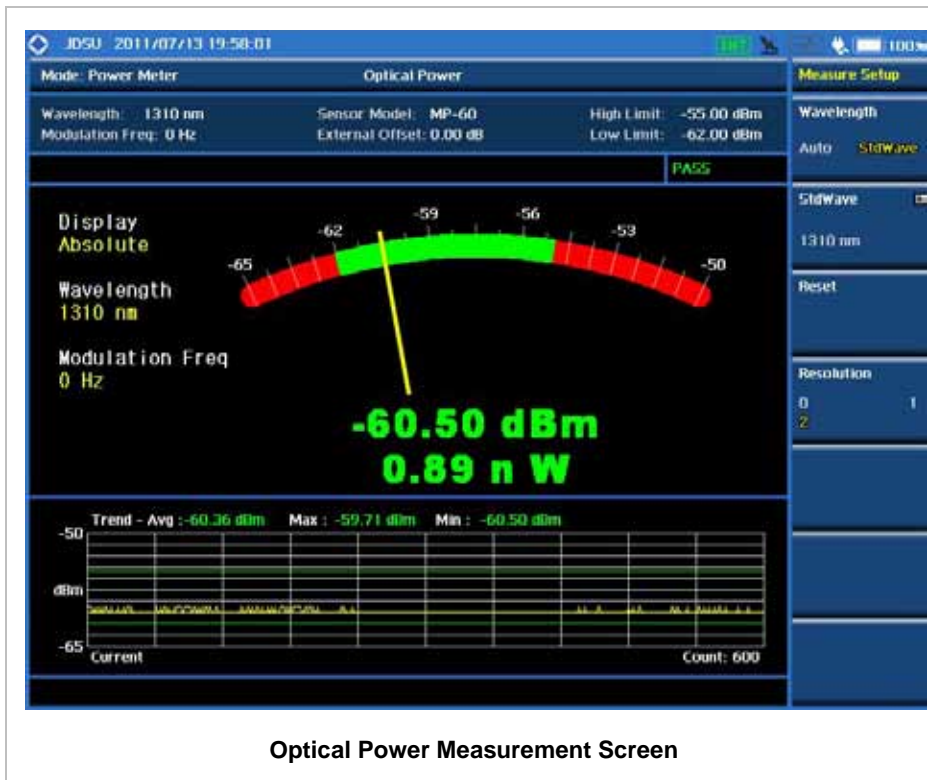

Optical Power Measurement Screen

E1 Analyzer

This E1 Analyzer function is optional that the JD745A Base Station Analyzer offers as the Option 002. It provides simple solution for E1 testing needs from basic transmission monitoring to BERT testing to determine that a problem relates to wire lines or the wireless side.

In this Chapter

| | |
|-------------------------------|----|
| Using E1 Analyzer | 2 |
| Display Overview | 3 |
| Connection Diagram | 4 |
| Out-of-service Testing | 4 |
| In-service Monitoring | 5 |
| Transmission Monitoring | 5 |
| Measurement Procedure | 5 |
| Measurement Example | 7 |
| BERT Testing | 7 |
| Measurement Procedure | 7 |
| Measurement Example | 10 |

(Rev. 6.0)

USING E1 ANALYZER

The European Conference of Postal and Telecommunications Administrations (CEPT) originally standardized the E-carrier system, which revised and improved the earlier American T-carrier technology, and this has now been adopted by the International Telecommunication Union Telecommunication Standardization Sector (ITU-T).

Physically E1 is transmitted as 32 timeslots, but one is used for framing and typically one allocated for signaling call setup and tear down. Unlike Internet data services, E-carrier systems permanently allocate capacity for a voice call for its entire duration. This ensures high call quality because the transmission arrives with the same short delay (Latency) and capacity at all times.

This portable test instrument can be a useful tool to check the overall health of the transmission system and assist in locating the source of problems or defects.

The E1 Analyzer function provides following measurements.

- n Monitoring
- n BERT Testing (PCM31 Only)
 - Y Terminate Mode: The Terminate mode is used when you wish to send and receive an E1 signal. The instrument terminates the received signal with a low impedance termination, and requires that the circuit be disrupted for testing.
 - Y Bridge Mode: The Bridge mode is similar to the Monitor mode. However, in the Bridge mode, the instrument applies high impedance isolation resistors to the circuit under test. This isolation circuitry will protect the signal from any possible disruption. There is no need to plug into the TX jack of the test set while in the BRIDGE mode, and there is no need to specify a test pattern to be transmitted. However, the transmitter in the test set is sending the selected test pattern, framing, coding, and CRC.
 - Y Monitor Mode: The Monitor (protected monitoring point) mode is used when a monitor access is to be made. The network element has isolated the MON signal from the live signal with high impedance resistors. It is useful that it protects the live signal from any possible disruptions caused by the testing process.

DISPLAY OVERVIEW



E1 Analyzer Screen

Measurement Mode Information: E1 Analyzer

E1 Analyzer Information: This window shows Event Logging status, Test Start Time and Elapsed Time.

E1 Measurement Setting Information

- Rx Mode: Current test modes setting information, Terminate, Bridge and Monitor
- Framing: Framing modes setting information, PCM31
- Line Code: Two different line coding formats are used in E1 networks, AMI and HDB3
- Tx Clock: Tx Clock setting information, Internal and Rx
- Tx Pattern: Selected Tx Pattern information
1-8, 1-16, All 1's, All 0's, and Alternate
- Tx LBO: Line Build Out level setting information, 0dB and -6dB
- CRC-4: Status for the CRC-4 in BERT testing

Screen Menu Title

Screen Menu and Sub-menu

System Information

- Date and Time
- Frequency Reference Indicator: INT for internal and EXT for external. The EXT icon is green when an external reference is locked or red when the external reference is not locked.
- USB Indicator
- DC Input Power Indicator
- Battery Indicator

CONNECTION DIAGRAM

Out-of-service Testing

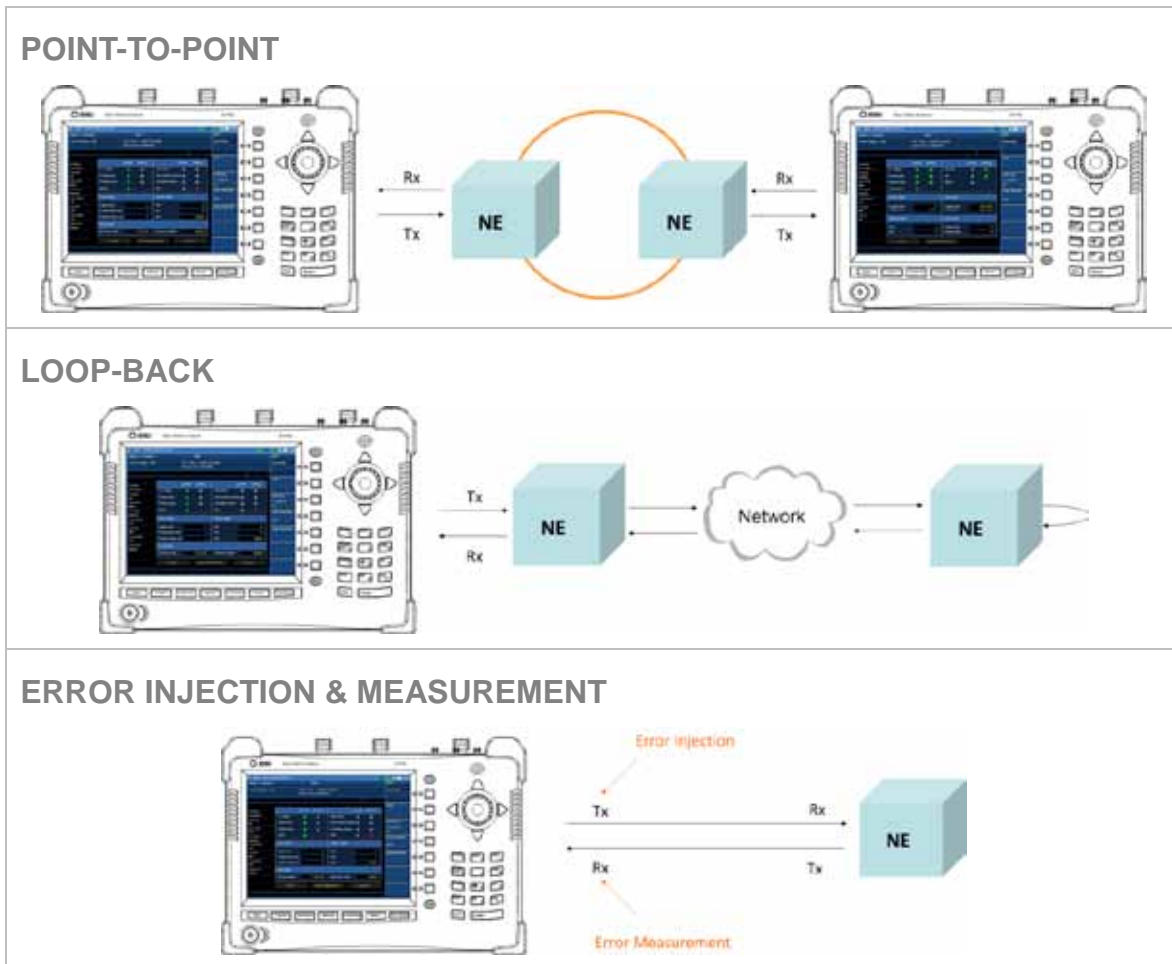

In-service Monitoring

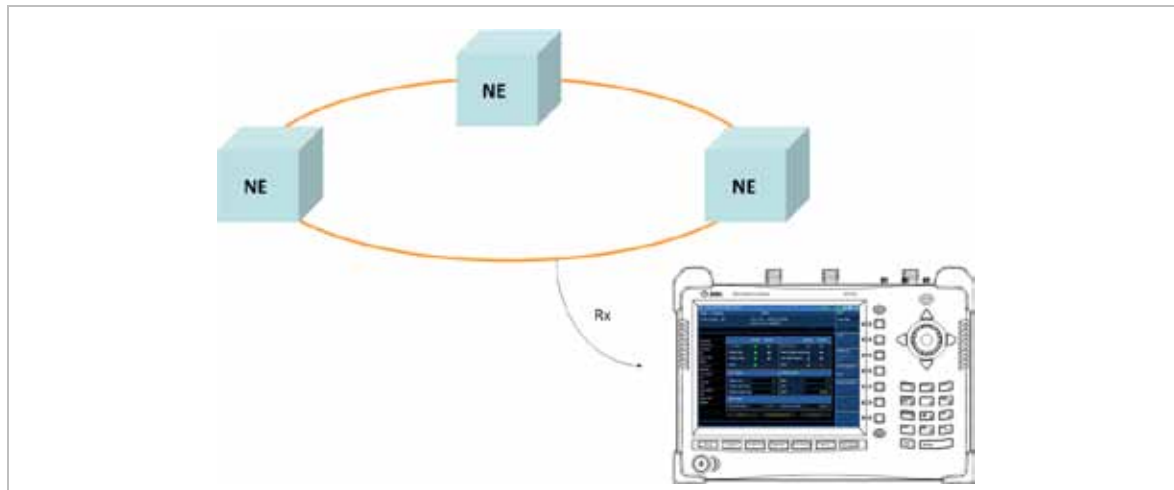

TRANSMISSION MONITORING

Measurement Procedure

The following is the basic settings and procedure of transmission monitoring for E1 analysis.

| Step | Description |
|--|--|
| 1. Set the mode MODE [E1/T1 Analyzer] [E1 Analyzer] [Monitoring] | Press the MODE hard key. Press the E1/T1 Analyzer soft key. Press the E1 Analyzer soft key. Press the Monitoring soft key. |
| 2. Set the measurement parameters MEASURE SETUP [RX Mode] [Terminate], [Bridge], or [Monitor] [Framing] <PCM30> or <PCM31> [Line Code] <AMI> or <HDB3> | Press the MEASURE SETUP hot key. Press the RX Mode soft key. Press one of the mode soft keys to select. Press the Framing soft key to toggle between PCM30 and PCM31 and select the framing type. Press the Line Code soft key to toggle between AMI and HDB3 and select line code type. |

| | |
|---|---|
| <p>3. Set the monitoring parameters</p> <p>MEASURE</p> <p>[Monitoring]</p> <p>[Event Log]</p> <p><On> or <Off></p> <p>[Start/Stop]</p> | <p>Press the MEASURE hot key.</p> <p>Press the Monitoring soft key.</p> <p>Press the Event Log soft key to toggle between On and Off and select one.</p> <p>Press the Start/Stop soft key to start or stop monitoring.</p> |
|---|---|

E1 Transmission Monitoring Analysis Procedure

MEASURE SETUP



- n **RX MODE:** Selects the receiver inputs.
 - Y **TERMINATE:** The transmitter sends data according to the transmitter settings in the **Measure Setup** menu including framing and line code. Terminate mode provides a nominal 120-ohm input impedance.
 - Y **BRIDGE:** Provides input impedance greater than 1 k ohms for in-service monitoring, bridging the receiver input across lines that are terminated elsewhere in the network.
 - Y **MONITOR:** Is designed for in-service monitoring of E1 lines. In this monitor mode, the instrument is set for 120-ohm nominal input impedance.
- n **FRAMING:** Selects the types of framing. If the framing type of received signal is not accord with receiver setting, framing alarm occurs.
 - Y **PCM30:** Timeslots from 1 to 15 correspond to channels from 1 to 15 and timeslots from 17 to 31 correspond to channels from 16 to 30. Timeslot 16 is used for the multi-frame alignment and Channel Associated Signaling (CAS).

NOTE: Bit Error is not supported for PCM30 framing type.
 - Y **PCM31:** Timeslots from 1 to 31 correspond to channels from 1 to 31.
- n **LINE CODE:** Selects the types of line codes to send E1 signal.
 - Y **AMI:** It stands for Alternate Mark Inversion. A line code uses one three level signal to convey binary digits in which successive binary ones (“marks” or pulses) are of alternating polarity, either positive or negative, equal in amplitude. A binary zero (“space”) is transmitted as no pulse or zero amplitude.
 - Y **HDB3:** It stands for High Density Bipolar Order 3 encoding. It is a bipolar signaling technique (using both positive and negative pulses) based on the AMI. It extends AMI by inserting violation codes whenever there is a run of 4 or more zeros.

MEASURE



- n **MONITORING:** Sets the measurement parameters for monitoring.
 - Y **START/STOP:** Starts or stops the transmission monitoring.
 - Y **EVENT LOG:** Enables or disables event logging of E1 Analyzer. When the Event Log is set to on, the user can save the file name for the logging.
- n **BERT:** Sets the measurement parameters for BER testing. Refer to the following section of BERT Testing for more information.

Measurement Example

The screenshot displays the E1 Transmission Monitoring interface. At the top, it shows the mode as 'E1 Analyzer' and 'Monitoring'. The event logging is currently 'Off', and the start time is '12/06 23:38:37' with an elapsed time of '00:00:02'. The interface is divided into several sections:

- Configuration List (Left):** Includes Rx Mode (Terminate), Framing (PCM30), Line Code (AMI), TX Clock (Internal), TX Pattern (I-4), TX LBO (DdB), and CBC-4 (Off).
- Monitoring Table (Center):**

| | Current | History | | Current | History |
|--------------|---------|---------|---------|---------|---------|
| E1 Signal | ● | ● | FAS RAI | ● | ● |
| Frame Sync | ● | ● | AIS | ● | ● |
| Pattern Sync | ● | ● | HDB3 | ● | ● |
| Code Sync | ● | ● | | | |
- Error Count and Rate (Center-Right):**

| Error Count | | Error Rate | |
|-------------|---|-------------|-----------|
| Frame Error | 0 | Frame Error | [0.0e+00] |
| Code Error | 0 | Code Error | [0.0e+00] |
- Alarm and Loss Counts (Bottom-Center):**

| Alarm Count | | Loss Count | |
|-------------|---|--------------|---|
| FAS | 0 | Frame Sync | 0 |
| AIS | 0 | Pattern Sync | 0 |
- Control Buttons (Bottom):** 'Tx On' and 'Error Injection Off'.
- Right Panel:** Includes 'Monitor', 'Start/Stop', 'Clear', 'Event Log' (set to 'Off'), and 'E1_log.csv'.

E1 Transmission Monitoring Screen

BERT TESTING

Measurement Procedure

The following is the basic settings and procedure of BERT testing for E1 analysis.

| Step | Description |
|---|--|
| <p>1. Set the mode</p> <p>MODE</p> <p> [E1/T1 Analyzer]</p> <p> [E1 Analyzer]</p> <p> [BERT]</p> | <p>Press the MODE hard key.</p> <p>Press the E1/T1 Analyzer soft key.</p> <p>Press the E1 Analyzer soft key.</p> <p>Press the BERT soft key.</p> |
| <p>2. Set the measurement parameters</p> <p>MEASURE SETUP</p> <p> [RX Mode]</p> <p> [Terminate], [Bridge], or [Monitor]</p> <p> [Framing]</p> <p> <PCM30> or <PCM31></p> <p> [Line Code]</p> <p> <AMI> or <HDB3></p> <p> [Pattern]</p> <p> [1-8], [1-16], [All 1's], [All 0's], or</p> <p> [Alternate]</p> <p> [TX Clock]</p> <p> <Internal> or <RX></p> <p> [TX LBO]</p> <p> <0dB> or <-6dB></p> <p> [CRC-4]</p> <p> <On> or <Off></p> | <p>Press the MEASURE SETUP hot key.</p> <p>Press the RX Mode soft key.</p> <p>Press one of the mode soft keys to select.</p> <p>Press the Framing soft key to toggle between PCM30 and PCM31 and select the framing type.</p> <p>Press the Line Code soft key to toggle between AMI and HDB3 and select the line code type.</p> <p>Press the Pattern soft key.</p> <p>Press one of the stress pattern soft keys to select.</p> <p>Press the TX Clock soft key to toggle between Internal and RX and select the timing source.</p> <p>Press the TX LBO soft key to toggle between 0dB and -6dB and select the Tx line build out level.</p> <p>Press the CRC-4 soft key to toggle between On and Off and select one.</p> |
| <p>3. Set the monitoring parameters</p> <p>MEASURE</p> <p> [BERT]</p> <p> [Event Log]</p> <p> <On> or <Off></p> <p> [Error Injection]</p> <p> [None], [1E-3], [1E-4], [1E-5], or</p> <p> [Single]</p> <p> [Start/Stop]</p> | <p>Press the MEASURE hot key.</p> <p>Press the BERT soft key.</p> <p>Press the Event Log soft key to toggle between On and Off and select one.</p> <p>Press the Error Injection soft key.</p> <p>Press one of the error injection type soft keys to select.</p> <p>Press the Start/Stop soft key to start or stop testing.</p> |

E1 BERT Testing Procedure

MEASURE SETUP



- n **RX MODE:** Selects the receiver inputs.
 - Y **TERMINATE:** The transmitter sends data according to the transmitter settings in the **Measure Setup** menu including framing, line code, and BERT patterns. Terminate mode provides a nominal 120-ohm input impedance.
 - Y **BRIDGE:** Provides input impedance greater than 1 k ohms for in-service monitoring, bridging the receiver input across lines that are terminated elsewhere in the network.
 - Y **MONITOR:** Is designed for in-service monitoring of E1 lines. In this monitor mode, the instrument is set for 120-ohm nominal input impedance.
- n **FRAMING:** Selects the types of framing. If the framing type of received signal is not accord with receiver setting, framing alarm occurs.
 - Y **PCM30:** Timeslots from 1 to 15 correspond to channels from 1 to 15 and timeslots from 17 to 31 correspond to channels from 16 to 30. Timeslot 16 is used for the multi-frame alignment and Channel Associated Signaling (CAS).
 - NOTE:** Bit Error is not supported for PCM30 framing type.
 - Y **PCM31:** Timeslots from 1 to 31 correspond to channels from 1 to 31.
- n **LINE CODE:** Selects the types of line codes to send E1 signal.
 - Y **AMI:** It stands for Alternate Mark Inversion. A line code uses one three level signal to convey binary digits in which successive binary ones ("marks" or pulses) are of alternating polarity, either positive or negative, equal in amplitude. A binary zero ("space") is transmitted as no pulse or zero amplitude.
 - Y **HDB3:** It stands for High Density Bipolar Order 3 encoding. It is a bipolar signaling technique (using both positive and negative pulses) based on the AMI. It extends AMI by inserting violation codes whenever there is a run of 4 or more zeros.
- n **PATTERN:** Selects the types of stress patterns.
 - Y **1-8:** An eight-bit pattern that contains a single one. Used to test clock recovery.
 - Y **1-16:** A sixteen-bit pattern that contains a single one. Used to test clock recovery.
 - Y **ALL 1'S:** A pattern that causes line drivers to consume the maximum power.
 - Y **ALL 0'S:** A pattern that is often selected to verify HDB3 provisioning. Circuit will drop if optioned for AMI.
 - Y **ALTERNATE:** A pattern that alternates between ones and zeroes.
- n **TX CLOCK:** Selects the clock source to measure frequency and timing.
 - Y **INTERNAL:** Internal clock uses an internal oscillator in case of external reference is not

available and the instrument does not transmit signal to synchronized equipment. The instrument provides the clock to the unit under test and most cases in Loopback test mode.

- Y **RX:** Transmit clock uses the frequency recovered from the received signal (Network Loop), if accurate frequency measurement is required.
- n **TX LBO:** It stands for Transmit Line Build Out. Selects the line build out level. Possible values for LBO are 0 dB and -6 dB.
- n **CRC-4:** Activates and deactivates CRC-4. It is used to detect errors in blocks of data transmitted across communication links. The detection is determined by a formula applied at both ends of transmit and receive. E1 uses a 4 bit CRC (CRC-4) for error checking.



MEASURE

- n **MONITORING:** Sets the measurement parameters for monitoring.
- n **BERT:** Sets the measurement parameters for BER testing.
- Y **START/STOP:** Starts or stops the testing.
- Y **EVENT LOG:** Enables or disables event logging of E1 Analyzer. When the Event Log is set to on, the user can save the file name for the logging.
- Y **ERROR INJECTION:** Sets an error injection type among None, 1E-3, 1E-4, 1E-5, and Single.

Measurement Example

The screenshot shows the E1 BERT Testing Screen with the following data:

| Rx Mode | Current | History | Current | History |
|--------------|---------|---------|---------|---------|
| E1 Signal | ● | ● | FAS RAI | ● |
| Frame Sync | ● | ● | AIS | ● |
| Pattern Sync | ● | ● | HDB3 | ● |
| Code Sync | ● | | | |

| Error Count | Error Rate |
|------------------|------------------------|
| Frame Error: 0 | Frame Error: [2.2e-07] |
| Code Error: 8191 | Code Error: [2.2e-04] |

| Alarm Count | Loss Count |
|-------------|-----------------|
| FAS: 0 | Frame Sync: 0 |
| AIS: 0 | Pattern Sync: 0 |

Buttons: Tx On, Error Injection Off

E1 BERT Testing Screen

T1 Analyzer

This T1 Analyzer function is optional that the JD745A Base Station Analyzer offers as the Option 003. It provides simple solution for T1 testing needs from basic transmission monitoring to BERT testing to determine that a problem relates to wire lines or the wireless side.

In this Chapter

| | |
|-------------------------------|----|
| Using T1 Analyzer | 2 |
| Display Overview..... | 2 |
| Connection Diagram..... | 4 |
| Out-of-service Testing | 4 |
| In-service Monitoring..... | 4 |
| Transmission Monitoring | 5 |
| Measurement Procedure | 5 |
| Measurement Example | 6 |
| RX Signal Level | 7 |
| Measurement Procedure | 7 |
| Measurement Example | 9 |
| BERT Testing..... | 9 |
| Measurement Procedure | 9 |
| Measurement Example | 12 |
| Loop Testing | 13 |
| Measurement Procedure | 13 |
| Measurement Example | 17 |

(Rev. 6.0)

USING T1 ANALYZER

The T1 is what telephone companies have traditionally used to transport digitized telephone conversations between central offices. As early as the 1960's, a single T1 circuit made it possible for a telephone company to deliver 24 high quality voice conversations. T1 is a fully digitalized service with no possibility of crosstalk, which is common in analog carrier networks where copper pairs pickup emissions from neighboring pairs. Significant increases in noise immunity were also achieved by adopting this new digital transmission standard.

Since the early 1980's, T1 service has been available to private industry throughout the country. This document will discuss the various types of T1 measurement items, how to measure them, and understand the general guidelines of T1 analysis using the JD745A Base Station Analyzer.

This portable test instrument can be a useful tool to check the overall health of the transmission system and assist in locating the source of problems or defects. The T1 Analyzer function provides following measurements.

- n Monitoring
- n RX Signal Level
- n BERT Testing
- n Loop Testing

DISPLAY OVERVIEW

Measurement Mode Information: T1 Analyzer

T1 Analyzer Information: This window shows Event Logging status, Test Start Time and Elapsed Time.

T1 Measurement Setting Information

- Rx Mode: Current test modes setting information, Terminate, Bridge and Monitor
- Framing: Framing modes setting information, PCM-31
- Line Code: Two different line coding formats are used in T1 networks, AMI and B8ZS
- Tx Clock: Tx Clock setting information, Internal and Rx
- Tx Pattern: Selected Tx Patter information
Off, 1-8, 1-16, All 1's, All 0's, Alternate, 3-24, QRSS, 2e23, 2e15, 2e23 INV, 2e15 INV

- Tx LBO: Line Build Out level setting information, 0dB, -7.5dB, and -15dB
- Loop Mode: Current loop modes information, CSU and NIU
- Loop Link: Current selection of Link, Inband or Datalink

Screen Menu Title

Screen Menu and Sub-menu, T1 Analyzer supports following measurements.

- Monitoring
- Rx Signal
- BERT
- Loop Test

System Information

- Date and Time
- Frequency Reference Indicator: INT for internal and EXT for external. The EXT icon is green when an external reference is locked or red when the external reference is not locked.
- USB Indicator
- DC Input Power Indicator
- Battery Indicator



T1 Analyzer Screen

CONNECTION DIAGRAM

Out-of-service Testing

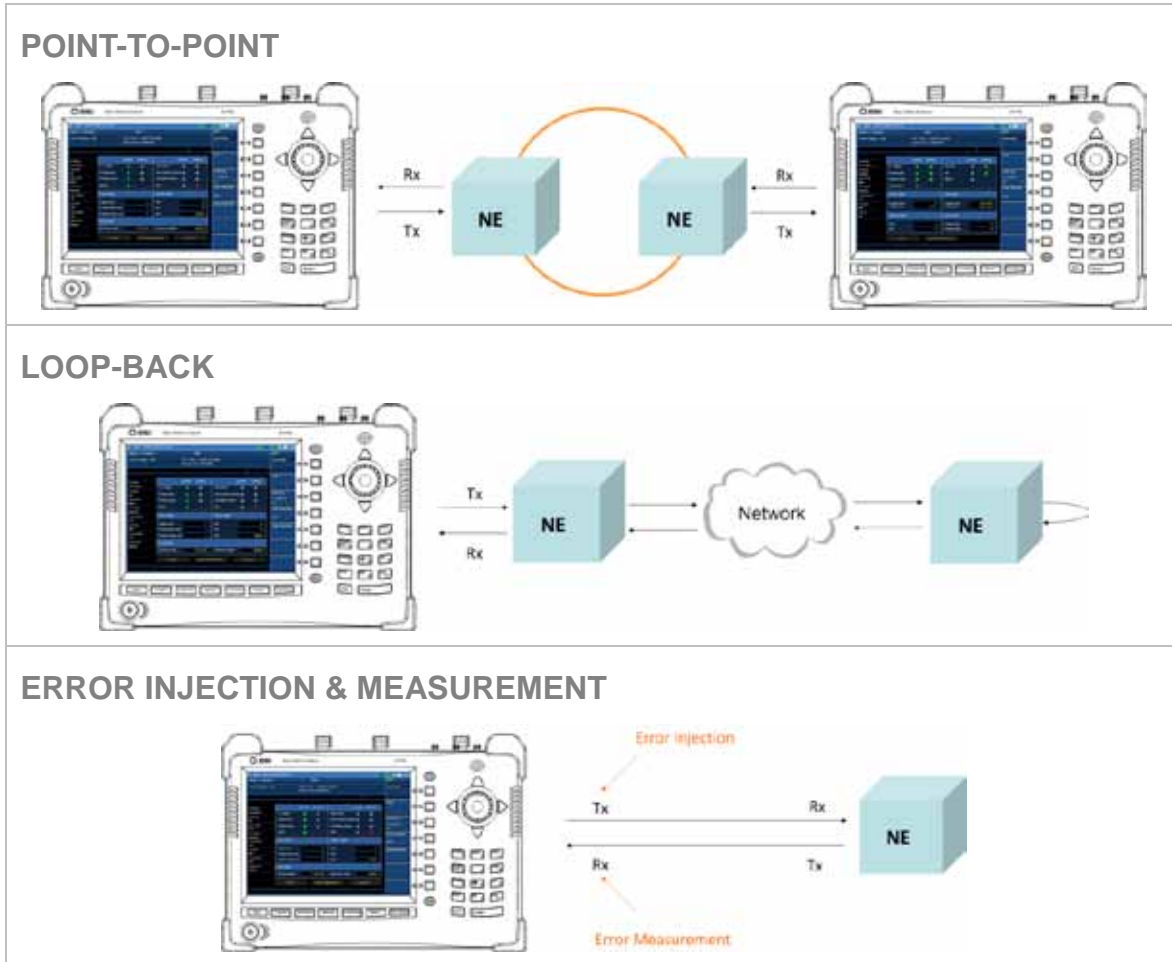

In-service Monitoring

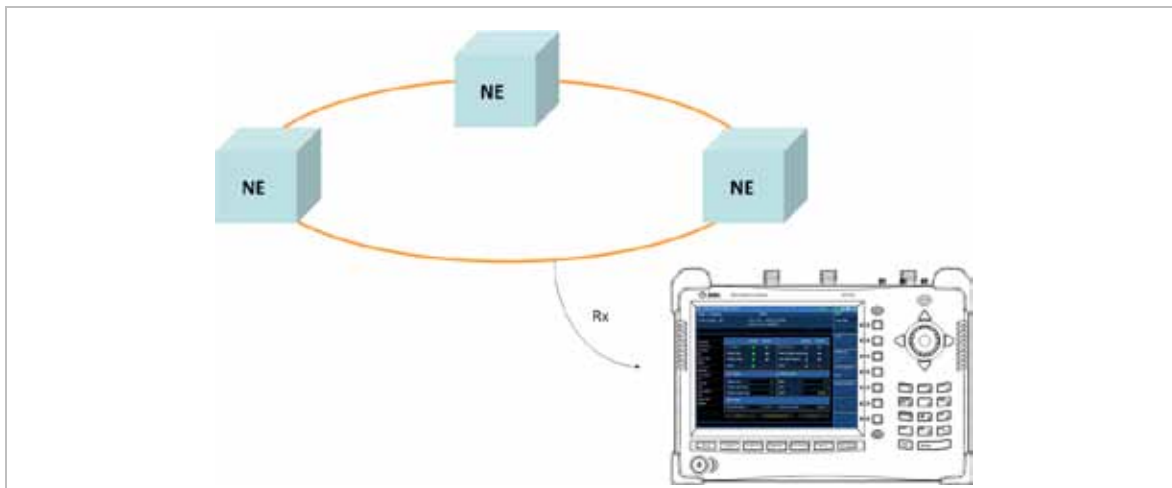

TRANSMISSION MONITORING

Measurement Procedure

| Step | Description |
|--|--|
| 1. Set the mode MODE [E1/T1 Analyzer] [T1 Analyzer] [Monitoring] | Press the MODE hard key. Press the E1/T1 Analyzer soft key. Press the T1 Analyzer soft key. Press the Monitoring soft key. |
| 2. Set the measurement parameters MEASURE SETUP [RX Mode] [Terminate], [Bridge], or [Monitor] [Framing] <SF-D4> or <ESF> [Line Code] <AMI> or <B8ZS> | Press the MEASURE SETUP hot key. Press the RX Mode soft key. Press one of the soft keys to select the receiver input. Press the Framing soft key to toggle between SF-D4 and ESF and select the framing type. Press the Line Code soft key to toggle between AMI and B8ZS and select line code type. |
| 3. Set the test parameters MEASURE [Monitoring] [Event Log] <On> or <Off> [Start/Stop] | Press the MEASURE hot key. Press the Monitoring soft key. Press the Event Log soft key to toggle between On and Off and select the event log option. Press the Start/Stop soft key to start or stop monitoring. |

T1 Transmission Monitoring Analysis Procedure

MEASURE SETUP



- n **RX MODE:** Selects the receiver inputs.
- Y **TERMINATE:** The transmitter sends data according to the transmitter settings in the Measure Setup menu, including framing, line code, and BER patterns. Terminate mode provides a nominal 100 ohm input impedance.
- Y **BRIDGE:** Provides input impedance greater than 1k ohm for in-service monitoring, bridging the receiver input across lines that are terminated elsewhere in the network.

- Y **MONITOR:** The monitor mode is designed for in-service monitoring of T1 lines. In monitor mode, the instrument is set to 100 ohm nominal input impedance.
- n **FRAMING:** Selects the types of framing. If the framing type of received signal is not accord with receiver setting, framing alarm occurs.
 - Y **SF-D4 (SUPER FRAME-D4):** Group of 12 frames, used to align equipment for framing.
 - Y **ESF (EXTENDED SUPER FRAME):** Group of 24 frames, used to align equipment for framing, Uses 4K for a maintenance channel (Facilities Data Link), 2K for CRC-6 checksum and 2K for framing/synchronization.
- n **LINE CODE:** Selects the types of line codes to send T1 signal.
 - Y **AMI:** It stands for Alternate Mark Inversion. A line code uses one three level signal to convey binary digits in which successive binary ones ("marks" or pulses) are of alternating polarity, either positive or negative, equal in amplitude. A binary zero ("space") is transmitted as no pulse or zero amplitude.
 - Y **B8ZS:** It stands for Bipolar with 8-Zero Substitution. A coding scheme in which the transmitter "substitutes" a fixed pattern of ones, zeros, and BPVs in place of 8 consecutive zeros.

MEASURE



- n **MONITORING:** Sets parameters for transmission monitoring.
 - Y **START/STOP:** Starts or stops the testing.
 - Y **EVENT LOG:** Enables or disables automatic event logging of T1 Analyzer. When the Event Log is set to on, the user can save the file name for the logging.

Measurement Example



T1 Transmission Monitoring Screen

RX SIGNAL LEVEL

Measurement Procedure

| Step | Description |
|---|---|
| 1. Set the mode MODE [E1/T1 Analyzer] [T1 Analyzer] [RX Signal] | Press the MODE hard key. Press the E1/T1 Analyzer soft key. Press the T1 Analyzer soft key. Press the RX Signal soft key. |
| 2. Set the measurement parameters MEASURE SETUP [RX Mode] [Terminate], [Bridge], or [Monitor] [Framing] <SF-D4> or <ESF> [Line Code] | Press the MEASURE SETUP hot key. Press the RX Mode soft key. Press one of the soft keys to select the receiver input. Press the Framing soft key to toggle between SF-D4 and ESF and select the framing type. Press the Line Code soft key to toggle between AMI |

| | |
|--|--|
| <AMI> or <B8ZS> | and B8ZS and select line code type. |
| <p>3. Set the test parameters</p> <p>MEASURE</p> <p>[RX Signal]</p> <p>[Event Log]</p> <p><On> or <Off></p> <p>[Start/Stop]</p> | <p>Press the MEASURE hot key.</p> <p>Press the RX Signal soft key.</p> <p>Press the Event Log soft key to toggle between On and Off and select the event log option.</p> <p>Press the Start/Stop soft key to start or stop the test.</p> |

T1 RX Signal Level Analysis Procedure

MEASURE SETUP



- n **RX MODE:** Selects the receiver inputs.
 - Y **TERMINATE:** The transmitter sends data according to the transmitter settings in the Measure Setup menu, including framing, line code, and BER patterns. Terminate mode provides a nominal 100 ohm input impedance.
 - Y **BRIDGE:** Provides input impedance greater than 1k ohm for in-service monitoring, bridging the receiver input across lines that are terminated elsewhere in the network.
 - Y **MONITOR:** The monitor mode is designed for in-service monitoring of T1 lines. In monitor mode, the instrument is set to 100 ohm nominal input impedance.
- n **FRAMING:** Selects the types of framing. If the framing type of received signal is not accord with receiver setting, framing alarm occurs.
 - Y **SF-D4 (SUPER FRAME-D4):** Group of 12 frames, used to align equipment for framing.
 - Y **ESF (EXTENDED SUPER FRAME):** Group of 24 frames, used to align equipment for framing, Uses 4K for a maintenance channel (Facilities Data Link), 2K for CRC-6 checksum and 2K for framing/synchronization.
- n **LINE CODE:** Selects the types of line codes to send T1 signal.
 - Y **AMI:** It stands for Alternate Mark Inversion. A line code uses one three level signal to convey binary digits in which successive binary ones (“marks” or pulses) are of alternating polarity, either positive or negative, equal in amplitude. A binary zero (“space”) is transmitted as no pulse or zero amplitude.
 - Y **B8ZS:** It stands for Bipolar with 8-Zero Substitution. A coding scheme in which the transmitter "substitutes" a fixed pattern of ones, zeros, and BPVs in place of 8 consecutive zeros.

MEASURE



- n **RX SIGNAL:** Sets parameters for RX signal level.
- Y **START/STOP:** Starts or stops the testing.
- Y **EVENT LOG:** Enables or disables automatic event logging of T1 Analyzer. When the Event Log is set to on, the user can save the file name for the logging.

Measurement Example



T1 RX Signal Level Measurement Screen

BERT TESTING

Measurement Procedure

| Step | Description |
|---|---|
| 1. Set the mode MODE [E1/T1 Analyzer] [T1 Analyzer] [BERT] | Press the MODE hard key. Press the E1/T1 Analyzer soft key. Press the T1 Analyzer soft key. Press the BERT soft key. |

| | |
|--|---|
| <p>2. Set the measurement parameters</p> <p>MEASURE SETUP</p> <p>[RX Mode] [Terminate], [Bridge], or [Monitor]</p> <p>[Framing] <SF-D4> or <ESF></p> <p>[Line Code] <AMI> or <B8ZS></p> <p>[Pattern] [1-8], [1-16], [All 1's], [All 0's], [Alternate], [3-24], [QRSS], [2e23], [2e15], [2e23 INV], or [2e15 INV]</p> <p>[TX Clock] <Internal> or <RX></p> <p>[TX LBO] <0dB>, <-7.5dB>, or <-15dB></p> | <p>Press the MEASURE SETUP hot key.</p> <p>Press the RX Mode soft key.</p> <p>Press one of soft keys to select the receiver input.</p> <p>Press the Framing soft key to toggle between SF-D4 and ESF and select the framing type.</p> <p>Press the Line Code soft key to toggle between AMI and B8ZS and select line code type.</p> <p>Press the Pattern soft key.</p> <p>Press one of the soft keys to select stress pattern.</p> <p>Press the TX Clock soft key to toggle between Internal and RX and select the timing source.</p> <p>Press the TX LBO soft key. Toggle between 0dB, -7.5dB and -15dB to select the TX line build out level.</p> |
| <p>3. Set the test parameters</p> <p>MEASURE</p> <p>[BERT] [Event Log] <On> or <Off></p> <p>[Error Injection] [None], [1E-3], [1E-4], [1E-5], or [Single]</p> <p>[Alarm Injection] [AIS Alarm] <On> or <Off> [RAI Alarm] <On> or <Off></p> <p>[Start/Stop]</p> | <p>Press the MEASURE hot key.</p> <p>Press the BERT soft key.</p> <p>Press the Event Log soft key to toggle between On and Off and select the event log option.</p> <p>Press the Error Injection soft key.</p> <p>Press one of the soft keys to select the error injection type.</p> <p>Press the Alarm Injection soft key.</p> <p>Press the AIS Alarm soft key. Toggle between On and Off to turn the AIS Alarm on or off.</p> <p>Press the RAI Alarm soft key. Toggle between On and Off to turn the RAI Alarm on or off.</p> <p>Press the Start/Stop soft key to start or stop the test.</p> |

T1 BERT Testing Procedure

MEASURE SETUP



- n **RX MODE:** Selects the receiver inputs.
 - Y **TERMINATE:** The transmitter sends data according to the transmitter settings in the Measure Setup menu, including framing, line code, and BER patterns. Terminate mode provides a nominal 100 ohm input impedance.
 - Y **BRIDGE:** Provides input impedance greater than 1k ohm for in-service monitoring, bridging the receiver input across lines that are terminated elsewhere in the network.
 - Y **MONITOR:** The monitor mode is designed for in-service monitoring of T1 lines. In monitor mode, the instrument is set to 100 ohm nominal input impedance.
- n **FRAMING:** Selects the types of framing. If the framing type of received signal is not accord with receiver setting, framing alarm occurs.
 - Y **SF-D4 (SUPER FRAME-D4):** Group of 12 frames, used to align equipment for framing.
 - Y **ESF (EXTENDED SUPER FRAME):** Group of 24 frames, used to align equipment for framing, Uses 4K for a maintenance channel (Facilities Data Link), 2K for CRC-6 checksum and 2K for framing/synchronization.
- n **LINE CODE:** Selects the types of line codes to send T1 signal.
 - Y **AMI:** It stands for Alternate Mark Inversion. A line code uses one three level signal to convey binary digits in which successive binary ones ("marks" or pulses) are of alternating polarity, either positive or negative, equal in amplitude. A binary zero ("space") is transmitted as no pulse or zero amplitude.
 - Y **B8ZS:** It stands for Bipolar with 8-Zero Substitution. A coding scheme in which the transmitter "substitutes" a fixed pattern of ones, zeros, and BPVs in place of 8 consecutive zeros.
- n **PATTERN:** Selects the type of stress patterns.
 - Y **1-8:** An eight-bit pattern that contains a single one. Used to test clock recovery.
 - Y **1-16:** A sixteen-bit pattern that contains a single one. Used to test clock recovery.
 - Y **ALL 1'S:** A pattern that causes line drivers to consume the maximum power.
 - Y **ALL 0'S:** A pattern that is often selected to verify B8ZS provisioning. Circuit will drop when the line code option is set to AMI.
 - Y **ALTERNATE:** A pattern that alternates between ones and zeroes.
 - Y **3-24:** A twenty-four bit-pattern containing 3 ones with the longest length of consecutive zeroes constrained to fifteen. It has ones density of 12.5% and is used to check clock recovery.
 - Y **QRSS:** A pseudorandom pattern that is a common test pattern and simulates live traffic on a circuit.
 - Y **2e23:** A pseudorandom pattern based on a 23 bit shift register.
 - Y **2e15:** A pseudorandom pattern based on a 15 bit shift register.

- Y **2e23 INV:** Bit inverted pseudorandom pattern based on a 23 bit shift register.
- Y **2e15 INV:** Bit inverted pseudorandom pattern based on a 15 bit shift register.
- n **TX CLOCK:** Selects the clock source to measure frequency and timing.
 - Y **INTERNAL:** Internal clock uses an internal oscillator in case of external reference is not available and the instrument does not transmit signal to synchronized equipment. The instrument provides the clock to the unit under test and most cases in Loopback test mode.
 - Y **RX:** Transmit clock uses the frequency recovered from the received signal (Network Loop), if accurate frequency measurement is required.
- n **TX LBO:** It stands for Transmit Line Build Out. Selects the line build out level. Available values for LBO are 0 dB, -7.5 dB, or -15 dB.
 - Y **0 DB:** Is used in most cases including that the test set is connected to the DSX front panel, to CSU, to NIU or Channel Bank or that the cabling is less than about 130 feet in-between test set and DSX.
 - Y **-7.5 DB AND -15 DB:** Are used in cases that attenuation is needed where the T1 line is series connected to 7.5 dB or 15 dB attenuator.

MEASURE



- n **BERT:** Sets parameters for BER testing.
 - Y **START/STOP:** Starts or stops the testing.
 - Y **EVENT LOG:** Enables or disables automatic event logging of T1 Analyzer. When the Event Log is set to on, the user can save the file name for the logging.
- n **ERROR INJECTION:** Sets the error injection type among **None**, **1E-3**, **1E-4**, **1E-5**, and **Single**.
- n **ALARM INJECTION:** Sets the alarm injection options.
 - Y **AIS ALARM:** Sets the Alarm Indication Signal to on or off. Toggle between **On** and **Off**.
 - Y **RAI ALARM:** Sets the Remote Alarm Indication to on or off. Toggle between **On** and **Off**.

Measurement Example



T1 BERT Testing Screen

LOOP TESTING

Measurement Procedure

| Step | Description |
|---|---|
| 1. Set the mode MODE [E1/T1 Analyzer] [T1 Analyzer] [Loop Test] | Press the MODE hard key. Press the E1/T1 Analyzer soft key. Press the T1 Analyzer soft key. Press the Loop Test soft key. |
| 2. Set the measurement parameters MEASURE SETUP [RX Mode] [Terminate], [Bridge], or [Monitor] [Framing] <SF-D4> or <ESF> [Line Code] | Press the MEASURE SETUP hot key. Press the RX Mode soft key. Press one of soft keys to select the receiver input. Press the Framing soft key to toggle between SF-D4 and ESF and select the framing type. Press the Line Code soft key to toggle between AMI |

| | |
|---|--|
| <p><AMI> or <B8ZS></p> <p>[Pattern] [1-8], [1-16], [All 1's], [All 0's], [Alternate], [3-24], [QRSS], [2e23], [2e15], [2e23 INV], or [2e15 INV]</p> <p>[TX Clock] <Internal> or <RX></p> <p>[TX LBO] <0dB>, <-7.5dB>, or <-15dB></p> <p>[Loop Codes] [Link] <Inband> or <Datalink> or [CSU] or [NIU]</p> | <p>and B8ZS and select line code type.</p> <p>Press the Pattern soft key. Press one of the soft keys to select stress pattern.</p> <p>Press the TX Clock soft key to toggle between Internal and RX and select the timing source.</p> <p>Press the TX LBO soft key. Toggle between 0dB, -7.5dB and -15dB to select the TX line build out level.</p> <p>Press the Loop Codes soft key. Select a loop code to choose among Link (Inband and Datalink), CSU and NIU. Toggle the Link soft key between Inband and Datalink to select one or press the CSU or NIU soft key.</p> |
| <p>3. Set the test parameters</p> <p>MEASURE</p> <p>[Loop Test] [Event Log] <On> or <Off></p> <p>[Remote Loop Up], [Remote Loop Dn], [Self Loop Up], or [Self Loop Dn]</p> <p>[Error Injection] [None], [1E-3], [1E-4], [1E-5], or [Single]</p> <p>[Alarm Injection] [AIS Alarm] <On> or <Off> [RAI Alarm] <On> or <Off></p> <p>[Start/Stop]</p> | <p>Press the MEASURE hot key. Press the Loop Test soft key. Press the Event Log soft key to toggle between On and Off and select the event log option.</p> <p>Press one of the soft keys to activate or deactivate external or internal loop back option.</p> <p>Press the Error Injection soft key. Press one of the soft keys to select the error injection type.</p> <p>Press the Alarm Injection soft key. Press the AIS Alarm soft key. Toggle between On and Off to turn the AIS Alarm on or off. Press the RAI Alarm soft key. Toggle between On and Off to turn the RAI Alarm on or off.</p> <p>Press the Start/Stop soft key to start or stop the test.</p> |

T1 Loop Testing Procedure

MEASURE SETUP



- n **RX MODE:** Selects the receiver inputs.
 - Y **TERMINATE:** The transmitter sends data according to the transmitter settings in the Measure Setup menu, including framing, line code, and BER patterns. Terminate mode provides a nominal 100 ohm input impedance.
 - Y **BRIDGE:** Provides input impedance greater than 1k ohm for in-service monitoring, bridging the receiver input across lines that are terminated elsewhere in the network.
 - Y **MONITOR:** The monitor mode is designed for in-service monitoring of T1 lines. In monitor mode, the instrument is set to 100 ohm nominal input impedance.
- n **FRAMING:** Selects the types of framing. If the framing type of received signal is not accord with receiver setting, framing alarm occurs.
 - Y **SF-D4 (SUPER FRAME-D4):** Group of 12 frames, used to align equipment for framing.
 - Y **ESF (EXTENDED SUPER FRAME):** Group of 24 frames, used to align equipment for framing, Uses 4K for a maintenance channel (Facilities Data Link), 2K for CRC-6 checksum and 2K for framing/synchronization.
- n **LINE CODE:** Selects the types of line codes to send T1 signal.
 - Y **AMI:** It stands for Alternate Mark Inversion. A line code uses one three level signal to convey binary digits in which successive binary ones ("marks" or pulses) are of alternating polarity, either positive or negative, equal in amplitude. A binary zero ("space") is transmitted as no pulse or zero amplitude.
 - Y **B8ZS:** It stands for Bipolar with 8-Zero Substitution. A coding scheme in which the transmitter "substitutes" a fixed pattern of ones, zeros, and BPVs in place of 8 consecutive zeros.
- n **PATTERN:** Selects the type of stress patterns.
 - Y **1-8:** An eight-bit pattern that contains a single one. Used to test clock recovery.
 - Y **1-16:** A sixteen-bit pattern that contains a single one. Used to test clock recovery.
 - Y **ALL 1'S:** A pattern that causes line drivers to consume the maximum power.
 - Y **ALL 0'S:** A pattern that is often selected to verify B8ZS provisioning. Circuit will drop when the line code option is set to AMI.
 - Y **ALTERNATE:** A pattern that alternates between ones and zeroes.
 - Y **3-24:** A twenty-four bit-pattern containing 3 ones with the longest length of consecutive zeroes constrained to fifteen. It has ones density of 12.5% and is used to check clock recovery.
 - Y **QRSS:** A pseudorandom pattern that is a common test pattern and simulates live traffic on a circuit.

- Y **2e23**: A pseudorandom pattern based on a 23 bit shift register.
 - Y **2e15**: A pseudorandom pattern based on a 15 bit shift register.
 - Y **2e23 INV**: Bit inversed pseudorandom pattern based on a 23 bit shift register.
 - Y **2e15 INV**: Bit inversed pseudorandom pattern based on a 15 bit shift register.
- n **TX CLOCK**: Selects the clock source to measure frequency and timing.
- Y **INTERNAL**: Internal clock uses an internal oscillator in case of external reference is not available and the instrument does not transmit signal to synchronized equipment. The instrument provides the clock to the unit under test and most cases in Loopback test mode.
 - Y **RX**: Transmit clock uses the frequency recovered from the received signal (Network Loop), if accurate frequency measurement is required.
- n **TX LBO**: It stands for Transmit Line Build Out. Selects the line build out level. Available values for LBO are **0 dB**, **-7.5 dB**, or **-15 dB**.
- Y **0 DB**: Is used in most cases including that the test set is connected to the DSX front panel, to CSU, to NIU or Channel Bank or that the cabling is less than about 130 feet in-between test set and DSX.
 - Y **-7.5 DB AND -15 DB**: Are used in cases that attenuation is needed where the T1 line is series connected to 7.5 dB or 15 dB attenuator.
- n **LOOP CODES**: Sets the loop code.
- Y **LINK**: Toggle between **Inband** and **Datalink** to select the link option. Datalink is used when the framing is set to ESF.
 - Y **CSU**: Selects the Channel Service Unit codes.
 - Y **NIU**: Selects the Network Interface Unit codes.

MEASURE



- n **LOOP TEST**: Sets parameters for Loop testing.
- Y **START/STOP**: Starts or stops the testing.
 - Y **EVENT LOG**: Enables or disables automatic event logging of T1 Analyzer. When the Event Log is set to on, the user can save the file name for the logging.
 - Y **REMOTE LOOP UP**: Activates external loop back so that the instrument sends the system a request of the loop back mode.
 - Y **REMOTE LOOP DN**: Deactivates external loop back so that the instrument sends the system a request of clearing the loop back mode.

- Y **SELF LOOP UP:** Activates internal loop back.
- Y **SELF LOOP DN:** Deactivates internal loop back, reverting the instrument to a through mode.
- n **ERROR INJECTION:** Sets the error injection type among **None**, **1E-3**, **1E-4**, **1E-5**, and **Single**.
- n **ALARM INJECTION:** Sets the alarm injection options.
- Y **AIS ALARM:** Sets the Alarm Indication Signal to on or off. Toggle between **On** and **Off**.
- Y **RAI ALARM:** Sets the Remote Alarm Indication to on or off. Toggle between **On** and **Off**.

Measurement Example

The screenshot displays the 'Loop Test' interface on a T1 Analyzer. The top status bar shows 'Mode: T1 Analyzer', 'Loop Test', 'Event Logging: Off', 'Start Time: 01/07 19:04:14', and 'Elapsed Time: 00:00:18'. The main area is divided into several sections:

- Control Panel:** Includes 'Loop Test', 'Start/Stop', 'Clear', 'Event Log', 'Remote Loop Up', 'Remote Loop Dn', 'Self Loop Up', and 'More (1/2)' buttons.
- Configuration Table:**

| | Current | History | Current | History |
|--------------|---------|---------|--------------------|---------|
| T1 Signal | ● | ● | Red Alarm | ● |
| Frame Sync | ● | ● | RAI (Yellow Alarm) | ● |
| Pattern Sync | ● | ● | AIS (Blue Alarm) | ● |
| BB25 | ● | ● | BPV | ● |
- Loss Count Table:**

| Loss Count | Value | Alarm Count | Value |
|-------------------|-------|-------------|-------|
| Signal Loss | 0 | RAI | 0 |
| Frame Sync Loss | 0 | AIS | 0 |
| Pattern Sync Loss | 0 | BPV | 23366 |
- Error Rate Section:**

| Error Rate | |
|-----------------|----------|
| BIT Error Rate | 9.91e-05 |
| BIT Error Count | 40556 |
- Bottom Controls:** 'TX On', 'Error Injection On', and 'Loop Off' buttons.

T1 Loop Testing Screen

Interference Analyzer

This Interference Analyzer function is optional that the JD740A series offers as the Option 011. It includes what are needed to monitor, identify and locate interferences using the Spectrogram, RSSI, Interference Finder, Spectrum Replayer, and audible beep sound, which is proportional to its strength.

In this Chapter

| | |
|---|----|
| Using Interference Analyzer | 3 |
| Display Overview | 3 |
| Spectrogram | 3 |
| Received Signal Strength Indicator (RSSI) | 5 |
| Connection Diagram | 7 |
| Spectrum Measurements | 8 |
| Setting Mode | 8 |
| Setting Frequency | 8 |
| Setting Amplitude | 10 |
| Setting Bandwidth | 12 |
| Setting Averaging | 12 |
| Setting Sweep | 13 |
| Setting Trace and Display | 15 |
| Setting Event Save | 16 |
| Setting Limit | 16 |
| Sound Indicator | 20 |
| Measurement Procedure | 20 |
| AM/FM Audio Demodulation | 21 |
| Measurement Procedure | 22 |
| Interference ID | 23 |
| Measurement Procedure | 23 |
| Measurement Example | 25 |
| Interference Measurements | 26 |
| Setting Mode | 26 |
| Setting Frequency | 26 |
| Setting Amplitude | 28 |
| Setting Bandwidth | 30 |
| Setting Averaging | 30 |
| Setting Sweep | 31 |
| Setting Limit | 33 |
| Spectrogram | 33 |
| Measurement Procedure | 34 |
| Measurement Example | 35 |
| RSSI | 36 |
| Measurement Procedure | 36 |

| | |
|-----------------------------|----|
| Measurement Example | 38 |
| Interference Finder | 39 |
| Measurement Procedure | 40 |
| Measurement Example | 43 |
| Spectrum Replayer | 43 |
| Measurement Procedure | 43 |
| Setting Limit | 46 |
| Analysis | 49 |
| Using Marker | 49 |
| Using Peak Search | 50 |

(Rev. 6.0)

USING INTERFERENCE ANALYZER

Interference is becoming more prevalent in the wireless community with the increasing number of transmitters coming on the air. Wireless service providers have traditionally used spectrum analyzers to monitor service channels, frequencies, and adjacent spectrum and to locate sources of interference. A spectrum analyzer can only show the user an interfering signal and the user requires determining the source of the interference. To solve interference problems, the user must understand the RF environment, know adjacent operating transmitters, and identify any new or unlicensed emitters.

Once a potential interfering signal is identified in the Spectrum Analyzer mode, the user can monitor the signal further in the Interference Analyzer mode. JD740A series provides two different methodologies to indentify/determine interference signals, Spectrogram and Received Signal Strength Indicator (RSSI). Locating the source of interference signal can be done with geographical information received from built-in GPS receiver.

The JD740A series has followings measurement for interference analysis:

- n Spectrum
- n Spectrogram
- n RSSI (Received Signal Strength Indicator)
- n Interference Finder
- n Spectrum Replayer

DISPLAY OVERVIEW

Spectrogram

Measurement Mode Information: Interference Analyzer

Spectrum Input Level Setting Information: This window shows the most common settings or parameters of each measurement.

- Frequency and Channel Setting
- Amplitude Setting (Preamp, Attenuation, External Offset)
- Reference Setting (Frequency, Trigger)

Measurement Setting Information

- Spectrum Analyzer Operation Mode Information
- Detector Type Setting Information
- Spectrum Setting Information (RBW, VBW)
[A]: Auto mode, [M]: Manual mode
- Sweep Time Information: Displays current sweep time
- Average Number Information set through BW/AVG hard key. It shows the number of traces to be averaged.

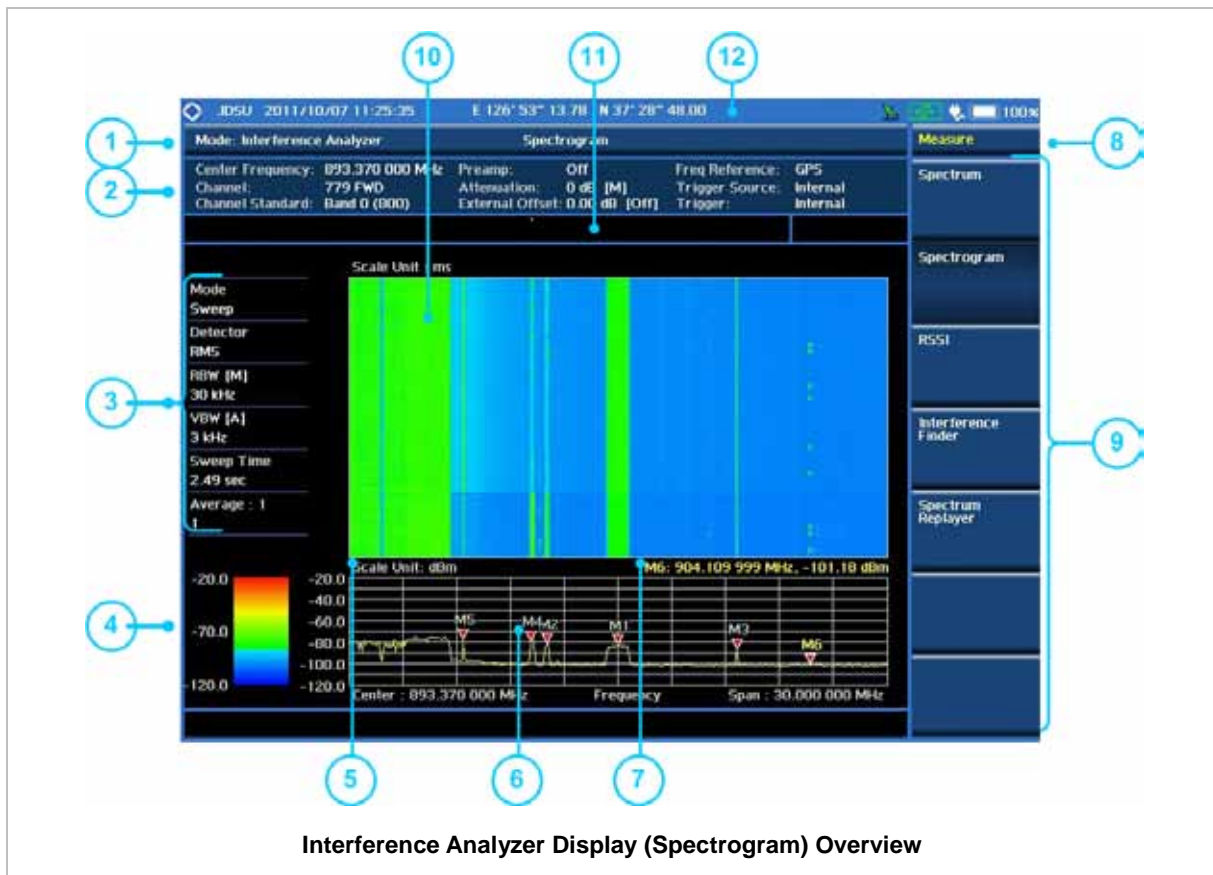

Color Identification (Spectrogram): Indicates power level of the tracked signal on the waterfall diagram

Scale Unit Information: dBm, dBV, dBmV, dBuV, V, and W

Waveform Window: Displays signal with specified frequency range

Marker information on both frequency and power in specified unit

Screen Menu Title

Screen Menu and Sub-menu

Spectrogram Screen: Displays signal strength on the received signal over time

User Input Window: Activates when user input menu or key is selected. Pressing ESC hard key will cancel or deactivate user input window. Inactivate user input window before using hot keys.

NOTE: It is very important to inactivate the user input window when you intend to use the hot

key menu on the numeric keys.

System Information

- Date and Time
- Positioning Information (Longitude and Latitude). It is available only when a GPS antenna is connected. Frequency reference is automatically set to GPS in the System menu when a GPS antenna is connected.
- Frequency Reference Indicator: INT for internal and EXT for external. The EXT icon is green when an external reference is locked or red when the external reference is not locked. When a GPS antenna is connected, this space will be blank.
- GPS Indicator: Color of the GPS icon changes among green, yellow and gray depending on locking status.
- USB Indicator
- DC Input Power Indicator
- Battery Indicator

Received Signal Strength Indicator (RSSI)

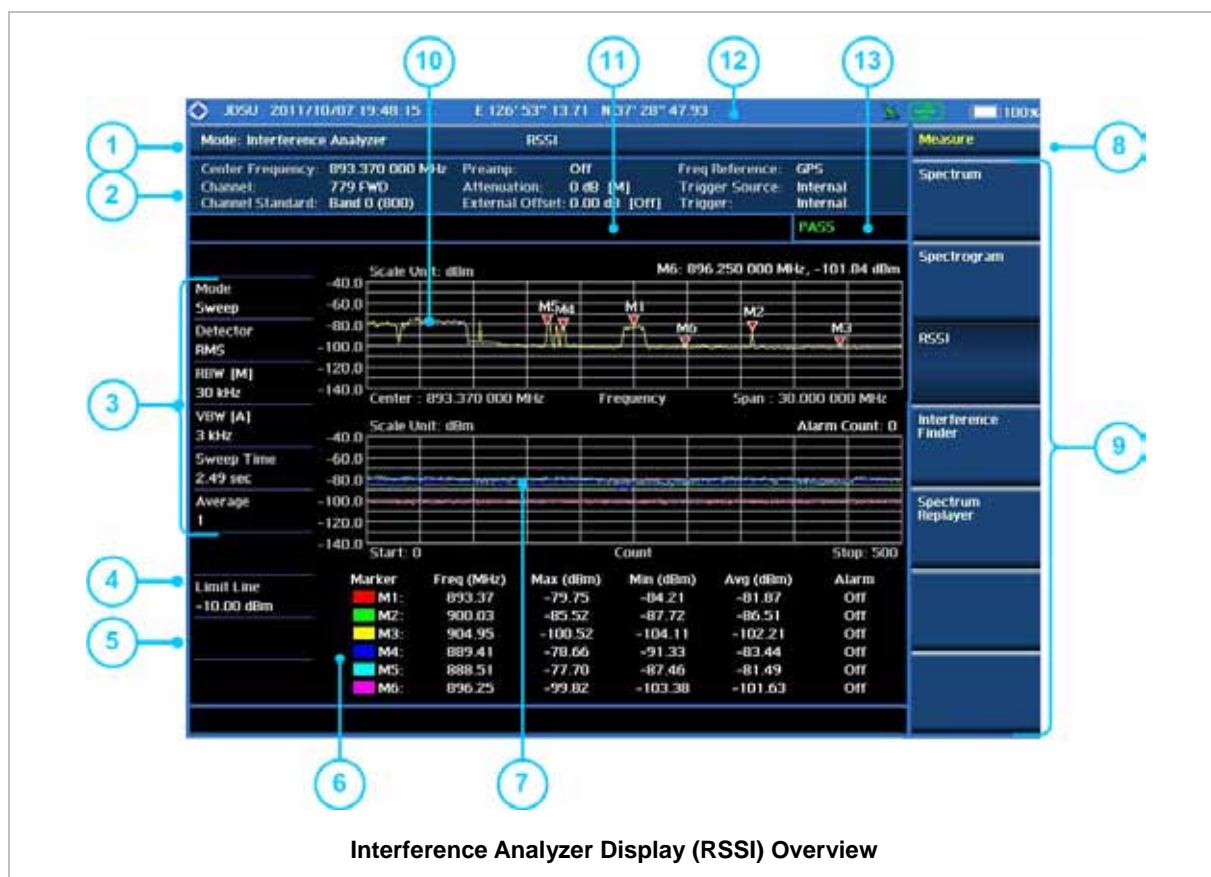

Measurement Mode Information

Spectrum Input Level Setting Information

- Frequency and Channel Setting

- Amplitude Setting (Preamp, Attenuation, External Offset)
- Reference Setting (Frequency, Trigger)

Measurement Setting Information

- Spectrum Analyzer Operation Mode Information
- Detector Type Setting Information
- Spectrum Setting Information (RBW, VBW)
[A]: Auto mode, [M]: Manual mode
- Sweep Time Information: Displays current sweep time
- Average Number Information set through BW/AVG hard key. It shows the number of traces to be averaged.

Limit Setting Information

Alarm Indication Setting Status

Marker information with Max, Min, and Avg power of received signals

Histogram Window: Displays power variations of 6 different frequency components over time

Screen Menu Title

Screen Menu and Sub-menu

Waveform Window: Displays signal with specified frequency range

User Input Window: Activates when user input menu or key is selected. Pressing ESC hard key will cancel or deactivate user input window. Inactivate user input window before using hot keys.

NOTE: It is very important to inactivate the user input window when you intend to use the hot key menu on the numeric keys.

System Information

- Date and Time
- Positioning Information (Longitude and Latitude). It is available only when a GPS antenna is connected. Frequency reference is automatically set to GPS in the System menu when a GPS antenna is connected.
- Frequency Reference Indicator: INT for internal and EXT for external. The EXT icon is green when an external reference is locked or red when the external reference is not locked. When a GPS antenna is connected, this space will be blank.
- GPS Indicator: Color of the GPS icon changes among green, yellow and gray depending on locking status.
- USB Indicator
- DC Input Power Indicator
- Battery Indicator

Pass/Fail Indication

CONNECTION DIAGRAM

Connect an Omni/directional RF antenna to the **Spectrum Analyzer RF In 50 Ω** port of the JD740A series and then a GPS antenna to the **GPS** port of the JD740A series.

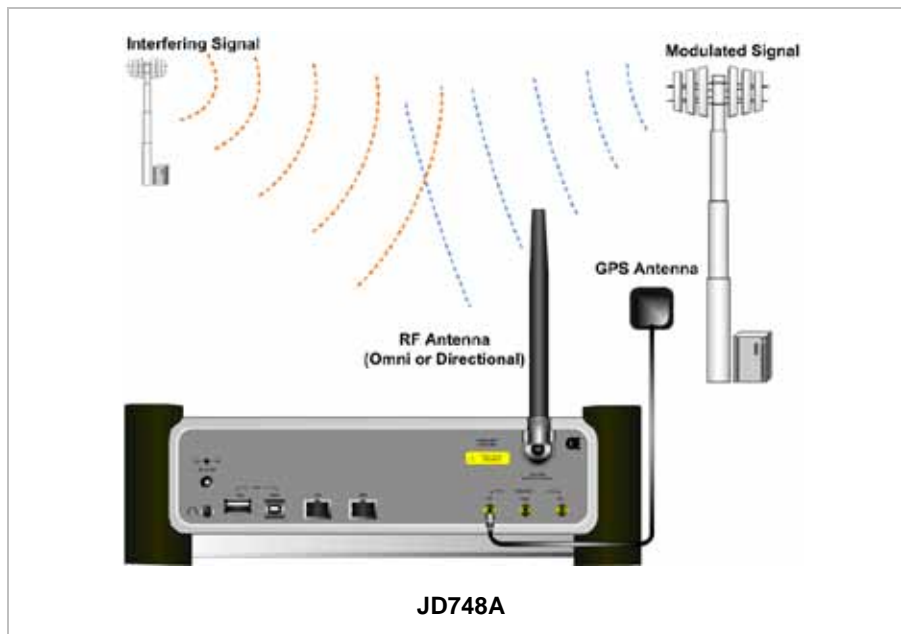
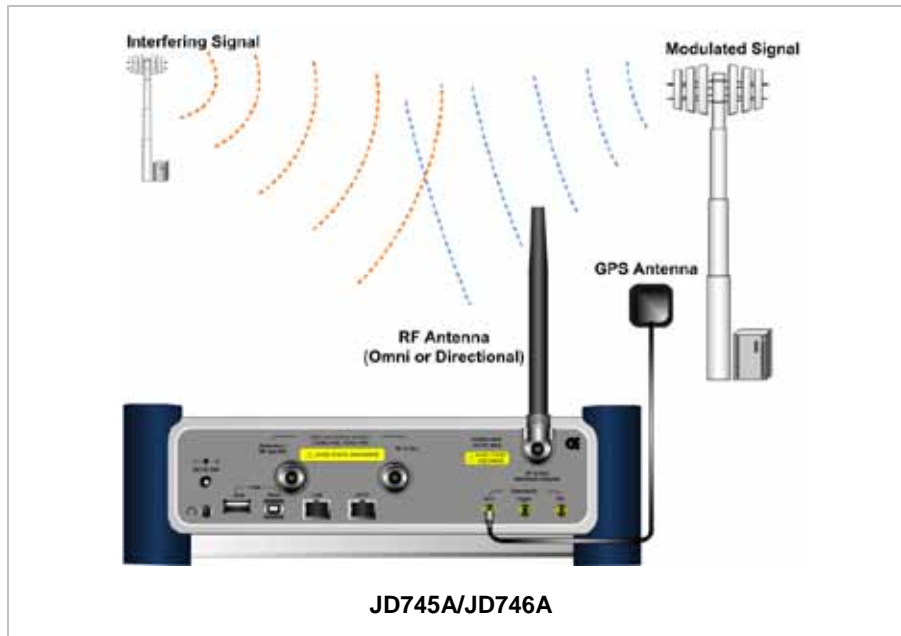

If the input signal level to be measured is less than 0 dBm, set it to 0 dB attenuation or turn on the preamp to have better dynamic range for the testing.

SPECTRUM MEASUREMENTS

Spectrum Measurements in the Interference Analyzer mode provide the following essential functions.

- n Sound Indicator
- n AM/FM Audio Demodulation
- n Interference ID

Setting Mode

| Step | Description |
|--|---|
| 1. Connect antennas | Connect antennas as shown in the Connection Diagram on page 7 of this chapter. |
| 2. Select the mode MODE [Interference Analyzer] [Spectrum] | Press the MODE hard key. Press the Interference Analyzer soft key. Press the Spectrum soft key. (Spectrum mode is set by default.) |

Setting Frequency

| Step | Description |
|---|---|
| 1. Set the frequency FREQ/DIST [Unit] <Freq> or <Channel> <i>When Freq is selected:</i> [Center Frequency] Enter a value [GHz], [MHz], [kHz], or [Hz] [Span] [Span], [Full Span], [Zero Span], or [Last Span] Enter a value [GHz], [MHz], [kHz], or [Hz] | Press the FREQ/DIST hard key. Press the Unit soft key. Toggle this key between Freq and Channel . A set of Freq/Dist screen menu changes accordingly. Press the Center Frequency soft key. Use the rotary knob or the arrow keys. Or use the numeric keys to input value and then press one of the unit soft keys to complete the input. Press the Span soft key in the Freq/Dist menu bar. Press one of the soft keys to select. When the Span is selected, use the rotary knob or the arrow keys to change value. Or use the numeric keys to input value and then press one of the unit soft keys to complete the input. |

| | |
|--|---|
| <p>or</p> <p>[Start Frequency] Enter a value [GHz], [MHz], [kHz], or [Hz]</p> <p>[Stop Frequency] Enter a value [GHz], [MHz], [kHz], or [Hz]</p> <p><i>When Channel is selected:</i></p> <p>[Channel Standard] Select a band</p> <p>[Channel Number] Enter a value [Enter] or ENTER</p> <p>[Span] [Span], [Full Span], [Zero Span], or [Last Span] Enter a value [GHz], [MHz], [kHz], or [Hz]</p> <p>[Link] <FWD> or <REV></p> | <p>Press the Start Frequency soft key. Use the rotary knob or the arrow keys. Or use the numeric keys to input value and then press one of the unit soft keys to complete the input.</p> <p>Press the Stop Frequency soft key. Use the rotary knob or the arrow keys. Or use the numeric keys to input value and then press one of the unit soft keys to complete the input.</p> <p>Press the Channel Standard soft key. Select a band to be measured by using the rotary knob, the arrow keys, or Page Up/Page Down soft keys. Press the Select soft key to confirm the selection.</p> <p>Press the Channel Number soft key. Use the numeric keys to input value and press the Enter soft key or ENTER hard key to complete the input. The instrument automatically displays its corresponding center frequency value for the channel number.</p> <p>Press the Span soft key in the Freq/Dist menu bar. Press one of the soft keys to select. When the Span is selected, use the rotary knob or the arrow keys to change value. Or use the numeric keys to input value and then press one of the unit soft keys to complete the input.</p> <p>Press the Link soft key to set the link direction. Toggle this key between FWD and REV.</p> |
|--|---|

FREQ/DIST



There are three ways to set the frequency band: center frequency/span, start frequency/stop frequency, and channel number/span.

- n **UNIT:** Determines the way how to set the frequency band either with standard band or custom frequency band. Toggling this key between **Freq** and **Channel** changes a set of Freq/Dist screen menu automatically.

When the unit is set to Frequency:

- n **CENTER FREQUENCY:** Changes the center frequency setting in the spectrum measurement. Use the rotary knob or the arrow keys. Or use the numeric keys to input a certain value and press

one of the unit soft keys to complete the input.

- n **SPAN:** Sets the frequency range over which the instrument will sweep.
- n **START FREQUENCY:** Changes the start frequency in the spectrum measurement. Use the rotary knob or the arrow keys. Or use the numeric keys to input a certain value and press one of the unit soft keys to complete the input.
- n **STOP FREQUENCY:** Changes the stop frequency in the spectrum measurement. Use the rotary knob or the arrow keys. Or use the numeric keys to input a certain value and press one of the unit soft keys to complete the input.
- n **FREQUENCY STEP:** Defines the amount of frequency to be increased or decreased when using the rotary knob or the arrow keys to change the **Center Frequency**, **Start Frequency**, or **Stop Frequency**. This frequency step size can be entered by using numeric keys and the unit soft keys.

When the unit is set to Channel:

- n **CHANNEL NUMBER:** Enters a channel number. The instrument automatically displays its corresponding center frequency value for the channel number.
- n **SPAN:** Sets the frequency range over which the instrument will sweep.
- n **CHANNEL STEP:** Defines the amount of channel to be increased or decreased when using the rotary knob or the arrow keys to change the **Channel Number**. This channel step size can be entered by using numeric keys and the **Enter** soft key.
- n **LINK:** Sets the direction of sweeping. Toggle this key between **FWD** and **REV**.
- n **CHANNEL STANDARD:** When the channel standard is selected from the list, the center frequency information on the display screen will be mapped accordingly to the selected channel standard. The channel standards available in the instrument are listed in the Appendix C – Band, Frequency & Channel Standard.

Setting Amplitude

| Step | Description |
|--|--|
| 1. Set the reference/attenuation level AMP/SCALE [Auto Scale] or [Reference Level] Enter a reference level value | Press the AMP/SCALE hard key. Press the Auto Scale soft key to automatically set optimum levels of reference and attenuation. Press the Reference Level soft key to set manually. Use the numeric keys or the rotary knob that changes in a 10 |

| | |
|----------------------------|---|
| [dBm] or ENTER | dB step. Press the dBm soft key or the ENTER hard key. |
| [Attenuation] | Press the Attenuation soft key. The Auto mode is set by default. This key toggles between the Auto and Manual . |
| <Manual> | Press the Attenuation soft key to highlight the Manual mode and change the attenuation value to optimize S/N. |
| Enter an attenuation value | Use the numeric keys or the rotary knob that changes in a 5 dB step. The attenuation setting range is 0 to 50 dB. |

AMP/SCALE



- n **AUTO SCALE:** The instrument can automatically set the scale to the minimum and maximum values on the Y-axis of the graph for optimum display of the traces measured. Each time the **Auto Scale** is selected, the top and bottom scales are set to the minimum and maximum values with margin on the Y-axis of the display screen.
- n **REFERENCE LEVEL:** Sets the maximum Y-axis.
- n **SCALE/DIV:** Is used only for the Spectrum measurement screen. It represents the value of one division on the horizontal scale. The default value is 10 dB per division and the Y-Scale is set to 100 dB. Selecting the **Scale/Div** soft key enables to set the value to 1 dB per division with the numeric keys or the rotary knob.
- n **ATTENUATION**
 - Y **AUTO:** Input attenuator's value is automatically set depending on the reference level. This is the default operation mode, so it is recommended to use this mode unless a special measurement condition is needed.
 - Y **MANUAL:** Sets the attenuator's value for the **Spectrum Analyzer RF In 50 Ω** port.
- n **PREAMP:** Turns on or off the internal pre-amplifier. Preamp results in a correction being applied to compensate for the gain of the preamp so that amplitude readings show the value at the input connector. This soft key toggles between the **On** and **Off**. When it is set to On, the allowable attenuation input range is from 0 dB to 10 dB in a multiple of 5. If the attenuation value is manually set greater than 10 dB, the instrument will automatically turn off the pre-amplifier to display low level signal properly on the screen.
- n **UNITS:** Sets the scale unit on the display among **dBm**, **dBV**, **dBmV**, **dBuV**, **V**, and **W**.
- n **EXTERNAL OFFSET:** Sets an external offset value. An offset consists of a cable loss and a user offset and the measurement result shows the value reflecting both offset values. When the external offset value is set at 40 dB in the Spectrum mode, the measurement result compensates 40 dB at both the Spectrum Analyzer and Signal Analyzer modes.

Setting Bandwidth

| Step | Description |
|--|---|
| 1. Set the bandwidth BW/AVG [RBW] Enter RBW value [MHz], [kHz], or [Hz] [VBW] Enter VBW value [MHz] or [kHz] or [Hz] [VBW/RBW] <1>, <0.3>, <0.1>, <0.03>, <0.01>, or <0.003> | Press the BW/AVG hard key. Press the RBW soft key. Use the numeric keys and the unit soft keys or the rotary knob. Press the VBW soft key. Use the numeric keys and the unit soft keys or the rotary knob. Press the VBW/RBW soft key. Each time the key is pressed the selection changes in sequence from 1 to 0.003. |

BW/AVG



- n **RBW:** Sets the Resolution Bandwidth (RBW) of the Spectrum Analyzer. Toggles between the **Auto** and **Manual**. When the **Auto** is selected, the RBW is selected based on the frequency span. When the **Manual** is selected, the RBW can be set from 1 Hz to 3 MHz in a 1-3 sequence using the numeric keys, the arrow keys, or the rotary knob.
- n **VBW:** Sets the Video Bandwidth (VBW) of the Spectrum Analyzer. Toggles between the **Auto** and **Manual**. When the **Auto** is selected, the VBW is selected based on the current RBW and RBW/VBW settings.
- n **VBW/RBW:** Sets proportional VBW based on the designated RBW. Every time the VBW/RBW soft key is pressed the ration selection changes. For the user's better understanding of the rather complicated formula, the table shows the VBW setting in proportion to the VBW/RBW ratio at 30 kHz RBW setting as an example.

| RBW | VBW/RBW Ratio | VBW |
|--------|---------------|--------|
| 30 kHz | 1:1 | 30 kHz |
| | 1:0.3 | 10 kHz |
| | 1:0.1 | 3 kHz |
| | 1:0.03 | 1 kHz |
| | 1:0.01 | 300 Hz |
| | 1:0.003 | 100 Hz |

Setting Averaging

BW/AVG



- n **AVERAGE:** Sets the number of measurements to be averaged for the trace presentation. A maximum of 100 times of averaging can be set.

| Step | Description |
|---|---|
| 1. Set the averaging BW/AVG [Average] | Press the BW/AVG hard key. Press the Average soft key. |
| 2. Enter number of averaging to set | Use the numeric keys and input a number between 1 and 100. When the averaging reaches to the number set here, a new measurement value replaces the earliest measurement value in sequence. |
| 3. [Enter] or ENTER | Press the Enter soft key or the ENTER hard key. |

Setting Sweep

SWEEP



This hot key is used to set and control the sweep parameters such as Sweep Time, Sweep Mode, Gated Sweep Settings and Gated Sweep On/Off. The user input window must be inactive first to get the Sweep hot key function other than the number input.

- n **SWEEP TIME:** Sets the sweep time automatically or manually by toggling this soft key between **Auto** and **Manual**. Use the numeric keys to input value manually and press one of the unit soft keys among **Sec**, **mSec**, and **uSec** to complete the input.
- n **SWEEP MODE:** Sets the sweep mode.

| Step | Description |
|--|--|
| 1. Set the sweep mode SWEEP [Sweep Mode] <Continue> or <Single> | Press the SWEEP hot key. Press the Sweep Mode soft key. Toggle this key between Continue and Single . |

- n **GATED SWEEP SETTINGS:** Sets the gated sweep parameters with internal trigger source. Pressing the Gated Sweep Settings automatically changes the measurement display from frequency domain to time domain.

| Step | Description |
|--|--|
| 1. Set the gated sweep parameters SWEEP [Gated Sweep Settings] | Press the SWEEP hot key. Press the Gated Sweep Settings soft key. |

| | |
|--|--|
| <p>[Period] <StdSignal> or <Manual></p> <p>Enter a value [Sec], [mSec], or [uSec]</p> <p>[StdSignal] [GSM (4.615 ms)], [WCDMA (10 ms)], [LTE (10 ms)], [EV-DO (5 ms)], [TD-SCDMA (5 ms)], or [WiMAX (10 ms)]</p> | <p>Press the Period soft key to select a standard signal or period manually. Toggle this key between StdSignal and Manual.</p> <p>Use the numeric keys to input value of period manually. Press one of the unit soft keys to select.</p> <p>Press the StdSignal to select a standard signal for the period. This soft key is activated when the StdSignal is selected for the Period setting above. Select one of the signal soft keys to choose.</p> |
| <p>2. Set the trigger TRIGGER [Video] or [Display Position]</p> <p>PREV</p> | <p>Press the TRIGGER hot key after setting the Period. Press the Video or Display Position soft key to set the trigger type.</p> <p>Press the PREV hard key in order to go back to the Gated Sweep Settings menu.</p> |
| <p>3. Continue setting the gated sweep parameters</p> <p>[Zero Span Time] Enter a value [Sec], [mSec], or [uSec]</p> <p>[Gate Delay] Enter a value [Sec], [mSec], or [uSec]</p> <p>[Gate Length] Enter a value [Sec], [mSec], or [uSec]</p> <p>PREV</p> | <p>Press the Zero Span Time soft key. Use the numeric keys to input value of sweep time. Press one of the unit soft keys to select.</p> <p>Press the Gate Delay soft key and then turn the rotary knob to change the gate delay gradually. Or use the numeric keys to input value of gate delay and then press one of the unit soft keys to complete the input.</p> <p>Press the Gate Length soft key and then turn the rotary knob to change the gate length gradually. Or use the numeric keys to input value of gate length and then press one of the unit soft keys to complete the input.</p> <p>Press the PREV hard key in order to go back to the Sweep menu and to start gated sweeping.</p> |

Y **ZERO SPAN TIME:** Sets the zero span sweep time manually.

Y **GATE DELAY:** Sets the gated sweep delay.

Y **GATE LENGTH:** Sets the gated sweep length.

- Y **PERIOD:** Sets the period by selecting a standard signal from available choices or by manually entering a value.
- Y **STDSIGNAL:** Sets the type of standard signal used for the **Period** among **GSM (4.615 ms)**, **WCDMA (10 ms)**, **LTE (10 ms)**, **EV-DO (5 ms)**, **TD-SCDMA (5 ms)**, and **WiMAX (10 ms)**.
This soft key is activated when the **Period** setting is set to the **StdSignal**.
- n **GATED SWEEP:** Enables or disables gated sweep.

Setting Trace and Display

TRACE/DISPLAY



- n **SELECT TRACE:** Selects an active trace from T1 to T6. Trace numbers are assigned to each captured trace or loaded trace. Pressing one of the 6 trace number soft keys sets the selected trace number as the active trace on the display screen.
- n **CLEAR WRITE:** Clears the selected trace and writes or assigns the current trace.
- n **MAX HOLD:** Sets the active trace to display the maximum response of the input signal. Active trace compares newly acquired data with the trace shown on the screen and displays the bigger trace on the display screen.
- n **MIN HOLD:** Sets the active trace to display the minimum response of the input signal. Active trace compares newly acquired data with the trace shown on the screen and displays the smaller trace on the display screen.
- n **CAPTURE:** Captures a current trace on the display screen with the selected trace number.
- n **TRACE VIEW:** Displays the trace of the selected trace number on the display screen or hides it from the display screen. Press the **Select Trace** soft key to select a trace number and then press the **Trace View** soft key to toggle between the **Off** to hide and **On** to restore a hidden trace.
- n **TRACE CLEAR ALL:** Deletes all traces from the instrument and initializes the trace settings.
- n **DETECTORS:** Selects a detection method of how the measurements in each data point are displayed on the X-axis. There are 5 detection methods available in the spectrum measurements.
 - Y **NORMAL:** Displays random noise better than the Peak does without missing signals.
 - Y **PEAK:** Displays the highest value of the measurements in each data point.
 - Y **RMS:** Displays the Root Mean Squared (RMS) average power of the measurements across the spectrum.
 - Y **NEGATIVE PEAK:** Displays lowest value of the measurements in each data point.
 - Y **SAMPLE:** Displays the center value of the measurements in each data point.

Setting Event Save

The JD740A series provides Event Save function that allows the user to automatically save measurement screen or trace in case the measurement result is **Fail**. If the result is Pass, this function will not be executed.

| Step | Description |
|--|--|
| 1. Set the event save parameters MEASURE SETUP [Event Save] [Event Save] <On> or <Off> [Save Type] <Screen> or <Trace> [Location] <Internal> or <USB> | Press the MEASURE SETUP hot key. Press the Event Save soft key. Press the Event Save soft key in the Event Save menu bar. Toggle this soft key between On and Off . Press the Save Type soft key. Toggle this soft key between Screen and Trace . Press the Location soft key to set where to save. Toggle this soft key between Internal and USB . |

MEASURE SETUP



- n **EVENT SAVE:** Sets the event save parameters.
- Y **EVENT SAVE:** Turns Event Save function on or off by toggling this soft key between **On** and **Off**. When this is set to On, the screen keyboard pops up for the user to set a file name.
- Y **SAVE TYPE:** Sets what to save: measurement screen or trace.
- Y **LOCATION:** Sets where to save: the instrument's internal memory or an external USB memory device.

Setting Limit

LIMIT



This hot key is used to set the threshold value for the display on the display screen. It turns on or off the display line, multi-segment line, or channel power limit of the measurement. The user input window must be inactive first to get the Limit hot key function other than the number input.

| Step | Description |
|------------------|-------------|
| 1. Set the limit | |

| | |
|--|--|
| <p>LIMIT</p> <p>[Display Line] <On> or <Off> Enter a value [dBm] or ENTER</p> <p>[Multi Segment Line] [Auto Set]</p> <p>Or</p> <p>[Multi Segment Line] [Limit] <Upper> or <Lower></p> <p>[Limit] <On> or <Off></p> <p>[# of Line] Enter a value [Enter] or [ENTER]</p> <p>[Edit Limit]</p> <p>[Line] <On> or <Off> [Frequency/Distance] Enter a value [GHz], [MHz], [kHz], or [Hz] [Amplitude] Enter a value [dBm] or [ENTER] [Add Point]</p> <p>[Delete Point]</p> <p>[Move Point Left]</p> <p>[Move Point Right]</p> | <p>Press the LIMIT hot key.</p> <p>Press the Display Line soft key to toggle between On and Off and select one.</p> <p>Use the numeric keys to input limit value.</p> <p>Press the unit soft key or the ENTER hard key.</p> <p>Press the Multi Segment Line soft key.</p> <p>Press the Auto Set soft key to set the segment line limit automatically.</p> <p>Press the Multi Segment Line soft key.</p> <p>Press the Limit soft key to set the pass/fail criteria upper or lower segment limit. Toggle this key between Upper and Lower.</p> <p>Press the Limit soft key to enable or disable the upper or lower segment line on the display screen.</p> <p>Press the # of Line soft key to set segment line numbers to use.</p> <p>Use the numeric keys to input value between 1 and 25.</p> <p>Press the Enter soft key or the ENTER hard key.</p> <p>Press the Edit Limit soft key to edit segment line(s) properties.</p> <p>Press the Line soft key to draw a line or not. Toggle this key between On and Off.</p> <p>Press the Frequency/Distance soft key.</p> <p>Use the numeric keys to input value.</p> <p>Press one of the unit soft keys to complete the input.</p> <p>Press the Amplitude soft key.</p> <p>Use the numeric keys to input value.</p> <p>Press the unit soft key or the ENTER hard key.</p> <p>Press the Add Point soft key to add a point on the right-hand side of the active point.</p> <p>Press the Delete Point soft key to delete the active point.</p> <p>Press the Move Point Left soft key to select a point next to the left as an active point.</p> <p>Press the Move Point Right soft key to select a point next to the right as an active point.</p> |
|--|--|

| | |
|---|---|
| <p>[Move Limit] [Limit Up/Down] Enter a value [dB] or [ENTER] [Limit Left/Right]</p> | <p>Press the Move Limit soft key. Press the Limit Up/Down soft key to move the multi-segment line upward or downward. Use the numeric keys to input value. Press the dB unit soft key or the ENTER hard key. Press the Limit Left/Right soft key to move the multi-segment line to the left or to the right. Use the numeric keys to input value. Press one of the unit soft keys.</p> |
| <p>[Save/Recall]</p> | <p>Press the Save/Recall soft key to save the current setting as a file or to retrieve an existing setting.</p> |
| <p>[Channel Limit]</p> | <p>Press the Channel Limit soft key to set channel limit for a selected channel.</p> |
| <p>[Table] <On> or <Off></p> | <p>Press the Table soft key and toggle this key to show or hide the channel index table on the display screen.</p> |
| <p>[Index] Enter a value [Enter] or ENTER</p> | <p>Press the Index soft key to select an index to be set. Use the numeric keys to input value between 1 and 10. Press the Enter soft key or the ENTER hard key.</p> |
| <p>[Start Frequency] Enter a value [GHz], [MHz], [kHz], or [Hz]</p> | <p>Press the Start Frequency or Center Frequency soft key depending on prior frequency setting. Use the numeric keys to input value. Press one of the unit soft keys to complete the input.</p> |
| <p>[Stop Frequency] Enter a value [GHz], [MHz], [kHz], or [Hz]</p> | <p>Press the Stop Frequency soft key or Span Frequency soft key depending on prior frequency setting. Use the numeric keys to input value. Press one of the unit soft keys to complete the input.</p> |
| <p>[High Limit] Enter a value [dBm] or ENTER</p> | <p>Press the High Limit soft key. Use the numeric keys to input value. Press the unit soft key or the ENTER hard key.</p> |
| <p>[Low Limit] Enter a value [dBm] or ENTER</p> | <p>Press the Low Limit soft key. Use the numeric keys to input value. Press the unit soft key or the ENTER hard key.</p> |
| <p>[Limit] <On> or <Off></p> | <p>Press the Limit soft key and toggle this key between On and Off to enable or disable channel power limit on the display screen.</p> |

- n **DISPLAY LINE:** Enables or disables the display line on the screen that activates an adjustable horizontal line that is used as a visual reference line. Toggle the **Display Line** soft key to select it to **On** or **Off**. Use the numeric keys to set the line value.
- n **MULTI SEGMENT LINE:** Sets multi-segment line(s).
 - Y **AUTO SET:** Sets the segment line limit automatically.
 - Y **LIMIT:** Sets the pass/fail criteria upper or lower segment limit. Toggle this key between **Upper** and **Lower**.
 - Y **LIMIT:** Enables or disables the upper or lower segment line on the display screen. Toggle this key between **On** and **Off**.
 - Y **# OF LINE:** Sets segment line numbers to be used. Use the numeric keys to input value between 1 and 25 and then press the **Enter** soft key or the **ENTER** hard key.
 - Y **EDIT LIMIT:** Edits segment line(s) properties.
 - **LINE:** Shows or hides a segment line. Toggle this key between **On** and **Off**.
 - **FREQUENCY/DISTANCE:** Sets the frequency of the segment line. Use the numeric keys to input value and then press one of the unit soft keys to complete the input.
 - **AMPLITUDE:** Sets the amplitude of the segment line. Use the numeric keys to input value and then press the unit soft key or the **ENTER** hard key.
 - **ADD POINT:** Adds a point on the right-hand side of the active point.
 - **DELETE POINT:** Deletes the active point.
 - **MOVE POINT LEFT:** Selects a point next to the left as an active point.
 - **MOVE POINT RIGHT:** Selects a point next to the right as an active point.
 - Y **MOVE LIMIT:** Moves the segment line limit.
 - **LIMIT UP/DOWN:** Moves the multi-segment line upward or downward. Use the numeric keys to input value and then press the **dB** unit soft key or the **ENTER** hard key.
 - **LIMIT LEFT/RIGHT:** Moves the multi-segment line to the left or to the right. Use the numeric keys to input value and then press one of the unit soft keys.
 - Y **SAVE/RECALL:** Saves the current setting as a file or retrieves an existing setting.
- n **CHANNEL LIMIT:** Sets channel limit.
 - Y **TABLE:** Shows or hides the channel table on the display screen. Toggle this key between **On** and **Off**.
 - Y **INDEX:** Selects a channel index number to be set or displayed. Use the numeric keys to input value and then press the **Enter** soft key or the **ENTER** hard key.

- Y **START FREQUENCY:** Sets the start frequency for a selected index. Use the numeric keys to input value and then press one of the unit soft keys. Depending on prior frequency setting, this key is interchanged with center frequency.
- Y **STOP FREQUENCY:** Sets the span frequency for a selected index. Use the numeric keys to input value and then press one of the unit soft keys. Depending on prior frequency setting, this key is interchanged with span frequency.
- Y **HIGH LIMIT:** Sets the upper threshold of pass/fail indicator. Use the numeric keys to input value and then press the unit soft key or the **ENTER** hard key.
- Y **LOW LIMIT:** Sets the lower threshold of pass/fail indicator. Use the numeric keys to input value and then press the unit soft key or the **ENTER** hard key.
- Y **LIMIT:** Enables or disables channel power limit on the display screen. Toggle this key between **On** and **Off**.

SOUND INDICATOR

The Sound Indicator in the Interference Analyzer mode is used to help the user to identify interfering signals by sound alarm.

Measurement Procedure

| Step | Description |
|--|--|
| 1. Select the measurement mode MEASURE [Spectrum] | Press the MEASURE hot key. Press the Spectrum soft key. (Spectrum mode is set by default.) |
| 2. Set the measurement parameters MEASURE SETUP [Sound Indicator] [Sound] <On> or <Off> [Alarm Reference] <Marker> or <Line> | Press the MEASURE SETUP hot key. Press the Sound Indicator soft key. Press the Sound soft key to set it on or off. Toggle between On and Off . Press the Alarm Reference soft key. Toggle between Marker and Line to select the alarm reference type. |

| | |
|---|--|
| <p>[Limit Line]</p> <p>Enter a value</p> <p>[dBm] or [ENTER]</p> | <p>Press the Limit Line soft key. This soft key is activated when the Line is selected as the alarm reference type.</p> <p>Use the numeric keys to input value.</p> <p>Press the unit soft key or the ENTER hard key to complete the input.</p> |
| <p>[Volume]</p> <p>Enter a value</p> <p>[ENTER]</p> | <p>Press the Volume soft key.</p> <p>Use the numeric keys to input value.</p> <p>Press the ENTER hard key to complete the input.</p> |
| <p>[Auto Save]</p> <p><On> or <Off></p> | <p>Press the Auto Save soft key to set it on or off.</p> <p>Toggle between On and Off.</p> |

MEASURE SETUP



- n **SOUND INDICATOR:** Sets the sound indicator parameters.
 - Y **SOUND:** Turns the alarm sound on or off by toggling this soft key between **On** and **Off**.
 - Y **ALARM REFERENCE:** Selects the alarm reference type. Toggle this soft key to select **Marker** or **Line**.
 - Y **LIMIT LINE:** Sets the threshold limit for the alarm sound. Use the rotary knob and the arrow keys or the numeric keys and then the unit soft key. This soft key is activated when the **Line** is selected as the alarm reference type.
 - Y **VOLUME:** Sets the speaker volume. Use the rotary knob and arrow keys to adjust the volume. Or use the numeric keys and then press the **Enter** soft key.
- n **AUTO SAVE:** Enables or disables automatic saving of the measurement data to an external USB memory. When this key is set to On, there pops up the screen keyboard. Use the arrow keys or the rotary knob to give a file name to the data to be saved and then press the **Done** soft key to start saving. The display screen will show the word Recording in red color to indicate that the instrument is saving data. Saved measurement data can be loaded and replayed in the Spectrum Replayer menu.

NOTE: The USB device should not be removed during any of recording or replaying, Taking the device out may freeze the USB port and system restart is needed to get a USB device recognized again.

AM/FM AUDIO DEMODULATION

The AM/FM Audio Demodulation is used to help the user to identify if the interfering signal is nth harmonics of AM/FM audio.

Measurement Procedure

| Step | Description |
|---|---|
| 1. Select the measurement mode MEASURE [Spectrum] | Press the MEASURE hot key. Press the Spectrum soft key. (Spectrum mode is set by default.) |
| 2. Set the measurement parameters MEASURE SETUP [AM/FM Audio Demod] [Audio Demod] <On> or <Off> [Demod at] [M1], [M2], [M3], [M4], [M5], or [M6], [Demod Mode] <AM>, <FM>, or <CW> [Dwell Time] Enter a value [Min] or [Sec] [Volume] Enter a value [Enter] [Auto Gain] <On> or <Off> [Auto Save] <On> or <Off> | Press the MEASURE SETUP hot key. Press the AM/FM Audio Demod soft key. Press the Audio Demod soft key to turn it on or off. Toggle between On and Off . Press the Demod at soft key. Press one of the marker soft keys to select the marker (M1 to M6) at the frequency to be demodulated. Press the Demod Mode soft key to select the mode. Toggle among AM , FM and CW . Press the Dwell Time soft key to set demodulation interval. Use the rotary knob and arrow keys or use the numeric keys and the unit soft key. Press the Volume soft key to set the speaker volume. Use the rotary knob and arrow keys or use the numeric keys and the Enter soft key. Press the Auto Gain soft key to turn it on or off. Toggle between On and Off . Press the Auto Save soft key to set it on or off. Toggle between On and Off . |

MEASURE SETUP



- n **AM/FM AUDIO DEMOD:** Sets the AM/FM audio demodulation parameter.
- Y **AUDIO DEMOD:** Turns the AM/FM demodulator sound on or off by toggling this soft key

between **On** and **Off**.

- Y **DEMODO AT:** Sets the marker at the frequency to be demodulated. The AM/FM demodulator uses the marker position as where to demodulate. The 6 markers from **M1** to **M6** are available in different frequencies and the user can select the frequency to be demodulated among them.
- Y **DEMODO MODE:** Selects **AM**, **FM** or **CW** tone to be demodulated. Every time the **Demod Mode** soft key is pressed, the selection moves.
- Y **DWELL TIME:** Sets the interval of demodulation or the period of time that the AM/FM demodulator demodulates. Use the rotary knob and arrow keys to change the value. Or use the numeric keys and then press the unit soft key.
- Y **VOLUME:** Sets the speaker volume. Use the rotary knob and arrow keys to adjust the volume. Or use the numeric keys and then press the **Enter** soft key.
- Y **AUTO GAIN:** Turns the Auto Gain mode on or off. The Auto Gain is used to adjust internal gain of the demodulator.

n **AUTO SAVE:** Enables or disables automatic saving of the measurement data to an external USB memory. When this key is set to On, there pops up the screen keyboard. Use the arrow keys or the rotary knob to give a file name to the data to be saved and then press the **Done** soft key to start saving. The display screen will show the word Recording in red color to indicate that the instrument is saving data. Saved measurement data can be loaded and replayed in the Spectrum Replayer menu.

NOTE: NOTE: The USB device should not be removed during any of recording or replaying, Taking the device out may freeze the USB port and system restart is needed to get a USB device recognized again.

INTERFERENCE ID

The Interference ID in the Interference Analyzer mode is used to help the user to find interfering signals over a designated spectrum and show a list of possible signal types for a selected signal.

Measurement Procedure

| Step | Description |
|---|---|
| 1. Select the measurement mode MEASURE [Spectrum] | Press the MEASURE hot key. Press the Spectrum soft key. (Spectrum mode is set by default.) |

| | |
|--|--|
| <p>2. Set the measurement parameters</p> <p>MEASURE SETUP</p> <p>[Interference ID] [Interference ID] <On> or <Off></p> <p>[Threshold] Enter a value [dBm] or [ENTER]</p> <p>[Measure Scope] Enter a value [MHz] or [ENTER]</p> <p>[Auto Save] <On> or <Off></p> | <p>Press the MEASURE SETUP hot key.</p> <p>Press the Interference ID soft key.</p> <p>Press the Interference ID soft key to turn it on or off.</p> <p>Toggle between On and Off.</p> <p>Press the Threshold soft key.</p> <p>Use the rotary knob or arrow keys or use the numeric keys and then press the unit soft key or the ENTER hard key.</p> <p>Press the Measure Scope soft key.</p> <p>Use the numeric keys to input value.</p> <p>Press the unit soft key or the ENTER hard key to complete the input.</p> <p>Press the Auto Save soft key to set it on or off.</p> <p>Toggle between On and Off.</p> |
|--|--|

MEASURE SETUP



- n **INTERFERENCE ID:** Sets the interference ID parameters.
 - Y **INTERFERENCE ID:** Enables or disables the interference ID and the limit line on the display screen by toggling this soft key between **On** and **Off**.
 - Y **THRESHOLD:** Sets the threshold level manually. Use the rotary knob and arrow keys to change the threshold value. Or use the numeric keys to input value and then press the unit soft key. The threshold input should be within the graticule range to show the limit line on the display.
 - Y **MEASURE SCOPE:** Sets the scope of the measurement in MHz. Use the numeric keys to input value and then press the unit soft key to complete the input.

- n **AUTO SAVE:** Enables or disables automatic saving of the measurement data to an external USB memory. When this key is set to On, there pops up the screen keyboard. Use the arrow keys or the rotary knob to give a file name to the data to be saved and then press the **Done** soft key to start saving. The display screen will show the word Recording in red color to indicate that the instrument is saving data. Saved measurement data can be loaded and replayed in the Spectrum Replayer menu.

NOTE: The USB device should not be removed during any of recording or replaying, Taking the device out may freeze the USB port and system restart is needed to get a USB device recognized again.

Measurement Example

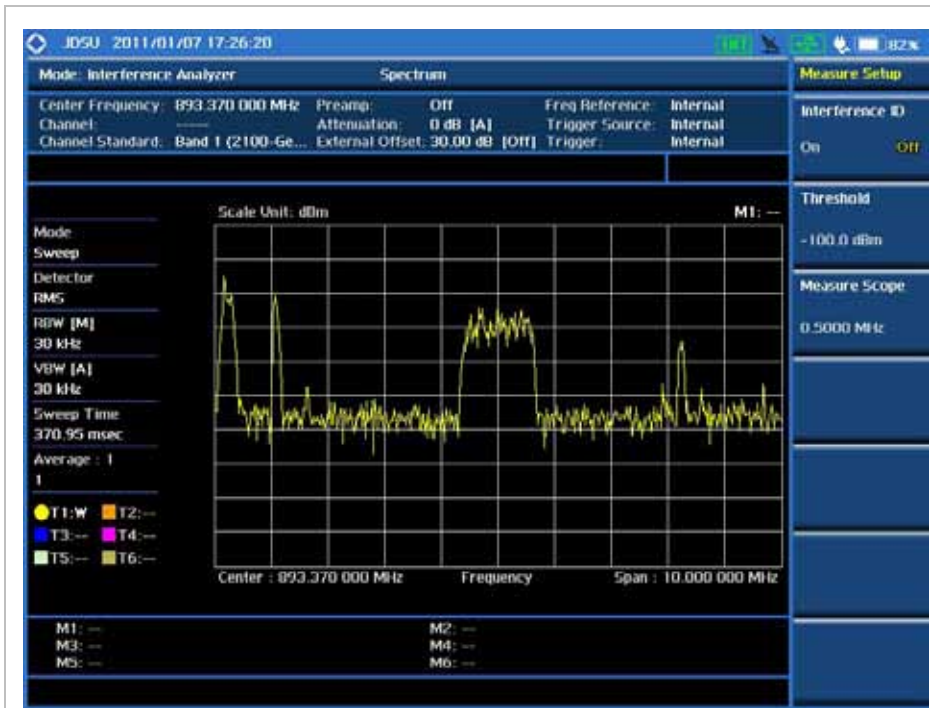

Interference Spectrum Measurement Screen without Interference ID

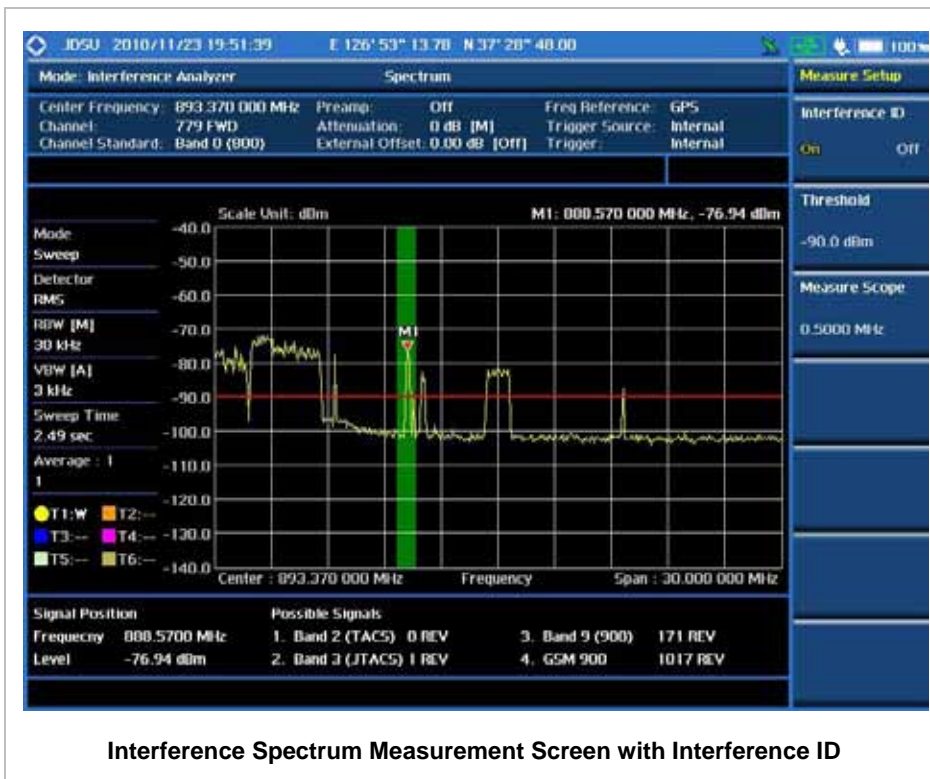

Interference Spectrum Measurement Screen with Interference ID

INTERFERENCE MEASUREMENTS

Interference Measurements in the Interference Analyzer mode provide the following essential measurements.

- n Spectrogram
- n RSSI (Received Signal Strength Indicator)
- n Interference Finder

Setting Mode

| Step | Description |
|---|---|
| 1. Connect antennas | Connect antennas as shown in the Connection Diagram on page 7 of this chapter. |
| 2. Select the mode MODE [Interference Analyzer] [Spectrogram], [RSSI], or [Interference Finder] | Press the MODE hard key. Press the Interference Analyzer soft key. Press one of the measurement mode soft keys to select. |

Setting Frequency

| Step | Description |
|--|--|
| 1. Set the frequency FREQ/DIST [Unit] <Freq> or <Channel> | Press the FREQ/DIST hard key. Press the Unit soft key. Toggle this key between Freq and Channel . A set of Freq/Dist screen menu changes accordingly. |
| <u>When Freq is selected:</u> [Center Frequency] Enter a value [GHz], [MHz], [kHz], or [Hz] | Press the Center Frequency soft key. Use the rotary knob or the arrow keys. Or use the numeric keys to input value and then press one of the unit soft keys to complete the input. |
| [Span] [Span], [Full Span], | Press the Span soft key in the Freq/Dist menu bar. Press one of the soft keys to select. When the Span is |

| | |
|--|---|
| <p>[Zero Span], or [Last Span] Enter a value [GHz], [MHz], [kHz], or [Hz]</p> | <p>selected, use the rotary knob or the arrow keys to change value. Or use the numeric keys to input value and then press one of the unit soft keys to complete the input.</p> |
| <p>or</p> | |
| <p>[Start Frequency] Enter a value [GHz], [MHz], [kHz], or [Hz]</p> | <p>Press the Start Frequency soft key. Use the rotary knob or the arrow keys. Or use the numeric keys to input value and then press one of the unit soft keys to complete the input.</p> |
| <p>[Stop Frequency] Enter a value [GHz], [MHz], [kHz], or [Hz]</p> | <p>Press the Stop Frequency soft key. Use the rotary knob or the arrow keys. Or use the numeric keys to input value and then press one of the unit soft keys to complete the input.</p> |
| <p><i>When Channel is selected:</i></p> | |
| <p>[Channel Standard] Select a band</p> | <p>Press the Channel Standard soft key. Select a band to be measured by using the rotary knob, the arrow keys, or Page Up/Page Down soft keys. Press the Select soft key to confirm the selection.</p> |
| <p>[Channel Number] Enter a value [Enter] or ENTER</p> | <p>Press the Channel Number soft key. Use the numeric keys to input value and press the Enter soft key or ENTER hard key to complete the input. The instrument automatically displays its corresponding center frequency value for the channel number.</p> |
| <p>[Span] [Span], [Full Span], [Zero Span], or [Last Span] Enter a value [GHz], [MHz], [kHz], or [Hz]</p> | <p>Press the Span soft key in the Freq/Dist menu bar. Press one of the soft keys to select. When the Span is selected, use the rotary knob or the arrow keys to change value. Or use the numeric keys to input value and then press one of the unit soft keys to complete the input.</p> |
| <p>[Link] <FWD> or <REV></p> | <p>Press the Link soft key to set the link direction. Toggle this key between FWD and REV.</p> |

FREQ/DIST



There are three ways to set the frequency band: center frequency/span, start frequency/stop frequency, and channel number/span.

- n **UNIT:** Determines the way how to set the frequency band either with standard band or custom frequency band. Toggling this key between **Freq** and **Channel** changes a set of Freq/Dist screen menu automatically.

When the unit is set to Frequency:

- n **CENTER FREQUENCY:** Changes the center frequency setting in the spectrum measurement. Use the rotary knob or the arrow keys. Or use the numeric keys to input a certain value and press one of the unit soft keys to complete the input.
- n **SPAN:** Sets the frequency range over which the instrument will sweep.
- n **START FREQUENCY:** Changes the start frequency in the spectrum measurement. Use the rotary knob or the arrow keys. Or use the numeric keys to input a certain value and press one of the unit soft keys to complete the input.
- n **STOP FREQUENCY:** Changes the stop frequency in the spectrum measurement. Use the rotary knob or the arrow keys. Or use the numeric keys to input a certain value and press one of the unit soft keys to complete the input.
- n **FREQUENCY STEP:** Defines the amount of frequency to be increased or decreased when using the rotary knob or the arrow keys to change the **Center Frequency**, **Start Frequency**, or **Stop Frequency**. This frequency step size can be entered by using numeric keys and the unit soft keys.

When the unit is set to Channel:

- n **CHANNEL NUMBER:** Enters a channel number. The instrument automatically displays its corresponding center frequency value for the channel number.
- n **SPAN:** Sets the frequency range over which the instrument will sweep.
- n **CHANNEL STEP:** Defines the amount of channel to be increased or decreased when using the rotary knob or the arrow keys to change the **Channel Number**. This channel step size can be entered by using numeric keys and the **Enter** soft key.
- n **LINK:** Sets the direction of sweeping. Toggle this key between **FWD** and **REV**.
- n **CHANNEL STANDARD:** When the channel standard is selected from the list, the center frequency information on the display screen will be mapped accordingly to the selected channel standard. The channel standards available in the instrument are listed in the Appendix C – Band, Frequency & Channel Standard.

Setting Amplitude

| Step | Description |
|---|--|
| 1. Set the reference/attenuation level AMP/SCALE [Auto Scale] or | Press the AMP/SCALE hard key. Press the Auto Scale soft key to automatically set optimum levels of reference and attenuation. |

| | |
|--|---|
| <p>[Reference Level] Enter a reference level value</p> | <p>Press the Reference Level soft key to set manually. Use the numeric keys or the rotary knob that changes in a 10 dB step.</p> |
| <p>[dBm] or ENTER</p> | <p>Press the dBm soft key or the ENTER hard key.</p> |
| <p>[Attenuation] <Manual> Enter an attenuation value</p> | <p>Press the Attenuation soft key. The Auto mode is set by default. This key toggles between the Auto and Manual. Press the Attenuation soft key to highlight the Manual mode and change the attenuation value to optimize S/N. Use the numeric keys or the rotary knob that changes in a 5 dB step. The attenuation setting range is 0 to 50 dB.</p> |

AMP/SCALE



- n **AUTO SCALE:** The instrument can automatically set the scale to the minimum and maximum values on the Y-axis of the graph for optimum display of the traces measured. Each time the **Auto Scale** is selected, the top and bottom scales are set to the minimum and maximum values with margin on the Y-axis of the display screen.
- n **REFERENCE LEVEL:** Sets the maximum Y-axis range.
- n **SCALE/DIV:** Is used only for the Spectrum measurement screen. It represents the value of one division on the horizontal scale. The default value is 10 dB per division and the Y-Scale is set to 100 dB. Selecting the **Scale/Div** soft key enables to set the value to 1 dB per division with the numeric keys or the rotary knob.
- n **ATTENUATION**
 - Y **AUTO:** Input attenuator's value is automatically set depending on the reference level. This is the default operation mode, so it is recommended to use this mode unless a special measurement condition is needed.
 - Y **MANUAL:** Sets the attenuator's value for the **Spectrum Analyzer RF In 50 Ω** port.
- n **PREAMP:** Turns on or off the internal pre-amplifier. Preamp results in a correction being applied to compensate for the gain of the preamp so that amplitude readings show the value at the input connector. This soft key toggles between the **On** and **Off**. When it is set to On, the allowable attenuation input range is from 0 dB to 10 dB in a multiple of 5. If the attenuation value is manually set greater than 10 dB, the instrument will automatically turn off the pre-amplifier to display low level signal properly on the screen.
- n **UNITS:** Sets the scale unit on the display among **dBm**, **dBV**, **dBmV**, **dBuV**, **V**, and **W**.
- n **EXTERNAL OFFSET:** Sets an external offset value. An offset consists of a cable loss and a user offset and the measurement result shows the value reflecting both offset values. When the external offset value is set at 40 dB in the Spectrum mode, the measurement result compensates

40 dB at both the Spectrum Analyzer and Signal Analyzer modes.

Setting Bandwidth

| Step | Description |
|--|---|
| 1. Set the bandwidth BW/AVG [RBW] Enter RBW value [MHz], [kHz], or [Hz] [VBW] Enter VBW value [MHz] or [kHz] or [Hz] [VBW/RBW] <1>, <0.3>, <0.1>, <0.03>, <0.01>, or <0.003> | Press the BW/AVG hard key. Press the RBW soft key. Use the numeric keys and the unit soft keys or the rotary knob. Press the VBW soft key. Use the numeric keys and the unit soft keys or the rotary knob. Press the VBW/RBW soft key. Each time the key is pressed the selection changes in sequence from 1 to 0.003. |

BW/AVG



- n **RBW:** Sets the Resolution Bandwidth (RBW) of the Spectrum Analyzer. Toggles between the **Auto** and **Manual**. When the **Auto** is selected, the RBW is selected based on the frequency span. When the **Manual** is selected, the RBW can be set from 1 Hz to 3 MHz in a 1-3 sequence using the numeric keys, the arrow keys, or the rotary knob.
- n **VBW:** Sets the Video Bandwidth (VBW) of the Spectrum Analyzer. Toggles between the **Auto** and **Manual**. When the **Auto** is selected, the VBW is selected based on the current RBW and RBW/VBW settings.
- n **VBW/RBW:** Sets proportional VBW based on the designated RBW. Every time the VBW/RBW soft key is pressed the ration selection changes. For the user's better understanding of the rather complicated formula, this table shows the VBW setting in proportion to the VBW/RBW ratio at 30 kHz RBW setting as an example.

| RBW | VBW/RBW Ratio | VBW |
|--------|---------------|--------|
| 30 kHz | 1:1 | 30 kHz |
| | 1:0.3 | 10 kHz |
| | 1:0.1 | 3 kHz |
| | 1:0.03 | 1 kHz |
| | 1:0.01 | 300 Hz |
| | 1:0.003 | 100 Hz |

Setting Averaging

BW/AVG

- n **AVERAGE:** Sets the number of measurements to be averaged for the trace presentation. A maximum of 100 times of averaging can be set.

| Step | Description |
|---|---|
| 1. Set the averaging BW/AVG [Average] | Press the BW/AVG hard key. Press the Average soft key. |
| 2. Enter number of averaging to set | Use the numeric keys and input a number between 1 and 100. When the averaging reaches to the number set here, a new measurement value replaces the earliest measurement value in sequence. |
| 3. [Enter] or ENTER | Press the Enter soft key or the ENTER hard key. |

Setting Sweep**SWEEP**

This hot key is used to set and control the sweep parameters such as Sweep Time, Sweep Mode, Gated Sweep Settings and Gated Sweep On/Off. The user input window must be inactive first to get the Sweep hot key function other than the number input.

- n **SWEEP TIME:** Sets the sweep time automatically or manually by toggling this soft key between **Auto** and **Manual**. Use the numeric keys to input value manually and press one of the unit soft keys among **Sec**, **mSec**, and **uSec** to complete the input.
- n **SWEEP MODE:** Sets the sweep mode.

| Step | Description |
|--|--|
| 1. Set the sweep mode SWEEP [Sweep Mode] <Continue> or <Single> | Press the SWEEP hot key. Press the Sweep Mode soft key. Toggle this key between Continue and Single . |

- n **GATED SWEEP SETTINGS:** Sets the gated sweep parameters with internal trigger source. Pressing the Gated Sweep Settings automatically changes the measurement display from frequency domain to time domain. *This key is not available in the Spectrum Replayer mode.*

| Step | Description |
|-----------------------------------|-------------|
| 1. Set the gated sweep parameters | |

| | |
|--|--|
| <p>SWEEP</p> <p>[Gated Sweep Settings]</p> <p>[Period]</p> <p><StdSignal> or <Manual></p> <p>Enter a value</p> <p>[Sec], [mSec], or [uSec]</p> <p>[StdSignal]</p> <p>[GSM (4.615 ms)],</p> <p>[WCDMA (10 ms)],</p> <p>[LTE (10 ms)],</p> <p>[EV-DO (5 ms)],</p> <p>[TD-SCDMA (5 ms)], or</p> <p>[WiMAX (10 ms)]</p> | <p>Press the SWEEP hot key.</p> <p>Press the Gated Sweep Settings soft key.</p> <p>Press the Period soft key to select a standard signal or period manually. Toggle this key between StdSignal and Manual.</p> <p>Use the numeric keys to input value of period manually.</p> <p>Press one of the unit soft keys to select.</p> <p>Press the StdSignal to select a standard signal for the period. This soft key is activated when the StdSignal is selected for the Period setting above. Select one of the signal soft keys to choose.</p> |
| <p>2. Set the trigger</p> <p>TRIGGER</p> <p>[Video] or [Display Position]</p> <p>PREV</p> | <p>Press the TRIGGER hot key after setting the Period.</p> <p>Press the Video or Display Position soft key to set the trigger type.</p> <p>Press the PREV hard key in order to go back to the Gated Sweep Settings menu.</p> |
| <p>3. Continue setting the gated sweep parameters</p> <p>[Zero Span Time]</p> <p>Enter a value</p> <p>[Sec], [mSec], or [uSec]</p> <p>[Gate Delay]</p> <p>Enter a value</p> <p>[Sec], [mSec], or [uSec]</p> <p>[Gate Length]</p> <p>Enter a value</p> <p>[Sec], [mSec], or [uSec]</p> <p>PREV</p> | <p>Press the Zero Span Time soft key.</p> <p>Use the numeric keys to input value of sweep time.</p> <p>Press one of the unit soft keys to select.</p> <p>Press the Gate Delay soft key and then turn the rotary knob to change the gate delay gradually.</p> <p>Or use the numeric keys to input value of gate delay and then press one of the unit soft keys to complete the input.</p> <p>Press the Gate Length soft key and then turn the rotary knob to change the gate length gradually.</p> <p>Or use the numeric keys to input value of gate length and then press one of the unit soft keys to complete the input.</p> <p>Press the PREV hard key in order to go back to the Sweep menu and to start gated sweeping.</p> |

Y **ZERO SPAN TIME:** Sets the zero span sweep time manually.

Y **GATE DELAY:** Sets the gated sweep delay.

- Y **GATE LENGTH:** Sets the gated sweep length.
- Y **PERIOD:** Sets the period by selecting a standard signal from available choices or by manually entering a value.
- Y **STDSIGNAL:** Sets the type of standard signal used for the **Period** among **GSM (4.615 ms)**, **WCDMA (10 ms)**, **LTE (10 ms)**, **EV-DO (5 ms)**, **TD-SCDMA (5 ms)**, and **WiMAX (10 ms)**.
This soft key is activated when the **Period** setting is set to the **StdSignal**.
- n **GATED SWEEP:** Enables or disables gated sweep. *This key is not available in the Spectrum Replayer mode.*

Setting Limit



This hot key is used to set the threshold value for the display on the display screen. It turns on or off the display line. The user input window must be inactive first to get the Limit hot key function other than the number input.

| Step | Description |
|--|---|
| 1. Set the limit LIMIT [Display Line] <On> or <Off> Enter a value [dBm] or ENTER | Press the LIMIT hot key. Press the Display Line soft key to toggle between On and Off and select one. Use the numeric keys to input limit value. Press the unit soft key or the ENTER hard key. |

- n **DISPLAY LINE:** Enables or disables the display line on the screen that activates an adjustable horizontal line that is used as a visual reference line. Toggle the **Display Line** soft key to select it to **On** or **Off**. Use the numeric keys to set the line value.

SPECTROGRAM

The Spectrogram mode is particularly useful when attempting to locate an emitter using a directional antenna. When the directional antenna is used to receive the signal, the user will see a change in the amplitude of the tracked signal as the user changes the direction of the antenna and also see a change in the Spectrogram color. The source of the signal is located in the direction that results in the

highest signal strength.

This measurement is done at user defined frequency range. The power at a frequency (in dBm) is displayed along with a spectrogram in three-dimensional display.

- n The horizontal line or X-axis of the spectrogram is frequency.
- n The vertical line or Y-axis is time.
- n The color identification (spectrogram) indicates power level of the tracked signal. As the signal strength increases, the color on the spectrogram will change accordingly.

Measurement Procedure

| Step | Description |
|--|---|
| 1. Select the measurement mode MEASURE [Spectrogram] | Press the MEASURE hot key. Press the Spectrogram soft key. |
| 2. Set the measurement parameters MEASURE SETUP [Time Cursor] <On> or <Off> [Time Interval] Enter a value [Enter] or ENTER [Auto Save] <On> or <Off> | Press the MEASURE SETUP hot key. Press the Time Cursor soft key to set the indicator on the display screen. Toggle between On and Off . Press the Time Interval soft key. Use the numeric keys. Press the Enter soft key or the ENTER hard key. Press the Auto Save soft key to set it on or off. Toggle between On and Off . |

MEASURE SETUP



When the instrument is in the Spectrogram mode, following measurement parameters are available.

- n **RESET/RESTART:** Restarts the measurement.
- n **AUTO SAVE:** Enables or disables automatic saving of the measurement data to an external USB memory. When this key is set to On, there pops up the screen keyboard. Use the arrow keys or the rotary knob to give a file name to the data to be saved and then press the **Done** soft key to start saving. The display screen will show the word Recording in red color to indicate that the instrument is saving data. Saved measurement data can be loaded and replayed in the Spectrum

Replayer menu.

NOTE: The USB device should not be removed during any of recording or replaying, Taking the device out may freeze the USB port and system restart is needed to get a USB device recognized again.

- n **TIME CURSOR:** Enables or disables the time cursor indicator. Sets the time cursor indicator from 1 to 400. When the time cursor is enabled after specifying a number, measurement is put on hold and information of the specific number is updated on the measurement screen.
- n **TIME INTERVAL:** Sets the time interval in second. Use the numeric keys to enter a value and press the **Enter** soft key or the **ENTER** hard key to complete to the input. 0 is the fastest measurement speed. As the time interval gets larger, the measurement speed is reduced.

Measurement Example

The spectrogram shows a vertical line on the chart when the marker is enabled on the screen.

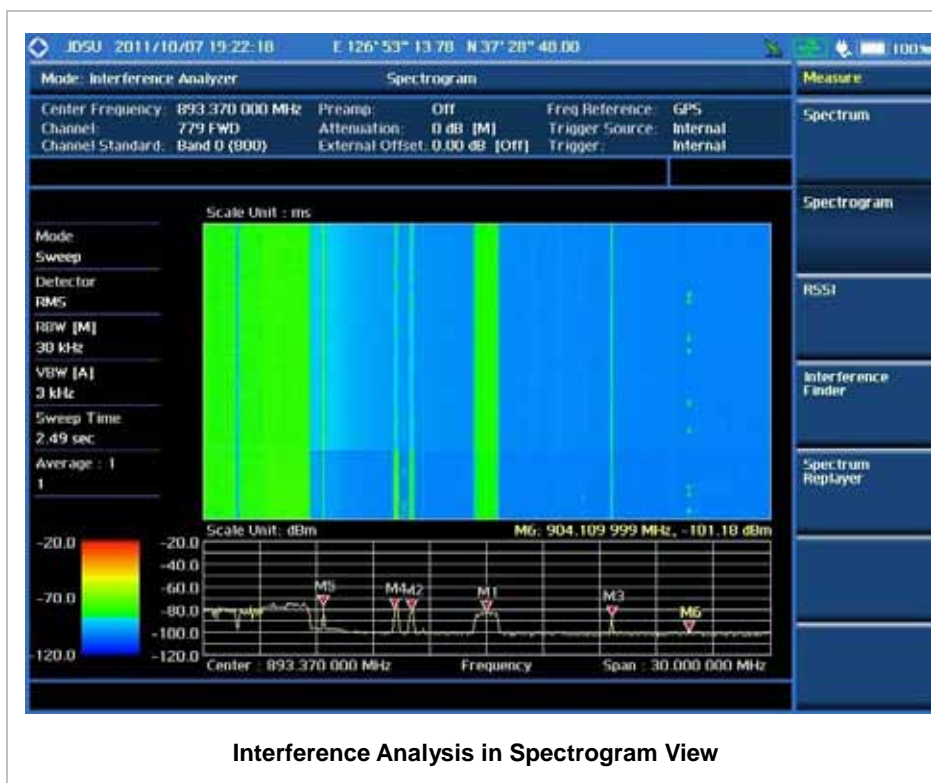

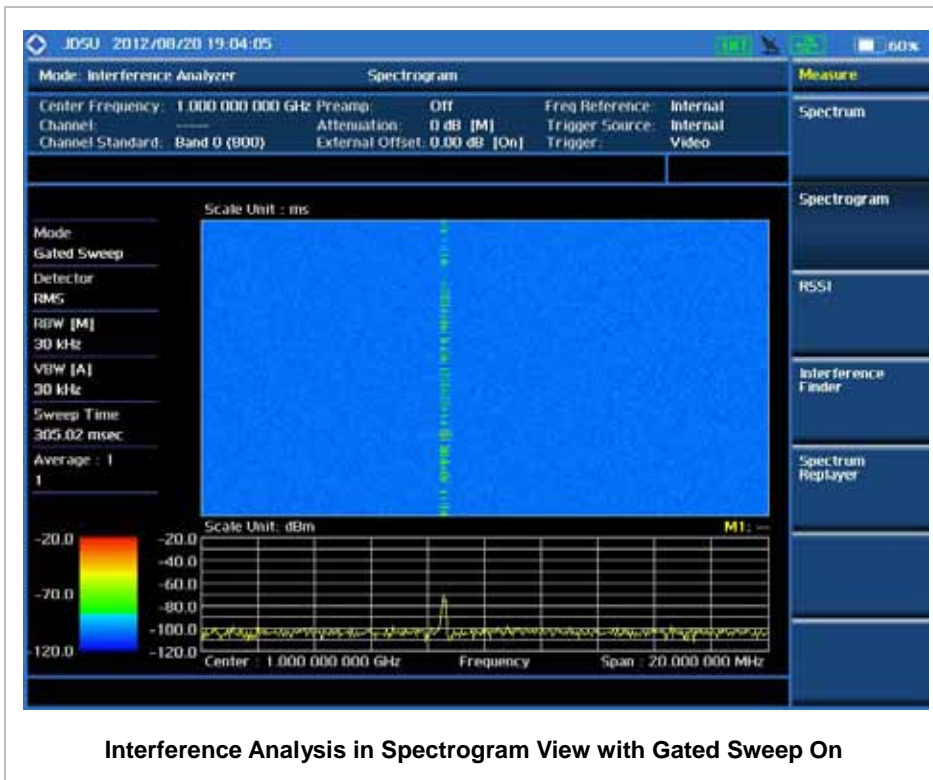

RSSI

In the Received Signal Strength Indicator (RSSI) mode, the user can track the identified signals in more details with the markers (6 different frequency components are available in one display). This will provide the power components and power variations on those set frequencies over time.

Measurement Procedure

| Step | Description |
|---|--|
| 1. Select the measurement mode MEASURE [RSSI] | Press the MEASURE hot key. Press the RSSI soft key. |
| 2. Set the measurement parameters MEASURE SETUP [Alarm] [Alarm] <On> or <Off> [Alarm at] [M1], [M2], [M3], [M4], | Press the MEASURE SETUP hot key. Press the Alarm soft key. Press the Alarm soft key to turn it on or off. Toggle between On and Off . Press the Alarm at soft key. Press one of the marker soft keys to select the marker (M1 |

| | |
|--|--|
| <p>[M5], or [M6], [Limit Line] Enter a value [dBm] or [ENTER]</p> | <p>to M6) at the frequency to be alarmed. Press the Limit Line soft key. Use the numeric keys to input value. Press the unit soft key or the ENTER hard key to complete the input.</p> |
| <p>[Volume] Enter a value [ENTER]</p> | <p>Press the Volume soft key. Use the numeric keys to input value. Press the ENTER hard key to complete the input.</p> |
| <p>[AM/FM Audio Demod] [Audio Demod] <On> or <Off></p> | <p>Press the AM/FM Audio Demod soft key. Press the Audio Demod soft key to turn it on or off. Toggle between On and Off.</p> |
| <p>[Demod at] [M1], [M2], [M3], [M4], [M5], or [M6],</p> | <p>Press the Demod at soft key. Press one of the marker soft keys to select the marker (M1 to M6) at the frequency to be demodulated.</p> |
| <p>[Demod Mode] <AM>, <FM>, or <CW></p> | <p>Press the Demod Mode soft key to select the mode. Toggle among AM, FM and CW.</p> |
| <p>[Dwell Time] Enter a value [Min] or [Sec]</p> | <p>Press the Dwell Time soft key to set demodulation interval. Use the rotary knob and arrow keys or use the numeric keys and the unit soft key.</p> |
| <p>[Volume] Enter a value [Enter]</p> | <p>Press the Volume soft key to set the speaker volume. Use the rotary knob and arrow keys or use the numeric keys and the Enter soft key.</p> |
| <p>[Auto Gain] <On> or <Off></p> | <p>Press the Auto Gain soft key to turn it on or off. Toggle between On and Off.</p> |
| <p>[Auto Save] <On> or <Off></p> | <p>Press the Auto Save soft key to set it on or off. Toggle between On and Off.</p> |

MEASURE SETUP



When the instrument is in the RSSI mode, following measurement parameters are available.

- n **RESET/RESTART:** Restarts the measurement.
- n **AUTO SAVE:** Enables or disables automatic saving of the measurement data to an external USB memory. When this key is set to On, there pops up the screen keyboard. Use the arrow keys or the rotary knob to give a file name to the data to be saved and then press the **Done** soft key to start saving. The display screen will show the word Recording in red color to indicate that the instrument is saving data. Saved measurement data can be loaded and replayed in the Spectrum Replayer menu.

NOTE: The USB device should not be removed during any of recording or replaying, Taking the device out may freeze the USB port and system restart is needed to get a USB device recognized

again.

- n **ALARM:** Sets the alarm parameters.
 - Y **ALARM:** Turns the alarm sound on or off by toggling this soft key between **On** and **Off**.
 - Y **ALARM AT:** Selects the marker(s) up to 6 different frequencies.
 - Y **LIMIT LINE:** Sets the threshold limit for the alarm sound. Use the rotary knob and the arrow keys or the numeric keys and then the unit soft key.
 - Y **VOLUME:** Sets the speaker volume. Use the rotary knob and arrow keys to adjust the volume. Or use the numeric keys and then press the **Enter** soft key.
- n **AM/FM AUDIO DEMOD:** Sets the AM/FM audio demodulation parameters to see if the interfering signal is n^{th} harmonics of AM/FM audio.
 - Y **AUDIO DEMOD:** Turns the AM/FM demodulator sound on or off by toggling this soft key between **On** and **Off**.
 - Y **DEMOD AT:** Sets the marker at the frequency to be demodulated. The AM/FM demodulator uses the marker position as where to demodulate. The 6 markers from **M1** to **M6** are available in different frequencies and the user can select the frequency to be demodulated among them.
 - Y **DEMOD MODE:** Selects **AM**, **FM** or **CW** tone to be demodulated. Every time the **Demod Mode** soft key is pressed, the selection moves.
 - Y **DWELL TIME:** Sets the interval of demodulation or the period of time that the AM/FM demodulator demodulates. Use the rotary knob and arrow keys to change the value. Or use the numeric keys and then press the unit soft key.
 - Y **VOLUME:** Sets the speaker volume. Use the rotary knob and arrow keys to adjust the volume. Or use the numeric keys and then press the **Enter** soft key.
 - Y **AUTO GAIN:** Turns the Auto Gain mode on or off. The Auto Gain is used to adjust internal gain of the demodulator.

Measurement Example

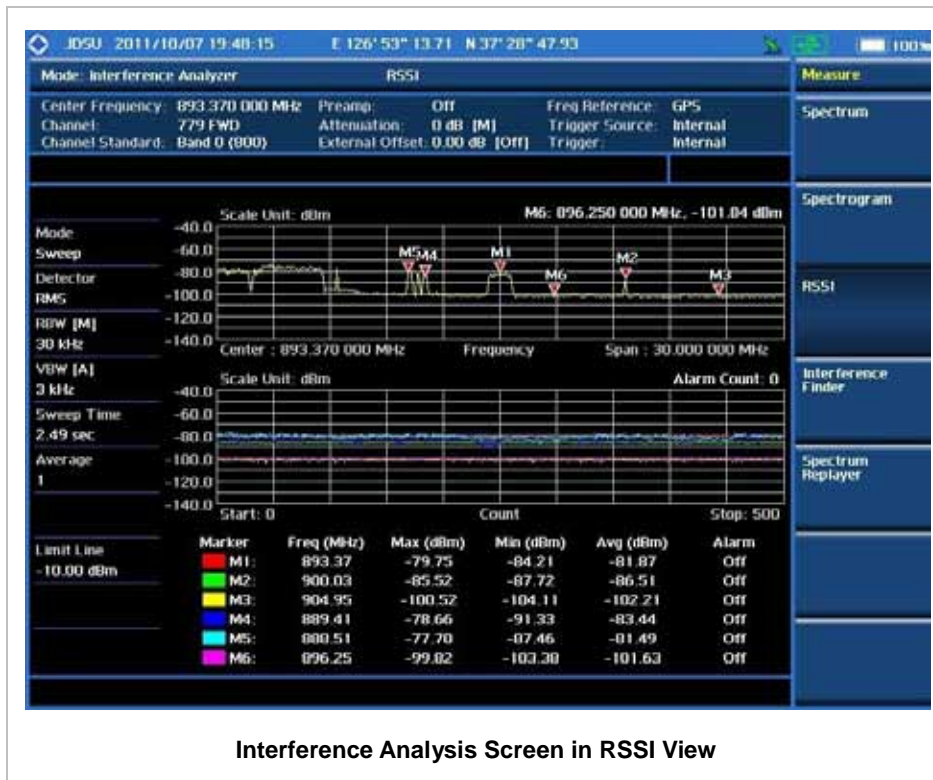

Interference Analysis Screen in RSSI View

INTERFERENCE FINDER

In the Interference Finder mode, triangulation is used to determine a possible location of interference signal by measuring angles to it from known points at either end of a fixed line using GPS position, rather than measuring distances to the point directly. The possible location of interference signal can then be estimated as the third point of a triangle with three known points and angles. Interference Finder calculates possible range of interference signal location using "Inscribed circle or Circumscribed circle" based on a triangle.

Here is an overview of how to find the possible location of interference signal.

Provide GPS antenna to get position information

Record position & azimuth of incoming signal using directional antenna (Yagi antenna). You can determine the position by enabling "Auto" after getting GPS locked

Repeat step 2 for Point 2 and Point 3

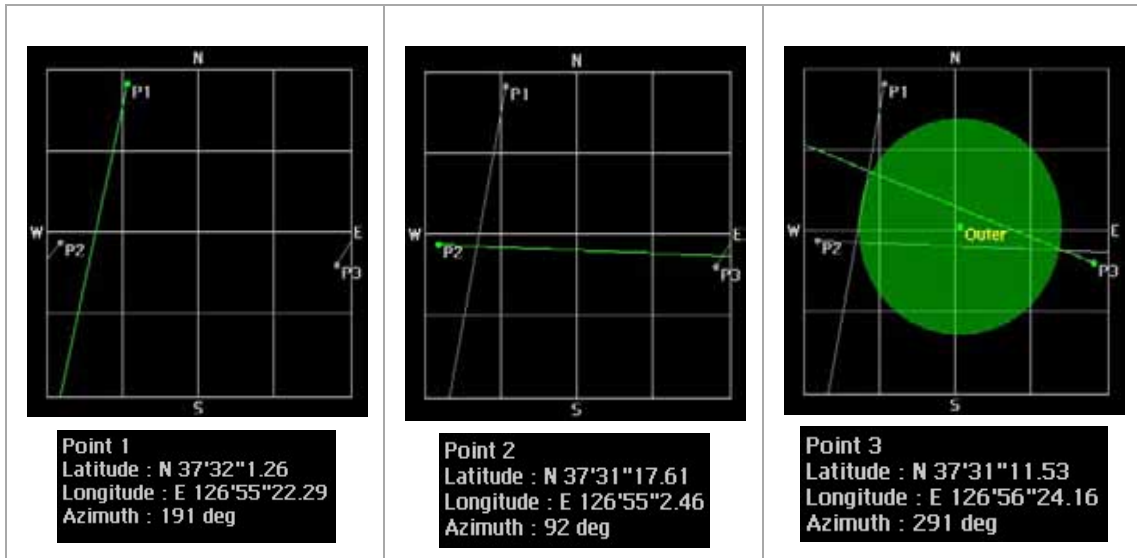

Check possible location of interference signal by changing it to a different display mode

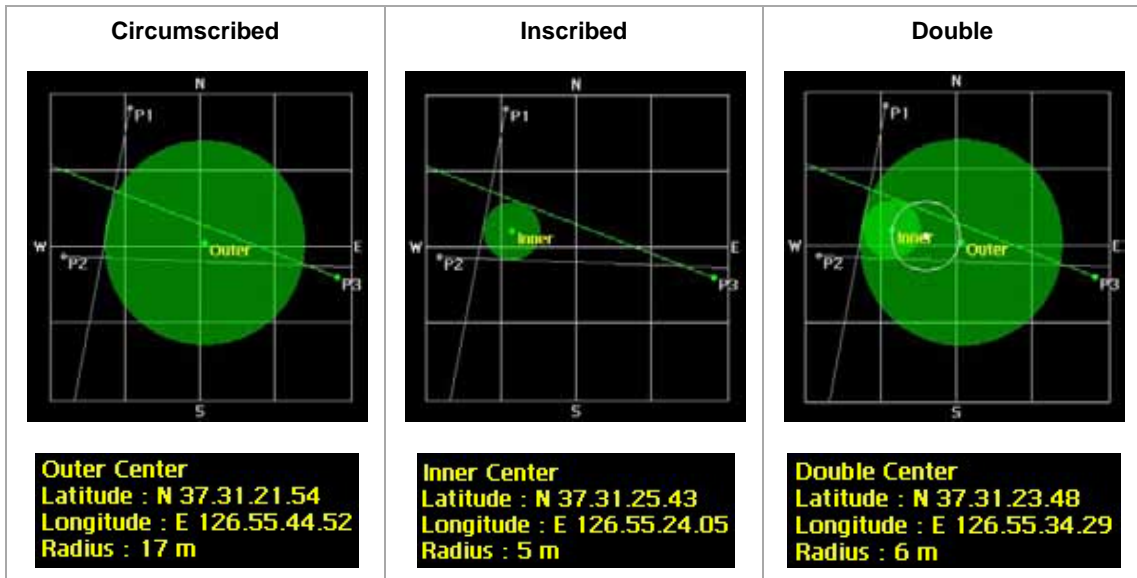

Measurement Procedure

| Step | Description |
|---|--|
| 1. Select the measurement mode MEASURE [Interference Finder] | Press the MEASURE hot key. Press the Interference Finder soft key. |
| 2. Set the measurement parameters MEASURE SETUP [Load Map] | Press the MEASURE SETUP hot key. Press the Load Map soft key to load a map file from a USB drive. |
| [Location] | Press the Location soft key. |

| | |
|---------------------------------|---|
| [Point1], [Point2], or [Point3] | Select a location point to be set. |
| [Get GPS Position] | Press the Get GPS Position soft key with GPS. |
| [Position] | Press the Position soft key to set manually. |
| [Latitude] | Press the Latitude soft key to set the latitude information of the selected point. |
| [NS] | Press the NS soft key to set it to North or South. Toggle this key between North and South . |
| <North> or <South> | |
| [Degree] | Press the Degree soft key. |
| Enter a value | Use the numeric keys to enter a value and then press the Enter soft key or the ENTER hard key to complete the input. |
| [Enter] or [ENTER] | |
| [Minute] | Press the Minute soft key. |
| Enter a value | Use the numeric keys to enter a value and then press the Enter soft key or the ENTER hard key to complete the input. |
| [Enter] or [ENTER] | |
| [Second] | Press the Second soft key. |
| Enter a value | Use the numeric keys to enter a value and then press the Enter soft key or the ENTER hard key to complete the input. |
| [Enter] or [ENTER] | |
| [Longitude] | Press the Longitude soft key to set the longitude information of the selected point. |
| [EW] | Press the EW soft key to set it to East or West. Toggle this key between East and West . |
| <East> or <West> | |
| [Degree] | Press the Degree soft key. |
| Enter a value | Use the numeric keys to enter a value and then press the Enter soft key or the ENTER hard key to complete the input. |
| [Enter] or [ENTER] | |
| [Minute] | Press the Minute soft key. |
| Enter a value | Use the numeric keys to enter a value and then press the Enter soft key or the ENTER hard key to complete the input. |
| [Enter] or [ENTER] | |
| [Second] | Press the Second soft key. |
| Enter a value | Use the numeric keys to enter a value and then press the Enter soft key or the ENTER hard key to complete the input. |
| [Enter] or [ENTER] | |
| [Azimuth] | Press the Azimuth soft key to set the azimuth of the selected point. |
| Enter a value | Use the rotary knob to align the straight line on the loaded map with the direction of the connected Yagi antenna. Or use the numeric keys to enter an azimuth using a compass. |

| | |
|---|---|
| [Enter] or [ENTER] | Press the center of the knob, the Enter soft key or the ENTER hard key to complete the input. |
| [Display Mode] <Circum>, <Inscribed>, or <Double> | Press the Display Mode soft key to set the display mode. Each time this key is pressed, the selection changes among Circum , Inscribed , and Double . |
| [Screen Mode] <Map> or <Full> | Press the Screen Mode soft key. Toggle this key between Map and Full . |

MEASURE SETUP



- n **LOAD MAP:** Loads a map file that is created in JMapCreator and saved in a USB drive.
- n **LOCATION:** Selects a location point in order to set its location information.
- n **GET GPS POSITION:** Gets the selected point's latitude and longitude information automatically when a GPS antenna is connected.
- n **POSITION:** Sets the selected point's information manually.
 - Y **LATITUDE:** Sets the latitude information of the selected point.
 - **NS:** Sets the direction to North or South. Toggle this key between **North** and **South**.
 - **DEGREE:** Sets the degree. Use the numeric keys to enter a value and then press the **Enter** soft key or the **ENTER** hard key to complete the input.
 - **MINUTE:** Sets the minute. Use the numeric keys to enter a value and then press the **Enter** soft key or the **ENTER** hard key to complete the input.
 - **SECOND:** Sets the minute. Use the numeric keys to enter a value and then press the **Enter** soft key or the **ENTER** hard key to complete the input.
 - Y **LONGITUDE:** Sets the longitude information of the selected point.
 - **EW:** Sets the direction to East or West. Toggle this key between **East** and **West**.
 - **DEGREE:** Sets the degree. Use the numeric keys to enter a value and then press the **Enter** soft key or the **ENTER** hard key to complete the input.
 - **MINUTE:** Sets the minute. Use the numeric keys to enter a value and then press the **Enter** soft key or the **ENTER** hard key to complete the input.
 - **SECOND:** Sets the minute. Use the numeric keys to enter a value and then press the **Enter** soft key or the **ENTER** hard key to complete the input.
- n **AZIMUTH:** Sets the azimuth of the selected point. Rotating the knob eliminates the need of a compass to find an azimuth and enables the user simply align the straight line on the loaded map

with the direction of the connected Yagi antenna.

- n **DISPLAY MODE:** Sets the display mode. Each time this key is pressed, the selection changes among **Circum**, **Inscribed**, and **Double**.
- n **SCREEN MODE:** Selects either **Map** or **Full**.
 - Y **MAP:** Displays points on the loaded map.
 - Y **FULL:** Displays points without the map.

Measurement Example



Interference Finder Measurement Screen (Map View)

SPECTRUM REPLAYER

The Spectrum Replayer function is used to retrieve and replay recorded measurement data that are saved into an external USB device by using the Auto Save function.

Measurement Procedure

| Step | Description |
|--|---|
| <p>1. Select the measurement mode</p> <p>MEASURE</p> <p>[Spectrum Replayer]</p> | <p>Press the MEASURE hot key.</p> <p>Press the Spectrum Replayer soft key.</p> |
| <p>2. Set the measurement parameters</p> <p>MEASURE SETUP</p> <p>[Load File]</p> <p><On> or <Off></p> <p>[Replay Control]</p> <p>[Replay]</p> <p><Play> or <Pause></p> <p>[Replay Speed]</p> <p>[x1], [x2], [x3], or [x4]</p> <p>[Replay Direction]</p> <p><FWD> or <REV></p> <p>[Stop]</p> <p>[Jump to Fail Index]</p> <p>Enter a value</p> <p>[Enter] or [ENTER]</p> <p>[Display Mode]</p> <p>[Spectrum], [RSSI], or [Spectrogram]</p> <p>[Alarm]</p> <p>[Alarm]</p> <p><On> or <Off></p> <p>[Alarm at]</p> <p>[M1], [M2], [M3], [M4], [M5], or [M6],</p> <p>[Limit Line]</p> <p>Enter a value</p> | <p>Press the MEASURE SETUP hot key.</p> <p>After connecting a USB memory device, press the Load File soft key and toggle this key between On and Off to retrieve a measurement file to be replayed.</p> <p>After loading a file, press the Replay Control soft key to set replay parameters.</p> <p>Press the Replay soft key to start, pause, or continue replaying. Toggle this key between Play and Pause.</p> <p>Press the Replay Speed soft key to choose speed. Select one of the available speed options to apply.</p> <p>Press the Replay Direction soft key to select forward or reverse mode. Toggle this key between FWD and REV.</p> <p>Press the Stop soft key to stop replaying.</p> <p>Press the Jump to Fail Index soft key to move to a certain failure position and replay. Use the numeric keys to input value and then press the Enter soft key or the ENTER hard key to complete the input.</p> <p>Press the Display Mode soft key to choose a mode. Select one of the display mode options.</p> <p>Press the Alarm soft key to set alarm parameters. This key becomes activated when the RSSI is selected.</p> <p>Press the Alarm soft key to turn it on or off. Toggle this key between On and Off.</p> <p>Press the Alarm at soft key.</p> <p>Press one of the marker soft keys to select the marker (M1 to M6) at the frequency to be alarmed.</p> <p>Press the Limit Line soft key.</p> <p>Use the numeric keys to input value.</p> |

| | |
|---|---|
| [dBm] or [ENTER] | Press the unit soft key or the ENTER hard key. |
| [Volume] Enter a value [Enter] or [ENTER] | Press the Volume soft key to adjust volume. Use the numeric keys to input value. Press the Enter soft key or the ENTER hard key. |
| [Time Cursor] <On> or <Off> | Press the Time Cursor soft key to set the indicator on the display screen. This key becomes activated when the Spectrogram is selected. Toggle this key between On and Off . |

MEASURE SETUP



- n **LOAD FILE:** Retrieves a measurement file to be replayed. After connecting a USB memory device, toggle this key between **On** and **Off**.
- n **REPLAY CONTROL:** Sets replay parameters.
 - Y **REPLAY:** Starts, pauses, or continues replaying. Toggle this key between **Play** and **Pause**.
 - Y **REPLAY SPEED:** Sets replaying speed option among **x1**, **x2**, **x3**, and **x4**.
 - Y **REPLAY DIRECTION:** Sets replaying direction to forward or reverse. Toggle this key between **FWD** and **REV**.
 - Y **STOP:** Stops replaying.
 - Y **JUMP TO FAIL INDEX:** Moves replaying right to a certain failure index. Use the numeric keys to input value and then press the **Enter** soft key or the **ENTER** hard key to complete the input.
- n **DISPLAY MODE:** Sets display mode among Spectrum, RSSI, and Spectrogram.
- n **ALARM:** Sets alarm parameters. This key becomes activated when the RSSI is selected,
 - Y **ALARM:** Turns the alarm sound on or off by toggling this soft key between **On** and **Off**.
 - Y **ALARM AT:** Selects the marker(s) up to 6 different frequencies.
 - Y **LIMIT LINE:** Sets the threshold limit for the alarm sound. Use the rotary knob and the arrow keys or the numeric keys and then the unit soft key or the **ENTER** hard key.
 - Y **VOLUME:** Adjusts volume of alarm sound.
- n **TIME CURSOR:** Enables or disables the time cursor indicator. This key becomes activated when the Spectrogram is selected. Toggle this key between **On** and **Off**.

NOTE: The USB device should not be removed during any of recording or replaying. Taking the device out may freeze the USB port and system restart is needed to get a USB device recognized again.

Setting Limit



This hot key is used to set the threshold value for the display on the display screen. It turns on or off the display line, multi-segment line, or channel power limit of the measurement. The user input window must be inactive first to get the Limit hot key function other than the number input.

| Step | Description |
|--|---|
| <p>1. Set the limit</p> <p>LIMIT</p> <p>[Display Line] <On> or <Off> Enter a value [dBm] or ENTER</p> <p>[Multi Segment Line]</p> <p>[Auto Set]</p> <p>Or</p> <p>[Multi Segment Line]</p> <p>[Limit] <Upper> or <Lower></p> <p>[Limit] <On> or <Off></p> <p>[# of Line] Enter a value [Enter] or [ENTER]</p> <p>[Edit Limit]</p> <p>[Line] <On> or <Off></p> <p>[Frequency/Distance] Enter a value</p> | <p>Press the LIMIT hot key.</p> <p>Press the Display Line soft key to toggle between On and Off and select one.</p> <p>Use the numeric keys to input limit value.</p> <p>Press the unit soft key or the ENTER hard key.</p> <p>Press the Multi Segment Line soft key, which becomes activated in the Spectrum mode.</p> <p>Press the Auto Set soft key to set the segment line limit automatically.</p> <p>Press the Multi Segment Line soft key, which becomes activated in the Spectrum mode.</p> <p>Press the Limit soft key to set the pass/fail criteria upper or lower segment limit. Toggle this key between Upper and Lower.</p> <p>Press the Limit soft key to enable or disable the upper or lower segment line on the display screen.</p> <p>Press the # of Line soft key to set segment line numbers to use.</p> <p>Use the numeric keys to input value between 1 and 25.</p> <p>Press the Enter soft key or the ENTER hard key.</p> <p>Press the Edit Limit soft key to edit segment line(s) properties.</p> <p>Press the Line soft key to draw a line or not. Toggle this key between On and Off.</p> <p>Press the Frequency/Distance soft key.</p> <p>Use the numeric keys to input value.</p> |

| | |
|-------------------------------------|--|
| [GHz], [MHz], [kHz], or [Hz] | Press one of the unit soft keys to complete the input. |
| [Amplitude] | Press the Amplitude soft key. |
| Enter a value | Use the numeric keys to input value. |
| [dBm] or [ENTER] | Press the unit soft key or the ENTER hard key. |
| [Add Point] | Press the Add Point soft key to add a point on the right-hand side of the active point. |
| [Delete Point] | Press the Delete Point soft key to delete the active point. |
| [Move Point Left] | Press the Move Point Left soft key to select a point next to the left as an active point. |
| [Move Point Right] | Press the Move Point Right soft key to select a point next to the right as an active point. |
| [Move Limit] | Press the Move Limit soft key. |
| [Limit Up/Down] | Press the Limit Up/Down soft key to move the multi-segment line upward or downward. |
| Enter a value | Use the numeric keys to input value. |
| [dB] or [ENTER] | Press the dB unit soft key or the ENTER hard key. |
| [Limit Left/Right] | Press the Limit Left/Right soft key to move the multi-segment line to the left or to the right. |
| Enter a value | Use the numeric keys to input value. |
| [GHz], [MHz], [kHz], or [Hz] | Press one of the unit soft keys. |
| [Save/Recall] | Press the Save/Recall soft key to save the current setting as a file or to retrieve an existing setting. |
| [Channel Limit] | Press the Channel Limit soft key that becomes activated in the Spectrum mode to set channel limit for a selected channel. |
| [Channel] | Press the Channel soft key. |
| Enter a value | Use the numeric keys to input value between 1 and 10. |
| [Enter] or ENTER | Press the Enter soft key or the ENTER hard key. |
| [Start Frequency] | Press the Start Frequency or Center Frequency soft key depending on prior frequency setting. |
| Enter a value | Use the numeric keys to input value. |
| [GHz], [MHz], [kHz], or [Hz] | Press one of the unit soft keys to complete the input. |
| [Stop Frequency] | Press the Stop Frequency or Span Frequency soft key depending on prior frequency setting. |
| Enter a value | Use the numeric keys to input value. |
| [GHz], [MHz], [kHz], or [Hz] | Press one of the unit soft keys to complete the input. |
| [High Limit] | Press the High Limit soft key. |

| | |
|---|---|
| <p>Enter a value [dBm] or ENTER</p> | <p>Use the numeric keys to input value. Press the unit soft key or the ENTER hard key.</p> |
| <p>[Low Limit] Enter a value [dBm] or ENTER</p> | <p>Press the Low Limit soft key. Use the numeric keys to input value. Press the unit soft key or the ENTER hard key.</p> |
| <p>[Limit] <On> or <Off></p> | <p>Press the Limit soft key and toggle this key between On and Off to enable or disable channel power limit on the display screen.</p> |

- n **DISPLAY LINE:** Enables or disables the display line on the screen that activates an adjustable horizontal line that is used as a visual reference line. Toggle the **Display Line** soft key to select it to **On** or **Off**. Use the numeric keys to set the line value.
- n **MULTI SEGMENT LINE:** Sets multi-segment line(s). This key becomes activated only in the Spectrum mode.
 - Y **AUTO SET:** Sets the segment line limit automatically.
 - Y **LIMIT:** Sets the pass/fail criteria upper or lower segment limit. Toggle this key between **Upper** and **Lower**.
 - Y **LIMIT:** Enables or disables the upper or lower segment line on the display screen. Toggle this key between **On** and **Off**.
 - Y **# OF LINE:** Sets segment line numbers to be used. Use the numeric keys to input value between 1 and 25 and then press the **Enter** soft key or the **ENTER** hard key.
 - Y **EDIT LIMIT:** Edits segment line(s) properties.
 - **LINE:** Shows or hides a segment line. Toggle this key between **On** and **Off**.
 - **FREQUENCY/DISTANCE:** Sets the frequency of the segment line. Use the numeric keys to input value and then press one of the unit soft keys to complete the input.
 - **AMPLITUDE:** Sets the amplitude of the segment line. Use the numeric keys to input value and then press the unit soft key or the **ENTER** hard key.
 - **ADD POINT:** Adds a point on the right-hand side of the active point.
 - **DELETE POINT:** Deletes the active point.
 - **MOVE POINT LEFT:** Selects a point next to the left as an active point.
 - **MOVE POINT RIGHT:** Selects a point next to the right as an active point.
 - Y **MOVE LIMIT:** Moves the segment line limit.
 - **LIMIT UP/DOWN:** Moves the multi-segment line upward or downward. Use the numeric

keys to input value and then press the **dB** unit soft key or the **ENTER** hard key.

- **LIMIT LEFT/RIGHT:** Moves the multi-segment line to the left or to the right. Use the numeric keys to input value and then press one of the unit soft keys.
- Y **SAVE/RECALL:** Saves the current setting as a file or retrieves an existing setting.
- n **CHANNEL LIMIT:** Sets channel limit. This key becomes activated only in the Spectrum mode.
- Y **CHANNEL:** Selects a channel index number to be set or displayed. Use the numeric keys to input value and then press the **Enter** soft key or the **ENTER** hard key.
- Y **START FREQUENCY:** Sets the start frequency for a selected channel index. Use the numeric keys to input value and then press one of the unit soft keys. Depending on prior frequency setting, this key is interchanged with center frequency.
- Y **STOP FREQUENCY:** Sets the span frequency for a selected channel index. Use the numeric keys to input value and then press one of the unit soft keys. Depending on prior frequency setting, this key is interchanged with span frequency.
- Y **HIGH LIMIT:** Sets the upper threshold of pass/fail indicator. Use the numeric keys to input value and then press the unit soft key or the **ENTER** hard key.
- Y **LOW LIMIT:** Sets the lower threshold of pass/fail indicator. Use the numeric keys to input value and then press the unit soft key or the **ENTER** hard key.
- Y **LIMIT:** Enables or disables channel power limit on the display screen. Toggle this key between **On** and **Off**.

ANALYSIS

Using Marker

MARKER



Marker is used to get the information about a specific trace. Six markers can be set on the display and each marker can be used independently. The X and Y coordinates of the trace are displayed when the marker is placed on any position of the trace. The position displaying the marker's X and Y coordinates may be slightly different for each measurement mode and refer to the description of each measurement. There are three different marker types available: Normal, Delta, and Delta pair. Marker position can be set manually by entering numeric values (frequency) when one of the marker types is selected.

- n **SELECT MARKER:** Selects an active marker whose position can be changed with the rotary knob or the arrow keys. The assigned number of the active marker is displayed in the **Select Marker** menu box and the active marker number is also displayed right next to the active marker on the trace when the **Marker View** is set to **On**.
- n **MARKER VIEW:** Displays the selected marker on the screen or hides it. For the Spectrogram mode, there appears a vertical line on the chart as well if the marker view is on. When the **Marker View** is turned off and then on again in the same measurement mode, markers appear at the previous positions. If a measurement mode is changed, markers are not restored to their previous positions.
- n **NORMAL:** This Normal marker type provides the reading of a marker position on the trace along with the marker number between 1 and 6.
- n **DELTA:** This Delta marker type is associated with a Normal marker. A Normal marker must be set before a Delta marker is set. When the Delta marker is set, the position set by the Delta marker becomes the reference position of the Normal marker and the marker's X and Y values displays the difference compared with the Delta marker.
- n **DELTA PAIR:** This Delta Pair marker type is associated with a Normal marker. A Normal marker must be set before a Delta Pair marker is set. When the Delta Pair marker is set, the position set by the Delta Pair marker becomes the reference position of the Normal marker and the marker's X and Y values displays the difference compared with the Delta Pair marker. The reference position will be varied in accordance with trace change.
- n **MARKER ALL OFF:** Turns all the markers the screen off. When the Marker View is selected for those markers, the instrument displays those markers back at the previous position. If a measurement mode is changed, current settings are not restored.
- n **MARKER Δ :** Sets the X coordinate of the active marker as selected.
 - Y **MARKER Δ CENTER:** Sets the frequency of the active marker to the center frequency of spectrum analyzer.
 - Y **MARKER Δ START:** Sets the frequency of the active marker to the start frequency of spectrum analyzer.
 - Y **MARKER Δ STOP:** Sets the frequency of the active marker to the stop frequency of spectrum analyzer.

Using Peak Search

PEAK SEARCH



Each time the Peak Search soft key is pressed, the active marker is positioned at the highest peak of the trace.

- n **PEAK SEARCH:** Moves the active marker to the highest peak of the trace.
- n **NEXT PEAK:** Moves the active marker to the second highest peak of the trace.
- n **NEXT PEAK RIGHT:** Moves the active marker to the highest peak to the right of its current position.
- n **NEXT PEAK LEFT:** Moves the active marker to the highest peak to the left of its current position.
- n **MIN SEARCH:** Moves the active marker to the lowest peak of the trace.
- n **ALWAYS PEAK:** When the **Always Peak** is set to On, the instrument moves the active marker automatically to the highest peak of the trace every time the trace is refreshed.

Channel Scanner

This Channel Scanner function is optional that the JD740 series offers as the Option 012. It includes measurements of multiple transmission signals up to 20 channels in GSM, CDMA and/or WCDMA networks.

In this Chapter

| | |
|-----------------------------------|----|
| Using Channel Scanner..... | 2 |
| Display Overview..... | 2 |
| Connecting a Cable..... | 4 |
| Direct Connection..... | 4 |
| Indirect Connection..... | 4 |
| Over The Air (OTA)..... | 5 |
| Channel Scanner Measurements..... | 6 |
| Setting Mode..... | 6 |
| Setting Amplitude..... | 6 |
| Setting Averaging..... | 7 |
| Setting Sweep Mode..... | 8 |
| Channel Scanner..... | 8 |
| Measurement Procedure..... | 8 |
| Setting Limit..... | 9 |
| Measurement Example..... | 11 |
| Frequency Scanner..... | 11 |
| Measurement Procedure..... | 11 |
| Setting Limit..... | 12 |
| Measurement Example..... | 13 |
| Custom Scanner..... | 14 |
| Measurement Procedure..... | 14 |
| Setting Limit..... | 15 |
| Measurement Example..... | 16 |
| Analysis..... | 17 |
| Using Marker..... | 17 |
| Using Peak Search..... | 18 |

(Rev. 6.0)

USING CHANNEL SCANNER

A Channel Scanner is a radio receiver that can automatically tune or scan two or more discrete frequencies and multi-channels, indicating when it finds a signal on one of them and then continuing scanning when that frequency goes silent.

The Channel Scanner can measure up to 20 channels. Using existing format-based or custom parameters, the user will be able to easily verify improper multi-channel power levels.

- n Channel Scanner
- n Frequency Scanner
- n Custom Scanner (Channel or Frequency)

DISPLAY OVERVIEW



Measurement Mode Information: Channel Scanner

Spectrum Input Level Setting Information: This window shows the most common settings or parameters of each measurement.

- Frequency and Channel Setting
- Amplitude Setting (Preamp, Attenuation, External Offset)
- Reference Setting (Frequency, Trigger)

Measurement Setting Information

- Detect Mode Information (Range, Custom)
- Detector Type Setting Information
- Spectrum Setting Information (RBW, VBW)
[A]: Auto mode, [M]: Manual mode
- Integration Bandwidth Information: Displays the bandwidth to be scanned
- Channel Step: Displays the channel step size
- Average Number Information set through BW/AVG hard key. It shows the number of traces to be averaged.

Scanner (Channel/Frequency) Table Information: Displays channel or frequency up to 20

Screen Menu Title

Screen Menu and Sub-menu

Bar graph showing tracked Channels or Frequencies

User Input Window: Activates when user input menu or key is selected. Pressing ESC hard key will cancel or deactivate user input window. Inactivate user input window before using hot keys.

NOTE: It is very important to inactivate the user input window when you intend to use the hot key menu on the numeric keys.

System Information

- Date and Time
- Positioning Information (Longitude and Latitude). It is available only when a GPS antenna is connected. Frequency reference is automatically set to GPS in the System menu when a GPS antenna is connected.
- Frequency Reference Indicator: INT for internal and EXT for external. The EXT icon is green when an external reference is locked or red when the external reference is not locked. When a GPS antenna is connected, this space will be blank.
- GPS Indicator: Color of the GPS icon changes among green, yellow and gray depending on locking status.
- USB Indicator
- DC Input Power Indicator
- Battery Indicator

CONNECTING A CABLE

Direct Connection

Connect the **Spectrum Analyzer RF In 50 Ω** port of the JD740 series and the PA output port of BTS.

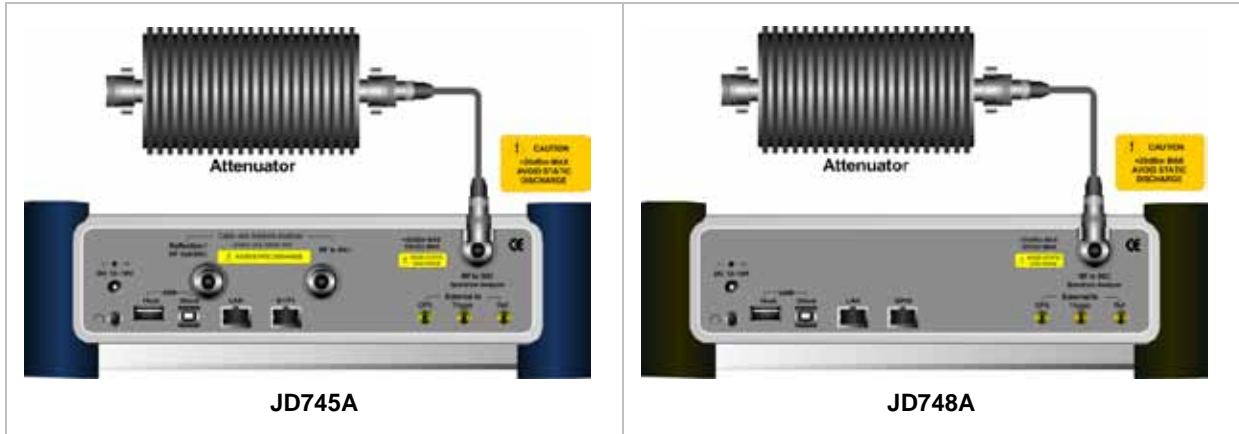

Indirect Connection

Connect the **Spectrum Analyzer RF In 50 Ω** port of the JD740 series and the monitor port of BTS.

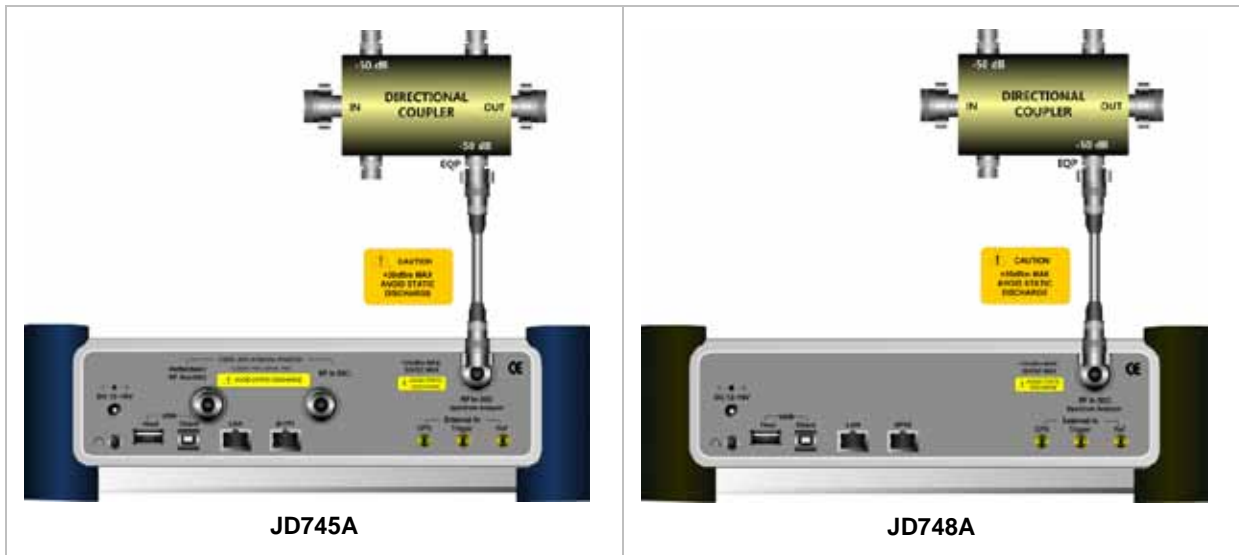

The maximum power for the **Spectrum Analyzer RF In 50 Ω** port is +20 dBm (0.1 Watt). If the input signal level to be measured is greater than +20 dBm, use a **High Power Attenuator** to prevent damage when you directly connect the signal to the instrument. Or connect a signal from the coupling port of a directional coupler.

Over The Air (OTA)

Connect an Omni/directional RF antenna to the **Spectrum Analyzer RF In 50 Ω** port of the JD740 series and then a GPS antenna to the **GPS** port of the JD740 series.

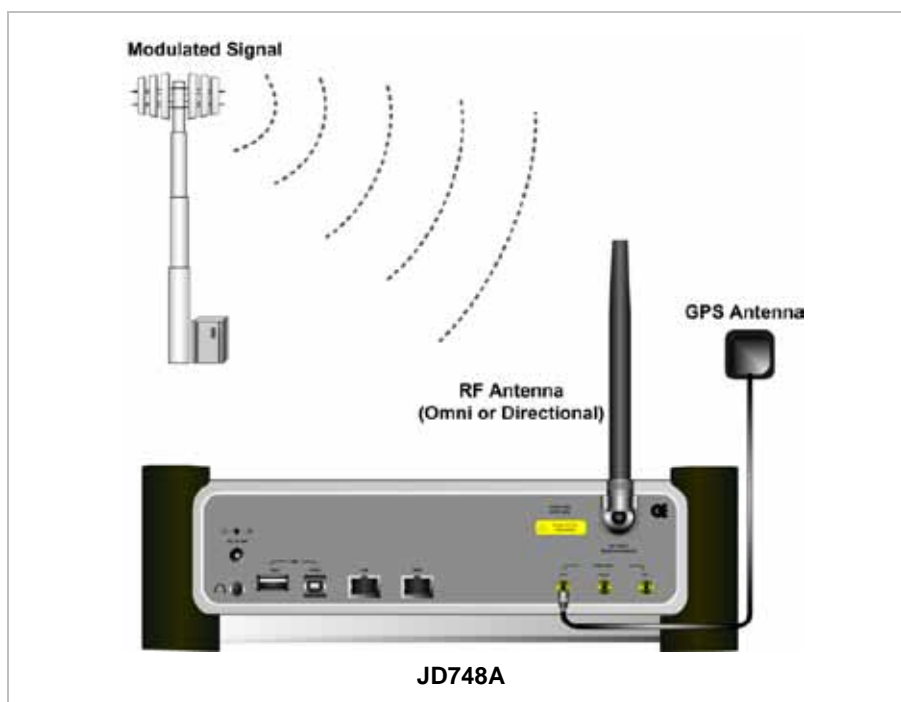
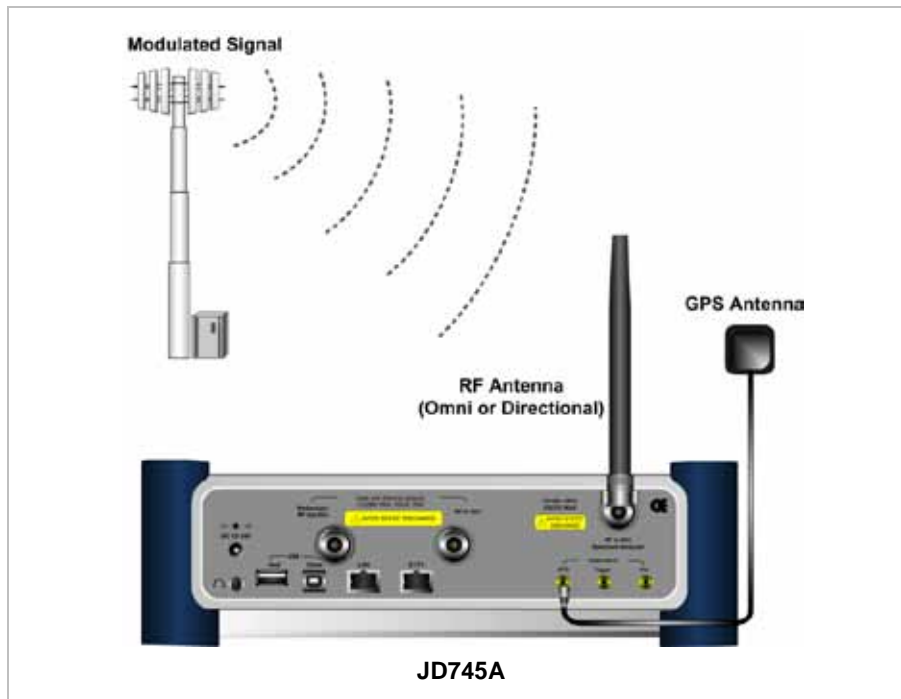

If the input signal level to be measured is less than 0 dBm, set 0 dB attenuation or turn on the preamp to have better dynamic range for the OTA testing.

CHANNEL SCANNER MEASUREMENTS

The Channel Scanner function of the JD740 series provides a simple view of the power level of each signal type. Test results can be saved as a *.csv file format so that you can work on it in any spreadsheet software.

Setting Mode

| Step | Description |
|---|---|
| 1. Connect the cable or the antenna | Connect a cable directly or indirectly or connect antennas as shown in the Connecting a Cable on page 4 of this chapter. |
| 2. Select the mode MODE [Channel Scanner] [Channel Scanner] , [Frequency Scanner] , or [Custom Scanner] | Press the MODE hard key. Press the Channel Scanner soft key. Press one of the measurement mode soft keys to select. (Channel Scanner mode is set by default.) |

Setting Amplitude

| Step | Description |
|---|---|
| 1. Set the reference/attenuation level AMP/SCALE [Auto Scale] or [Reference Level] Enter a reference level value [dBm] or ENTER [Attenuation] <Manual> Enter an attenuation value | Press the AMP/SCALE hard key. Press the Auto Scale soft key to automatically set optimum levels of reference and attenuation. Press the Reference Level soft key to set manually. Use the numeric keys or the rotary knob that changes in a 10 dB step. Press the dBm soft key or the ENTER hard key. Press the Attenuation soft key. The Auto mode is set by default. This key toggles between the Auto and Manual . Press the Attenuation soft key to highlight the Manual mode and change the attenuation value to optimize S/N. Use the numeric keys or the rotary knob that changes in a 5 dB step. The attenuation setting range is 0 to 50 dB. |

AMP/SCALE



- n **AUTO SCALE:** The instrument can automatically set the scale to the minimum and maximum values on the Y-axis of the graph for optimum display of the traces measured. Each time the **Auto Scale** is selected, the top and bottom scales are set to the minimum and maximum values with margin on the Y-axis of the display screen.
- n **REFERENCE LEVEL:** Sets the maximum Y-axis range.
- n **ATTENUATION**
 - Y **AUTO:** Input attenuator's value is automatically set depending on the reference level. This is the default operation mode, so it is recommended to use this mode unless a special measurement condition is needed.
 - Y **MANUAL:** Sets the attenuator's value for the **Spectrum Analyzer RF In 50 Ω** port.
- n **PREAMP:** Turns on or off the internal pre-amplifier. Preamp results in a correction being applied to compensate for the gain of the preamp so that amplitude readings show the value at the input connector. This soft key toggles between the **On** and **Off**. When it is set to On, the allowable attenuation input range is from 0 dB to 10 dB in a multiple of 5. If the attenuation value is manually set greater than 10 dB, the instrument will automatically turn off the pre-amplifier to display low level signal properly on the screen.
- n **UNITS:** Sets the scale unit on the display among **dBm**, **dBV**, **dBmV**, **dBuV**, **V**, and **W**.
- n **EXTERNAL OFFSET:** Sets an external offset value. An offset consists of a cable loss and a user offset and the measurement result shows the value reflecting both offset values. When the external offset value is set at 40 dB in the Spectrum mode, the measurement result compensates 40 dB at both the Spectrum Analyzer and Signal Analyzer modes.

Setting Averaging

| Step | Description |
|---|--|
| 1. Set the averaging BW/AVG [Average] | Press the BW/AVG hard key. Press the Average soft key. |
| 2. Enter number of averaging to set | Use the numeric keys and input a number between 1 and 100. When the averaging reaches to the number set here, a new measurement value replaces the earliest measurement value in sequence. |
| 3. [Enter] or ENTER | Press the Enter soft key or the ENTER hard key. |

BW/AVG 

- n **AVERAGE:** Sets the number of measurements to be averaged for the trace presentation. A maximum of 100 times of averaging can be set.

Setting Sweep Mode

SWEEP 

This hot key is used to set the sweep parameters. The user input window must be inactive first to get the Sweep hot key function other than the number input.

| Step | Description |
|--|---|
| 1. Set the sweep mode SWEEP [Sweep Mode] | Press the SWEEP hot key. Press the Sweep Mode soft key. Toggle between Continue and Single . |

- n **SWEEP MODE:** Sets the sweep method. Toggle between **Continue** and **Single**.

CHANNEL SCANNER

Measurement Procedure

| Step | Description |
|---|--|
| 1. Select the measurement mode MEASURE [Channel Scanner] | Press the MEASURE hot key. Press the Channel Scanner soft key. |
| 2. Set the channel to be scanned FREQ/DIST [Channel Standard] Select a channel [Select] or ENTER | Press the FREQ/DIST hard key. Press the Channel Standard soft key to select the channel standard. Press the arrow keys, rotate the knob, or press the Page Up and the Page Down soft keys to highlight a frequency band to select. Press the Select soft key or the ENTER hard key. |

| | |
|---|---|
| <p>[Link] <FWD> or <REV></p> | <p>Press the Link soft key to set the link direction. Toggle this key between FWD and REV.</p> |
| <p>[Start Channel] Enter a value [Enter] or ENTER</p> | <p>Press the Start Channel soft key. Turn the rotary knob to change the value. Or use the numeric keys to input value manually and press the Enter soft key or ENTER hard key to complete the input.</p> |
| <p>[Channel Step] Enter a value [Enter] or ENTER</p> | <p>Press the Channel Step soft key. Use the numeric keys. Press the Enter soft key or ENTER hard key.</p> |
| <p>[# of Channels] Enter a value between 1 and 20 [Enter] or ENTER</p> | <p>Press the # of Channels soft key. Use the numeric keys. Press the Enter soft key or ENTER hard key.</p> |

FREQ/DIST



- n **START CHANNEL:** Changes the starting channel in the channel scanner. The first channel in the channel table on the screen changes accordingly.
- n **CHANNEL STEP:** Sets the channel increment step size. Channels listed in the channel table on the screen increase in this step.
- n **# OF CHANNELS:** Sets the number of channels to be scanned and listed up to 20 channels in the channel table on the screen. Values from 1 to 20 can be entered with the numeric keys and the input is completed by pressing the **Enter** soft key or **ENTER** hard key.
- n **LINK:** Sets the direction of scanning: FWD for forward or REV for reverse.
- n **CHANNEL STANDARD:** When the channel standard is selected from the list, the start frequency information on the display screen will be mapped accordingly to the selected channel standard. The channel standards available in the instrument are listed in the Appendix C – Band, Frequency & Channel Standard.

Setting Limit

LIMIT



This hot key is used to set the threshold value for the display on the display screen. It turns on or off the display line of the measurement and Pass/Fail result on the display screen. An individual channel limit can be configured independently with this key. The user input window must be inactive first to get

the Limit hot key function other than the number input.

| Step | Description |
|---|--|
| <p>1. Set the limit</p> <p>LIMIT</p> <p>[Display Line] <On> or <Off> Enter a value [dBm] or ENTER</p> <p>[Channel Limit]</p> <p>[Channel Index] Enter a value [Enter] or ENTER</p> <p>[High Limit] Enter a value [dBm] or ENTER</p> <p>[Low Limit] Enter a value [dBm] or ENTER</p> <p>[Limit] <On> or <Off></p> | <p>Press the LIMIT hot key.</p> <p>Press the Display Line soft key to toggle between On and Off and select one.</p> <p>Use the numeric keys to input limit value.</p> <p>Press the unit soft key or the ENTER hard key.</p> <p>Press the Channel Limit soft key to set channel limit for a selected channel.</p> <p>Press the Channel Index soft key to select a channel index number to be set.</p> <p>Use the numeric keys to input value between 1 and 10.</p> <p>Press the Enter soft key or the ENTER hard key.</p> <p>Press the High Limit soft key.</p> <p>Use the numeric keys to input value.</p> <p>Press the unit soft key or the ENTER hard key.</p> <p>Press the Low Limit soft key.</p> <p>Use the numeric keys to input value.</p> <p>Press the unit soft key or the ENTER hard key.</p> <p>Press the Limit soft key and toggle this key between On and Off to enable or disable channel power limit on the display screen.</p> |

- n **DISPLAY LINE:** Enables or disables the display line as well as Pass/Fail result on the screen that activates an adjustable horizontal line that is used as a visual reference line. Toggle the **Display Line** soft key to select it to **On** or **Off**. Use the numeric keys to set the line value.
- n **CHANNEL LIMIT:** Sets channel limit.
- Y **CHANNEL INDEX:** Selects a channel index number to be set or displayed. Use the numeric keys to input value and then press the **Enter** soft key or the **ENTER** hard key.
- Y **HIGH LIMIT:** Sets the upper threshold of pass/fail indicator. Use the numeric keys to input value and then press the unit soft key or the **ENTER** hard key.
- Y **LOW LIMIT:** Sets the lower threshold of pass/fail indicator. Use the numeric keys to input value and then press the unit soft key or the **ENTER** hard key.
- Y **LIMIT:** Enables or disables channel power limit on the display screen. Toggle this key between **On** and **Off**.

Measurement Example



FREQUENCY SCANNER

Measurement Procedure

| Step | Description |
|--|--|
| 1. Select the measurement mode MEASURE [Frequency Scanner] | Press the MEASURE hot key. Press the Frequency Scanner soft key. |
| 2. Set the frequency to be scanned FREQ/DIST [Start Frequency] Enter a value [GHz], [MHz], [kHz], or [Hz] [Frequency Step] Enter a value | Press the FREQ/DIST hard key. Press the Start Frequency soft key. Use the numeric keys to input value. Press one unit soft key to choose. Press the Frequency Step soft key. Use the numeric keys. |

| | |
|---|--|
| <p>[GHz], [MHz], [kHz], or [Hz]</p> <p> [# of Frequencies] Enter a value between 1 and 20 [Enter] or ENTER</p> | <p>Press one unit soft key to choose.</p> <p>Press the # of Frequencies soft key. Use the numeric keys. Press the Enter soft key or ENTER hard key.</p> |
| <p>3. Set the integration bandwidth FREQ/DIST [Integration Bandwidth] Enter a value [GHz], [MHz], [kHz], or [Hz]</p> | <p>Press the FREQ/DIST hard key. Press the Integration Bandwidth soft key. Use the numeric keys to input value. Press one unit soft key to choose.</p> |

FREQ/DIST



- n **START FREQUENCY:** Changes the starting center frequency in the channel scanner. The first CF in the frequency table on the screen changes accordingly. Values can be entered with the numeric keys and the input is completed by pressing the unit soft key.
- n **FREQUENCY STEP:** Sets the frequency increment step size. CFs listed in the frequency table on the screen increase in this step selected. Values can be entered with the numeric keys and the input is completed by pressing the unit soft key.
- n **INTEGRATION BANDWIDTH:** Sets the integration bandwidth to be measured. Values can be entered with the numeric keys and the input is completed by pressing the unit soft key.
- n **# OF FREQUENCIES:** Sets the number of frequencies to be scanned and listed up to 20 frequencies in the frequency table on the screen. Values from 1 to 20 can be entered with the numeric keys and the input is completed by pressing the **Enter** soft key or **ENTER** hard key.

Setting Limit

LIMIT



This hot key is used to set the threshold value for the display on the display screen. It turns on or off the display line of the measurement and Pass/Fail result on the display screen. An individual frequency limit can be configured independently with this key. The user input window must be inactive first to get the Limit hot key function other than the number input.

| Step | Description |
|--|--|
| <p>1. Set the limit LIMIT</p> | <p>Press the LIMIT hot key.</p> |

| | |
|--|--|
| <p>[Display Line] <On> or <Off> Enter a value [dBm] or ENTER</p> | <p>Press the Display Line soft key to toggle between On and Off and select one. Use the numeric keys to input limit value. Press the unit soft key or the ENTER hard key.</p> |
| <p>[Channel Limit] [Channel Index] Enter a value [Enter] or ENTER</p> | <p>Press the Channel Limit soft key to set channel limit for a selected channel. Press the Channel Index soft key to select a channel index number to be set. Use the numeric keys to input value between 1 and 10. Press the Enter soft key or the ENTER hard key.</p> |
| <p>[High Limit] Enter a value [dBm] or ENTER</p> | <p>Press the High Limit soft key. Use the numeric keys to input value. Press the unit soft key or the ENTER hard key.</p> |
| <p>[Low Limit] Enter a value [dBm] or ENTER</p> | <p>Press the Low Limit soft key. Use the numeric keys to input value. Press the unit soft key or the ENTER hard key.</p> |
| <p>[Limit] <On> or <Off></p> | <p>Press the Limit soft key and toggle this key between On and Off to enable or disable channel power limit on the display screen.</p> |

- n **DISPLAY LINE:** Enables or disables the display line as well as Pass/Fail result on the screen that activates an adjustable horizontal line that is used as a visual reference line. Toggle the **Display Line** soft key to select it to **On** or **Off**. Use the numeric keys to set the line value.
- n **CHANNEL LIMIT:** Sets channel limit.
- Y **CHANNEL INDEX:** Selects a channel index number to be set or displayed. Use the numeric keys to input value and then press the **Enter** soft key or the **ENTER** hard key.
- Y **HIGH LIMIT:** Sets the upper threshold of pass/fail indicator. Use the numeric keys to input value and then press the unit soft key or the **ENTER** hard key.
- Y **LOW LIMIT:** Sets the lower threshold of pass/fail indicator. Use the numeric keys to input value and then press the unit soft key or the **ENTER** hard key.
- Y **LIMIT:** Enables or disables channel power limit on the display screen. Toggle this key between **On** and **Off**.

Measurement Example

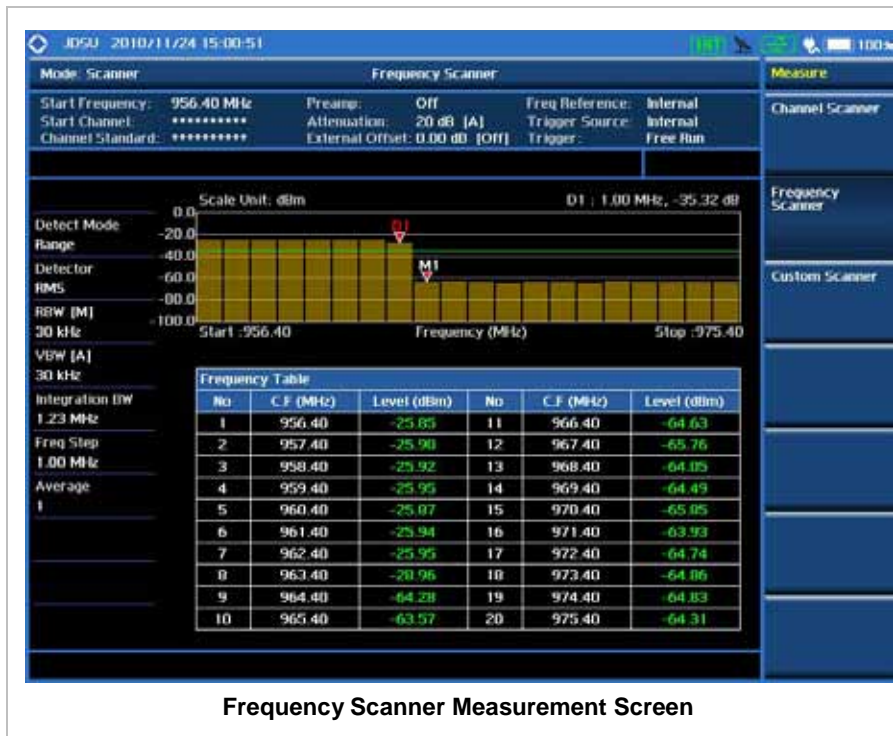

Frequency Scanner Measurement Screen

CUSTOM SCANNER

The user can easily verify improper multi-channel power level using the custom parameters.

Measurement Procedure

| Step | Description |
|--|--|
| 1. Select the measurement mode MEASURE [Custom Scanner] | Press the MEASURE hot key. Press the Custom Scanner soft key. |
| 2. Set the channel to be scanned MEASURE SETUP [Edit List] [Add] | Press the MEASURE SETUP hot key. Press the Edit List soft key to add, delete, or edit the list of channels to be scanned and a list of channels will pop up. Press the Add soft key to add a channel to the list. To change a channel standard, use the rotary knob to highlight the channel standard and then press the center of the rotary knob or the ENTER hard key. In the band list |

| | |
|----------------------------------|---|
| <p>or</p> <p>[Delete]</p> | <p>pop-up window, use the rotary knob or the arrow keys to highlight a channel band and then press the center of the rotary knob or the ENTER hard key. To change the channel number or frequency, use the rotary knob to highlight the channel number or the frequency and then press the center of the rotary knob or the ENTER hard key. Use numeric keys to enter a value and then press the ENTER hard key to complete the entry.</p> <p>In the Edit List window, use the rotary knob or the arrow keys to highlight a channel to delete and then press the Delete hard key.</p> |
|----------------------------------|---|

MEASURE SETUP

- n **EDIT LIST:** Adds new channel(s) from the standards to be measured and deletes or edits existing channel standard(s) on the pop-up list window. Up to 20 channels can be added for measurement.

Setting Limit

LIMIT

This hot key is used to set the threshold value for the display on the display screen. It turns on or off the display line of the measurement and Pass/Fail result on the display screen. An individual channel (frequency) limit can be configured independently with this key. The user input window must be inactive first to get the Limit hot key function other than the number input.

| Step | Description |
|--|--|
| <p>1. Set the limit</p> <p>LIMIT</p> <p>[Display Line]</p> <p><On> or <Off></p> <p>Enter a value</p> <p>[dBm] or ENTER</p> <p>[Channel Limit]</p> <p>[Channel Index]</p> | <p>Press the LIMIT hot key.</p> <p>Press the Display Line soft key to toggle between On and Off and select one.</p> <p>Use the numeric keys to input limit value.</p> <p>Press the unit soft key or the ENTER hard key.</p> <p>Press the Channel Limit soft key to set channel limit for a selected channel.</p> <p>Press the Channel Index soft key to select a channel index number to be set.</p> |

| | |
|--|---|
| <p>Enter a value [Enter] or ENTER</p> | <p>Use the numeric keys to input value between 1 and 10. Press the Enter soft key or the ENTER hard key.</p> |
| <p>[High Limit] Enter a value [dBm] or ENTER</p> | <p>Press the High Limit soft key. Use the numeric keys to input value. Press the unit soft key or the ENTER hard key.</p> |
| <p>[Low Limit] Enter a value [dBm] or ENTER</p> | <p>Press the Low Limit soft key. Use the numeric keys to input value. Press the unit soft key or the ENTER hard key.</p> |
| <p>[Limit] <On> or <Off></p> | <p>Press the Limit soft key and toggle this key between On and Off to enable or disable channel power limit on the display screen.</p> |

- n **DISPLAY LINE:** Enables or disables the display line as well as Pass/Fail result on the screen that activates an adjustable horizontal line that is used as a visual reference line. Toggle the **Display Line** soft key to select it to **On** or **Off**. Use the numeric keys to set the line value.
- n **CHANNEL LIMIT:** Sets channel limit.
- Y **CHANNEL INDEX:** Selects a channel index number to be set or displayed. Use the numeric keys to input value and then press the **Enter** soft key or the **ENTER** hard key.
- Y **HIGH LIMIT:** Sets the upper threshold of pass/fail indicator. Use the numeric keys to input value and then press the unit soft key or the **ENTER** hard key.
- Y **LOW LIMIT:** Sets the lower threshold of pass/fail indicator. Use the numeric keys to input value and then press the unit soft key or the **ENTER** hard key.
- Y **LIMIT:** Enables or disables channel power limit on the display screen. Toggle this key between **On** and **Off**.

Measurement Example

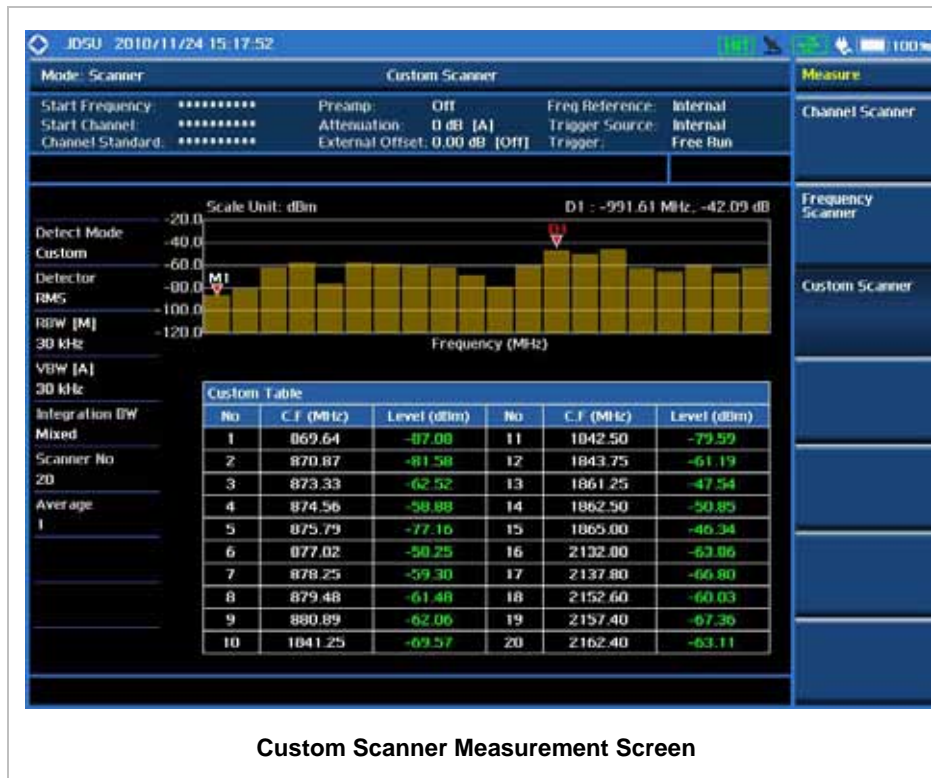

ANALYSIS

Using Marker

MARKER



Marker is used to get the information about a specific trace. Six markers can be set on the display and each marker can be used independently. The X and Y coordinates of the trace are displayed when the marker is placed on any position of the trace. The position displaying the marker's X and Y coordinates may be slightly different for each measurement mode and refer to the description of each measurement. There are three different marker types available: Normal, Delta, and Delta pair. Marker position can be set manually by entering numeric values (frequency) when one of the marker types is selected.

- n **SELECT MARKER:** Selects an active marker whose position can be changed with the rotary knob or the arrow keys. The assigned number of the active marker is displayed in the **Select Marker** menu box and the active marker number is also displayed right next to the active marker on the trace when the **Marker View** is set to **On**.
- n **MARKER VIEW:** Displays the selected marker on the screen or hides it. When the **Marker View**

is turned off and then on again in the same measurement mode, markers appear at the previous positions. If a measurement mode is changed, markers are not restored to their previous positions.

- n **NORMAL:** This Normal marker type provides the reading of a marker position on the trace along with the marker number between 1 and 6.
- n **DELTA:** This Delta marker type is associated with a Normal marker. A Normal marker must be set before a Delta marker is set. When the Delta marker is set, the position set by the Delta marker becomes the reference position of the Normal marker and the marker's X and Y values displays the difference compared with the Delta marker.
- n **DELTA PAIR:** This Delta Pair marker type is associated with a Normal marker. A Normal marker must be set before a Delta Pair marker is set. When the Delta Pair marker is set, the position set by the Delta Pair marker becomes the reference position of the Normal marker and the marker's X and Y values displays the difference compared with the Delta Pair marker. The reference position will be varied in accordance with trace change.
- n **MARKER ALL OFF:** Turns all the markers the screen off. When the Marker View is selected for those markers, the instrument displays those markers back at the previous position. If a measurement mode is changed, current settings are not restored.

Using Peak Search

PEAK SEARCH

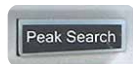

Each time the Peak Search soft key is pressed, the active marker is positioned at the highest peak of the trace.

- n **PEAK SEARCH:** Moves the active marker to the highest peak of the trace.
- n **NEXT PEAK:** Moves the active marker to the second highest peak of the trace.
- n **NEXT PEAK RIGHT:** Moves the active marker to the highest peak to the right of its current position.
- n **NEXT PEAK LEFT:** Moves the active marker to the highest peak to the left of its current position.
- n **MIN SEARCH:** Moves the active marker to the lowest peak of the trace.
- n **ALWAYS PEAK:** When the **Always Peak** is set to On, the instrument moves the active marker automatically to the highest peak of the trace every time the trace is refreshed.

CDMA Signal Analyzer

This CDMA Signal Analyzer function is optional that the JD740A series offers as the Option 020. It allows the user to analyze cdmaOne/CDMA2000 system performance. The user may alter the measurement parameters for specialized analysis. The CDMA OTA Analyzer which is the Option 040 can be added to the CDMA Signal Analyzer for Over The Air measurement.

In this Chapter

| | |
|------------------------------------|----|
| Using CDMA Signal Analyzer | 4 |
| Display Overview | 5 |
| Connecting a Cable | 7 |
| Direct Connection..... | 7 |
| Indirect Connection | 7 |
| Over The Air (OTA) | 8 |
| Spectrum Analysis Measurement..... | 9 |
| Setting Mode | 9 |
| Setting Frequency | 10 |
| Setting Amplitude | 11 |
| Setting Averaging | 12 |
| Setting Sweep Mode | 12 |
| Setting Trigger Source | 13 |
| Setting External Clock..... | 13 |
| Setting Trace and Display | 15 |
| Measurement Procedure | 15 |
| Measurement Example | 15 |
| RF Analysis Measurements..... | 16 |
| Setting Mode | 16 |
| Setting Frequency | 17 |
| Setting Amplitude | 18 |
| Setting Averaging | 19 |
| Setting Sweep Mode | 20 |
| Setting Trigger Source | 20 |
| Setting External Clock..... | 20 |
| Channel Power | 22 |
| Measurement Procedure | 22 |
| Setting Limit | 23 |
| Measurement Example | 23 |
| Occupied Bandwidth..... | 24 |
| Measurement Procedure | 24 |
| Setting Limit | 24 |
| Measurement Example | 25 |

| | |
|---------------------------------------|----|
| Spectrum Emission Mask (SEM)..... | 26 |
| Measurement Procedure | 26 |
| Setting Limit | 27 |
| Measurement Example | 27 |
| ACPR..... | 28 |
| Measurement Procedure | 28 |
| Setting Limit | 28 |
| Measurement Example | 29 |
| Multi-ACPR..... | 30 |
| Measurement Procedure | 30 |
| Setting Limit | 31 |
| Measurement Example | 32 |
| Spurious Emissions | 32 |
| Measurement Procedure | 32 |
| Setting Limit | 34 |
| Measurement Example | 35 |
| Modulation Analysis Measurements..... | 36 |
| Setting Mode | 36 |
| Setting Frequency | 36 |
| Setting Amplitude | 38 |
| Setting Sweep Mode | 39 |
| Setting Trigger Source | 39 |
| Setting External Clock..... | 39 |
| Constellation..... | 41 |
| Measurement Procedure | 41 |
| Setting Limit | 42 |
| Measurement Example | 44 |
| Code Domain Power | 44 |
| Measurement Procedure | 45 |
| Setting Limit | 46 |
| Setting Display | 47 |
| Measurement Example | 47 |
| Codogram..... | 48 |
| Measurement Procedure | 48 |
| Setting Display | 50 |
| Measurement Example | 50 |
| RCSI..... | 51 |
| Measurement Procedure | 51 |
| Setting Display | 52 |
| Measurement Example | 53 |
| CDP Table..... | 53 |
| Measurement Procedure | 53 |
| Setting Display | 54 |
| Measurement Example | 55 |
| Auto Measurement | 55 |
| Setting Mode | 56 |
| Setting Frequency | 56 |
| Setting Trigger Source | 57 |
| Setting External Clock..... | 57 |
| Setting Limit | 59 |
| Measurement Procedure | 61 |
| Setting Display | 63 |
| Power Statistics CCDF | 63 |

| | |
|----------------------------------|----|
| Setting Mode | 63 |
| Setting Frequency | 64 |
| Setting Amplitude | 65 |
| Setting Sweep Mode | 66 |
| Setting Trigger Source | 66 |
| Setting External Clock..... | 66 |
| Measurement Procedure | 68 |
| Measurement Example | 68 |
| CDMA OTA Measurements | 69 |
| Setting Mode | 70 |
| Setting Frequency | 70 |
| Setting Amplitude | 71 |
| Setting Sweep Mode | 73 |
| Setting Trigger Source | 73 |
| Setting External Clock..... | 73 |
| CDMA OTA Channel Scanner | 75 |
| Measurement Procedure | 75 |
| Setting Limit | 76 |
| Measurement Example | 77 |
| CDMA OTA PN Scanner..... | 77 |
| Measurement Procedure | 77 |
| Measurement Example | 78 |
| CDMA OTA Multipath Profile | 79 |
| Measurement Procedure | 79 |
| Measurement Example | 79 |
| CDMA OTA Code Domain Power | 80 |
| Measurement Procedure | 80 |
| Setting Limit | 82 |
| Setting Display | 85 |
| Measurement Example | 85 |
| CDMA Route Map..... | 86 |
| Measurement Procedure | 86 |
| Setting Limit | 88 |
| Measurement Example | 89 |
| Analysis | 90 |
| Using Marker..... | 90 |
| Using Peak Search | 91 |

(Rev. 6.0)

USING CDMA SIGNAL ANALYZER

This CDMA Signal Analyzer can be used to test a CDMA transmitter including cdmaOne and CDMA2000 signals to check the base station's compliance with following standards documentation.

- n 3GPP2 C.S0002 Physical Layer Standard for CDMA2000 Spread Spectrum Systems
- n 3GPP2 C.S0010 Recommended Minimum Performance Standards for CDMA2000 Spread Spectrum Base Station

This instrument automatically makes standard defined measurements using the measurement methods and limits as defined in the standards. Detailed measurement results allow the user to analyze cdmaOne and CDMA2000 system performance.

- n cdmaOne uses dual BPSK (Binary Phase-Shifting Key) for the forward link and OQPSK (Offset Quadrature Phase Shift Keying) for the reverse link.
- n CDMA2000 uses QPSK (Quadrature Phase Shift Keying) modulation for the forward link and QPSK modulation with HPSK spreading for the reverse link. Both forward and reverse links may have several channels, and individual characteristics for each channel. The chip rate depends on the mode selected.

The CDMA Signal Analyzer of the JD740A series provides the following analysis tools for CDMA system. The user may alter the measurement parameters for specialized analysis. Pass/Fail testing with standard defined or user defined upper and lower limits and the Pass/Fail indicator help the user to determine base station performance easily.

- n Spectrum Analysis
- n RF Analysis
 - Y Channel Power
 - Y Occupied Bandwidth
 - Y Spectrum Emission Mask
 - Y Adjacent Channel Power Ratio (ACPR)
 - Y Multi-ACPR
 - Y Spurious Emissions

- n Modulation Analysis
 - Y Constellation
 - Y Code Domain Power (CDP)
 - Y Codogram
 - Y Received Code Strength Indicator (RCSI)
 - Y CDP Table

- n Auto Measure

- n Power Statistics CCDF

- n Over The Air (OTA)
 - Y Channel Scanner
 - Y PN Scanner
 - Y Multipath Profile
 - Y Code Domain Power
 - Y Route Map

DISPLAY OVERVIEW

Measurement Mode Information: CDMA Analyzer

Spectrum Input Level Setting Information: This window shows the most common settings or parameters of each measurement.

- Frequency and Channel Setting
- Amplitude Setting (Preamp, Attenuation, External Offset)
- Reference Setting (Frequency, Trigger)

Measurement Setting Information

- Spectrum Analyzer Operation Mode Information
- Detector Type Setting Information
- Spectrum Setting Information (RBW, VBW)
- [A]: Auto mode, [M]: Manual mode
- Sweep Time Information: Displays current sweep time
- Average Number Information set through BW/AVG hard key. It shows the number of traces to be averaged.

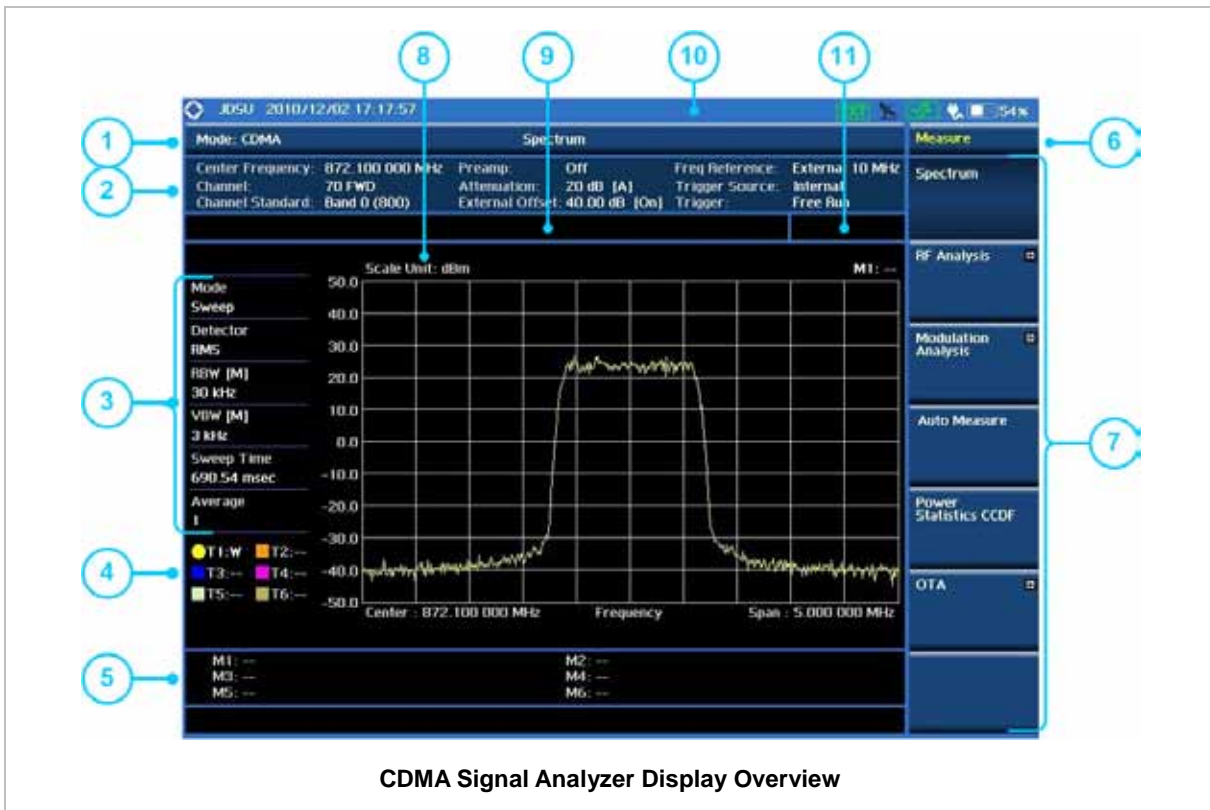

CDMA Signal Analyzer Display Overview

Trace Information

- C: Captured
- M: Max Hold
- m: Min Hold
- W: Write Current Trace (Indicates current active trace)
- L: Loaded
- F: Trace View Off

Information on Marker Table displays up to 6 markers

Screen Menu Title

Screen Menu and Sub-menu

Scale Unit Information: dBm, dBV, dBmV, dBuV, V, and W

User Input Window: Activates when user input menu or key is selected. Pressing ESC hard key will cancel or deactivate user input window. Inactivate user input window before using hot keys.

NOTE: It is very important to inactivate the user input window when you intend to use the hot key menu on the numeric keys.

System Information

- Date and Time
- Positioning Information (Longitude and Latitude). It is available only when a GPS antenna is connected. Frequency reference is automatically set to GPS in the System menu when a GPS antenna is connected.
- Frequency Reference Indicator: INT for internal and EXT for external. The EXT icon is

green when an external reference is locked or red when the external reference is not locked. When a GPS antenna is connected, this space will be blank.

- GPS Indicator: Color of the GPS icon changes among green, yellow and gray depending on locking status.
- USB Indicator
- DC Input Power Indicator
- Battery Indicator

Pass/Fail Indicator

CONNECTING A CABLE

Direct Connection

Connect the **Spectrum Analyzer RF In 50 Ω** port of the JD740A series and the PA output port of BTS.

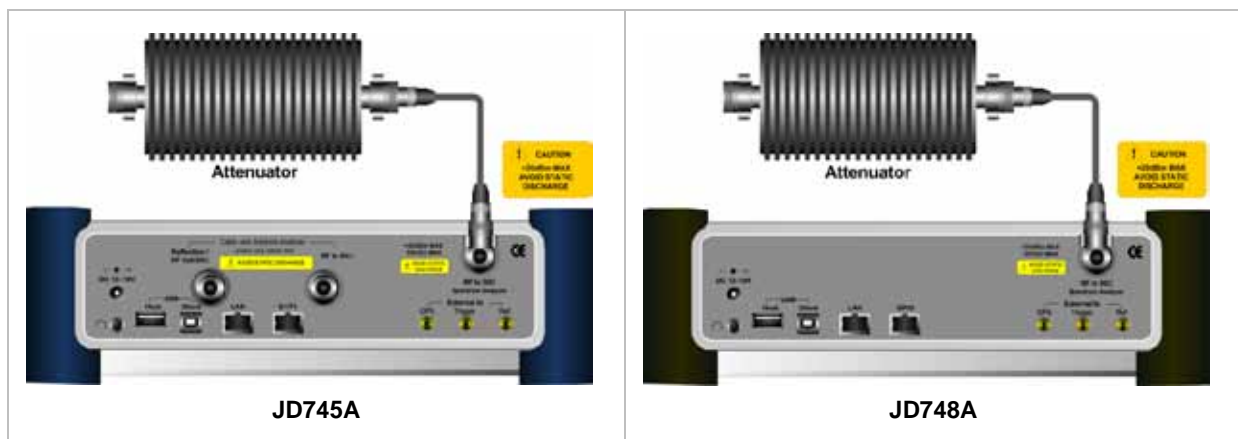

Indirect Connection

Connect the **Spectrum Analyzer RF In 50 Ω** port of the JD740A series and the monitor port of BTS.



The maximum power for the **Spectrum Analyzer RF In 50 Ω** port is +20 dBm (0.1 Watt). If the input signal level to be measured is greater than +20 dBm, use a **High Power Attenuator** to prevent damage when you directly connect the signal to the instrument. Or connect a signal from the coupling port of a directional coupler.



For accurate PN Offset and Time Offset measurements in the CDMA Signal Analyzer mode, a PP2S should be connected to the External Trigger. Without a GPS connection, measurement results could be invalid numbers.

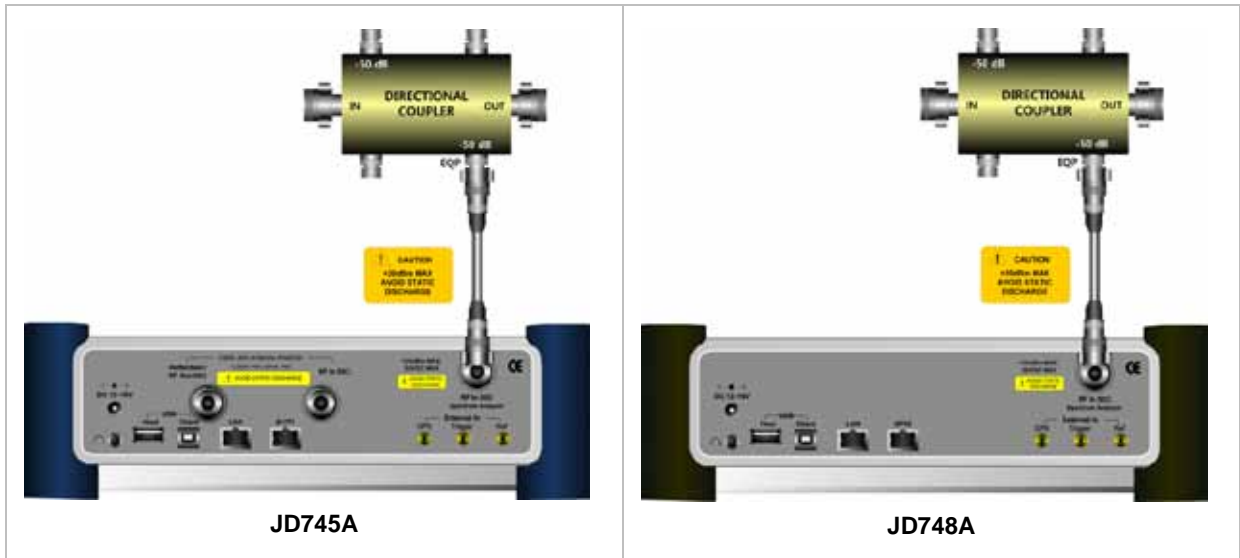

Over The Air (OTA)

Connect an Omni/directional RF antenna to the **Spectrum Analyzer RF In 50 Ω** port of the JD740A series and then a GPS antenna to the **GPS** port of the JD740A series.

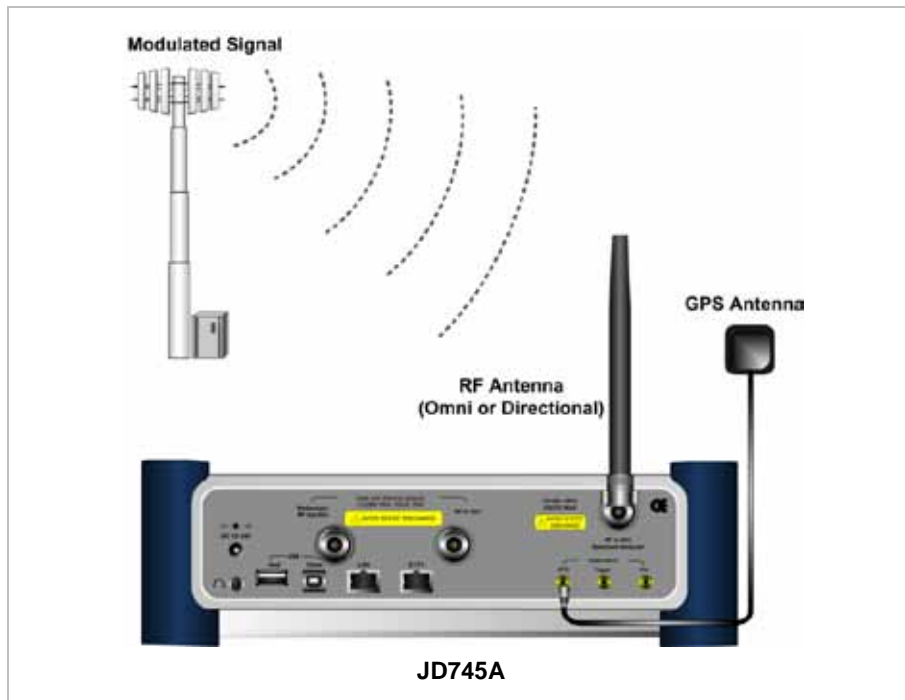

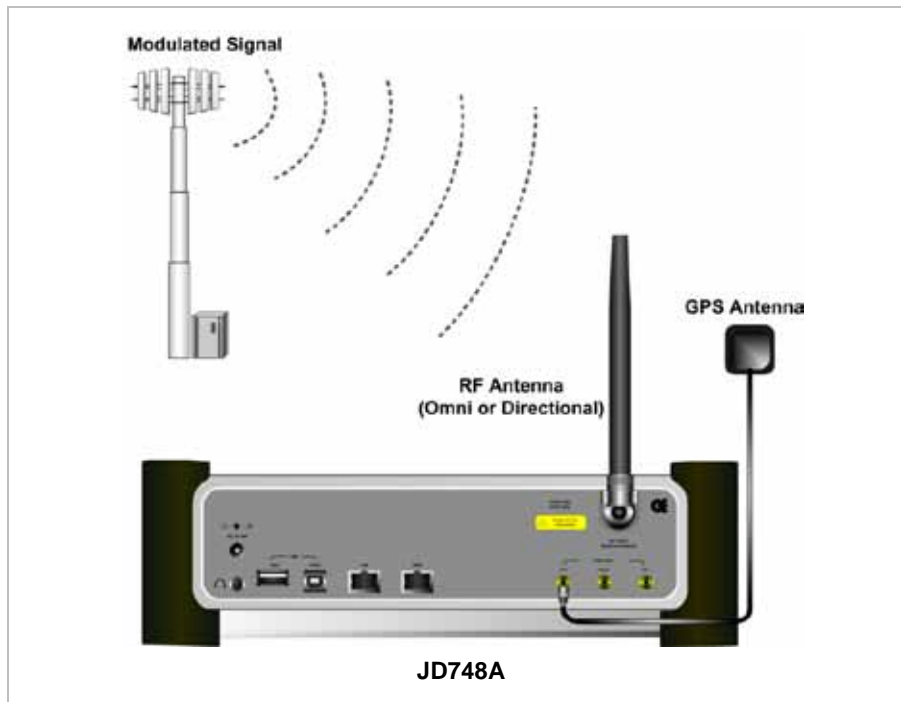

 If the input signal level to be measured is less than 0 dBm, set 0 dB attenuation or turn on the preamp to have better dynamic range for the OTA testing.

SPECTRUM ANALYSIS MEASUREMENT

Setting Mode

| Step | Description |
|---|--|
| 1. Connect the cable | Connect a cable directly or indirectly as shown in the section Connecting a Cable on page 7 of this chapter. |
| 2. Select the mode MODE [Signal Analyzer] [CDMA] [Spectrum] | Press the MODE hard key. Press the Signal Analyzer soft key. Press the CDMA soft key. Press the Spectrum soft key. (Spectrum mode is set by default.) |

Setting Frequency

| Step | Description |
|---|--|
| <p>1. Set the frequency</p> <p>FREQ/DIST</p> <p>[Unit] <Freq> or <Channel></p> <p><i>When Freq is selected:</i></p> <p>[Center Frequency] Enter a value [GHz], [MHz], [kHz], or [Hz]</p> <p><i>When Channel is selected:</i></p> <p>[Channel Standard] Select a channel standard</p> <p>[Select] or ENTER</p> <p>[Channel Number] Enter a value [Forward]</p> | <p>Press the FREQ/DIST hard key.</p> <p>Press the Unit soft key. Toggle this key between Freq and Channel. A set of Freq/Dist screen menu changes accordingly.</p> <p>Press the Center Frequency soft key. Use the numeric keys, the rotary knob, or the arrow keys. When using the numeric keys, the input is completed by selecting one of the unit soft keys.</p> <p>Press the Channel Standard soft key. Press the arrow keys, rotate the knob, or press the Page Up and Page Down soft keys to highlight a frequency band to select.</p> <p>Press the Select soft key or the ENTER hard key.</p> <p>Press the Channel Number soft key. Use the numeric keys to input value and press the Forward soft key to complete the input. The instrument automatically displays its corresponding center frequency value for the channel number.</p> |

FREQ/DIST



- n **UNIT:** Determines the way how to set the frequency band either with standard band or custom frequency band. Toggling this key between **Freq** and **Channel** changes a set of Freq/Dist screen menu automatically.
- n **CENTER FREQUENCY:** Changes the center frequency setting. Use the rotary knob or the arrow keys. Or use the numeric keys to input a certain value and press one of the unit soft keys to complete the input.
- n **FREQUENCY STEP:** Defines the amount of frequency to be increased or decreased when using the rotary knob or the arrow keys to change the **Center Frequency**. This frequency step size can be entered by using numeric keys and the unit soft keys.
- n **CHANNEL NUMBER:** Enters a channel number. The instrument automatically displays its

corresponding center frequency value for the channel number.

- n **CHANNEL STEP:** Defines the amount of channel to be increased or decreased when using the rotary knob or the arrow keys to change the **Channel Number**. This channel step size can be entered by using numeric keys and the **Enter** soft key.
- n **CHANNEL STANDARD:** When the channel standard is selected from the list, the center frequency information on the display screen will be mapped accordingly to the selected channel standard. The channel standards available in the instrument are listed in the table in the Appendix C – Band, Frequency & Channel Standard.

Setting Amplitude

| Step | Description |
|--|---|
| 1. Set the reference/attenuation level AMP/SCALE [Auto Scale] or [Reference Level] Enter a reference level value [dBm] or ENTER [Attenuation] <Auto> or <Manual> Enter an attenuation value | Press the AMP/SCALE hard key. Press the Auto Scale soft key to automatically set optimum levels of reference and attenuation. Press the Reference Level soft key to set manually. Use the numeric keys or the rotary knob that changes in a 10 dB step. Press the dBm soft key or the ENTER hard key. Press the Attenuation soft key. The Auto mode is set by default. This key toggles between the Auto and Manual . Press the Attenuation soft key to highlight the Manual mode and change the attenuation value to optimize S/N. Use the numeric keys or the rotary knob that changes in a 5 dB step. The attenuation setting range is 0 to 50 dB. |

AMP/SCALE



- n **AUTO SCALE:** The instrument can automatically set the scale to the minimum and maximum values on the Y-axis of the graph for optimum display of the traces measured. Each time the **Auto Scale** is selected, the top and bottom scales are set to the minimum and maximum values with margin on the Y-axis of the display screen and attenuation is set to its optimum value.
- n **REFERENCE LEVEL:** Sets the maximum Y-axis range.
- n **SCALE/DIV:** Is used only for the Spectrum measurement screen. It represents the value of one division on the horizontal scale. The default value is 10 dB per division and the Y-Scale is set to

100 dB. Selecting the **Scale/Div** soft key enables to set the value to 1 dB per division with the numeric keys or the rotary knob.

n **ATTENUATION**

Y **AUTO:** Input attenuator's value is automatically set depending on the reference level. This is the default operation mode, so it is recommended to use this mode unless a special measurement condition is needed.

Y **MANUAL:** Sets the attenuator's value for the **Spectrum Analyzer RF In 50 Ω** port.

n **PREAMP:** Turns on or off the internal pre-amplifier. Preamp results in a correction being applied to compensate for the gain of the preamp so that amplitude readings show the value at the input connector. This soft key toggles between the **On** and **Off**. When it is set to On, the allowable attenuation input range is from 0 dB to 10 dB in a multiple of 5. If the attenuation value is manually set greater than 10 dB, the instrument will automatically turn off the pre-amplifier to display low level signal properly on the screen.

n **UNITS:** Sets the scale unit on the display among **dBm**, **dBV**, **dBmV**, **dBuV**, **V**, and **W**.

n **EXTERNAL OFFSET:** Sets an external offset value. An offset consists of a cable loss and a user offset and the measurement result shows the value reflecting both offset values. When the external offset value is set at 40 dB in the Spectrum mode, the measurement result compensates 40 dB at both the Spectrum Analyzer and Signal Analyzer modes.

Setting Averaging



n **AVERAGE:** Sets the number of measurements to be averaged for the trace presentation. A maximum of 100 times of averaging can be set.

| Step | Description |
|---|--|
| 1. Set the averaging BW/AVG [Average] | Press the BW/AVG hard key. Press the Average soft key. |
| 2. Enter number of averaging to set | Use the numeric keys and input a number between 1 and 100. When the averaging reaches to the number set here, a new measurement value replaces the earliest measurement value in sequence. |
| 3. [Enter] or ENTER | Press the Enter soft key or the ENTER hard key. |

Setting Sweep Mode

SWEEP

This hot key is used to set the sweep parameters. The user input window must be inactive first to get the Sweep hot key function other than the number input.

- n **SWEEP MODE:** Sets the sweep method. Toggle between **Continue** and **Single**.

| Step | Description |
|--|---|
| 1. Set the sweep mode SWEEP [Sweep Mode] | Press the SWEEP hot key. Press the Sweep Mode soft key. Toggle between Continue and Single . |

Setting Trigger Source

TRIGGER

This hot key is used to select the trigger source among **Internal**, **External**, and **GPS**. The user input window must be inactive first to get the Trigger hot key function other than the number input.

Setting External Clock

To enhance the reliability of modulation analysis measurements the JD740A series must be synchronized with the Base Station. When an external clock is not supplied, the JD740A series works with a built-in internal high-accuracy time base. In this case, some measurement results may exhibit inaccurate values. Therefore, it is highly recommended to use the same reference clock as signal source. Trigger mode can be changed by using the **TRIGGER** hot key.

EXTERNAL CLOCK OPERATING STANDARDS

| Clock | Type | Reference | Port | Switching Standard |
|--------------------|----------|--------------------|---------------|--|
| External Reference | Internal | Internal 10 MHz | | Default |
| | External | External Ref Clock | Ext Ref (SMA) | Manual switching (Input signal level >-3 dBm) |
| | GPS | GPS Clock | GPS (SMA) | Automatic switching (GPS signal received) |
| Trigger | Internal | Internal Trigger | | Default |

| | | | | |
|--|----------|------------------|---------------|------------------|
| | External | External Trigger | Trigger (SMA) | Manual switching |
| | GPS | GPS | GPS (SMA) | Manual switching |

CONNECTION

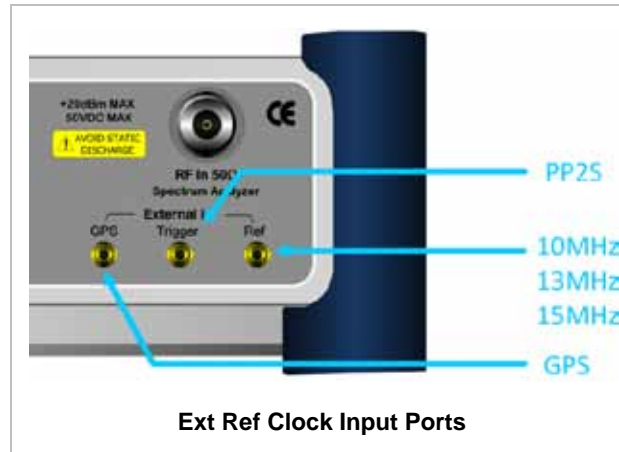



ENABLING EXTERNAL REFERENCE

| Step | Description |
|--|--|
| 1. Connect an external reference | Connect one of the external references or a GPS antenna to the JD740A series. |
| 2. Change reference clock SYSTEM [Frequency Reference] [External 10 MHz], [External 13 MHz], [External 15 MHz] or [GPS] | Press the SYSTEM hot key. Press the Frequency Reference soft key to select one of the external reference clocks or GPS. Press one of the soft keys to choose among External 10 MHz , External 13 MHz , External 15 MHz , and GPS . |

EXTERNAL REFERENCE INDICATOR INFORMATION

Each indicator tells different locking status according to a connection. When a GPS antenna is connected, longitude and latitude information will be displayed on the screen.

| Type | Indicator | Description |
|----------|-----------|-------------|
| Internal | (Green) | Locked |
| External | (Green) | Locked |
| | (Red) | Unlocked |

| | | |
|-----|--|----------------------------------|
| GPS |  (Green) | Locked |
| |  (Yellow) | Locking in progress |
| |  (Gray) | Unable to lock or antenna failed |

Setting Trace and Display

TRACE/DISPLAY

- n **SELECT TRACE:** Selects an active trace from T1 to T6. Trace numbers are assigned to each captured trace or loaded trace. Pressing one of the 6 trace number soft keys sets the selected trace number as the active trace on the display screen.
- n **CLEAR WRITE:** Clears the selected trace and writes or assigns the current trace.
- n **MAX HOLD:** Sets the active trace to display the maximum response of the input signal. Active trace compares newly acquired data with the trace shown on the screen and displays the bigger trace on the display screen.
- n **MIN HOLD:** Sets the active trace to display the minimum response of the input signal. Active trace compares newly acquired data with the trace shown on the screen and displays the smaller trace on the display screen.
- n **CAPTURE:** Captures a current trace on the display screen with the selected trace number.
- n **TRACE VIEW:** Displays the trace of the selected trace number on the display screen or hides it from the display screen. Press the **Select Trace** soft key to select a trace number and then press the **Trace View** soft key to toggle between the **Off** to hide and **On** to restore a hidden trace.
- n **TRACE CLEAR ALL:** Deletes all traces from the instrument and initializes the trace settings.

Measurement Procedure

| Step | Description |
|--|--|
| 1. Select the measurement mode MEASURE [Spectrum] | Press the MEASURE hot key. Press the Spectrum soft key. |

CDMA Spectrum Measurement Procedure

Measurement Example

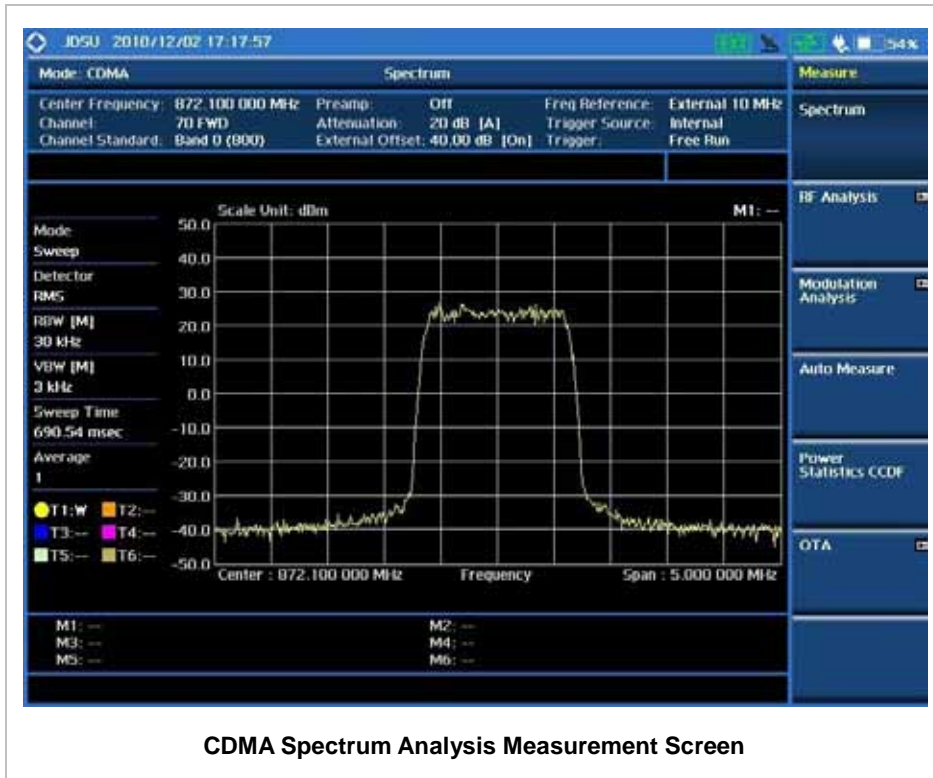

RF ANALYSIS MEASUREMENTS

RF Analysis in CDMA Signal Analyzer provides single-button measurements for the following measurements.

- n Channel Power
- n Occupied Bandwidth
- n Spectrum Emission Mask
- n Adjacent Channel Power Ratio (ACPR)
- n Multi-ACPR
- n Spurious Emissions

Setting Mode

| Step | Description |
|----------------------|--|
| 1. Connect the cable | Connect a cable directly or indirectly as shown in the |

| | |
|--|---|
| | section Connecting a Cable on page 7 of this chapter. |
| <p>2. Select the mode</p> <p>MODE</p> <p> [Signal Analyzer]</p> <p> [CDMA]</p> <p> [RF Analysis]</p> <p> [Channel Power],</p> <p> [Occupied BW],</p> <p> [Spectrum Emission Mask],</p> <p> [ACPR],</p> <p> [Multi-ACPR], or</p> <p> [Spurious Emissions]</p> | <p>Press the MODE hard key.</p> <p>Press the Signal Analyzer soft key.</p> <p>Press the CDMA soft key.</p> <p>Press the RF Analysis soft key.</p> <p>Press one of the measurement mode soft keys to select.</p> |

Setting Frequency

This setting is not used in the Multi-ACPR mode and the Spurious Emissions mode.

| Step | Description |
|--|---|
| <p>1. Set the frequency</p> <p>FREQ/DIST</p> <p> [Unit]</p> <p> <Freq> or <Channel></p> <p> </p> <p><u>When Freq is selected:</u></p> <p> [Center Frequency]</p> <p> Enter a value</p> <p> [GHz], [MHz], [kHz], or [Hz]</p> <p> </p> <p><u>When Channel is selected:</u></p> <p> [Channel Standard]</p> <p> Select a channel standard</p> <p> </p> <p> [Select] or ENTER</p> <p> </p> <p> [Channel Number]</p> <p> Enter a value</p> <p> [Forward]</p> | <p>Press the FREQ/DIST hard key.</p> <p>Press the Unit soft key. Toggle this key between Freq and Channel. A set of Freq/Dist screen menu changes accordingly.</p> <p> </p> <p>Press the Center Frequency soft key.</p> <p>Use the numeric keys, the rotary knob, or the arrow keys.</p> <p>When using the numeric keys, the input is completed by selecting one of the unit soft keys.</p> <p> </p> <p>Press the Channel Standard soft key.</p> <p>Press the arrow keys, rotate the knob, or press the Page Up and Page Down soft keys to highlight a frequency band to select.</p> <p>Press the Select soft key or the ENTER hard key.</p> <p> </p> <p>Press the Channel Number soft key.</p> <p>Use the numeric keys to input value and press the Forward soft key to complete the input. The instrument automatically displays its corresponding center frequency value for the channel number.</p> |

FREQ/DIST



- n **UNIT:** Determines the way how to set the frequency band either with standard band or custom frequency band. Toggling this key between **Freq** and **Channel** changes a set of Freq/Dist screen menu automatically.
- n **CENTER FREQUENCY:** Changes the center frequency setting. Use the rotary knob or the arrow keys. Or use the numeric keys to input a certain value and press one of the unit soft keys to complete the input.
- n **FREQUENCY STEP:** Defines the amount of frequency to be increased or decreased when using the rotary knob or the arrow keys to change the **Center Frequency**. This frequency step size can be entered by using numeric keys and the unit soft keys.
- n **CHANNEL NUMBER:** Enters a channel number. The instrument automatically displays its corresponding center frequency value for the channel number.
- n **CHANNEL STEP:** Defines the amount of channel to be increased or decreased when using the rotary knob or the arrow keys to change the **Channel Number**. This channel step size can be entered by using numeric keys and the **Enter** soft key.
- n **CHANNEL STANDARD:** When the channel standard is selected from the list, the center frequency information on the display screen will be mapped accordingly to the selected channel standard. The channel standards available in the instrument are listed in the Appendix C – Band, Frequency & Channel Standard.

Setting Amplitude

| Step | Description |
|---|---|
| 1. Set the reference/attenuation level AMP/SCALE [Auto Scale] or [Reference Level] Enter a reference level value [dBm] or ENTER [Attenuation] | Press the AMP/SCALE hard key. Press the Auto Scale soft key to automatically set optimum levels of reference and attenuation. Press the Reference Level soft key to set manually. Use the numeric keys or the rotary knob that changes in a 10 dB step. Press the dBm soft key or the ENTER hard key. Press the Attenuation soft key. The Auto mode is set by default. This key toggles between the Auto and Manual . |

| | |
|---|---|
| <p><Manual></p> <p>Enter an attenuation value</p> | <p>Press the Attenuation soft key to highlight the Manual mode and change the attenuation value to optimize S/N.</p> <p>Use the numeric keys or the rotary knob that changes in a 5 dB step. The attenuation setting range is 0 to 50 dB.</p> |
|---|---|

AMP/SCALE



- n **AUTO SCALE:** The instrument can automatically set the scale to the minimum and maximum values on the Y-axis of the graph for optimum display of the traces measured. Each time the **Auto Scale** is selected, the top and bottom scales are set to the minimum and maximum values with margin on the Y-axis of the display screen.
- n **REFERENCE LEVEL:** Sets the maximum Y-axis range.
- n **SCALE/DIV:** Is used only for the Spectrum measurement screen. It represents the value of one division on the horizontal scale. The default value is 10 dB per division and the Y-Scale is set to 100 dB. Selecting the **Scale/Div** soft key enables to set the value to 1 dB per division with the numeric keys or the rotary knob.
- n **ATTENUATION**
 - Y **AUTO:** Input attenuator's value is automatically set depending on the reference level. This is the default operation mode, so it is recommended to use this mode unless a special measurement condition is needed.
 - Y **MANUAL:** Sets the attenuator's value for the **Spectrum Analyzer RF In 50 Ω** port.
- n **PREAMP:** Turns on or off the internal pre-amplifier. Preamp results in a correction being applied to compensate for the gain of the preamp so that amplitude readings show the value at the input connector. This soft key toggles between the **On** and **Off**. When it is set to On, the allowable attenuation input range is from 0 dB to 10 dB in a multiple of 5. If the attenuation value is manually set greater than 10 dB, the instrument will automatically turn off the pre-amplifier to display low level signal properly on the screen.
- n **UNITS:** Sets the scale unit on the display among **dBm**, **dBV**, **dBmV**, **dBuV**, **V**, and **W**.
- n **EXTERNAL OFFSET:** Sets an external offset value. An offset consists of a cable loss and a user offset and the measurement result shows the value reflecting both offset values. When the external offset value is set at 40 dB in the Spectrum mode, the measurement result compensates 40 dB at both the Spectrum Analyzer and Signal Analyzer modes.

Setting Averaging

BW/AVG



- n **AVERAGE:** Sets the number of measurements to be averaged for the trace presentation. A maximum of 100 times of averaging can be set.

| Step | Description |
|---|---|
| 1. Set the averaging BW/AVG [Average] | Press the BW/AVG hard key. Press the Average soft key. |
| 2. Enter number of averaging to set | Use the numeric keys and input a number between 1 and 100. When the averaging reaches to the number set here, a new measurement value replaces the earliest measurement value in sequence. |
| 3. [Enter] or ENTER | Press the Enter soft key or the ENTER hard key. |

Setting Sweep Mode

SWEEP



This hot key is used to set the sweep parameters. The user input window must be inactive first to get the Sweep hot key function other than the number input.

- n **SWEEP MODE:** Sets the sweep method. Toggle between **Continue** and **Single**.

| Step | Description |
|--|---|
| 1. Set the sweep mode SWEEP [Sweep Mode] | Press the SWEEP hot key. Press the Sweep Mode soft key. Toggle between Continue and Single . |

Setting Trigger Source

TRIGGER



This hot key is used to select the trigger source among **Internal**, **External**, and **GPS**. The user input window must be inactive first to get the Trigger hot key function other than the number input.

Setting External Clock

To enhance the reliability of modulation analysis measurements the JD740A series must be synchronized with the Base Station. When an external clock is not supplied, the JD740A series works

with a built-in internal high-accuracy time base. In this case, some measurement results may exhibit inaccurate values. Therefore, it is highly recommended to use the same reference clock as signal source. Trigger mode can be changed by using the **TRIGGER** hot key.

EXTERNAL CLOCK OPERATING STANDARDS

| Clock | Type | Reference | Port | Switching Standard |
|--------------------|----------|--------------------|---------------|--|
| External Reference | Internal | Internal 10 MHz | | Default |
| | External | External Ref Clock | Ext Ref (SMA) | Manual switching (Input signal level >-3 dBm) |
| | GPS | GPS Clock | GPS (SMA) | Automatic switching (GPS signal received) |
| Trigger | Internal | Internal Trigger | | Default |
| | External | External Trigger | Trigger (SMA) | Manual switching |
| | GPS | GPS | GPS (SMA) | Manual switching |

CONNECTION

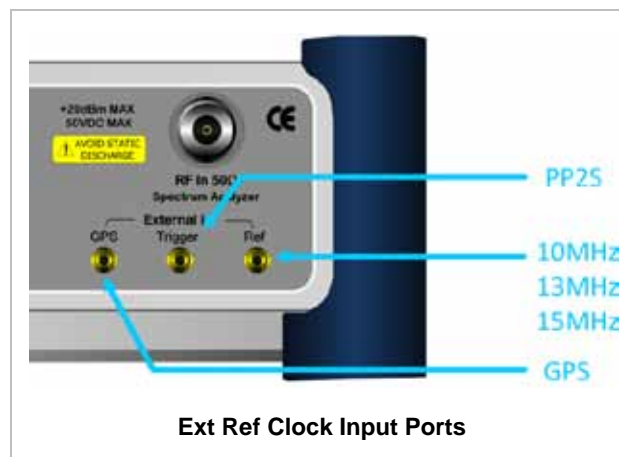

ENABLING EXTERNAL REFERENCE

| Step | Description |
|--|--|
| 1. Connect an external reference | Connect one of the external references or a GPS antenna to the JD740A series. |
| 2. Change reference clock SYSTEM [Frequency Reference] | Press the SYSTEM hot key. Press the Frequency Reference soft key to select one of the external reference clocks or GPS. |

| | |
|---|---|
| <p>[External 10 MHz], [External 13 MHz], [External 15 MHz] or [GPS]</p> | <p>Press one of the soft keys to choose among External 10 MHz, External 13 MHz, External 15 MHz, and GPS.</p> |
|---|---|

EXTERNAL REFERENCE INDICATOR INFORMATION

Each indicator tells different locking status according to a connection. When a GPS antenna is connected, longitude and latitude information will be displayed on the screen.

| Type | Indicator | Description |
|----------|--|----------------------------------|
| Internal |  (Green) | Locked |
| External |  (Green) | Locked |
| |  (Red) | Unlocked |
| GPS |  (Green) | Locked |
| |  (Yellow) | Locking in progress |
| |  (Gray) | Unable to lock or antenna failed |

CHANNEL POWER

The Channel Power measurement is a common test used in the wireless industry to measure the total transmitted power of a radio within a defined frequency channel. It acquires a number of points representing the input signal in the time domain, transforms this information into the frequency domain using Fast Fourier Transform (FFT) and then calculates the channel power. The effective resolution bandwidth of the frequency domain trace is proportional to the number of points acquired for the FFT.

The channel power measurement identifies the total RF power, power spectral density (PSD) and peak to average ratio (PAR) of the signal within the channel bandwidth (1.23 MHz for cdmaOne).

Measurement Procedure

| Step | Description |
|--|---|
| <p>1. Set the measurement mode MEASURE [RF Analysis]</p> | <p>Press the MEASURE hot key. Press the RF Analysis soft key.</p> |

[Channel Power]

Press the **Channel Power** soft key.

CDMA Channel Power Measurement Procedure

Setting Limit



This hot key is used to set the threshold value for the limit line on the display screen. It turns on or off the limit or band limit settings of the measurement for pass/fail indication. The user input window must be inactive first to get the Limit hot key function other than the number input.

| Step | Description |
|---|---|
| 1. Select the limit LIMIT [RF Test Limits] [Channel Power] [Test Limits] <On> or <Off> [High Limit] Enter a value [dBm] or ENTER [Low Limit] Enter a value [dBm] or ENTER | Press the LIMIT hot key. Press the RF Test Limits soft key. Press the Channel Power soft key. Press the Test Limits soft key to toggle between On and Off and select one. Press the High Limit soft key to set the upper limit of the Pass/Fail criteria. Use the numeric keys to input value. Press the unit soft key or the ENTER hard key. Press the Low Limit soft key to set the lower limit of the Pass/Fail criteria. Use the numeric keys to input value. Press the unit soft key or the ENTER hard key. |
| 2. Enable beep LIMIT [Beep] <On> or <Off> | Press the LIMIT hot key. Press the Beep soft key to toggle between On and Off and select one. This will make audible alarm if the measurement result goes beyond the limit. |

- n **TEST LIMITS:** Enables or disables Pass/Fail results on the display screen. Toggle the **Test Limits** soft key to set it to **On** or **Off**.
- n **HIGH LIMIT:** Sets the upper limit of the Pass/Fail criteria. Use the numeric keys to enter a threshold or limit value and press the **dBm** unit soft key or the **ENTER** hard key.
- n **LOW LIMIT:** Sets the lower limit of the Pass/Fail criteria. Use the numeric keys to enter a threshold or limit value and press the **dBm** unit soft key or the **ENTER** hard key.

Measurement Example

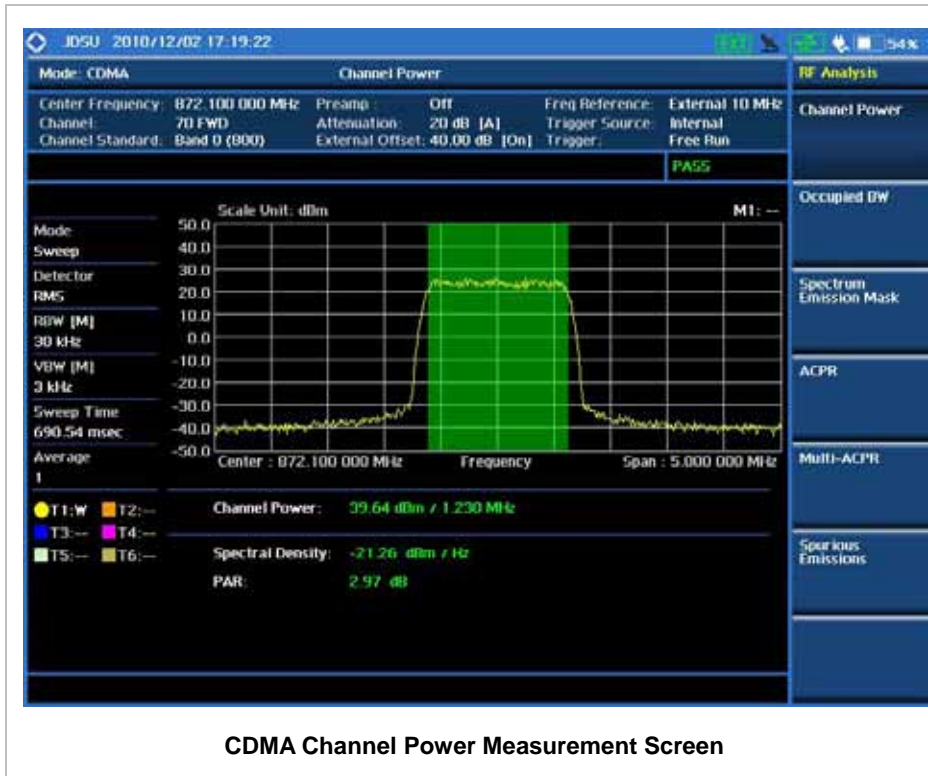

OCCUPIED BANDWIDTH

The Occupied Bandwidth measures the spectrum shape of the carrier. It is defined as the bandwidth which includes 99% of the transmitted power among total transmitted power.

Measurement Procedure

| Step | Description |
|---|---|
| 1. Set the measurement mode MEASURE [RF Analysis] [Occupied BW] | Press the MEASURE hot key. Press the RF Analysis soft key. Press the Occupied BW soft key. |

CDMA Occupied BW Measurement Procedure

Setting Limit



This hot key is used to set the threshold value for the limit line on the display screen. It turns on or off the limit or band limit settings of the measurement for pass/fail indication. The user input window must be inactive first to get the Limit hot key function other than the number input.

| Step | Description |
|---|--|
| 1. Select the limit LIMIT [RF Test Limits] [Occupied BW] [Test Limit] <On> or <Off> [High Limit] Enter a value [MHz], [kHz], or [Hz] | Press the LIMIT hot key. Press the RF Test Limits soft key. Press the Occupied BW soft key. Press the Test Limit soft key to toggle between On and Off and select one. Press the High Limit soft key to set the upper limit of the Pass/Fail criteria. Use the numeric keys to input value. Press the unit soft key to select. |
| 2. Enable beep LIMIT [Beep] <On> or <Off> | Press the LIMIT hot key. Press the Beep soft key to toggle between On and Off and select one. This will make audible alarm if the measurement result goes beyond the limit. |

- n **TEST LIMIT:** Enables or disables Pass/Fail results on the display screen. Toggle the **Test Limit** soft key to set it to **On** or **Off**.
- n **HIGH LIMIT:** Sets the upper limit of the Pass/Fail criteria. Use the numeric keys to enter a threshold or limit value and press one of the unit soft keys to complete the input.

Measurement Example

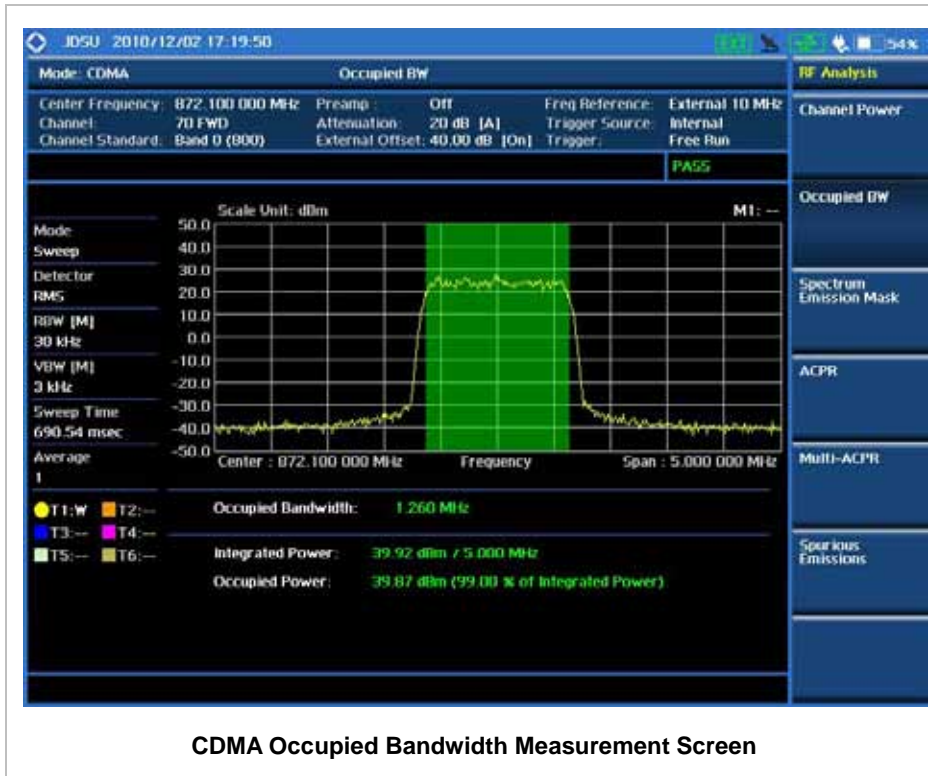

SPECTRUM EMISSION MASK (SEM)

The Spectrum Emission Mask (SEM) measurement required by 3GPP2 specifications encompasses different power limits and different measurement bandwidths (resolution bandwidths) at various frequency offsets. It may be expressed as a ratio of power spectral densities between the carrier and the specified offset frequency band. It provides useful figures-of-merit for the spectral re-growth and emissions produced by components and circuit blocks, without the rigor of performing a full SEM measurement.

The SEM measures spurious signal levels in up to five pairs of offset or region frequencies and relates them to the carrier power.

Measurement Procedure

| Step | Description |
|--|--|
| 1. Set the measurement mode MEASURE [RF Analysis] [Spectrum Emission Mask] | Press the MEASURE hot key. Press the RF Analysis soft key. Press the Spectrum Emission Mask soft key. |

CDMA Spectrum Emission Mask Measurement Procedure

Setting Limit



This hot key is used to set the threshold value for the limit line on the display screen. It turns on or off the limit or band limit settings of the measurement for pass/fail indication. The user input window must be inactive first to get the Limit hot key function other than the number input.

| Step | Description |
|--|--|
| 1. Select the limit LIMIT [RF Test Limits] [Spectrum Emission Mask] [Test Limit] <On> or <Off> | Press the LIMIT hot key. Press the RF Test Limits soft key. Press the Spectrum Emission Mask soft key. Press the Test Limit soft key to toggle between On and Off and select one. |
| 2. Enable beep LIMIT [Beep] <On> or <Off> | Press the LIMIT hot key. Press the Beep soft key to toggle between On and Off and select one. This will make audible alarm if the measurement result goes beyond the limit. |

- n **TEST LIMIT:** Enables or disables Pass/Fail results on the display screen. Toggle the **Test Limit** soft key to set it to **On** or **Off**.

Measurement Example

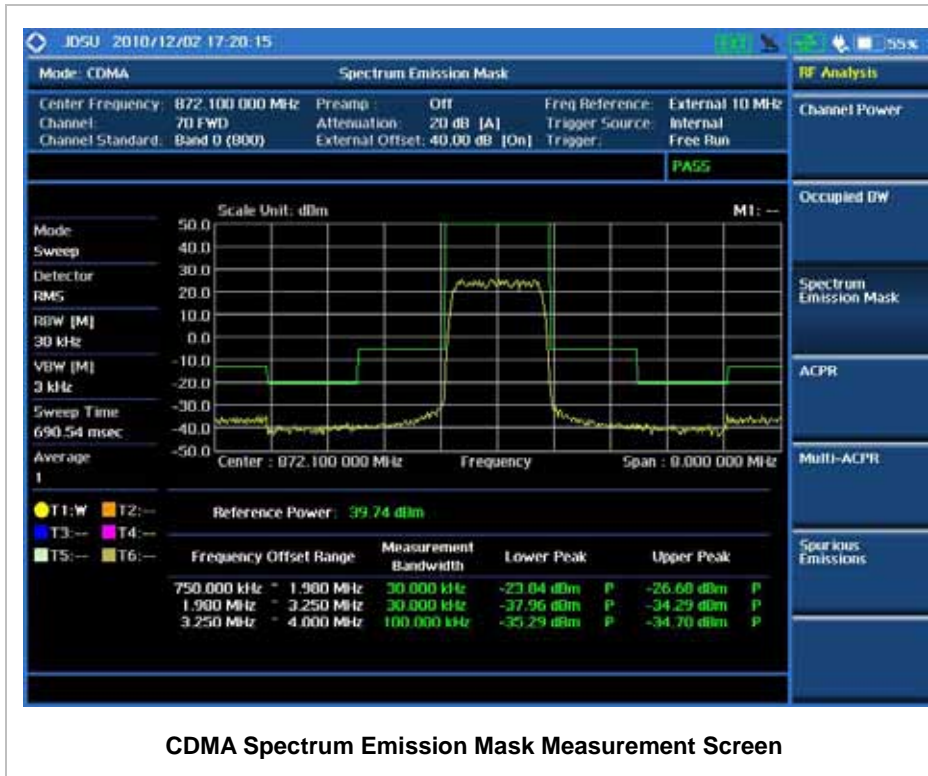

ACPR

The Adjacent Channel Power Ratio (ACPR) is defined as the ratio of the average power in the adjacent frequency channel (or offset) to the average power in the transmitted frequency channel. It may be expressed as the ratio of the integrated signal power in the adjacent channel to the integrated signal power in the main channel.

Measurement Procedure

| Step | Description |
|--|--|
| 1. Set the measurement mode MEASURE [RF Analysis] [ACPR] | Press the MEASURE hot key. Press the RF Analysis soft key. Press the ACPR soft key. |

CDMA ACPR Measurement Procedure

Setting Limit



This hot key is used to set the threshold value for the limit line on the display screen. It turns on or off the limit or band limit settings of the measurement for pass/fail indication. The user input window must be inactive first to get the Limit hot key function other than the number input.

| Step | Description |
|--|--|
| 1. Select the limit LIMIT [RF Test Limits] [ACPR] [Test Limit] <On> or <Off> | Press the LIMIT hot key. Press the RF Test Limits soft key. Press the ACPR soft key. Press the Test Limit soft key to toggle between On and Off and select one. |
| 2. Enable beep LIMIT [Beep] <On> or <Off> | Press the LIMIT hot key. Press the Beep soft key to toggle between On and Off and select one. This will make audible alarm if the measurement result goes beyond the limit. |

- n **TEST LIMIT:** Enables or disables Pass/Fail results on the display screen. Toggle the **Test Limit** soft key to set it to **On** or **Off**.

Measurement Example

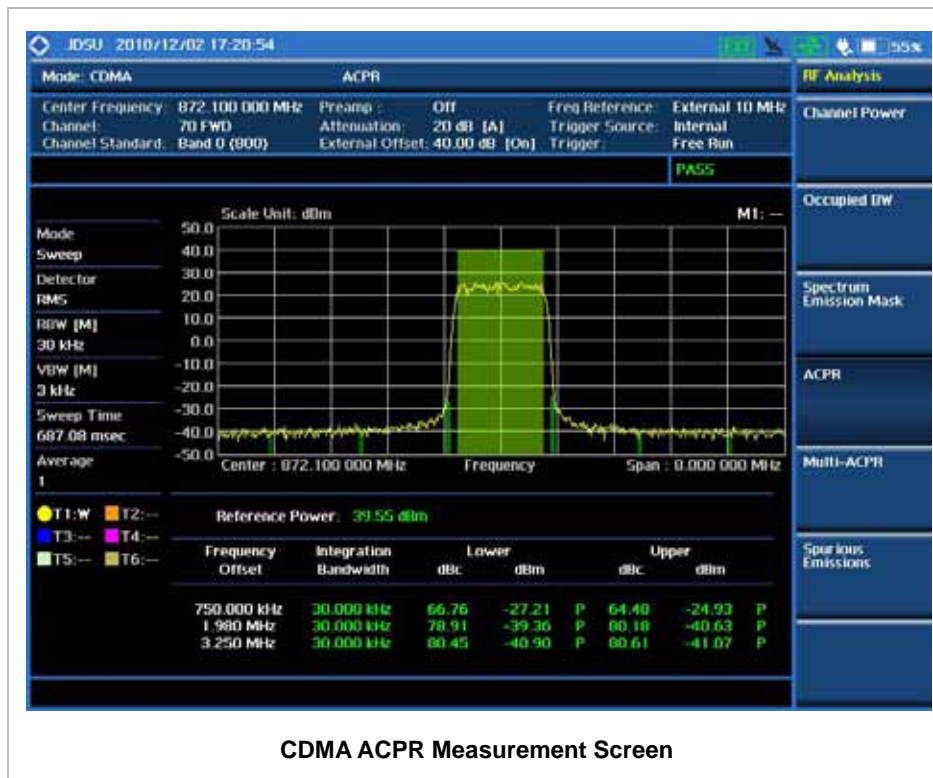

CDMA ACPR Measurement Screen

MULTI-ACPR

The Multi-ACPR measurement is used to perform multi-channel ACPR measurements with as many channels as possible. It helps the user to measure ACPR in multi-channel transmitting Base Station environment.

Measurement Procedure

| Step | Description |
|--|--|
| <p>1. Set the measurement mode</p> <p>MEASURE</p> <p>[RF Analysis]</p> <p>[Multi-ACPR]</p> | <p>Press the MEASURE hot key.</p> <p>Press the RF Analysis soft key.</p> <p>Press the Multi-ACPR soft key.</p> |
| <p>2. Set the measurement parameters</p> <p>MEASURE SETUP</p> <p>[Unit]</p> <p><Freq> or <Channel></p> <p><i>When Freq is selected:</i></p> <p>[Lowest Frequency]</p> <p>Enter a value</p> <p>[GHz], [MHz], [kHz], or [Hz]</p> <p>[Highest Frequency]</p> <p>Enter a value</p> <p>[GHz], [MHz], [kHz], or [Hz]</p> <p><i>When Channel is selected:</i></p> <p>[Channel Standard]</p> <p>Select a channel standard</p> <p>[Select] or ENTER</p> <p>[Lowest Channel]</p> <p>Enter a value</p> <p>[Forward]</p> <p>[Highest Channel]</p> <p>Enter a value</p> <p>[Forward]</p> | <p>Press the MEASURE SETUP hot key.</p> <p>Press the Unit soft key. Toggle this key between Freq and Channel. A set of Freq/Dist screen menu changes accordingly.</p> <p>Press the Lowest Frequency soft key.</p> <p>Use the numeric keys to input value.</p> <p>Press one of the unit soft keys to select.</p> <p>Press the Highest Frequency soft key.</p> <p>Use the numeric keys to input value.</p> <p>Press one of the unit soft keys to select.</p> <p>Press the Channel Standard soft key.</p> <p>Press the arrow keys, rotate the knob, or press the Page Up and Page Down soft keys to highlight a frequency band to select.</p> <p>Press the Select soft key or the ENTER hard key.</p> <p>Press the Lowest Channel soft key.</p> <p>Use the numeric keys to input value.</p> <p>Press the Forward soft key.</p> <p>Press the Highest Channel soft key.</p> <p>Use the numeric keys to input value.</p> <p>Press the Forward soft key.</p> |

CDMA Multi-ACPR Measurement Procedure

MEASURE SETUP



- n **UNIT:** Determines the way how to set the frequency band either with standard band or custom frequency band. Toggling this key between **Freq** and **Channel** changes a set of Freq/Dist screen menu automatically.
- n **LOWEST FREQUENCY:** Sets the center frequency of the far left end on the display. Use the numeric keys to enter a value and press one of the unit soft keys to complete the input.
- n **HIGHEST FREQUENCY:** Sets the center frequency of the far right end on the display. Use the numeric keys to enter a value and press one of the unit soft keys to complete the input.
- n **LOWEST CHANNEL:** Sets the channel number of the far left end on the display.
- n **HIGHEST CHANNEL:** Sets the channel number of the far right end on the display.
- n **CHANNEL STANDARD:** When the channel standard is selected from the list, the center frequency information on the display screen will be mapped accordingly to the selected channel standard. The channel standards available in the instrument are listed in the Appendix C – Band, Frequency & Channel Standard.

Setting Limit

LIMIT



This hot key is used to set the threshold value for the limit line on the display screen. It turns on or off the limit or band limit settings of the measurement for pass/fail indication. The user input window must be inactive first to get the Limit hot key function other than the number input.

| Step | Description |
|--|--|
| 1. Select the limit LIMIT [RF Test Limits] [Multi-ACPR] [Test Limit] <On> or <Off> | Press the LIMIT hot key. Press the RF Test Limits soft key. Press the Multi-ACPR soft key. Press the Test Limit soft key to toggle between On and Off and select one. |
| 2. Enable beep LIMIT [Beep] <On> or <Off> | Press the LIMIT hot key. Press the Beep soft key to toggle between On and Off and select one. This will make audible alarm if the measurement result goes beyond the limit. |

- n **TEST LIMIT:** Enables or disables Pass/Fail results on the display screen. Toggle the **Test Limit** soft key to set it to **On** or **Off**.

Measurement Example

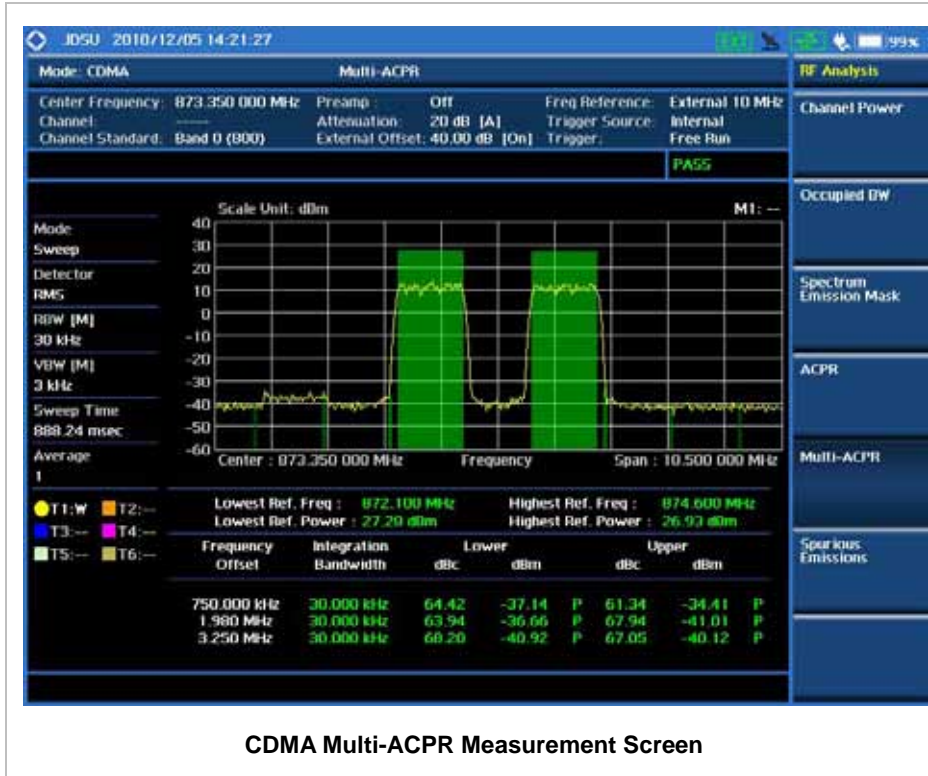

SPURIOUS EMISSIONS

Out-of-band emissions are unwanted emissions immediately outside the channel bandwidth resulting from the modulation process and non-linearity in the transmitter but excluding spurious emissions. The Spurious Emissions measurement is to identify and determine the power level of out-of-band spurious emission within the necessary channel bandwidth and modulated signal measured at the RF port of the Base Station.

Measurement Procedure

| Step | Description |
|---|-----------------------------------|
| 1. Set the measurement mode MEASURE | Press the MEASURE hot key. |

| | |
|--|--|
| <p>[RF Analysis] [Spurious Emissions]</p> | <p>Press the RF Analysis soft key. Press the Spurious Emissions soft key.</p> |
| <p>2. Set the measurement parameters MEASURE SETUP [Range Table] [Range] Enter a value [Enter] [Start Frequency] Enter a value [GHz], [MHz], [kHz], or [Hz] [Stop Frequency] Enter a value [GHz], [MHz], [kHz], or [Hz] [Start Limit] Enter a value [dBm] [Stop Limit] Enter a value [dBm] [Attenuation] Enter a value [dB] or ENTER [RBW] Enter a value [GHz], [MHz], [kHz], or [Hz] [VBW] Enter a value [GHz], [MHz], [kHz], or [Hz] [Measure Type] <Examine> or <Full> [Average] Enter a value [Enter] or ENTER</p> | <p>Press the MEASURE SETUP hot key. Press the Range Table soft key. Press the Range soft key. Use the numeric keys to select the range number. Press the Enter soft key. Press the Start Frequency soft key. Use the numeric keys. Press one of the unit soft keys to select. Press the Stop Frequency soft key. Use the numeric keys. Press one of the unit soft keys to select. Press the Start Limit soft key. Use the numeric keys. Press the unit soft key to complete the input. Press the Stop Limit soft key. Use the numeric keys. Press the unit soft key to complete the input. Press the Attenuation soft key. Use the numeric keys to enter input value in the multiple of 5. Press the dB unit soft key or the ENTER hard key. Press the RBW soft key. Use the numeric keys. Press one of the unit soft keys to select. Press the VBW soft key. Use the numeric keys. Press one of the unit soft keys to select. Press the Measure Type soft key to toggle between Examine and Full. Press the Average soft key. Use the numeric keys to enter a value. Press the Enter soft key or the ENTER hard key.</p> |

CDMA Spurious Emissions Measurement Procedure

MEASURE SETUP



Sets the measurement parameters including range table and measurement type. The measurement settings can be saved and recalled as a file. Also, JDViewer, PC application software allows the user

to set the parameters in the user's computer to import into the instrument.

- n **RANGE TABLE:** Sets the range table parameters.
 - Y **RANGE:** Adds a new range number or selects one of the existing range numbers to show or hide the particular frequency range in the range table at the bottom of the screen. Use the numeric keys to enter a range number and press the **Enter** soft key to complete the input. Each time the **Range** soft key is press, it toggles between **On** and **Off**.
 - Y **START FREQUENCY:** Sets or changes the start frequency value to be measured for the selected range number in the Range menu. Use the numeric keys to enter a value and press one of the unit soft keys.
 - Y **STOP FREQUENCY:** Sets or changes the stop frequency value to be measured for the selected range number in the Range menu. Use the numeric keys to enter a value and press one of the unit soft keys.
 - Y **START LIMIT:** Sets the start value of the limit line for the displayed range.
 - Y **STOP LIMIT:** Sets the stop value of the limit line for the displayed range.
 - Y **ATTENUATION:** Sets the attenuation value in the multiple of 5.
 - Y **RBW:** Sets the resolution bandwidth for the selected range number in the Range menu.
 - Y **VBW:** Sets the video bandwidth for the selected range number in the Range menu.
- n **MEASURE TYPE:** Sets the measurement type to **Examine** or **Full**. Toggle between **Examine** and **Full**. Examine mode will show selected range only. The instrument will automatically switch and show all ranges when Full is selected.
- n **RANGE:** Selects the range number to be displayed on the screen. This key is activated only when the **Measure Type** is set to **Examine** mode. Use the numeric keys to select one of the existing range numbers that are configured in the Range Table menu. Pressing the **Enter** soft key completes the input and changes the display.
- n **AVERAGE:** Sets the frequency the number of trace to be averaged.

Setting Limit



This hot key is used to set the threshold value for the limit line on the display screen. It turns on or off the limit or band limit settings of the measurement for pass/fail indication. The user input window must be inactive first to get the Limit hot key function other than the number input.

| Step | Description |
|--|--|
| 1. Select the limit LIMIT [RF Test Limits] [Spurious Emissions] [Test Limit] <On> or <Off> | Press the LIMIT hot key. Press the RF Test Limits soft key. Press the Spurious Emissions soft key. Press the Test Limit soft key to toggle between On and Off and select one. |
| 2. Enable beep LIMIT [Beep] <On> or <Off> | Press the LIMIT hot key. Press the Beep soft key to toggle between On and Off and select one. This will make audible alarm if the measurement result goes beyond the limit. |

- n **TEST LIMIT:** Enables or disables Pass/Fail results on the display screen. Toggle the **Test Limit** soft key to set it to **On** or **Off**.

Measurement Example

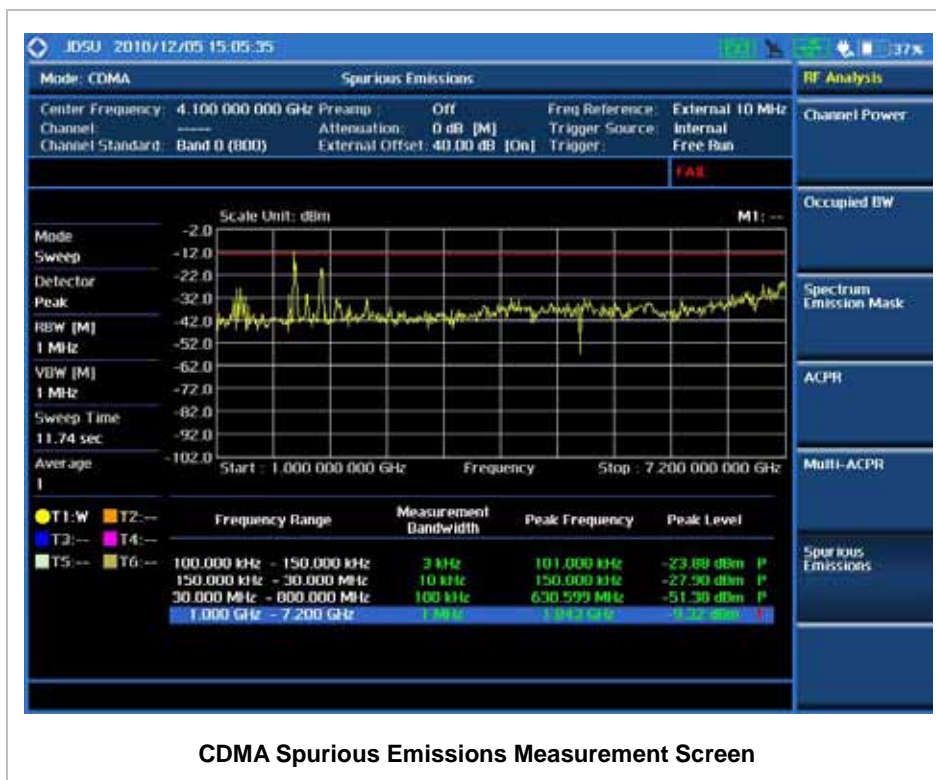

MODULATION ANALYSIS MEASUREMENTS

Modulation Analysis in CDMA Signal Analyzer provides single-button measurements for the following essential measurements.

- n Constellation
- n Code Domain Power (CDP)
- n Codogram
- n Received Code Strength Indicator (RCSI)
- n CDP Table

Setting Mode

| Step | Description |
|---|--|
| 1. Connect the cable | Connect a cable directly or indirectly as shown in the section Connecting a Cable on page 7 of this chapter. |
| 2. Select the mode MODE [Signal Analyzer] [CDMA] [Modulation Analysis] [Constellation], [Code Domain Power], [Codogram], [RCSI], or [CDP Table] | Press the MODE hard key. Press the Signal Analyzer soft key. Press the CDMA soft key. Press the Modulation Analysis soft key. Press one of the measurement mode soft keys to select. |

Setting Frequency

| Step | Description |
|---|--|
| 1. Set the frequency FREQ/DIST [Unit] <Freq> or <Channel> | Press the FREQ/DIST hard key. Press the Unit soft key. Toggle this key between Freq and Channel . A set of Freq/Dist screen menu changes accordingly. |

| | |
|--|--|
| <p><u>When Freq is selected:</u></p> <p>[Center Frequency] Enter a value [GHz], [MHz], [kHz], or [Hz]</p> | <p>Press the Center Frequency soft key. Use the numeric keys, the rotary knob, or the arrow keys. When using the numeric keys, the input is completed by selecting one of the unit soft keys.</p> |
| <p><u>When Channel is selected:</u></p> <p>[Channel Standard] Select a channel standard</p> <p>[Select] or ENTER</p> | <p>Press the Channel Standard soft key. Press the arrow keys, rotate the knob, or press the Page Up and Page Down soft keys to highlight a frequency band to select. Press the Select soft key or the ENTER hard key.</p> |
| <p>[Channel Number] Enter a value [Forward]</p> | <p>Press the Channel Number soft key. Use the numeric keys to input value and press the Forward soft key to complete the input. The instrument automatically displays its corresponding center frequency value for the channel number.</p> |

FREQ/DIST 

- n **UNIT:** Determines the way how to set the frequency band either with standard band or custom frequency band. Toggling this key between **Freq** and **Channel** changes a set of Freq/Dist screen menu automatically.
- n **CENTER FREQUENCY:** Changes the center frequency setting. Use the rotary knob or the arrow keys. Or use the numeric keys to input a certain value and press one of the unit soft keys to complete the input.
- n **FREQUENCY STEP:** Defines the amount of frequency to be increased or decreased when using the rotary knob or the arrow keys to change the **Center Frequency**. This frequency step size can be entered by using numeric keys and the unit soft keys.
- n **CHANNEL NUMBER:** Enters a channel number. The instrument automatically displays its corresponding center frequency value for the channel number.
- n **CHANNEL STEP:** Defines the amount of channel to be increased or decreased when using the rotary knob or the arrow keys to change the **Channel Number**. This channel step size can be entered by using numeric keys and the **Enter** soft key.
- n **CHANNEL STANDARD:** When the channel standard is selected from the list, the center frequency information on the display screen will be mapped accordingly to the selected channel standard. The channel standards available in the instrument are listed in the Appendix C – Band, Frequency & Channel Standard.

Setting Amplitude

| Step | Description |
|--|---|
| <p>1. Set the reference/attenuation level</p> <p>AMP/SCALE</p> <p>[Auto Scale]</p> <p>or</p> <p>[Reference Level]</p> <p>Enter a reference level value</p> <p>[dBm] or ENTER</p> <p>[Attenuation]</p> <p><Manual></p> <p>Enter an attenuation value</p> | <p>Press the AMP/SCALE hard key.</p> <p>Press the Auto Scale soft key to automatically set optimum levels of reference and attenuation.</p> <p>Press the Reference Level soft key to set manually. Use the numeric keys or the rotary knob that changes in a 10 dB step. Press the dBm soft key or the ENTER hard key.</p> <p>Press the Attenuation soft key. The Auto mode is set by default. This key toggles between the Auto and Manual. Press the Attenuation soft key to highlight the Manual mode and change the attenuation value to optimize S/N. Use the numeric keys or the rotary knob that changes in a 5 dB step. The attenuation setting range is 0 to 50 dB.</p> |

AMP/SCALE



- n **AUTO SCALE:** The instrument can automatically set the scale to the minimum and maximum values on the Y-axis of the graph for optimum display of the traces measured. Each time the **Auto Scale** is selected, the top and bottom scales are set to the minimum and maximum values with margin on the Y-axis of the display screen.
- n **REFERENCE:** Sets the display of measurement result to relative or absolute value. Toggle between **Abs** for absolute and **Rel** for relative. *This key is not used in the Constellation mode and the CDP Table mode.*
 - Y **ABS:** The code domain power is measured absolute to channel power.
 - Y **REL:** The code domain power is measured relative to channel power.
- n **REFERENCE LEVEL:** Sets the maximum Y-axis range. This key is activated only when the **Reference** is set to the **Abs** mode. *This key is not used in the Constellation mode and the CDP Table mode.*
- n **ATTENUATION**
 - Y **AUTO:** Input attenuator's value is automatically set depending on the reference level. This is the default operation mode, so it is recommended to use this mode unless a special

measurement condition is needed.

- Y **MANUAL:** Sets the attenuator's value for the **Spectrum Analyzer RF In 50 Ω** port.
- n **PREAMP:** Turns on or off the internal pre-amplifier. Preamp results in a correction being applied to compensate for the gain of the preamp so that amplitude readings show the value at the input connector. This soft key toggles between the **On** and **Off**. When it is set to On, the allowable attenuation input range is from 0 dB to 10 dB in a multiple of 5. If the attenuation value is manually set greater than 10 dB, the instrument will automatically turn off the pre-amplifier to display low level signal properly on the screen.
- n **EXTERNAL OFFSET:** Sets an external offset value. An offset consists of a cable loss and a user offset and the measurement result shows the value reflecting both offset values. When the external offset value is set at 40 dB in the Spectrum mode, the measurement result compensates 40 dB at both the Spectrum Analyzer and Signal Analyzer modes.

Setting Sweep Mode



This hot key is used to set the sweep parameters. The user input window must be inactive first to get the Sweep hot key function other than the number input.

- n **SWEEP MODE:** Sets the sweep method. Toggle between **Continue** and **Single**.

| Step | Description |
|--|---|
| 1. Set the sweep mode SWEEP [Sweep Mode] | Press the SWEEP hot key. Press the Sweep Mode soft key. Toggle between Continue and Single . |

Setting Trigger Source



This hot key is used to select the trigger source among **Internal**, **External**, and **GPS**. The user input window must be inactive first to get the Trigger hot key function other than the number input.

Setting External Clock

To enhance the reliability of modulation analysis measurements the JD740A series must be

synchronized with the Base Station. When an external clock is not supplied, the JD740A series works with a built-in internal high-accuracy time base. In this case, some measurement results may exhibit inaccurate values. Therefore, it is highly recommended to use the same reference clock as signal source. Trigger mode can be changed by using the **TRIGGER** hot key.

EXTERNAL CLOCK OPERATING STANDARDS

| Clock | Type | Reference | Port | Switching Standard |
|--------------------|----------|--------------------|---------------|--|
| External Reference | Internal | Internal 10 MHz | | Default |
| | External | External Ref Clock | Ext Ref (SMA) | Manual switching (Input signal level >-3 dBm) |
| | GPS | GPS Clock | GPS (SMA) | Automatic switching (GPS signal received) |
| Trigger | Internal | Internal Trigger | | Default |
| | External | External Trigger | Trigger (SMA) | Manual switching |
| | GPS | GPS | GPS (SMA) | Manual switching |

CONNECTION

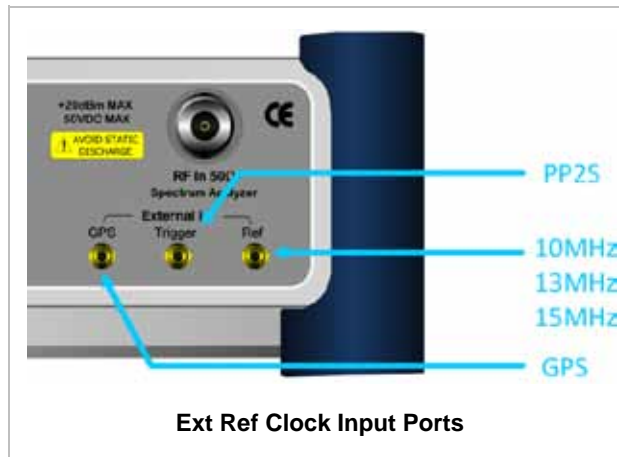

ENABLING EXTERNAL REFERENCE

| Step | Description |
|--|--|
| 1. Connect an external reference | Connect one of the external references or a GPS antenna to the JD740A series. |
| 2. Change reference clock SYSTEM [Frequency Reference] | Press the SYSTEM hot key. Press the Frequency Reference soft key to select one of the |

| | |
|---|---|
| <p>[External 10 MHz], [External 13 MHz], [External 15 MHz] or [GPS]</p> | <p>external reference clocks or GPS. Press one of the soft keys to choose among External 10 MHz, External 13 MHz, External 15 MHz, and GPS.</p> |
|---|---|

EXTERNAL REFERENCE INDICATOR INFORMATION

Each indicator tells different locking status according to a connection. When a GPS antenna is connected, longitude and latitude information will be displayed on the screen.

| Type | Indicator | Description |
|----------|---|----------------------------------|
| Internal |  (Green) | Locked |
| External |  (Green) | Locked |
| |  (Red) | Unlocked |
| GPS |  (Green) | Locked |
| |  (Yellow) | Locking in progress |
| |  (Gray) | Unable to lock or antenna failed |

CONSTELLATION

The Constellation is used to analyze transmitter modulation performance. The JD740A series displays the constellation diagram with modulation metrics to characterize the performance.

Measurement Procedure

| Step | Description |
|--|---|
| <p>1. Set the measurement mode MEASURE [Modulation Analysis] [Constellation]</p> | <p>Press the MEASURE hot key. Press the Modulation Analysis soft key. Press the Constellation soft key.</p> |
| <p>2. Set the measurement parameters MEASURE SETUP [PN Offset] <Auto> or <Manual></p> | <p>Press the MEASURE SETUP hot key. Press the PN Offset soft key. The Auto mode is set by default. Toggle between Auto and Manual.</p> |

| | |
|--|---|
| Enter a value [Enter] | Use the numeric keys to input value. Press the Enter soft key. |
| [PN Increment] Enter a value [Enter] | Press the PN Increment soft key. Use the numeric keys to input value. Press the Enter soft key. |

CDMA Constellation Measurement Procedure

MEASURE SETUP



- n **PN OFFSET:** Sets the PN Offset (Pseudo-Noise Offset) to **Auto** or **Manual**. Toggle between **Auto** and **Manual**. To change the value in the **Manual** mode, use the numeric keys and press the **Enter** soft key or the **ENTER** hard key to complete to the input.
- n **PN INCREMENT:** Sets the increment step for the PN Offset. Use the numeric keys to enter a value and press the **Enter** soft key or the **ENTER** hard key to complete to the input.

Setting Limit

LIMIT



This hot key is used to set the threshold value for the limit line on the display screen. It turns on or off the limit or band limit settings of the measurement for pass/fail indication. The user input window must be inactive first to get the Limit hot key function other than the number input.

| Step | Description |
|--|--|
| 1. Select the limit LIMIT [Modulation Test Limits] [Frequency Error] [Test Limits] <On> or <Off> [High Limit] [Low Limit] [Time Offset] [Test Limits] <On> or <Off> [High Limit] [Low Limit] | Press the LIMIT hot key. Press the Modulation Test Limits soft key. Press the Frequency Error soft key. Press the Test Limits soft key. Toggle between On and Off . Use the numeric keys and input a number in ppm. Use the numeric keys and input a number in ppm. Press the Time Offset soft key. Press the Test Limits soft key. Toggle between On and Off . Use the numeric keys and input a number in us. Use the numeric keys and input a number in us. |

| | |
|---|--|
| <p>[Rho] [Test Limit] <On> or <Off> [Low Limit]</p> <p>[Carrier Feed Through] [Test Limit] <On> or <Off> [High Limit]</p> | <p>Press the Rho soft key.</p> <p>Press the Test Limit soft key. Toggle between On and Off.</p> <p>Use the numeric keys and input a number.</p> <p>Press the Carrier Feed Through soft key.</p> <p>Press the Test Limit soft key. Toggle between On and Off.</p> <p>Use the numeric keys and input a number in dB.</p> |
| <p>2. Enable beep LIMIT [Beep] <On> or <Off></p> | <p>Press the LIMIT hot key.</p> <p>Press the Beep soft key to toggle between On and Off and select one. This will make audible alarm if the measurement result goes beyond the limit.</p> |

- n **FREQUENCY ERROR:** Sets the frequency error limit.
 - Y **TEST LIMITS:** Enables or disables the test limits. Toggle the **Test Limits** soft key between **On** and **Off**.
 - Y **HIGH LIMIT:** Sets the upper limit. Use the numeric keys to input value and press the unit soft key or the **ENTER** hard key to complete the input.
 - Y **LOW LIMIT:** Sets the lower limit. Use the numeric keys to input value and press the unit soft key or the **ENTER** hard key to complete the input.
- n **TIME OFFSET:** Sets the time offset limit. Time Offset compares the PN offset timing with the overall system time and the instrument checks the start of PN offset in comparison to either the GPS signal or the even second clock signal.
 - Y **TEST LIMITS:** Enables or disables the test limits. Toggle the **Test Limits** soft key between **On** and **Off**.
 - Y **HIGH LIMIT:** Sets the upper limit. Use the numeric keys to input value and press the unit soft key or the **ENTER** hard key to complete the input.
 - Y **LOW LIMIT:** Sets the lower limit. Use the numeric keys to input value and press the unit soft key or the **ENTER** hard key to complete the input.
- n **RHO:** Sets the waveform quality (Rho) limit. Rho measures the modulation quality for a CDMA transmitter along with EVM and Walsh Channel Power. It includes all errors occurred along the transmitter chain such as base band filtering, abnormality of I/Q modulator and distortion in power amplifier. A perfect Rho value is 1.0 indicating that all of the power is being transmitted correctly.
 - Y **TEST LIMIT:** Enables or disables the test limit. Toggle the **Test Limit** soft key between **On** and **Off**.

- Y **LOW LIMIT:** Sets the lower limit. Use the numeric keys to input value and press the unit soft key or the **ENTER** hard key to complete the input.
- n **CARRIER FEED THROUGH:** Sets the limit of carrier feed through. Carrier Feed Through is a result of the RF carrier signal feeding through the I/Q modulator and riding on the output circuitry without being modulated. It sets the limit of carrier feed through.
- Y **TEST LIMIT:** Enables or disables the test limit. Toggle the **Test Limit** soft key between **On** and **Off**.
- Y **HIGH LIMIT:** Sets the upper limit. Use the numeric keys to input value and press the unit soft key or the **ENTER** hard key to complete the input.
- n **PILOT POWER:** *This key is not used in the Constellation mode.*
- n **MAX INACTIVE:** *This key is not used in the Constellation mode.*

Measurement Example

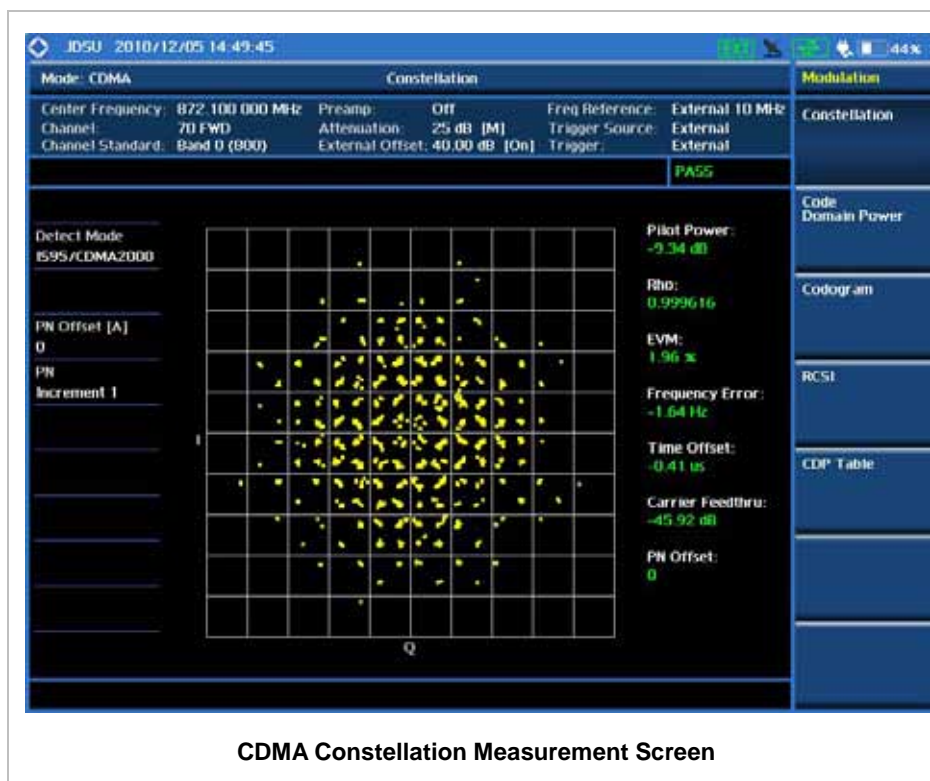

CODE DOMAIN POWER

The Code Domain Power (CDP) measurement provides code domain power analysis that measures

the distribution of power across the set of code channels, normalized to the total power. It helps to verify that each code channel is operating at its proper level and to identify problems throughout the transmitter design from coding to the RF section. System imperfections such as amplifier non-linearity will present themselves as an undesired distribution of power in the code domain.

Measurement Procedure

| Step | Description |
|--|--|
| 1. Set the measurement mode MEASURE [Modulation Analysis] [Code Domain Power] | Press the MEASURE hot key. Press the Modulation Analysis soft key. Press the Code Domain Power soft key. |
| 2. Set the measurement parameters MEASURE SETUP [PN Offset] <Auto> or <Manual> Enter a value [Enter] [PN Increment] Enter a value [Enter] [Threshold] Enter a value [dB] [Q-Paging] <On> or <Off> | Press the MEASURE SETUP hot key. Press the PN Offset soft key. The Auto mode is set by default. Toggle between Auto and Manual . Use the numeric keys to input value. Press the Enter soft key. Press the PN Increment soft key. Use the numeric keys to input value. Press the Enter soft key. Press the Threshold soft key. Use the numeric keys to input value. Press the unit soft key. Press the Q-Paging soft key. Toggle between On and Off . |

CDMA Code Domain Power Measurement Procedure

MEASURE SETUP



- n **PN OFFSET:** Sets the PN Offset (Pseudo-Noise Offset) to **Auto** or **Manual**. Toggle between **Auto** and **Manual**. To change the value in the **Manual** mode, use the numeric keys and press the **Enter** soft key or the **ENTER** hard key to complete to the input.
- n **PN INCREMENT:** Sets the increment step for the PN Offset. Use the numeric keys to enter a value and press the **Enter** soft key or the **ENTER** hard key to complete to the input.
- n **TRHESHOLD:** Sets the threshold value between Auto and Manual. Its default setting is -27 dB. To change the value in the **Manual** mode, use the numeric keys to enter a value between -50 and 0

and press the **Enter** soft key or the **ENTER** hard key to complete to the input.

- n **Q-PAGING:** Enable or disable the quick page channel that indicates the power of Quick Page Walsh code 80. Toggle between **On** and **Off**.

Setting Limit



This hot key is used to set the threshold value for the limit line on the display screen. It turns on or off the limit or band limit settings of the measurement for pass/fail indication. The user input window must be inactive first to get the Limit hot key function other than the number input.

| Step | Description |
|---|--|
| 1. Select the limit LIMIT [Modulation Test Limits] [Pilot Power] [Test Limits] <On> or <Off> [High Limit (Abs)] [Low Limit (Abs)] or [High Limit (Rel)] [Low Limit (Rel)] [Max Inactive] [Test Limit] <On> or <Off> [High Limit] | Press the LIMIT hot key. Press the Modulation Test Limits soft key. Press the Pilot Power soft key. Press the Test Limits soft key. Toggle between On and Off . Use the numeric keys and input a number in dB. Use the numeric keys and input a number in dB. Use the numeric keys and input a number in dB. Use the numeric keys and input a number in dB. Press the Max Inactive soft key. Press the Test Limit soft key. Toggle between On and Off . Use the numeric keys and input a number in dB. |
| 2. Enable beep LIMIT [Beep] <On> or <Off> | Press the LIMIT hot key. Press the Beep soft key to toggle between On and Off and select one. This will make audible alarm if the measurement result goes beyond the limit. |

- n **FREQUENCY ERROR:** *This key is not used in the Code Domain Power mode.*
- n **TIME OFFSET:** *This key is not used in the Code Domain Power mode.*
- n **RHO:** *This key is not used in the Code Domain Power mode.*
- n **CARRIER FEED THROUGH:** *This key is not used in the Code Domain Power mode.*

- n **PILOT POWER:** Sets the pilot power limit.
- Y **TEST LIMITS:** Enables or disables the test limits. Toggle the **Test Limits** soft key between **On** and **Off**.
- Y **HIGH LIMIT (ABS):** Sets the upper absolute limit. Use the numeric keys to input value and press the unit soft key or the **ENTER** hard key to complete the input.
- Y **LOW LIMIT (ABS):** Sets the lower absolute limit. Use the numeric keys to input value and press the unit soft key or the **ENTER** hard key to complete the input.
- Y **HIGH LIMIT (REL):** Sets the upper relative limit. Use the numeric keys to input value and press the unit soft key or the **ENTER** hard key to complete the input.
- Y **LOW LIMIT (REL):** Sets the lower relative limit. Use the numeric keys to input value and press the unit soft key or the **ENTER** hard key to complete the input.
- n **MAX INACTIVE:** Sets the limit of the highest level among inactive channels.
- Y **TEST LIMIT:** Enables or disables the test limit. Toggle the **Test Limit** soft key between **On** and **Off**.
- Y **HIGH LIMIT:** Sets the upper limit. Use the numeric keys to input value and press the unit soft key or the **ENTER** hard key to complete the input.

Setting Display

TRACE/DISPLAY



- n **CODE ORDER:** Selects the code order of the CDP display.
- Y **HADAMARD:** Assigns the number based on Walsh code order and displays the measured code power according to the assigned number in sequence.
- Y **BIT REVERSE:** Code number in binary bit is reversed relative to the Hadamard method.
- n **BASE CODE LENGTH:** Selects the base Walsh code length between **64** and **128**. Each time this soft key is pressed, the highlighted selection changes.

Measurement Example

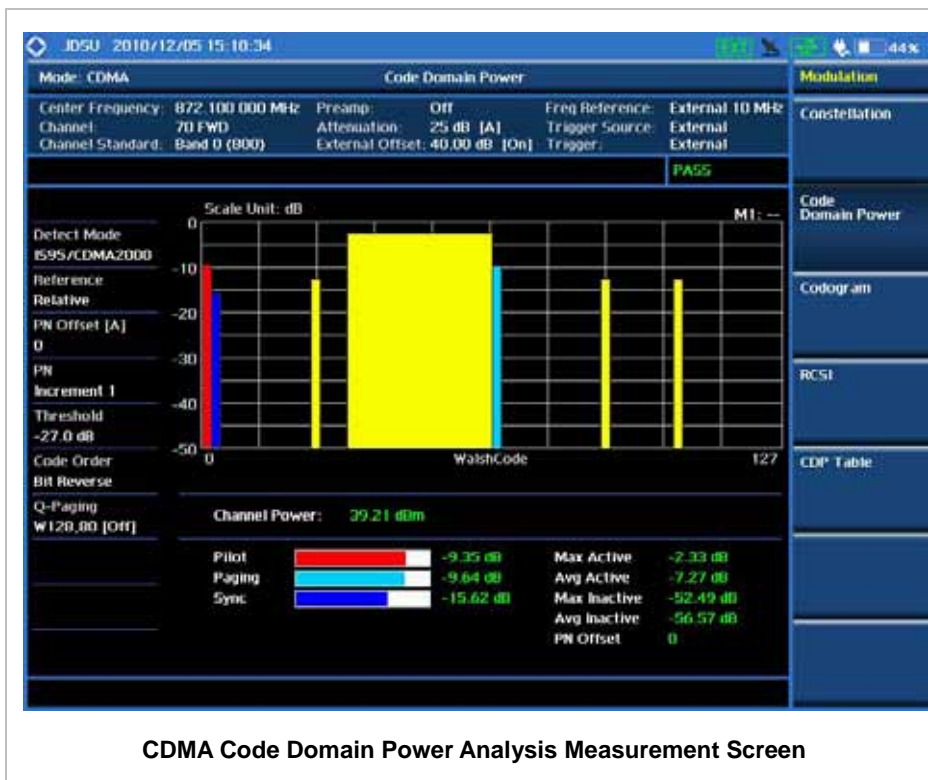

CODOGRAM

The Codogram shows how the code level is changing over time and makes it easier to see traffic channels as they initiate and terminate and to track traffic channels call levels over time. The Codogram measurements can be saved into an external USB memory so that a post-analysis can be done with the application software JDViewer.

Measurement Procedure

| Step | Description |
|---|--|
| 1. Set the measurement mode MEASURE [Modulation Analysis] [Codogram] | Press the MEASURE hot key. Press the Modulation Analysis soft key. Press the Codogram soft key. |
| 2. Set the measurement parameters MEASURE SETUP [PN Offset] <Auto> or <Manual> Enter a value | Press the MEASURE SETUP hot key. Press the PN Offset soft key. The Auto mode is set by default. Toggle between Auto and Manual . Use the numeric keys to input value. |

| | |
|--|--|
| [Enter] | Press the Enter soft key. |
| [PN Increment] Enter a value [Enter] | Press the PN Increment soft key. Use the numeric keys to input value. Press the Enter soft key. |
| [Threshold] Enter a value [dB] | Press the Threshold soft key. Use the numeric keys to input value. Press the unit soft key. |
| [Q-Paging] <On> or <Off> | Press the Q-Paging soft key. Toggle between On and Off . |
| [Time Interval] Enter a value [sec] | Press the Time Interval soft key. Use the numeric keys to input value. Press the unit soft key to complete the input. |
| [Auto Save] <On> or <Off> | Press the Auto Save soft key. Toggle between On and Off . |
| 3. Analyze the measurement result [Time Cursor] <On> or <Off> | Press the Time Cursor soft key. Toggle between On and Off . |

CDMA Codogram Measurement Procedure

MEASURE SETUP



- n **RESET/RESTART:** Restarts the measurement.
- n **AUTO SAVE:** Enables or disables automatic saving of the measurement data to an external USB memory. When it turns on, the measurements will be recorded into the default file (codogram.cod).
- n **TIME CURSOR:** Enables or disables the time cursor indicator. When the time cursor is enabled after specifying a number, measurement is put on hold and information of the specific number is updated on the measurement screen.
- n **TIME INTERVAL:** Sets the time interval. Use the numeric keys to enter a value and press the **Enter** soft key or the **ENTER** hard key to complete to the input. 0 is the fastest measurement speed. As the time interval gets larger, the measurement speed is reduced.
- n **PN OFFSET:** Sets the PN Offset (Pseudo-Noise Offset) to **Auto** or **Manual**. Toggle between **Auto** and **Manual**. To change the value in the **Manual** mode, use the numeric keys and press the **Enter** soft key or the **ENTER** hard key to complete to the input.
- n **PN INCREMENT:** Sets the increment step for the PN Offset. Use the numeric keys to enter a value and press the **Enter** soft key or the **ENTER** hard key to complete to the input.

- n **TRHESHOLD:** Sets the threshold value between **Auto** and **Manual**. Its default setting is -27 dB. To change the value in the **Manual** mode, use the numeric keys to enter a value between -50 and 0 and press the **Enter** soft key or the **ENTER** hard key to complete to the input.
- n **Q-PAGING:** Enable or disable the quick page channel that indicates the power of Quick Page Walsh code 80. Toggle between **On** and **Off**.

Setting Display

TRACE/DISPLAY

- n **CODE ORDER:** Selects the code order of the CDP display.
 - Y **HADAMARD:** Assigns the number based on Walsh code order and displays the measured code power according to the assigned number in sequence.
 - Y **BIT REVERSE:** Code number in binary bit is reversed relative to the Hadamard method.
- n **BASE CODE LENGTH:** Selects the base Walsh code length between **64** and **128**. Each time this soft key is pressed, the highlighted selection changes.

Measurement Example

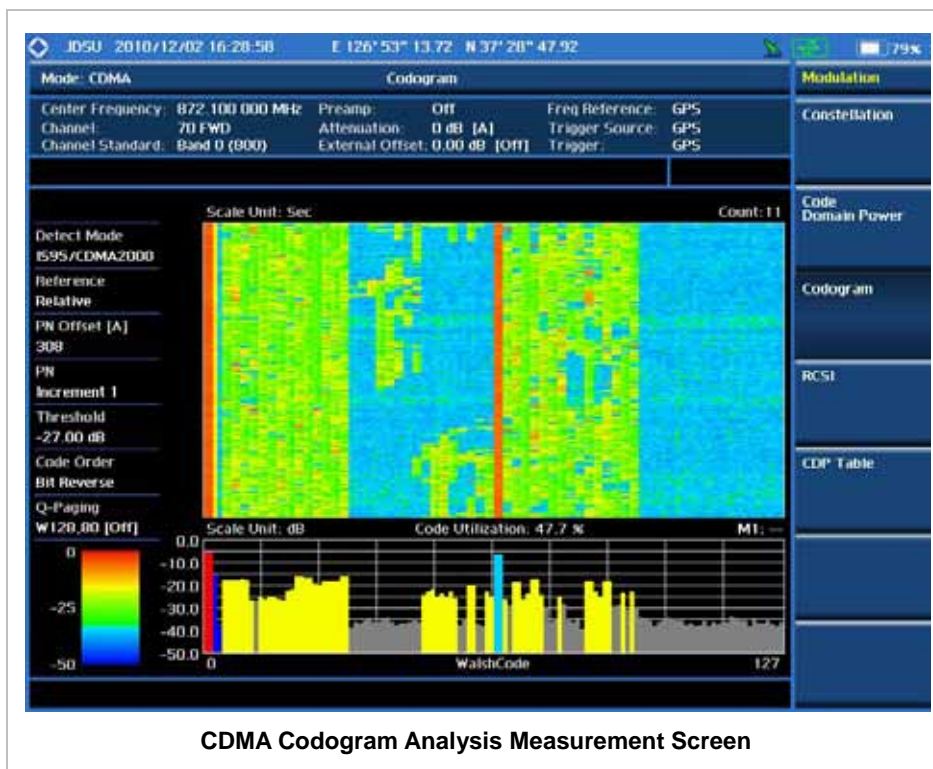

The screen can display maximum 260 measurements at a time. When they become more than 260,

new measurements are updated from the bottom of the display and old measurements disappear on the top of the display.

RCSI

The Received Code Strength Indicator (RCSI) is used to track the power variation of cdmaOne or CDMA2000 control channels such as Pilot, Paging, Sync, and Q-Paging over time. The RCSI measurements can be saved into an external USB memory so that a post-analysis can be done with the application software JDViewer.

Measurement Procedure

| Step | Description |
|--|---|
| 1. Set the measurement mode MEASURE [Modulation Analysis] [RCSI] | Press the MEASURE hot key. Press the Modulation Analysis soft key. Press the RCSI soft key. |
| 2. Set the measurement parameters MEASURE SETUP [PN Offset] <Auto> or <Manual> Enter a value [Enter] [PN Increment] Enter a value [Enter] [Threshold] Enter a value [dB] [Q-Paging] <On> or <Off> [Alarm Code] [None], [Pilot], [Page], [Sync], or [Q-Paging] | Press the MEASURE SETUP hot key. Press the PN Offset soft key. The Auto mode is set by default. Toggle between Auto and Manual . Use the numeric keys to input value. Press the Enter soft key. Press the PN Increment soft key. Use the numeric keys to input value. Press the Enter soft key. Press the Threshold soft key. Use the numeric keys to input value. Press the unit soft key. Press the Q-Paging soft key. Toggle between On and Off . Press the Alarm Code soft key. Press one of the alarm code soft keys to select. |

| | |
|--|---|
| <p>[Set Mask] Enter a value [dB] or [dBm]</p> | <p>Press the Set Mask soft key. Use the numeric keys to input value. Press the unit soft key. The unit changes according to the reference setting (relative or absolute) in Amp/Scale.</p> |
| <p>[Auto Save] <On> or <Off></p> | <p>Press the Auto Save soft key. Toggle between On and Off.</p> |

CDMA RCSI Measurement Procedure

MEASURE SETUP 

- n **RESET/RESTART:** Restarts the measurement.
- n **AUTO SAVE:** Enables or disables automatic saving of the measurement data to an external USB memory. When it turns on, the measurements will be recorded into the default file (rcsi.rcs).
- n **ALARM CODE:** Selects the alarm code among **None**, **Pilot**, **Page**, **Sync**, and **Q-Paging**.
- n **SET MASK:** Sets the alarm mask value in dB for relative mode or dBm in absolute mode. The unit changes to dB or dBm according to the reference setting (relative or absolute) in the Amp/Scale menu. Use the numeric keys to enter a value and press the unit soft key or the **ENTER** hard key to complete to the input.
- n **PN OFFSET:** Sets the PN Offset (Pseudo-Noise Offset) to **Auto** or **Manual**. Toggle between **Auto** and **Manual**. To change the value in the **Manual** mode, use the numeric keys and press the **Enter** soft key or the **ENTER** hard key to complete to the input.
- n **PN INCREMENT:** Sets the increment step for the PN Offset. Use the numeric keys to enter a value and press the **Enter** soft key or the **ENTER** hard key to complete to the input.
- n **TRHESHOLD:** Sets the threshold value between **Auto** and **Manual**. Its default setting is -27 dB. To change the value in the **Manual** mode, use the numeric keys to enter a value between -50 and 0 and press the **Enter** soft key or the **ENTER** hard key to complete to the input.
- n **Q-PAGING:** Enable or disable the quick page channel that indicates the power of Quick Page Walsh code 80. Toggle between **On** and **Off**.

Setting Display

TRACE/DISPLAY 

- n **CODE ORDER:** Selects the code order of the CDP display.
- Y **HADAMARD:** Assigns the number based on Walsh code order and displays the measured

code power according to the assigned number in sequence.

- Y **BIT REVERSE:** Code number in binary bit is reversed relative to the Hadamard method.
- n **BASE CODE LENGTH:** Selects the base Walsh code length between **64** and **128**. Each time this soft key is pressed, the highlighted selection changes.

Measurement Example



CDMA RCSI Analysis Measurement Screen

CDP TABLE

The CDP Table is used for the user to look at a numeric and textual description of all the active control channels in the signal.

Measurement Procedure

| Step | Description |
|---|-----------------------------------|
| 1. Set the measurement mode MEASURE | Press the MEASURE hot key. |

| | |
|---|--|
| <p>[Modulation Analysis] [CDP Table]</p> | <p>Press the Modulation Analysis soft key. Press the CDP Table soft key.</p> |
| <p>2. Set the measurement parameters MEASURE SETUP [PN Offset] <Auto> or <Manual> Enter a value [Enter]</p> <p>[PN Increment] Enter a value [Enter]</p> <p>[Threshold] Enter a value [dB]</p> <p>[Q-Paging] <On> or <Off></p> | <p>Press the MEASURE SETUP hot key. Press the PN Offset soft key. The Auto mode is set by default. Toggle between Auto and Manual. Use the numeric keys to input value. Press the Enter soft key.</p> <p>Press the PN Increment soft key. Use the numeric keys to input value. Press the Enter soft key.</p> <p>Press the Threshold soft key. Use the numeric keys to input value. Press the unit soft key.</p> <p>Press the Q-Paging soft key. Toggle between On and Off.</p> |

CDMA CDP Table Measurement Procedure

MEASURE SETUP



- n **PN OFFSET:** Sets the PN Offset (Pseudo-Noise Offset) to **Auto** or **Manual**. Toggle between **Auto** and **Manual**. To change the value in the **Manual** mode, use the numeric keys and press the **Enter** soft key or the **ENTER** hard key to complete to the input.
- n **PN INCREMENT:** Sets the increment step for the PN Offset. Use the numeric keys to enter a value and press the **Enter** soft key or the **ENTER** hard key to complete to the input.
- n **TRHESHOLD:** Sets the threshold value between Auto and Manual. Its default setting is -27 dB. To change the value in the **Manual** mode, use the numeric keys to enter a value between -50 and 0 and press the **Enter** soft key or the **ENTER** hard key to complete to the input.
- n **Q-PAGING:** Enable or disable the quick page channel that indicates the power of Quick Page Walsh code 80. Toggle between **On** and **Off**.

Setting Display

TRACE/DISPLAY



- n **CODE ORDER:** Selects the code order.

- Y **HADAMARD:** Assigns the number based on Walsh code order and displays the measured code power according to the assigned number in sequence.
- Y **BIT REVERSE:** Code number in binary bit is reversed relative to the Hadamard method.
- n **BASE CODE LENGTH:** Selects the base Walsh code length between **64** and **128**. Each time this soft key is pressed, the highlighted selection changes.
- n **PAGE UP:** Scrolls up the page to the previous screen.
- n **PAGE DOWN:** Scrolls down the page to the next screen.

Measurement Example

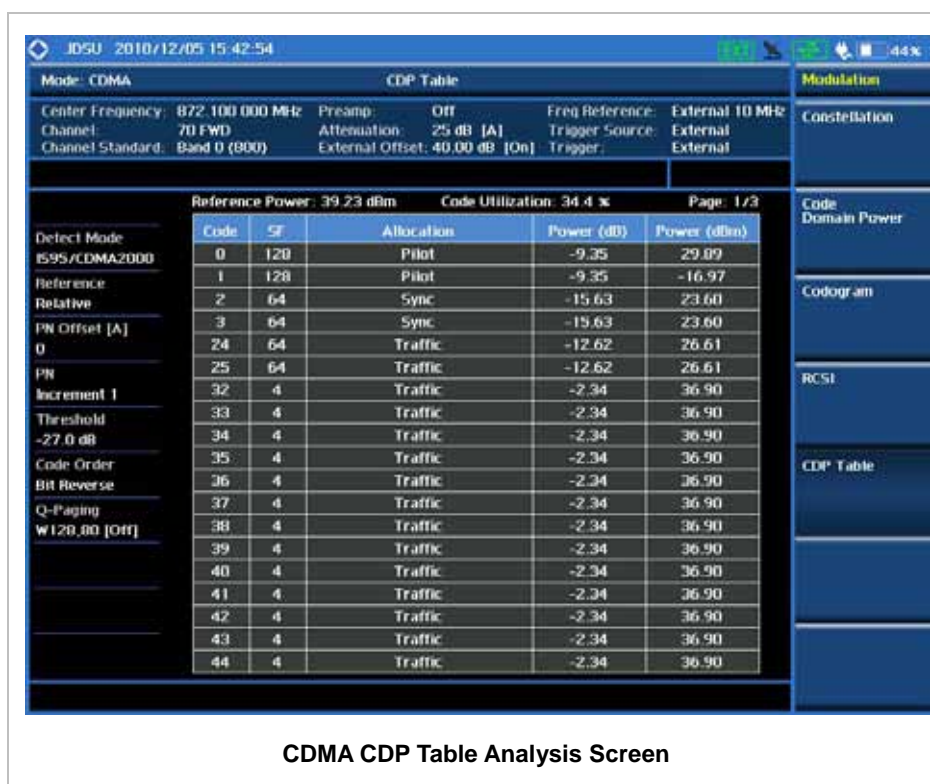

CDMA CDP Table Analysis Screen

AUTO MEASUREMENT

The Auto Measure function of the JD740A series allows a complete signal profiling covering RF characterization and modulation quality parameters of up to 10 different carriers, particularly useful on an overlay architecture where base stations are transmitting in different frequencies.

The Auto Measure can be easily executed either by selecting a menu in the instrument or by running a programmed scenario in the PC-based application so that the instrument automatically configure and

perform tests on every aspect of all the carriers.

Setting Mode

| Step | Description |
|---|---|
| 1. Connect the cable | Connect a cable directly or indirectly as shown in the section Connecting a Cable on page 7 of this chapter. |
| 2. Select the mode MODE [Signal Analyzer] [CDMA] [Auto Measure] | Press the MODE hard key. Press the Signal Analyzer soft key. Press the CDMA soft key. Press the Auto Measure soft key. |

Following settings are required only when you run Auto Measure on the instrument using “Current” configuration setting. Additional settings are not required when you run Auto Measure using a scenario generated in the PC application software, JDViewer.

Setting Frequency

| Step | Description |
|--|---|
| 1. Set the frequency FREQ/DIST [Unit] <Freq> or <Channel> <i>When Freq is selected:</i> [Center Frequency] Enter a value [GHz], [MHz], [kHz], or [Hz] <i>When Channel is selected:</i> [Channel Standard] Select a channel standard [Select] or ENTER [Channel Number] | Press the FREQ/DIST hard key. Press the Unit soft key. Toggle this key between Freq and Channel . A set of Freq/Dist screen menu changes accordingly. Press the Center Frequency soft key. Use the numeric keys, the rotary knob, or the arrow keys. When using the numeric keys, the input is completed by selecting one of the unit soft keys. Press the Channel Standard soft key. Press the arrow keys, rotate the knob, or press the Page Up and Page Down soft keys to highlight a frequency band to select. Press the Select soft key or the ENTER hard key. Press the Channel Number soft key. |

| | |
|-----------------------------------|---|
| Enter a value [Forward] | Use the numeric keys to input value and press the Forward soft key to complete the input. The instrument automatically displays its corresponding center frequency value for the channel number. |
|-----------------------------------|---|

FREQ/DIST



- n **UNIT:** Determines the way how to set the frequency band either with standard band or custom frequency band. Toggling this key between **Freq** and **Channel** changes a set of Freq/Dist screen menu automatically.
- n **CENTER FREQUENCY:** Changes the center frequency setting. Use the rotary knob or the arrow keys. Or use the numeric keys to input a certain value and press one of the unit soft keys to complete the input.
- n **FREQUENCY STEP:** Defines the amount of frequency to be increased or decreased when using the rotary knob or the arrow keys to change the **Center Frequency**. This frequency step size can be entered by using numeric keys and the unit soft keys.
- n **CHANNEL NUMBER:** Enters a channel number. The instrument automatically displays its corresponding center frequency value for the channel number.
- n **CHANNEL STEP:** Defines the amount of channel to be increased or decreased when using the rotary knob or the arrow keys to change the **Channel Number**. This channel step size can be entered by using numeric keys and the **Enter** soft key.
- n **CHANNEL STANDARD:** When the channel standard is selected from the list, the center frequency information on the display screen will be mapped accordingly to the selected channel standard. The channel standards available in the instrument are listed in the Appendix C – Band, Frequency & Channel Standard.

Setting Trigger Source

TRIGGER



This hot key is used to select the trigger source among **Internal**, **External**, and **GPS**. The user input window must be inactive first to get the Trigger hot key function other than the number input.

Setting External Clock

To enhance the reliability of modulation analysis measurements the JD740A series must be synchronized with the Base Station. When an external clock is not supplied, the JD740A series works

with a built-in internal high-accuracy time base. In this case, some measurement results may exhibit inaccurate values. Therefore, it is highly recommended to use the same reference clock as signal source. Trigger mode can be changed by using the **TRIGGER** hot key.

EXTERNAL CLOCK OPERATING STANDARDS

| Clock | Type | Reference | Port | Switching Standard |
|--------------------|----------|--------------------|---------------|--|
| External Reference | Internal | Internal 10 MHz | | Default |
| | External | External Ref Clock | Ext Ref (SMA) | Manual switching (Input signal level >-3 dBm) |
| | GPS | GPS Clock | GPS (SMA) | Automatic switching (GPS signal received) |
| Trigger | Internal | Internal Trigger | | Default |
| | External | External Trigger | Trigger (SMA) | Manual switching |
| | GPS | GPS | GPS (SMA) | Manual switching |

CONNECTION

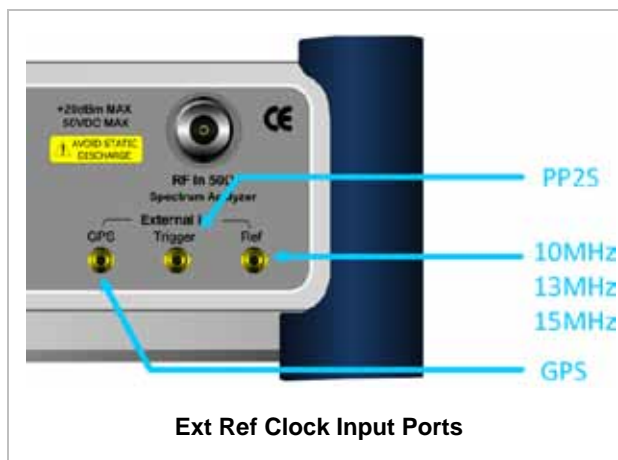

ENABLING EXTERNAL REFERENCE

| Step | Description |
|--|--|
| 1. Connect an external reference | Connect one of the external references or a GPS antenna to the JD740A series. |
| 2. Change reference clock SYSTEM [Frequency Reference] | Press the SYSTEM hot key. Press the Frequency Reference soft key to select one of the external reference clocks or GPS. |

| | |
|---|---|
| <p>[External 10 MHz], [External 13 MHz], [External 15 MHz] or [GPS]</p> | <p>Press one of the soft keys to choose among External 10 MHz, External 13 MHz, External 15 MHz, and GPS.</p> |
|---|---|

EXTERNAL REFERENCE INDICATOR INFORMATION

Each indicator tells different locking status according to a connection. When a GPS antenna is connected, longitude and latitude information will be displayed on the screen.

| Type | Indicator | Description |
|----------|--|----------------------------------|
| Internal |  (Green) | Locked |
| External |  (Green) | Locked |
| |  (Red) | Unlocked |
| GPS |  (Green) | Locked |
| |  (Yellow) | Locking in progress |
| |  (Gray) | Unable to lock or antenna failed |

Setting Limit



This hot key is used to set the threshold value for the limit line on the display screen. It turns on or off the limit or band limit settings of the measurement for pass/fail indication. The user input window must be inactive first to get the Limit hot key function other than the number input.

| Step | Description |
|--|---|
| <p>1. Set the RF test limit LIMIT [RF Test Limits] [Channel Power] [Test Limits] <On> or <Off> [High Limit] Enter a value [dBm] or ENTER [Low Limit] Enter a value [dBm] or ENTER</p> | <p>Press the LIMIT hot key. Press the RF Test Limits soft key. Press the Channel Power soft key. Press the Test Limits soft key to toggle between On and Off and select one. Press the High Limit soft key to set the upper limit of the Pass/Fail criteria. Use the numeric keys to input value. Press the unit soft key or the ENTER hard key. Press the Low Limit soft key to set the lower limit of the Pass/Fail criteria. Use the numeric keys to input value. Press the unit soft key or the ENTER hard key.</p> |

| | |
|---|---|
| <p>[Occupied BW] [Test Limit] <On> or <Off> [High Limit] Enter a value [MHz], [kHz], or [Hz]</p> <p>[Spectrum Emission Mask] [Test Limit] <On> or <Off></p> <p>[ACPR] [Test Limit] <On> or <Off></p> <p>[Multi-ACPR] [Test Limit] <On> or <Off></p> <p>[Spurious Emissions] [Test Limit] <On> or <Off></p> | <p>Press the Occupied BW soft key. Press the Test Limit soft key to toggle between On and Off and select one. Press the High Limit soft key to set the upper limit of the Pass/Fail criteria. Use the numeric keys to input value. Press the unit soft key to select.</p> <p>Press the Spectrum Emission Mask soft key. Press the Test Limit soft key to toggle between On and Off and select one.</p> <p>Press the ACPR soft key. Press the Test Limit soft key to toggle between On and Off and select one.</p> <p>Press the Multi-ACPR soft key. Press the Test Limit soft key to toggle between On and Off and select one.</p> <p>Press the Spurious Emissions soft key. Press the Test Limit soft key to toggle between On and Off and select one.</p> |
| <p>2. Enable beep LIMIT [Beep] <On> or <Off></p> | <p>Press the LIMIT hot key. Press the Beep soft key to toggle between On and Off and select one. This will make audible alarm if the measurement result goes beyond the limit.</p> |

n **CHANNEL POWER:** Sets the test limit parameters.

Y **TEST LIMITS:** Enables or disables Pass/Fail results on the display screen. Toggle the **Test Limits** soft key to set it to **On** or **Off**.

Y **HIGH LIMIT:** Sets the upper limit of the Pass/Fail criteria. Use the numeric keys to enter a threshold or limit value and press the **dBm** unit soft key or the **ENTER** hard key to complete the input.

Y **LOW LIMIT:** Sets the lower limit of the Pass/Fail criteria. Use the numeric keys to enter a threshold or limit value and press the **dBm** unit soft key or the **ENTER** hard key to complete the input.

n **OCCUPIED BW:** Sets the test limit parameters.

Y **TEST LIMIT:** Enables or disables Pass/Fail results on the display screen. Toggle the **Test Limit** soft key to set it to **On** or **Off**.

- Y **HIGH LIMIT:** Sets the upper limit of the Pass/Fail criteria. Use the numeric keys to enter a threshold or limit value and press one of the unit soft keys to complete the input.
- n **SPECTRUM EMISSION MASK:** Sets the test limit parameter.
 - Y **TEST LIMIT:** Enables or disables Pass/Fail results on the display screen. Toggle the **Test Limit** soft key to set it to **On** or **Off**.
- n **ACPR:** Sets the test limit parameter.
 - Y **TEST LIMIT:** Enables or disables Pass/Fail results on the display screen. Toggle the **Test Limit** soft key to set it to **On** or **Off**.
- n **MULTI-ACPR:** Sets the test limit parameter.
 - Y **TEST LIMIT:** Enables or disables Pass/Fail results on the display screen. Toggle the **Test Limit** soft key to set it to **On** or **Off**.
- n **SPURIOUS EMISSIONS:** Sets the test limit parameter.
 - Y **TEST LIMIT:** Enables or disables Pass/Fail results on the display screen. Toggle the **Test Limit** soft key to set it to **On** or **Off**.

Measurement Procedure

| Step | Description |
|---|---|
| 1. Select the mode MEASURE [Auto Measure] | Press the MEASURE hot key. Press the Auto Measure soft key. |
| 2. Set the measurement parameters MEASURE SETUP [Configuration] <Current> or <Scenario> [Load Scenario] [Test Time] <Now> or <Schedule> [Set Timing] [Start Time (HH:MM)] Enter a value [HHMM] | Press the MEASURE SETUP hot key. Press the Configuration soft key to select the mode. Toggle this soft key between Current and Scenario . Press the Load Scenario soft key to load a scenario file. This key is active only when the Configuration is set to Scenario . Press the Test Time soft key to select when to run a test. Toggle this soft key between Now and Schedule . Press the Set Timing soft key. This key is activated only when the Test Time is set to Schedule. Press the Start Time soft key. Use the numeric keys to input value in HH:MM format. Press the HHMM soft key to complete the input. |

| | |
|--|--|
| <p>[Stop Time (HH:MM)]</p> | <p>Press the Stop Time soft key.</p> |
| <p>Enter a value</p> | <p>Use the numeric keys to input value in HH:MM format.</p> |
| <p>[HHMM]</p> | <p>Press the HHMM soft key to complete the input.</p> |
| <p>[Time Interval]</p> | <p>Press the Time Interval soft key.</p> |
| <p>Enter a value</p> | <p>Use the numeric keys to input value in minutes.</p> |
| <p>[Min]</p> | <p>Press the Min soft key to complete the input.</p> |
| <p>[Save Result]</p> | <p>Press the Save Result soft key.</p> |
| <p>[File Name]</p> | <p>Press the File Name soft key to assign a specific name to the test result.</p> |
| <p>[Save to]</p> | <p>Press the Save to soft key to select where to save the test result. Toggle this soft key between Internal and USB.</p> |
| <p><Internal> or <USB></p> | <p>Press the Save Screen soft key to choose the save option.</p> |
| <p>[Save Screen]</p> | <p>Toggle this soft key between All and Fail. This key is activated only when the Save to is set to USB.</p> |
| <p><All> or <Fail></p> | <p>Press the Run Test soft key to run a test.</p> |
| <p>[Run Test]</p> | <p></p> |

CDMA Auto Measurement Procedure

MEASURE SETUP



- n **RUN TEST:** Starts a test.
- n **CONFIGURATION:** Selects the measurement configuration to be used. When the **Current** is selected, the instrument runs a test using current carrier frequency (single carrier) and determines pass/fail based on the instrument's limit settings. Select the **Scenario** to run a test with a programmed scenario.
- n **LOAD SCENARIO:** Selects and loads a scenario file generated by the PC application software, JDViewer. This soft key is activated only when the **Configuration** is set to **Scenario**.
- n **TEST TIME:** Selects the test time. When **Now** is selected, the instrument runs a test only once. When **Schedule** is selected, the instrument repeats tests as defined in the **Set Timing** menu.
- n **SET TIMING:** Sets the **Start Time**, **Stop Time**, and **Time Interval** of a scheduled measurement. This soft key is activated only when the **Test Time** is set to **Schedule**.
- n **SAVE RESULT:** Sets parameters for saving measurement results. The instrument automatically saves measurement results in *.CSV format as well so that they can be imported in an application software that supports the CSV format.
- Y **FILE NAME:** Sets the measurement result file name.
- Y **SAVE TO:** Sets the destination where the result to be saved, **Internal** or **USB**.
- Y **SAVE SCREEN:** Selects what results to be saved into a USB drive. Toggle this soft key between **All**

for all the measurement items and **Fail** for failed items only. This key is activated only when the **Save to** is set to **USB**.

- n **EXTERNAL OFFSET:** Sets an external offset value. An offset consists of a cable loss and a user offset and the measurement result shows the value reflecting both offset values. When the external offset value is set at 40 dB in the Spectrum mode, the measurement result compensates 40 dB at both the Spectrum Analyzer and Signal Analyzer modes.

Setting Display

TRACE/DISPLAY

- n **DISPLAY:** Changes the display option. After running automatic measurement, toggle this key between **Results** and **Settings**.
 - Y **RESULTS:** Shows actual measurement results on the display screen.
 - Y **SETTINGS:** Shows measurement parameters set for the automatic measurement.
- n **DISPLAY RESULTS:** Changes the display format of measurement results. This key becomes activated when the **Results** is set as the display option. Toggle this key between **Full** and **Quick** to check measurement results in different format.
 - Y **FULL:** Shows detailed measurement results, including actual measurement readings with pass/fail color indication.
 - Y **QUICK:** Shows quick view of pass/fail results.
- n **VIEW CARRIER:** Selects a carrier to be displayed among up to 10 carriers. This key becomes activated when the **Results** is set as the display option.

POWER STATISTICS CCDF

Power Statistics Complementary Cumulative Distribution Function (CCDF) measurement characterizes the power statistics of input signal. It provides PAR (Peak to Average power Ratio) versus different probabilities.

Setting Mode

| Step | Description |
|----------------------|--|
| 1. Connect the cable | Connect a cable directly or indirectly as shown in the |

| | |
|---|--|
| | section Connecting a Cable on page 7 of this chapter. |
| 2. Select the mode MODE [Signal Analyzer] [CDMA] [Power Statistics CCDF] | Press the MODE hard key. Press the Signal Analyzer soft key. Press the CDMA soft key. Press the Power Statistics CCDF soft key. |

Setting Frequency

| Step | Description |
|--|---|
| 1. Set the frequency FREQ/DIST [Unit] <Freq> or <Channel> | Press the FREQ/DIST hard key. Press the Unit soft key. Toggle this key between Freq and Channel . A set of Freq/Dist screen menu changes accordingly. |
| <u>When Freq is selected:</u> [Center Frequency] Enter a value [GHz], [MHz], [kHz], or [Hz] | Press the Center Frequency soft key. Use the numeric keys, the rotary knob, or the arrow keys. When using the numeric keys, the input is completed by selecting one of the unit soft keys. |
| <u>When Channel is selected:</u> [Channel Standard] Select a channel standard [Select] or ENTER | Press the Channel Standard soft key. Press the arrow keys, rotate the knob, or press the Page Up and Page Down soft keys to highlight a frequency band to select. Press the Select soft key or the ENTER hard key. |
| [Channel Number] Enter a value [Forward] | Press the Channel Number soft key. Use the numeric keys to input value and press the Forward soft key to complete the input. The instrument automatically displays its corresponding center frequency value for the channel number. |

FREQ/DIST



- n **UNIT:** Determines the way how to set the frequency band either with standard band or custom frequency band. Toggling this key between **Freq** and **Channel** changes a set of Freq/Dist screen menu automatically.

- n **CENTER FREQUENCY:** Changes the center frequency setting. Use the rotary knob or the arrow keys. Or use the numeric keys to input a certain value and press one of the unit soft keys to complete the input.
- n **FREQUENCY STEP:** Defines the amount of frequency to be increased or decreased when using the rotary knob or the arrow keys to change the **Center Frequency**. This frequency step size can be entered by using numeric keys and the unit soft keys.
- n **CHANNEL NUMBER:** Enters a channel number. The instrument automatically displays its corresponding center frequency value for the channel number.
- n **CHANNEL STEP:** Defines the amount of channel to be increased or decreased when using the rotary knob or the arrow keys to change the **Channel Number**. This channel step size can be entered by using numeric keys and the **Enter** soft key.
- n **CHANNEL STANDARD:** When the channel standard is selected from the list, the center frequency information on the display screen will be mapped accordingly to the selected channel standard. The channel standards available in the instrument are listed in the Appendix C – Band, Frequency & Channel Standard.

Setting Amplitude

| Step | Description |
|--|---|
| 1. Set the reference/attenuation level AMP/SCALE [Auto Scale] or [Attenuation] <Manual> Enter an attenuation value | Press the AMP/SCALE hard key. Press the Auto Scale soft key to automatically set optimum levels of reference and attenuation. Press the Attenuation soft key. The Auto mode is set by default. This key toggles between the Auto and Manual . Press the Attenuation soft key to highlight the Manual mode and change the attenuation value to optimize S/N. Use the numeric keys or the rotary knob that changes in a 5 dB step. The attenuation setting range is 0 to 50 dB. |

AMP/SCALE

- n **AUTO SCALE:** The instrument can automatically set the scale to the minimum and maximum values on the Y-axis of the graph for optimum display of the traces measured. Each time the **Auto Scale** is selected, the top and bottom scales are set to the minimum and maximum values with margin on the Y-axis of the display screen.

n **ATTENUATION**

- Y **AUTO:** Input attenuator's value is automatically set depending on the reference level. This is the default operation mode, so it is recommended to use this mode unless a special measurement condition is needed.
- Y **MANUAL:** Sets the attenuator's value for the **Spectrum Analyzer RF In 50 Ω** port.

Setting Sweep Mode



This hot key is used to set the sweep parameters. The user input window must be inactive first to get the Sweep hot key function other than the number input.

- n **SWEEP MODE:** Sets the sweep method. Toggle between **Continue** and **Single**.

| Step | Description |
|--|---|
| 1. Set the sweep mode SWEEP [Sweep Mode] | Press the SWEEP hot key. Press the Sweep Mode soft key. Toggle between Continue and Single . |

Setting Trigger Source



This hot key is used to select the trigger source among **Internal**, **External**, and **GPS**. The user input window must be inactive first to get the Trigger hot key function other than the number input.

Setting External Clock

To enhance the reliability of modulation analysis measurements the JD740A series must be synchronized with the Base Station. When an external clock is not supplied, the JD740A series works with a built-in internal high-accuracy time base. In this case, some measurement results may exhibit inaccurate values. Therefore, it is highly recommended to use the same reference clock as signal source. Trigger mode can be changed by using the **TRIGGER** hot key.

EXTERNAL CLOCK OPERATING STANDARDS

| Clock | Type | Reference | Port | Switching Standard |
|--------------------|----------|--------------------|---------------|--|
| External Reference | Internal | Internal 10 MHz | | Default |
| | External | External Ref Clock | Ext Ref (SMA) | Manual switching (Input signal level >-3 dBm) |
| | GPS | GPS Clock | GPS (SMA) | Automatic switching (GPS signal received) |
| Trigger | Internal | Internal Trigger | | Default |
| | External | External Trigger | Trigger (SMA) | Manual switching |
| | GPS | GPS | GPS (SMA) | Manual switching |

CONNECTION

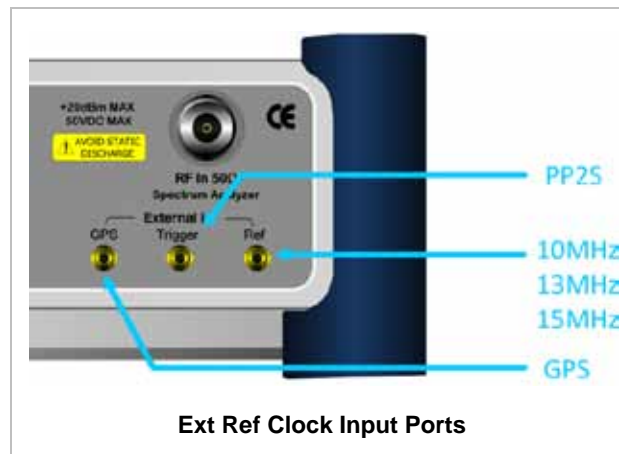

ENABLING EXTERNAL REFERENCE

| Step | Description |
|--|--|
| 1. Connect an external reference | Connect one of the external references or a GPS antenna to the JD740A series. |
| 2. Change reference clock SYSTEM [Frequency Reference] [External 10 MHz], [External 13 MHz], [External 15 MHz] or [GPS] | Press the SYSTEM hot key. Press the Frequency Reference soft key to select one of the external reference clocks or GPS. Press one of the soft keys to choose among External 10 MHz , External 13 MHz , External 15 MHz , and GPS . |

EXTERNAL REFERENCE INDICATOR INFORMATION

Each indicator tells different locking status according to a connection. When a GPS antenna is connected, longitude and latitude information will be displayed on the screen.

| Type | Indicator | Description |
|----------|--|----------------------------------|
| Internal |  (Green) | Locked |
| External |  (Green) | Locked |
| |  (Red) | Unlocked |
| GPS |  (Green) | Locked |
| |  (Yellow) | Locking in progress |
| |  (Gray) | Unable to lock or antenna failed |

Measurement Procedure

| Step | Description |
|--|---|
| 1. Set the measurement parameters MEASURE SETUP [CCDF Length] Enter a value [Enter] | Press the MEASURE SETUP hot key. Press the CCDF Length soft key. Use the numeric keys to input value. Press the Enter soft key. |

CDMA Power Statistics CCDF Measurement Procedure

MEASURE SETUP



- n **CCDF LENGTH:** Sets the length of the CCDF which is the number of measurements to be averaged. To change the value, use the numeric keys and press the **Enter** soft key or the **ENTER** hard key to complete to the input (value range 1 to 100).

Measurement Example

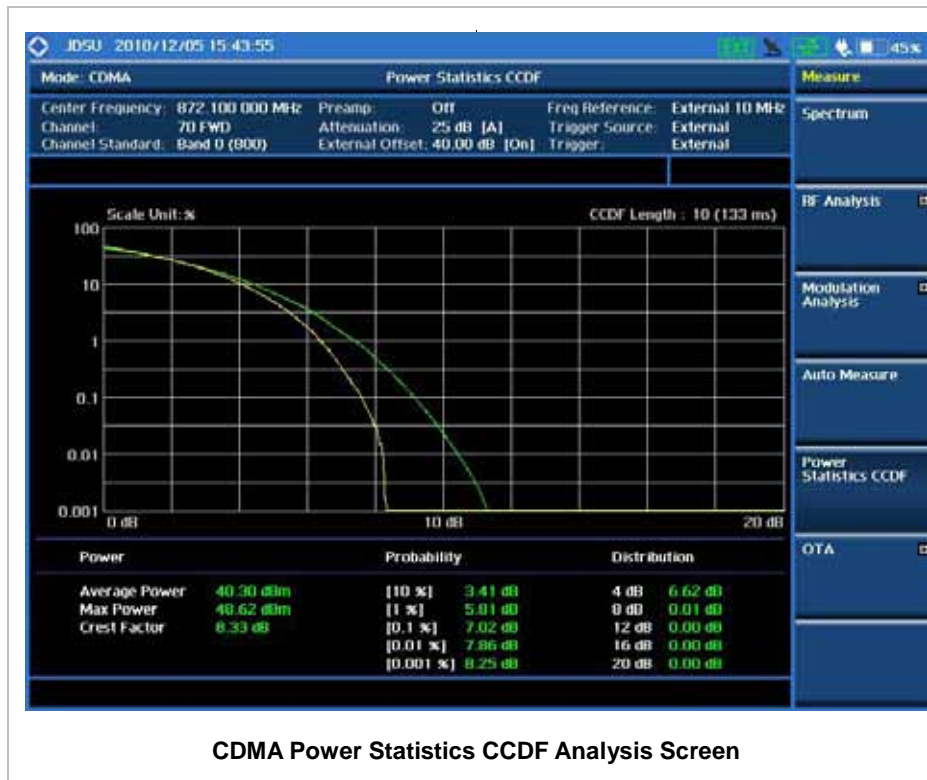

CDMA OTA MEASUREMENTS

This Over The Air (OTA) measurement has channel scanner, PN scanner, multipath profile, and Code Domain power screens. It is used to verify CDMA transmitter performance at any location providing reflective measurements and identifying signals providing from different sites. The Code Domain power shows not only modulation performance metric but also amplifier capacity and code utilization metric. The Amplifier capacity (code utilization) measurement is an estimate of the amount of power amplifier capacity (code utilization) that is being used expressed in percent of maximum.

CDMA OTA Measurements provide the following essential measurements.

- n Channel Scanner
- n PN Scanner
- n Multipath Profile
- n Code Domain Power
- n Route Map

Setting Mode

Connecting a GPS antenna with the instrument is mandatory for the OTA measurements.

| Step | Description |
|--|--|
| 1. Connect the antenna | Connect antennas as shown in the Connecting a Cable on page 8 of this chapter. |
| 2. Select the mode MODE [Signal Analyzer] [CDMA] [OTA] [Channel Scanner], [PN Scanner], [Multipath Profile], [Code Domain Power], or [Route Map] | Press the MODE hard key. Press the Signal Analyzer soft key. Press the CDMA soft key. Press the OTA soft key. Press one of the measurement mode soft keys to select. |

Setting Frequency

Setting frequency described here is not applicable to the OTA Channel Scanner mode. For the OTA Channel Scanner mode, refer to its measurement procedure.

| Step | Description |
|---|--|
| 1. Set the frequency FREQ/DIST [Unit] <Freq> or <Channel> <i>When Freq is selected:</i> [Center Frequency] Enter a value [GHz], [MHz], [kHz], or [Hz] <i>When Channel is selected:</i> [Channel Standard] Select a channel standard [Select] or ENTER | Press the FREQ/DIST hard key. Press the Unit soft key. Toggle this key between Freq and Channel . A set of Freq/Dist screen menu changes accordingly. Press the Center Frequency soft key. Use the numeric keys, the rotary knob, or the arrow keys. When using the numeric keys, the input is completed by selecting one of the unit soft keys. Press the Channel Standard soft key. Press the arrow keys, rotate the knob, or press the Page Up and Page Down soft keys to highlight a frequency band to select. Press the Select soft key or the ENTER hard key. |

| | |
|---|--|
| <p>[Channel Number] Enter a value [Forward]</p> | <p>Press the Channel Number soft key. Use the numeric keys to input value and press the Forward soft key to complete the input. The instrument automatically displays its corresponding center frequency value for the channel number.</p> |
|---|--|

FREQ/DIST



- n **UNIT:** Determines the way how to set the frequency band either with standard band or custom frequency band. Toggling this key between **Freq** and **Channel** changes a set of Freq/Dist screen menu automatically.
- n **CENTER FREQUENCY:** Changes the center frequency setting. Use the rotary knob or the arrow keys. Or use the numeric keys to input a certain value and press one of the unit soft keys to complete the input.
- n **FREQUENCY STEP:** Defines the amount of frequency to be increased or decreased when using the rotary knob or the arrow keys to change the **Center Frequency**. This frequency step size can be entered by using numeric keys and the unit soft keys.
- n **CHANNEL NUMBER:** Enters a channel number. The instrument automatically displays its corresponding center frequency value for the channel number.
- n **CHANNEL STEP:** Defines the amount of channel to be increased or decreased when using the rotary knob or the arrow keys to change the **Channel Number**. This channel step size can be entered by using numeric keys and the **Enter** soft key.
- n **CHANNEL STANDARD:** When the channel standard is selected from the list, the center frequency information on the display screen will be mapped accordingly to the selected channel standard. The channel standards available in the instrument are listed in the Appendix C – Band, Frequency & Channel Standard.

Setting Amplitude

| Step | Description |
|--|--|
| <p>1. Set the reference/attenuation level AMP/SCALE [Auto Scale]</p> <p>or</p> | <p>Press the AMP/SCALE hard key. Press the Auto Scale soft key to automatically set optimum levels of reference and attenuation.</p> |

| | |
|---|---|
| <p>[Reference Level] Enter a reference level value</p> | <p>Press the Reference Level soft key to set manually. Use the numeric keys or the rotary knob that changes in a 10 dB step.</p> |
| <p>[dBm] or ENTER</p> | <p>Press the dBm soft key or the ENTER hard key.</p> |
| <p>[Attenuation] <Manual></p> | <p>Press the Attenuation soft key. The Auto mode is set by default. This key toggles between the Auto and Manual. Press the Attenuation soft key to highlight the Manual mode and change the attenuation value to optimize S/N.</p> |
| <p>Enter an attenuation value</p> | <p>Use the numeric keys or the rotary knob that changes in a 5 dB step. The attenuation setting range is 0 to 50 dB.</p> |

AMP/SCALE 

- n **AUTO SCALE:** The instrument can automatically set the scale to the minimum and maximum values on the Y-axis of the graph for optimum display of the traces measured. Each time the **Auto Scale** is selected, the top and bottom scales are set to the minimum and maximum values with margin on the Y-axis of the display screen.
- n **REFERENCE:** Sets the display of measurement result to relative or absolute value. Toggle between **Abs** for absolute and **Rel** for relative. *This key is used in the OTA Code Domain Power mode and the Route Map mode.*
 - Y **ABS:** The code domain power is measured absolute to channel power.
 - Y **REL:** The code domain power is measured relative to channel power.
- n **REFERENCE LEVEL:** Sets the maximum Y-axis range. In the OTA Code Domain Power mode, this key is activated only when the **Reference** is set to absolute mode. *This key is used in the OTA Channel Scanner mode and the OTA Code Domain Power mode.*
- n **ATTENUATION**
 - Y **AUTO:** Input attenuator's value is automatically set depending on the reference level. This is the default operation mode, so it is recommended to use this mode unless a special measurement condition is needed.
 - Y **MANUAL:** Sets the attenuator's value for the **Spectrum Analyzer RF In 50 Ω** port.
- n **PREAMP:** Turns on or off the internal pre-amplifier. Preamp results in a correction being applied to compensate for the gain of the preamp so that amplitude readings show the value at the input connector. This soft key toggles between the **On** and **Off**. When it is set to On, the allowable attenuation input range is from 0 dB to 10 dB in a multiple of 5. If the attenuation value is manually set greater than 10 dB, the instrument will automatically turn off the pre-amplifier to display low level signal properly on the screen.

- n **EXTERNAL OFFSET:** Sets an external offset value. An offset consists of a cable loss and a user offset and the measurement result shows the value reflecting both offset values. When the external offset value is set at 40 dB in the Spectrum mode, the measurement result compensates 40 dB at both the Spectrum Analyzer and Signal Analyzer modes.

Setting Sweep Mode



This hot key is used to set the sweep parameters. The user input window must be inactive first to get the Sweep hot key function other than the number input.

- n **SWEEP MODE:** Sets the sweep method. Toggle between **Continue** and **Single**.

| Step | Description |
|---|---|
| 1. Set the sweep mode SWEEP [Sweep Mode] | Press the SWEEP hot key. Press the Sweep Mode soft key. Toggle between Continue and Single . |

Setting Trigger Source



This hot key is used to select the trigger source among **Internal**, **External**, and **GPS**. The user input window must be inactive first to get the Trigger hot key function other than the number input. For OTA measurement, a GPS antenna should be connected and the trigger source should be set to **GPS**.

Setting External Clock

To enhance the reliability of modulation analysis measurements the JD740A series must be synchronized with the Base Station. When an external clock is not supplied, the JD740A series works with a built-in internal high-accuracy time base. In this case, some measurement results may exhibit inaccurate values. Therefore, it is highly recommended to use the same reference clock as signal source. Trigger mode can be changed by using the **TRIGGER** hot key.

EXTERNAL CLOCK OPERATING STANDARDS

| Clock | Type | Reference | Port | Switching Standard |
|--------------------|----------|--------------------|---------------|--|
| External Reference | Internal | Internal 10 MHz | | Default |
| | External | External Ref Clock | Ext Ref (SMA) | Manual switching (Input signal level >-3 dBm) |
| | GPS | GPS Clock | GPS (SMA) | Automatic switching (GPS signal received) |
| Trigger | Internal | Internal Trigger | | Default |
| | External | External Trigger | Trigger (SMA) | Manual switching |
| | GPS | GPS | GPS (SMA) | Manual switching |

CONNECTION

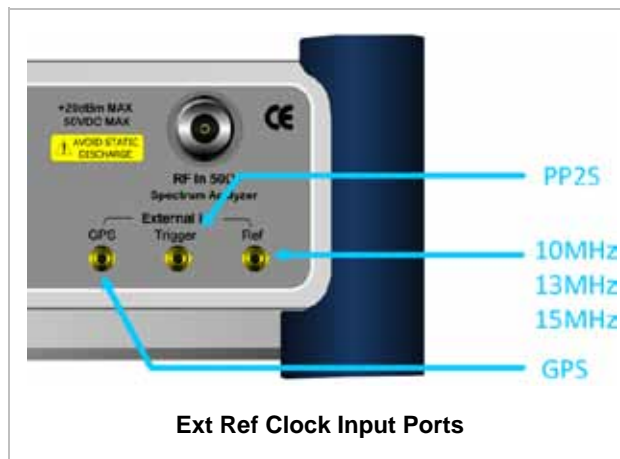



ENABLING GPS EXTERNAL REFERENCE

| Step | Description |
|--|--|
| 1. Connect a GPS antenna | Connect a GPS antenna to the JD740A series. |
| 2. Change reference clock SYSTEM [Frequency Reference] [GPS] | Press the SYSTEM hot key. Press the Frequency Reference soft key. Press the GPS soft key to perform OTA measurements. |

GPS EXTERNAL REFERENCE INDICATOR INFORMATION

When a GPS antenna is connected, the instrument automatically detects it. Each indicator tells different locking status depending on its connection. If it is successfully locked, the instrument will display "GPS" and longitude and latitude information on the screen. If it is unlocked or the antenna is disconnected, the display will be automatically switched to "Internal".

| Type | Indicator | Description |
|------|--|----------------------------------|
| GPS |  (Green) | Locked |
| |  (Yellow) | Locking in progress |
| |  (Gray) | Unable to lock or antenna failed |

CDMA OTA CHANNEL SCANNER

Measurement Procedure

| Step | Description |
|---|--|
| 1. Set the measurement mode MEASURE [OTA] [Channel Scanner] | Press the MEASURE hot key. Press the OTA soft key. Press the Channel Scanner soft key. |
| 2. Set the frequency FREQ/DIST [Edit List] [Add] or [Delete] | Press the FREQ/DIST hard key. Press the Edit List soft key to add, delete, or edit the list of channels to be scanned and a list of channels will pop up. Press the Add soft key to add a channel to the list. To change a channel standard, use the rotary knob to highlight the channel standard and then press the center of the rotary knob or the ENTER hard key. In the band list pop-up window, use the rotary knob or the arrow keys to highlight a channel band and then press the center of the rotary knob or the ENTER hard key. To change the channel number or frequency, use the rotary knob to highlight the channel number or the frequency and then press the center of the rotary knob or the ENTER hard key. Use numeric keys to enter a value and then press the ENTER hard key to complete the entry. In the Edit List window, use the rotary knob or the arrow keys to highlight a channel to delete and then press the Delete hard key. |

| | |
|--|---|
| <p>3. Set the reference/attenuation level AMP/SCALE [Auto Scale]</p> | <p>Press the AMP/SCALE hard key. Press the Auto Scale soft key to automatically set optimum levels of reference and attenuation. Do this setting after measuring all the selected channels to have optimized reference level and attenuation level.</p> |
| <p>4. Set the measurement parameters MEASURE SETUP [PN Increment] Enter a value [Enter]</p> | <p>Press the MEASURE SETUP hot key. Press the PN Increment soft key. Use the numeric keys to input value. Press the Enter soft key.</p> |

CDMA OTA Channel Scanner Measurement Procedure

FREQ/DIST 

- n **EDIT LIST:** Adds new channel(s) to be measured or deletes or edits existing channel standard(s) in the pop-up list window.

MEASURE SETUP 

- n **PN INCREMENT:** Sets the increment step for the PN Offset. Use the numeric keys to enter a value and press the **Enter** soft key or the **ENTER** hard key to complete to the input.

Setting Limit

LIMIT 

This hot key is used to set the threshold value for the limit line on the display screen. It turns on or off the limit or band limit settings of the measurement for pass/fail indication. The user input window must be inactive first to get the Limit hot key function other than the number input.

| Step | Description |
|---|--|
| <p>1. Select the limit line LIMIT [Limit Line] <On> or <Off> Enter a value [dBm] or ENTER</p> | <p>Press the LIMIT hot key. Press the Limit Line soft key to toggle between On and Off. This will enable or disable the limit line on the display screen. Use the numeric keys to input value.</p> |

Press the **dBm** unit soft key or the **ENTER** hard key.

- n **LIMIT LINE:** Enables or disables the test limit. Toggle the **Limit Line** soft key between **On** and **Off**. When the display line is set to on, use the numeric keys to enter a limit value and then press the **dBm** unit soft key or the **ENTER** hard key.

Measurement Example

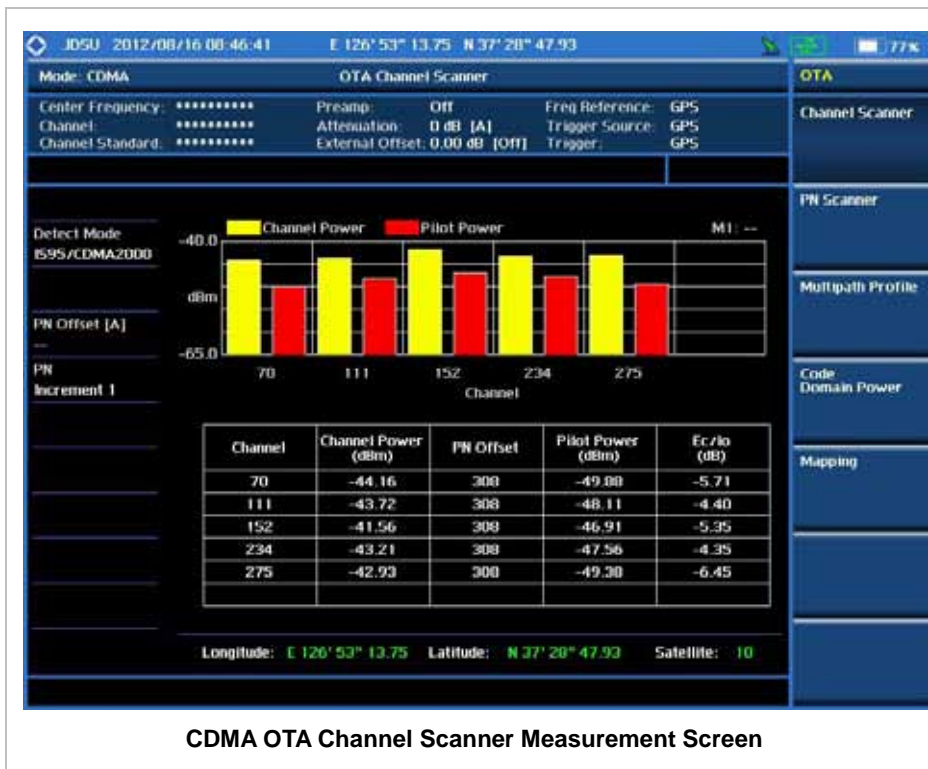

CDMA OTA PN SCANNER

Each access network sector has a unique PN offset. The PN Scanner is used to identify all active PNs in the area.

Measurement Procedure

| Step | Description |
|-----------------------------|-------------|
| 1. Set the measurement mode | |

| | |
|--|--|
| <p>MEASURE [OTA] [PN Scanner]</p> | <p>Press the MEASURE hot key. Press the OTA soft key. Press the PN Scanner soft key.</p> |
| <p>2. Set the measurement parameters MEASURE SETUP [PN Increment] Enter a value [Enter] [Auto Save] <On> or <Off></p> | <p>Press the MEASURE SETUP hot key. Press the PN Increment soft key. Use the numeric keys to input value. Press the Enter soft key. Press the Auto Save soft key. Toggle between On and Off.</p> |

CDMA OTA PN Scanner Measurement Procedure

MEASURE SETUP 

- n **PN INCREMENT:** Sets the increment step for the PN Offset. Use the numeric keys to enter a value and press the **Enter** soft key or the **ENTER** hard key to complete to the input.
- n **AUTO SAVE:** Enables or disables automatic saving of the measurement data to an external USB memory. When it turns on, the measurements will be recorded into the default file (logging.ota) or a user-named file.

Measurement Example

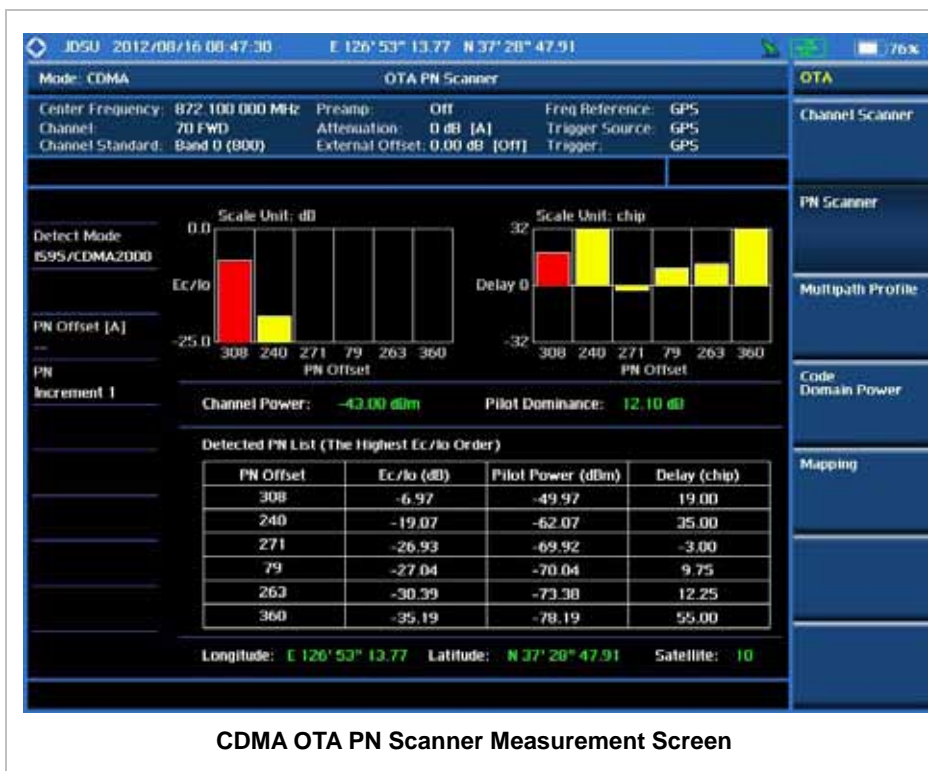

CDMA OTA PN Scanner Measurement Screen

CDMA OTA MULTIPATH PROFILE

The Multipath Profile enables the user to determine RF environmental conditions of testing area. It indicates the amount of power of the dominant pilot signal that is dispersed outside the main correlation peak due to multipath echoes that are expressed in dB. This value should be very small ideally.

The multipath profile is the result of portions of the original broadcast signal arriving at the receiving antenna out of phase. This can be caused by the signal being reflected off objects such as buildings, or being refracted through the atmosphere differently from the main signal.

Measurement Procedure

| Step | Description |
|---|--|
| 1. Set the measurement mode MEASURE [OTA] [Multipath Profile] | Press the MEASURE hot key. Press the OTA soft key. Press the Multipath Profile soft key. |
| 2. Set the measurement parameters MEASURE SETUP [PN Increment] Enter a value [Enter] | Press the MEASURE SETUP hot key. Press the PN Increment soft key. Use the numeric keys to input value. Press the Enter soft key. |

CDMA OTA Multipath Profile Measurement Procedure

MEASURE SETUP



- n **PN INCREMENT:** Sets the increment step for the PN Offset. Use the numeric keys to enter a value and press the **Enter** soft key or the **ENTER** hard key to complete to the input.

Measurement Example

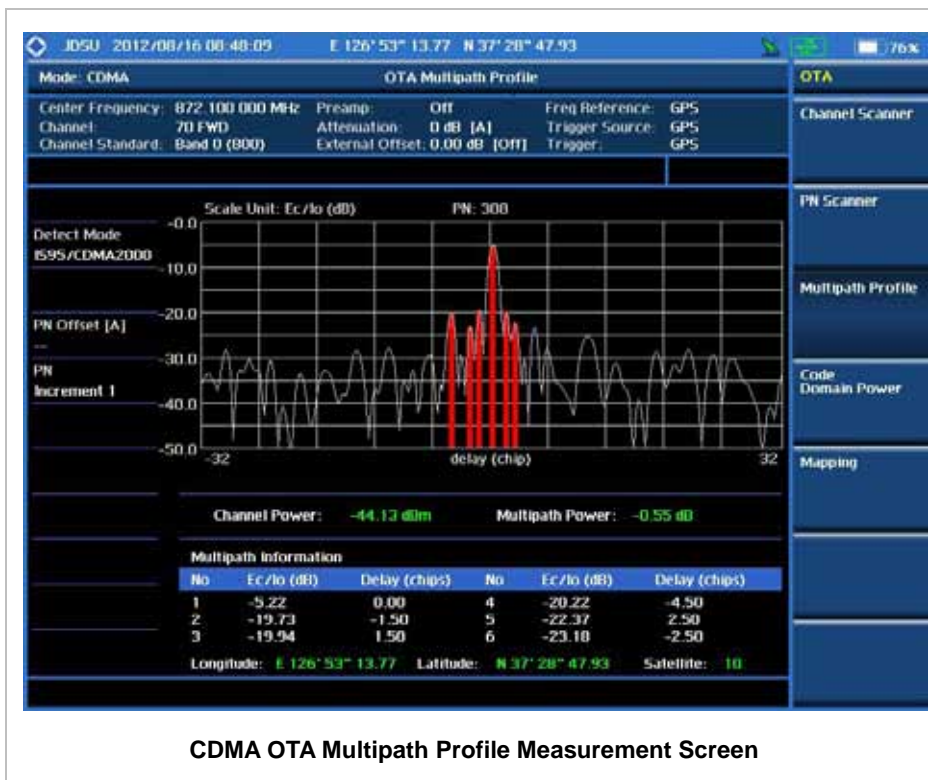

CDMA OTA Multipath Profile Measurement Screen

CDMA OTA CODE DOMAIN POWER

Channels with high correlation factors are determined to be active channels and are indicated as such on the display. Once the channels are decoded, the analyzer determines the power of each channel relative to the total signal power.

This measurement helps to verify that each code channel is operating at its proper level and helps to identify problems throughout the transmitter design from the coding to the RF section. System imperfections, such as the non-linearity of amplifiers, will present themselves as an undesired distribution of power in the code domain.

Measurement Procedure

| Step | Description |
|---|---|
| 1. Set the measurement mode MEASURE [OTA] [Code Domain Power] | Press the MEASURE hot key. Press the OTA soft key. Press the Code Domain Power soft key. |

2. Set the measurement parameters

MEASURE SETUP**[PN Offset]**

<Auto> or <Manual>

Enter a value

[Enter]**[PN Increment]**

Enter a value

[Enter]**[Threshold]**

Enter a value

[dB]**[Q-Paging]**

<On> or <Off>

[Max Amplifier Power]

Enter a value

[dBm]**[Pilot Power]**

Enter a value

[dBm]**[More (1/2)]****[Pilot Dominance >]**

Enter a value

[dB]**[Multipath Power <]**

Enter a value

[dB]**[Auto Save]**

<On> or <Off>

Press the **MEASURE SETUP** hot key.Press the **PN Offset** soft key. The **Auto** mode is set by default. Toggle between **Auto** and **Manual**.

Use the numeric keys to input value.

Press the **Enter** soft key.Press the **PN Increment** soft key.

Use the numeric keys to input value.

Press the **Enter** soft key.Press the **Threshold** soft key.

Use the numeric keys to input value.

Press the unit soft key.

Press the **Q-Paging** soft key. Toggle between **On** and **Off**.Press the **Max Amplifier Power** soft key.

Use the numeric keys to input value.

Press the unit soft key.

Press the **Pilot Power** soft key.

Use the numeric keys to input value. It is important to enter an exact value of the Max Amplifier Power/Pilot Power for the base station to be measured.

Press the unit soft key.

Press the **More (1/2)** soft key to display more soft keys.Press the **Pilot Dominance >** soft key.

Use the numeric keys to input value. 10 is recommended.

Press the unit soft key.

Press the **Multipath Power <** soft key.

Use the numeric keys to input value. 1 is recommended.

Press the unit soft key.

Press the **Auto Save** soft key. Toggle between **On** and **Off**.**CDMA OTA Code Domain Power Measurement Procedure**

MEASURE SETUP



- n **PN OFFSET:** Sets the PN Offset (Pseudo-Noise Offset) to **Auto** or **Manual**. Toggle between **Auto** and **Manual**. To change the value in the **Manual** mode, use the numeric keys and press the **Enter** soft key or the **ENTER** hard key to complete to the input.
- n **PN INCREMENT:** Sets the increment step for the PN Offset. Use the numeric keys to enter a value and press the **Enter** soft key or the **ENTER** hard key to complete to the input.
- n **TRHESHOLD:** Sets the threshold value between Auto and Manual. Its default setting is -27 dB. To change the value in the **Manual** mode, use the numeric keys to enter a value between -50 and 0 and press the **Enter** soft key or the **ENTER** hard key to complete to the input.
- n **Q-PAGING:** Enable or disable the quick page channel that indicates the power of Quick Page Walsh code 80. Toggle between **On** and **Off**.
- n **MAX AMPLIFIER POWER:** Sets the maximum amplifier power. Press this soft key and rotate the knob or press the arrow keys to enter a value. Or use the numeric keys and press the **dBm** unit soft key to complete the input.
- n **PILOT POWER:** Sets the pilot power. Press this soft key and rotate the knob or press the arrow keys to enter a value. Or use the numeric keys and press the **dBm** unit soft key to complete the input.
- n **PILOT DOMINANCE >:** Sets the threshold for pilot dominance. 10 is recommended. Color of the Pilot Dominance indicator on the left bottom corner of the screen is based on this set value.
- n **MULTIPATH POWER <:** Sets the threshold for multipath power. 1 is recommended. Color of the Multipath Power indicator on the left bottom corner of the screen is based on this set value.
- n **AUTO SAVE:** Enables or disables automatic saving of the measurement data to an external USB memory. When it turns on, the measurements will be recorded into the default file (logging.ota) or a user-named file.

Setting Limit

LIMIT



This hot key is used to set the threshold value for the limit line on the display screen. It turns on or off the limit or band limit settings of the measurement for pass/fail indication. The user input window must be inactive first to get the Limit hot key function other than the number input.

| Step | Description |
|---------------------|-------------|
| 1. Select the limit | |

| | |
|---|--|
| <p>LIMIT</p> <p>[Modulation Test Limits]</p> <p>[Frequency Error]</p> <p> [Test Limits]</p> <p> <On> or <Off></p> <p> [High Limit]</p> <p> [Low Limit]</p> <p>[Time Offset]</p> <p> [Test Limits]</p> <p> <On> or <Off></p> <p> [High Limit]</p> <p> [Low Limit]</p> <p>[Rho]</p> <p> [Test Limit]</p> <p> <On> or <Off></p> <p> [Low Limit]</p> <p>[Carrier Feed Through]</p> <p> [Test Limit]</p> <p> <On> or <Off></p> <p> [High Limit]</p> <p>[Pilot Power]</p> <p> [Test Limits]</p> <p> <On> or <Off></p> <p> [High Limit (Abs)]</p> <p> [Low Limit (Abs)]</p> <p> or</p> <p> [High Limit (Rel)]</p> <p> [Low Limit (Rel)]</p> <p>[Max Inactive]</p> <p> [Test Limit]</p> <p> <On> or <Off></p> <p> [High Limit]</p> | <p>Press the LIMIT hot key.</p> <p>Press the Modulation Test Limits soft key.</p> <p>Press the Frequency Error soft key.</p> <p>Press the Test Limits soft key. Toggle between On and Off.</p> <p>Use the numeric keys and input a number in ppm.</p> <p>Use the numeric keys and input a number in ppm.</p> <p>Press the Time Offset soft key.</p> <p>Press the Test Limits soft key. Toggle between On and Off.</p> <p>Use the numeric keys and input a number in us.</p> <p>Use the numeric keys and input a number in us.</p> <p>Press the Rho soft key.</p> <p>Press the Test Limit soft key. Toggle between On and Off.</p> <p>Use the numeric keys and input a number.</p> <p>Press the Carrier Feed Through soft key.</p> <p>Press the Test Limit soft key. Toggle between On and Off.</p> <p>Use the numeric keys and input a number in dB.</p> <p>Press the Pilot Power soft key.</p> <p>Press the Test Limits soft key. Toggle between On and Off.</p> <p>Use the numeric keys and input a number in dBm.</p> <p>Use the numeric keys and input a number in dBm.</p> <p>Use the numeric keys and input a number in dB.</p> <p>Use the numeric keys and input a number in dB.</p> <p>Press the Max Inactive soft key.</p> <p>Press the Test Limit soft key. Toggle between On and Off.</p> <p>Use the numeric keys and input a number in dB.</p> |
| <p>2. Enable beep</p> <p>LIMIT</p> <p> [Beep]</p> <p> <On> or <Off></p> | <p>Press the LIMIT hot key.</p> <p>Press the Beep soft key to toggle between On and Off and select one. This will make audible alarm if the measurement result goes beyond the limit.</p> |

n **FREQUENCY ERROR:** Sets the frequency error limit.

- Y **TEST LIMITS:** Enables or disables the test limits. Toggle the **Test Limits** soft key between **On** and **Off**.
- Y **HIGH LIMIT:** Sets the upper limit. Use the numeric keys to input value and press the unit soft key or the **ENTER** hard key to complete the input.
- Y **LOW LIMIT:** Sets the lower limit. Use the numeric keys to input value and press the unit soft key or the **ENTER** hard key to complete the input.
- n **TIME OFFSET:** Sets the time offset limit. Time Offset compares the PN offset timing with the overall system time and the instrument checks the start of PN offset in comparison to either the GPS signal or the even second clock signal.
 - Y **TEST LIMITS:** Enables or disables the test limits. Toggle the **Test Limits** soft key between **On** and **Off**.
 - Y **HIGH LIMIT:** Sets the upper limit. Use the numeric keys to input value and press the unit soft key or the **ENTER** hard key to complete the input.
 - Y **LOW LIMIT:** Sets the lower limit. Use the numeric keys to input value and press the unit soft key or the **ENTER** hard key to complete the input.
- n **RHO:** Sets the waveform quality (Rho) limit. Rho measures the modulation quality for a CDMA transmitter along with EVM and Walsh Channel Power. It includes all errors occurred along the transmitter chain such as base band filtering, abnormality of I/Q modulator and distortion in power amplifier. A perfect Rho value is 1.0 indicating that all of the power is being transmitted correctly.
 - Y **TEST LIMIT:** Enables or disables the test limit. Toggle the **Test Limit** soft key between **On** and **Off**.
 - Y **LOW LIMIT:** Sets the lower limit. Use the numeric keys to input value and press the unit soft key or the **ENTER** hard key to complete the input.
- n **CARRIER FEED THROUGH:** Sets the limit of carrier feed through. Carrier Feed Through is a result of the RF carrier signal feeding through the I/Q modulator and riding on the output circuitry without being modulated. It sets the limit of carrier feed through.
 - Y **TEST LIMIT:** Enables or disables the test limit. Toggle the **Test Limit** soft key between **On** and **Off**.
 - Y **HIGH LIMIT:** Sets the upper limit. Use the numeric keys to input value and press the unit soft key or the **ENTER** hard key to complete the input.
- n **PILOT POWER:** Sets the pilot power limit.
 - Y **TEST LIMITS:** Enables or disables the test limits. Toggle the **Test Limits** soft key between **On** and **Off**.
 - Y **HIGH LIMIT (ABS):** Sets the upper absolute limit. Use the numeric keys to input value and press the unit soft key or the **ENTER** hard key to complete the input.

- Y **LOW LIMIT (ABS):** Sets the lower absolute limit. Use the numeric keys to input value and press the unit soft key or the **ENTER** hard key to complete the input.
- Y **HIGH LIMIT (REL):** Sets the upper relative limit. Use the numeric keys to input value and press the unit soft key or the **ENTER** hard key to complete the input.
- Y **LOW LIMIT (REL):** Sets the lower relative limit. Use the numeric keys to input value and press the unit soft key or the **ENTER** hard key to complete the input.
- n **MAX INACTIVE:** Sets the limit of the highest level among inactive channels.
- Y **TEST LIMIT:** Enables or disables the test limit. Toggle the **Test Limit** soft key between **On** and **Off**.
- Y **HIGH LIMIT:** Sets the upper limit. Use the numeric keys to input value and press the unit soft key or the **ENTER** hard key to complete the input.

Setting Display

TRACE/DISPLAY 

- n **CODE ORDER:** Selects the code order.
 - Y **HADAMARD:** Assigns the number based on Walsh code order and displays the measured code power according to the assigned number in sequence.
 - Y **BIT REVERSE:** Code number in binary bit is reversed relative to the Hadamard method.
- n **BASE CODE LENGTH:** Selects the base Walsh code length between **64** and **128**. Each time this soft key is pressed, the highlighted selection changes.

Measurement Example

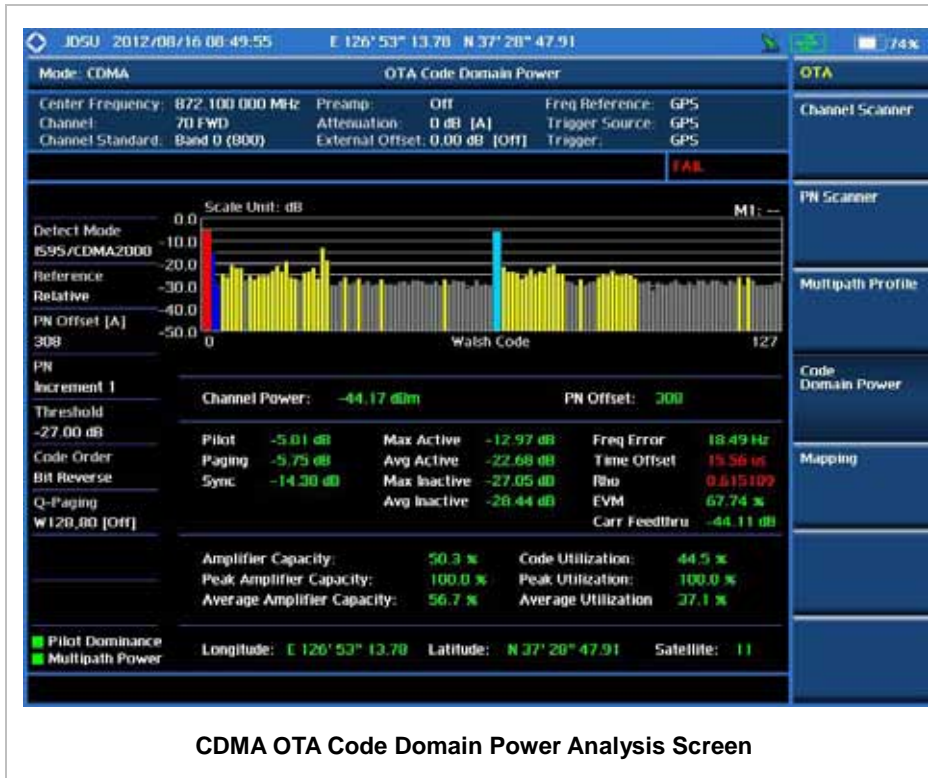

CDMA OTA Code Domain Power Analysis Screen

CDMA ROUTE MAP

The JD740A Series provides indoor and outdoor mapping function that allows a user to collect data of points in an indoor or outdoor environment and track the received signals and coverage of RF transmitters plotting real time directly on top of a loaded floor plan or a map.

Measurement Procedure

| Step | Description |
|---|--|
| 1. Set the measurement mode MEASURE [OTA] [Route Map] | Press the MEASURE hot key. Press the OTA soft key. Press the Route Map soft key. |
| 2. Set the measurement parameters MEASURE SETUP [Load Map] | Press the MEASURE SETUP hot key. After plugging in a USB drive, press the Load Map soft key to load a map file created in JDMAPCreator and copied into the USB drive. |

| | |
|---|--|
| <p>[Plot Point] [Position] or [GPS]</p> | <p>Press the Plot Point soft key to get option menu. Press the Position soft key without a GPS antenna or the GPS with one. Selecting GPS activates the Screen Mode soft key to be set.</p> |
| <p>[Plot Item] [Pilot Power] or [Ec/Io]</p> | <p>Press the Plot Item soft key. Select either Pilot Power or Ec/Io as needed.</p> |
| <p>[Screen Mode] <Map> or <Full></p> | <p>Press the Screen Mode soft key. Toggle this key between Map and Full.</p> |
| <p>[PN Increment] Enter a value [Enter]</p> | <p>Press the PN Increment soft key. Use the numeric keys to input value. Press the Enter soft key.</p> |
| <p>[Plot] <Start> or <Stop></p> | <p>Press the Plot soft key to start or stop plotting. Toggle this key between Start and Stop.</p> |

MEASURE SETUP



Sets the measurement parameters for the Route Map. The legend displayed in different colors at the bottom of the screen can be set with the **Limit** hot key.

- n **PLOT:** Starts or stops a measurement in order to plot received signals or collected data on top of a loaded map. Toggle this key between **Start** and **Stop**. The instrument does not automatically save collected data. After stopping the current route mapping, the user needs to save the result with the **Save** hot key for later use. If not, all the collected data for the route will be lost.
- n **PLOT POINT:** Selects a method of plotting points.
 - Y **POSITION:** Measures data without GPS in an indoor environment. After starting to plot, press the **Enter** hard key or the center of the rotary knob as you move with the instrument. Each time the user presses the key or the knob, the instrument plots a point on top of the loaded map. Use the arrow keys to change direction of route and the rotary knob to change distance. If the instrument has the screen with touch screen, directly touch the screen in order to collect data.
 - Y **GPS:** Automatically collects data with GPS in an outdoor environment and plots points as the user moves in a vehicle.
- n **PLOT ITEM:** Selects either **Pilot Power** or **Ec/Io**. The instrument collects the strongest PN data from its PN Scanner and plots them.
- n **SCREEN MODE:** Selects either **Map** or **Full**, depending on how to show collected points on the screen. Selecting GPS for the Plot Point activates this key. Numbers shown next to the points

represent their PN offsets. The instrument displays PN offset of the start point and those of the points with different PN offsets from the right previous ones.

- Y **MAP:** Displays collected points only that can be seen within the boundary of the loaded map. If a point is off the map, the instrument displays an arrow indicating the direction of the current location on the map and the distance from the center to the location at the top of the screen.
- Y **FULL:** Displays all the measured points for the route on the screen without the map.
- n **LOAD MAP:** Loads a floor plan or a map file created in **JDMapCreator**. The JDMapCreator converts and resizes any scanned floor plan or layout so that it can be loaded and fit to the instrument display.
- n **PN INCREMENT:** Sets the increment step for the PN Offset. Use the numeric keys to enter a value and press the **Enter** soft key or the **ENTER** hard key to complete to the input.

Setting Limit



This hot key is used to set threshold values for the legend displayed on the screen. The different colors of the legend indicate the quality of the measured data depending on their threshold setting. The user input window must be inactive first to get the Limit hot key function other than the number input.

| Step | Description |
|----------------------|---|
| 1. Set the limit | |
| Limit | Press the LIMIT hot key. |
| [Pilot Power] | Press the Pilot Power soft key to set its threshold. |
| [Excellent] | Press the Excellent soft key. |
| Enter a value | Use the rotary knob or the numeric keys. |
| [Enter] | Press the Enter soft key. |
| [Very Good] | Press the Very Good soft key. |
| Enter a value | Use the rotary knob or the numeric keys. |
| [Enter] | Press the Enter soft key. |
| [Good] | Press the Good soft key. |
| Enter a value | Use the rotary knob or the numeric keys. |
| [Enter] | Press the Enter soft key. |
| [Fair] | Press the Fair soft key. |
| Enter a value | Use the rotary knob or the numeric keys. |
| [Enter] | Press the Enter soft key. |
| [Poor] | Press the Poor soft key. |
| Enter a value | Use the rotary knob or the numeric keys. |

| | |
|-----------------------|--|
| <p>[Enter]</p> | <p>Press the Enter soft key.</p> |
| <p>[Ec/Io]</p> | <p>Press the Ec/Io soft key to set its threshold.</p> |
| <p>[Good]</p> | <p>Press the Good soft key.</p> |
| <p>Enter a value</p> | <p>Use the rotary knob or the numeric keys.</p> |
| <p>[Enter]</p> | <p>Press the Enter soft key.</p> |
| <p>[Fair]</p> | <p>Press the Fair soft key.</p> |
| <p>Enter a value</p> | <p>Use the rotary knob or the numeric keys.</p> |
| <p>[Enter]</p> | <p>Press the Enter soft key.</p> |
| <p>[Poor]</p> | <p>Press the Poor soft key.</p> |
| <p>Enter a value</p> | <p>Use the rotary knob or the numeric keys.</p> |
| <p>[Enter]</p> | <p>Press the Enter soft key.</p> |

Measurement Example



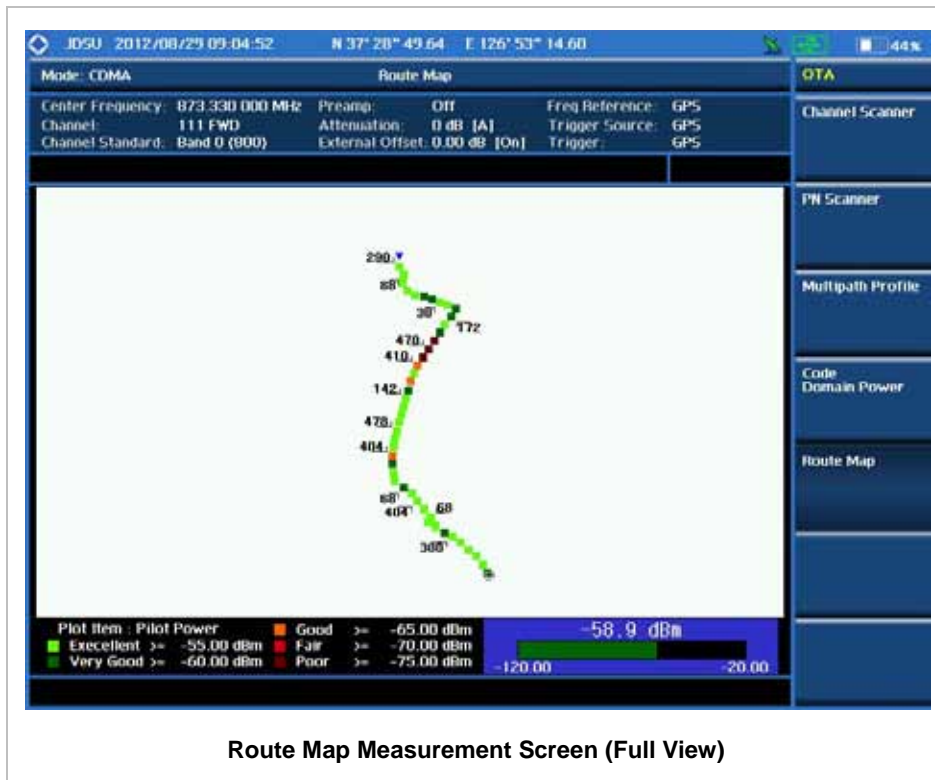

Route Map Measurement Screen (Full View)

ANALYSIS

Using Marker

MARKER



Marker is used to get the information about a specific trace. Six markers can be set on the display and each marker can be used independently. The X and Y coordinates of the trace are displayed when the marker is placed on any position of the trace. The position displaying the marker's X and Y coordinates may be slightly different for each measurement mode and refer to the description of each measurement. There are three different marker types available: Normal, Delta, and Delta pair. Marker position can be set manually by entering numeric values (frequency) when one of the marker types is selected.

- n **SELECT MARKER:** Selects an active marker whose position can be changed with the rotary knob or the arrow keys. The assigned number of the active marker is displayed in the **Select Marker** menu box and the active marker number is also displayed right next to the active marker on the trace when the **Marker View** is set to **On**.
- n **MARKER VIEW:** Displays the selected marker on the screen or hides it. When the **Marker View**

is turned off and then on again in the same measurement mode, markers appear at the previous positions. If a measurement mode is changed, markers are not restored to their previous positions.

- n **NORMAL:** This Normal marker type provides the reading of a marker position on the trace along with the marker number between 1 and 6.
- n **DELTA:** This Delta marker type is associated with a Normal marker. A Normal marker must be set before a Delta marker is set. When the Delta marker is set, the position set by the Delta marker becomes the reference position of the Normal marker and the marker's X and Y values displays the difference compared with the Delta marker.
- n **DELTA PAIR:** This Delta Pair marker type is associated with a Normal marker. A Normal marker must be set before a Delta Pair marker is set. When the Delta Pair marker is set, the position set by the Delta Pair marker becomes the reference position of the Normal marker and the marker's X and Y values displays the difference compared with the Delta Pair marker. The reference position will be varied in accordance with trace change.
- n **MARKER ALL OFF:** Turns all the markers the screen off. When the Marker View is selected for those markers, the instrument displays those markers back at the previous position. If a measurement mode is changed, current settings are not restored.
- n **MARKER \rightarrow :** Sets the X coordinate of the active marker as selected.
 - Y **MARKER \rightarrow CENTER:** Sets the frequency of the active marker to the center frequency of spectrum analyzer.
 - Y **MARKER \rightarrow START:** Sets the frequency of the active marker to the start frequency of spectrum analyzer.
 - Y **MARKER \rightarrow STOP:** Sets the frequency of the active marker to the stop frequency of spectrum analyzer.

Using Peak Search

PEAK SEARCH

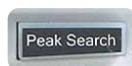

Each time the Peak Search soft key is pressed, the active marker is positioned at the highest peak of the trace.

- n **PEAK SEARCH:** Moves the active marker to the highest peak of the trace.
- n **NEXT PEAK:** Moves the active marker to the second highest peak of the trace.
- n **NEXT PEAK RIGHT:** Moves the active marker to the highest peak to the right of its current position.
- n **NEXT PEAK LEFT:** Moves the active marker to the highest peak to the left of its current position.

- n **MIN SEARCH:** Moves the active marker to the lowest peak of the trace.
- n **ALWAYS PEAK:** When the **Always Peak** is set to On, the instrument moves the active marker automatically to the highest peak of the trace every time the trace is refreshed.

EV-DO Signal Analyzer

This EV-DO Signal Analyzer function is optional that the JD740A series offers as the Option 021. It allows the user to analyze EV-DO system performance. The user may alter the measurement parameters for specialized analysis. The EV-DO OTA Analyzer which is the Option 041 can be added to the EV-DO Signal Analyzer for Over The Air measurement.

In this Chapter

| | |
|------------------------------------|----|
| Using EV-DO Signal Analyzer | 4 |
| Display Overview | 5 |
| Connecting a Cable | 7 |
| Direct Connection..... | 7 |
| Indirect Connection | 7 |
| Over The Air (OTA) | 8 |
| Spectrum Analysis Measurement..... | 9 |
| Setting Mode | 9 |
| Setting Frequency | 9 |
| Setting Amplitude | 10 |
| Setting Averaging | 11 |
| Setting Sweep Mode | 12 |
| Setting Trigger Source | 12 |
| Setting External Clock..... | 12 |
| Setting Trace and Display | 14 |
| Measurement Procedure | 15 |
| Measurement Example | 15 |
| RF Analysis Measurements..... | 15 |
| Setting Mode | 16 |
| Setting Frequency | 16 |
| Setting Amplitude | 17 |
| Setting Averaging | 19 |
| Setting Sweep Mode | 19 |
| Setting Trigger Source | 20 |
| Setting External Clock..... | 20 |
| Channel Power | 22 |
| Measurement Procedure | 22 |
| Setting Limit | 22 |
| Measurement Example | 23 |
| Occupied Bandwidth..... | 24 |
| Measurement Procedure | 24 |
| Setting Limit | 24 |
| Measurement Example | 25 |

| | |
|--|----|
| Spectrum Emission Mask (SEM)..... | 25 |
| Measurement Procedure | 26 |
| Setting Limit | 26 |
| Measurement Example | 26 |
| ACPR..... | 27 |
| Measurement Procedure | 27 |
| Setting Limit | 27 |
| Measurement Example | 28 |
| Multi-ACPR..... | 29 |
| Measurement Procedure | 29 |
| Setting Limit | 30 |
| Measurement Example | 31 |
| Spurious Emissions | 31 |
| Measurement Procedure | 31 |
| Setting Limit | 33 |
| Measurement Example | 34 |
| Power vs Time Analysis Measurements..... | 35 |
| Setting Mode | 35 |
| Setting Frequency | 35 |
| Setting Amplitude | 37 |
| Setting Averaging | 38 |
| Setting Sweep Mode | 38 |
| Setting Trigger Source | 38 |
| Setting External Clock..... | 39 |
| Power vs Time (Idle Slot)..... | 40 |
| Measurement Procedure | 40 |
| Setting Limit | 41 |
| Measurement Example | 42 |
| Power vs Time (Active Slot)..... | 43 |
| Measurement Procedure | 43 |
| Setting Limit | 43 |
| Measurement Example | 45 |
| Modulation Analysis Measurements..... | 46 |
| Setting Mode | 46 |
| Setting Frequency | 47 |
| Setting Amplitude | 48 |
| Setting Sweep Mode | 49 |
| Setting Trigger Source | 50 |
| Setting External Clock..... | 50 |
| Constellation..... | 52 |
| Measurement Procedure | 52 |
| Setting Limit | 53 |
| Measurement Example | 55 |
| Code Domain Power | 58 |
| Measurement Procedure | 58 |
| Setting Limit | 59 |
| Measurement Example | 60 |
| MAC Codogram..... | 62 |
| Measurement Procedure | 63 |
| Measurement Example | 64 |
| RCSI | 65 |
| Measurement Procedure | 65 |
| Measurement Example | 67 |

| | |
|-----------------------------------|-----|
| MAC CDP Table..... | 67 |
| Measurement Procedure | 67 |
| Measurement Example | 68 |
| Setting Display | 69 |
| Auto Measurement | 69 |
| Setting Mode | 70 |
| Setting Frequency | 70 |
| Setting Trigger Source | 71 |
| Setting External Clock..... | 71 |
| Setting Limit | 73 |
| Measurement Procedure | 75 |
| Setting Display | 77 |
| Power Statistics CCDF | 77 |
| Setting Mode..... | 78 |
| Setting Frequency..... | 78 |
| Setting Amplitude | 79 |
| Setting Sweep Mode | 80 |
| Setting Trigger Source | 80 |
| Setting External Clock..... | 81 |
| Measurement Procedure | 82 |
| Measurement Example | 83 |
| EV-DO OTA Measurements..... | 83 |
| Setting Mode | 84 |
| Setting Frequency | 84 |
| Setting Amplitude | 85 |
| Setting Sweep Mode | 87 |
| Setting Trigger Source | 87 |
| Setting External Clock..... | 87 |
| EV-DO OTA Channel Scanner..... | 89 |
| Measurement Procedure | 89 |
| Setting Limit | 90 |
| Measurement Example | 91 |
| EV-DO OTA PN Scanner | 91 |
| Measurement Procedure | 91 |
| Measurement Example | 92 |
| EV-DO OTA Multipath Profile..... | 93 |
| Measurement Procedure | 93 |
| Measurement Example | 93 |
| EV-DO OTA Code Domain Power | 94 |
| Measurement Procedure | 94 |
| Setting Limit | 96 |
| Measurement Example | 98 |
| EV-DO Route Map..... | 99 |
| Measurement Procedure | 99 |
| Setting Limit | 101 |
| Measurement Example | 102 |
| Analysis | 103 |
| Using Marker..... | 103 |
| Using Peak Search | 104 |

(Rev. 6.0)

.....

USING EV-DO SIGNAL ANALYZER

The EV-DO Signal Analyzer of the JD740A series performs power and spectrum measurements as well as modulation analysis to test the proper transmitter performance of EV-DO systems. It performs conformance testing according to the following standards providing a simple Pass/Fail indication on each test.

- n 3GPP2 C.S0024-B. CDMA2000 High Rate Packet Data Air Interface Specification
- n 3GPP2 C.S0032-B. Recommended Minimum Performance Standards for CDMA2000 High Rate Packet Data Access Network

The EV-DO Signal Analyzer provides the following analysis tools for EV-DO system. The user may alter the measurement parameters for specialized analysis.

- n Spectrum Analysis
- n RF Analysis
 - Y Channel Power
 - Y Occupied Bandwidth
 - Y Spectrum Emission Mask
 - Y Adjacent Channel Power Ratio (ACPR)
 - Y Multi-ACPR
 - Y Spurious Emissions
- n Power vs Time (Idle Slot and Active Slot)
- n Modulation Analysis
 - Y Constellation
 - Y Code Domain Power (CDP)
 - Y MAC Codogram
 - Y Received Code Strength Indicator (RCSI)
 - Y MAC CDP Table
- n Auto Measure
- n Power Statistics CCDF

- n Over The Air (OTA)
 - Y Channel Scanner
 - Y PN Scanner
 - Y Multipath Profile
 - Y Code Domain Power
 - Y Route Map

DISPLAY OVERVIEW

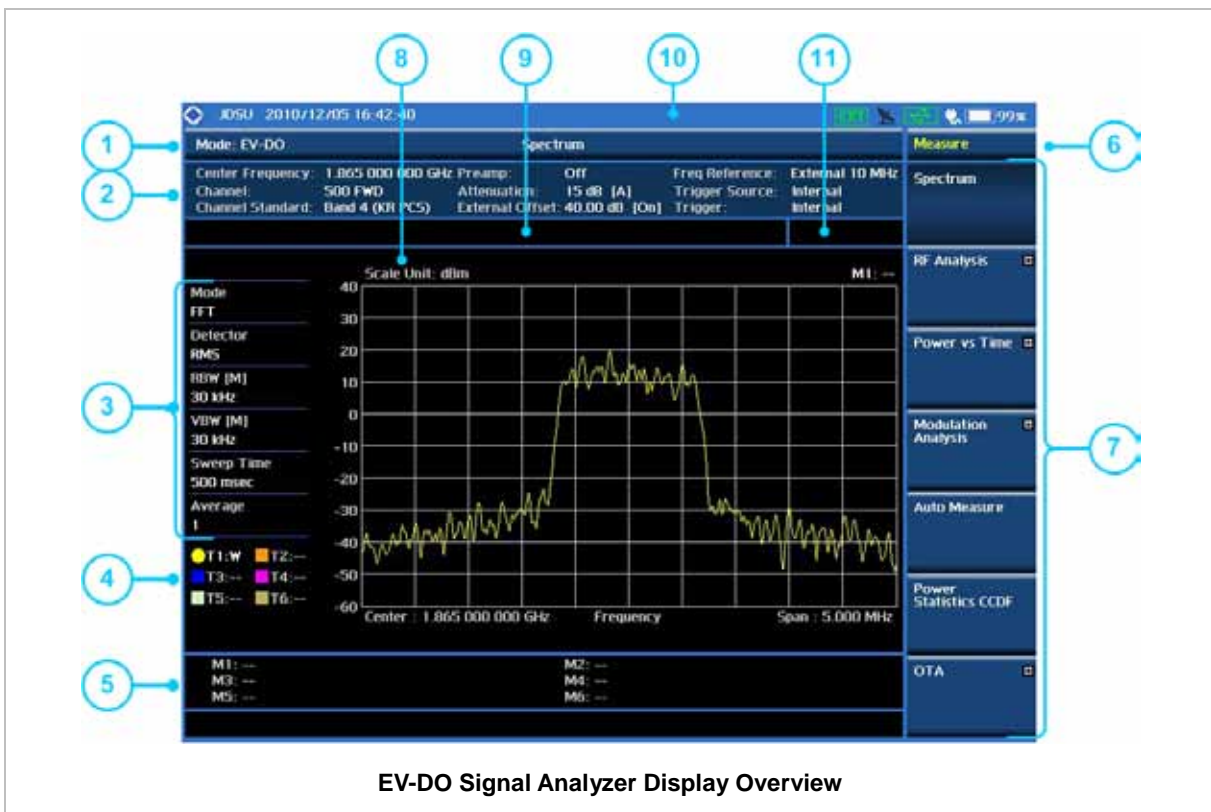

Measurement Mode Information: EV-DO Signal Analyzer

Spectrum Input Level Setting Information: This window shows the most common settings or parameters of each measurement.

- Frequency and Channel Setting
- Amplitude Setting (Preamp, Attenuation, External Offset)
- Reference Setting (Frequency, Trigger)

Measurement Setting Information

- Spectrum Analyzer Operation Mode Information
- Detector Type Setting Information
- Spectrum Setting Information (RBW, VBW)
[A]: Auto mode, [M]: Manual mode
- Sweep Time Information: Displays current sweep time
- Average Number Information set through BW/AVG hard key. It shows the number of traces to be averaged.

Trace Information

- C: Captured
- M: Max Hold
- m: Min Hold
- W: Write Current Trace (Indicates current active trace)
- L: Loaded
- F: Trace View Off

Information on Marker Table displays up to 6 markers

Screen Menu Title

Screen Menu and Sub-menu

Scale Unit Information: dBm, dBV, dBmV, dBuV, V, and W

User Input Window: Activates when user input menu or key is selected. Pressing ESC hard key will cancel or deactivate user input window. Inactivate user input window before using hot keys.

NOTE: It is very important to inactivate the user input window when you intend to use the hot key menu on the numeric keys.

System Information

- Date and Time
- Positioning Information (Longitude and Latitude). It is available only when a GPS antenna is connected. Frequency reference is automatically set to GPS in the System menu when a GPS antenna is connected.
- Frequency Reference Indicator: INT for internal and EXT for external. The EXT icon is green when an external reference is locked or red when the external reference is not locked. When a GPS antenna is connected, this space will be blank.
- GPS Indicator: Color of the GPS icon changes among green, yellow and gray depending on locking status.
- USB Indicator
- DC Input Power Indicator
- Battery Indicator

Pass/Fail Indicator

CONNECTING A CABLE

Direct Connection

Connect the **Spectrum Analyzer RF In 50 Ω** port of the JD740A series and the PA output port of BTS.

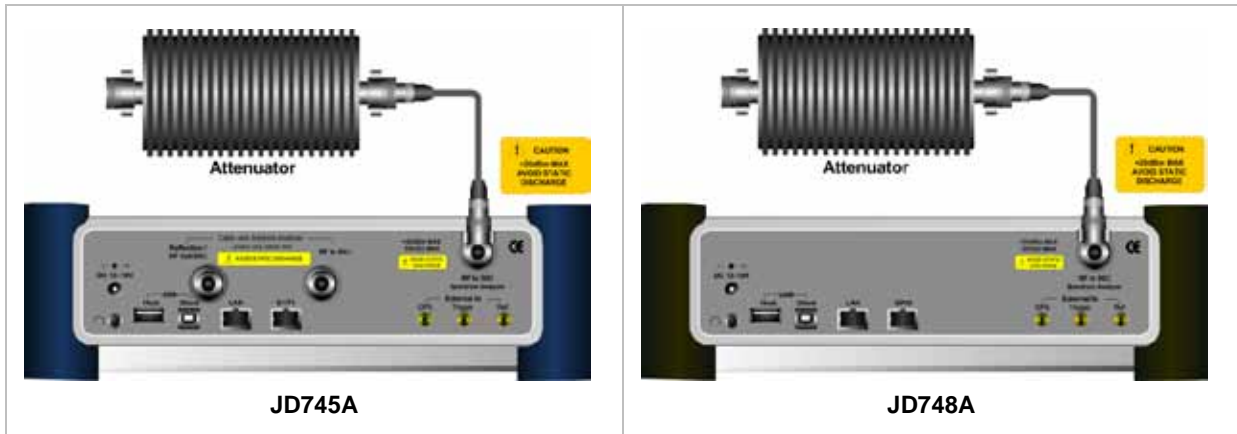

Indirect Connection

Connect the **Spectrum Analyzer RF In 50 Ω** port of the JD740A series and the monitor port of BTS.

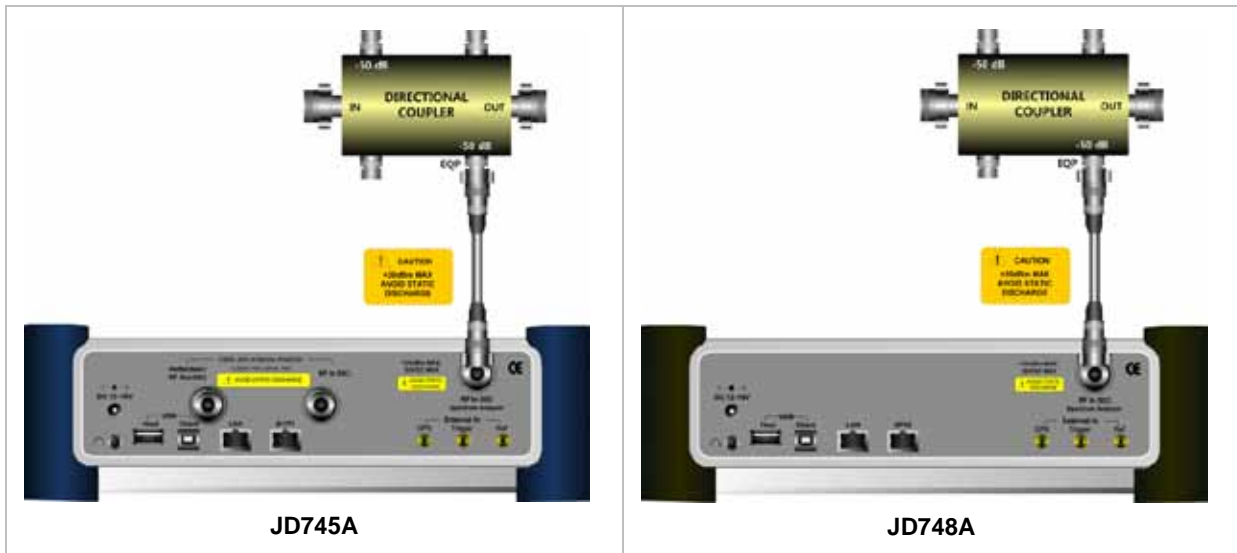

The maximum power for the **Spectrum Analyzer RF In 50 Ω** port is +20 dBm (0.1 Watt). If the input signal level to be measured is greater than +20 dBm, use a **High Power Attenuator** to prevent damage when you directly connect the signal to the instrument. Or connect a signal from the coupling port of a directional coupler.

Over The Air (OTA)

Connect an Omni/directional RF antenna to the **Spectrum Analyzer RF In 50 Ω** port of the JD740A series and then a GPS antenna to the **GPS** port of the JD740A series.

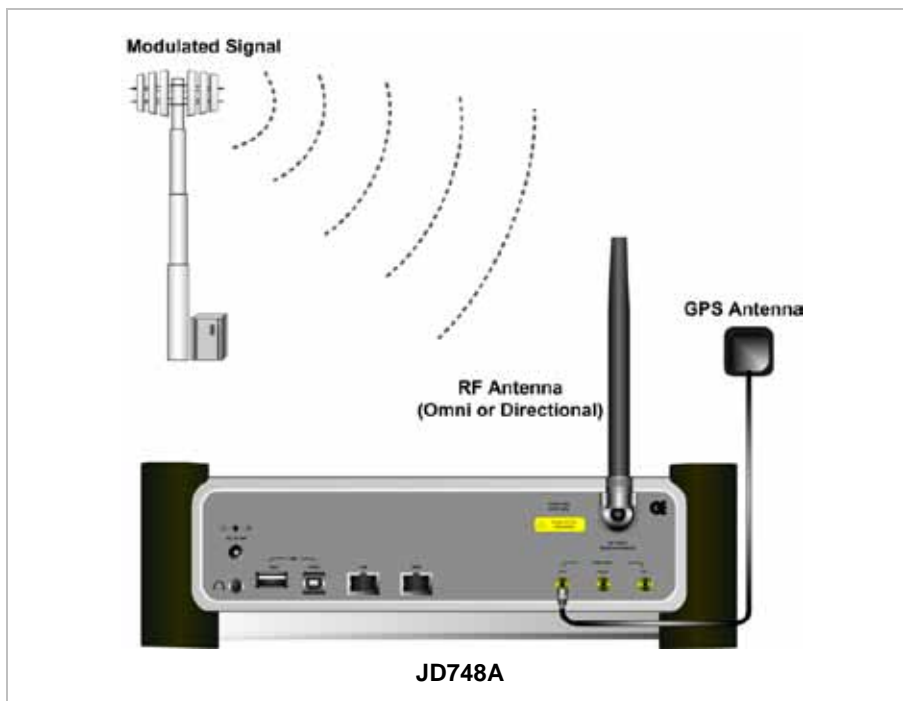
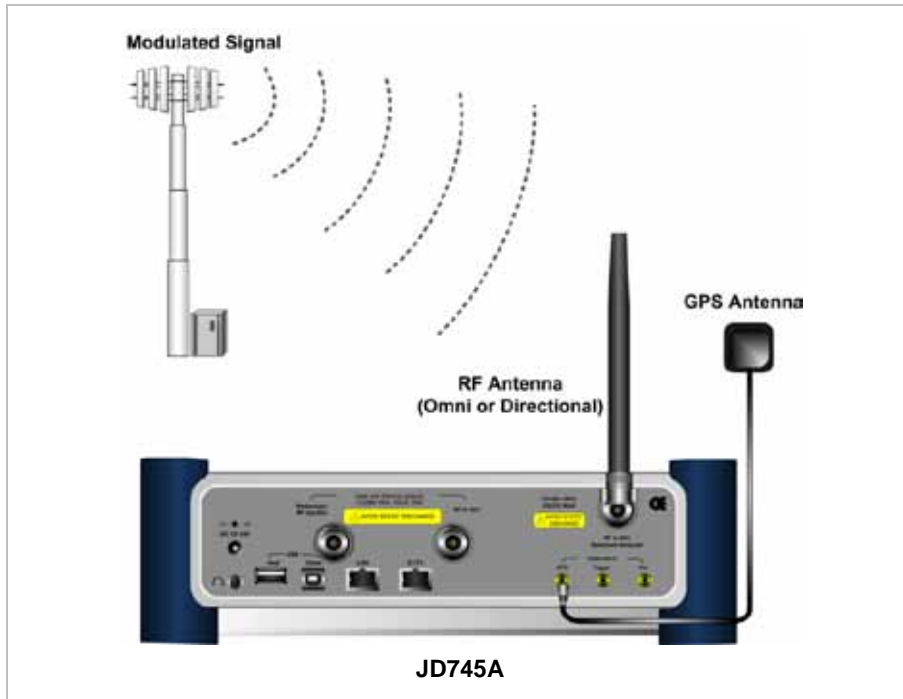

If the input signal level to be measured is less than 0 dBm, set 0 dB attenuation or turn on the preamp to have better dynamic range for the OTA testing.

SPECTRUM ANALYSIS MEASUREMENT

Setting Mode

| Step | Description |
|--|---|
| 1. Connect the cable | Connect a cable directly or indirectly as shown in the section Connecting a Cable on page 7 of this chapter. |
| 2. Select the mode MODE [Signal Analyzer] [EV-DO] [Spectrum] | Press the MODE hard key. Press the Signal Analyzer soft key. Press the EV-DO soft key. Press the Spectrum soft key. (Spectrum mode is set by default.) |

Setting Frequency

| Step | Description |
|--|--|
| 1. Set the frequency FREQ/DIST [Unit] <Freq> or <Channel> | Press the FREQ/DIST hard key. Press the Unit soft key. Toggle this key between Freq and Channel . A set of Freq/Dist screen menu changes accordingly. |
| <i>When Freq is selected:</i> [Center Frequency] Enter a value [GHz], [MHz], [kHz], or [Hz] | Press the Center Frequency soft key. Use the numeric keys, the rotary knob, or the arrow keys. When using the numeric keys, the input is completed by selecting one of the unit soft keys. |
| <i>When Channel is selected:</i> [Channel Standard] Select a channel standard | Press the Channel Standard soft key. Press the arrow keys, rotate the knob, or press the Page Up and Page Down soft keys to highlight a frequency band to select. |
| [Select] or ENTER | Press the Select soft key or the ENTER hard key. |
| [Channel Number] Enter a value [Forward] | Press the Channel Number soft key. Use the numeric keys to input value and press the Forward soft key to complete the input. The instrument automatically displays its corresponding center frequency value for the |

channel number.

FREQ/DIST 

- n **UNIT:** Determines the way how to set the frequency band either with standard band or custom frequency band. Toggling this key between **Freq** and **Channel** changes a set of Freq/Dist screen menu automatically.
- n **CENTER FREQUENCY:** Changes the center frequency setting. Use the rotary knob or the arrow keys. Or use the numeric keys to input a certain value and press one of the unit soft keys to complete the input.
- n **FREQUENCY STEP:** Defines the amount of frequency to be increased or decreased when using the rotary knob or the arrow keys to change the **Center Frequency**. This frequency step size can be entered by using numeric keys and the unit soft keys.
- n **CHANNEL NUMBER:** Enters a channel number. The instrument automatically displays its corresponding center frequency value for the channel number.
- n **CHANNEL STEP:** Defines the amount of channel to be increased or decreased when using the rotary knob or the arrow keys to change the **Channel Number**. This channel step size can be entered by using numeric keys and the **Enter** soft key.
- n **CHANNEL STANDARD:** When the channel standard is selected from the list, the center frequency information on the display screen will be mapped accordingly to the selected channel standard. The channel standards available in the instrument are listed in the Appendix C – Band, Frequency & Channel Standard.

Setting Amplitude

| Step | Description |
|--|--|
| 1. Set the reference/attenuation level AMP/SCALE [Auto Scale] or [Reference Level] Enter a reference level value [dBm] or ENTER | Press the AMP/SCALE hard key. Press the Auto Scale soft key to automatically set optimum levels of reference and attenuation. Press the Reference Level soft key to set manually. Use the numeric keys or the rotary knob that changes in a 10 dB step. Press the dBm soft key or the ENTER hard key. |

| | |
|----------------------------|---|
| [Attenuation] | Press the Attenuation soft key. The Auto mode is set by default. This key toggles between the Auto and Manual . |
| <Manual> | Press the Attenuation soft key to highlight the Manual mode and change the attenuation value to optimize S/N. |
| Enter an attenuation value | Use the numeric keys or the rotary knob that changes in a 5 dB step. The attenuation setting range is 0 to 50 dB. |

AMP/SCALE



- n **AUTO SCALE:** The instrument can automatically set the scale to the minimum and maximum values on the Y-axis of the graph for optimum display of the traces measured. Each time the **Auto Scale** is selected, the top and bottom scales are set to the minimum and maximum values with margin on the Y-axis of the display screen and attenuation is set to its optimum value.
- n **REFERENCE LEVEL:** Sets the maximum Y-axis.
- n **SCALE/DIV:** Is used only for the Spectrum measurement screen. It represents the value of one division on the horizontal scale. The default value is 10 dB per division and the Y-Scale is set to 100 dB. Selecting the **Scale/Div** soft key enables to set the value to 1 dB per division with the numeric keys or the rotary knob.
- n **ATTENUATION**
 - Y **AUTO:** Input attenuator's value is automatically set depending on the reference level. This is the default operation mode, so it is recommended to use this mode unless a special measurement condition is needed.
 - Y **MANUAL:** Sets the attenuator's value for the **Spectrum Analyzer RF In 50 Ω** port.
- n **PREAMP:** Turns on or off the internal pre-amplifier. Preamp results in a correction being applied to compensate for the gain of the preamp so that amplitude readings show the value at the input connector. This soft key toggles between the **On** and **Off**. When it is set to On, the allowable attenuation input range is from 0 dB to 10 dB in a multiple of 5. If the attenuation value is manually set greater than 10 dB, the instrument will automatically turn off the pre-amplifier to display low level signal properly on the screen.
- n **UNITS:** Sets the scale unit on the display among **dBm**, **dBV**, **dBmV**, **dBuV**, **V**, and **W**.
- n **EXTERNAL OFFSET:** Sets an external offset value. An offset consists of a cable loss and a user offset and the measurement result shows the value reflecting both offset values. When the external offset value is set at 40 dB in the Spectrum mode, the measurement result compensates 40 dB at both the Spectrum Analyzer and Signal Analyzer modes.

Setting Averaging

BW/AVG 

- n **AVERAGE:** Sets the number of measurements to be averaged for the trace presentation. A maximum of 100 times of averaging can be set.

| STEP | Description |
|---|--|
| 1. Set the averaging BW/AVG [Average] | Press the BW/AVG hard key. Press the Average soft key. |
| 2. Enter number of averaging to set | Use the numeric keys and input a number between 1 and 100. When the averaging reaches to the number set here, a new measurement value replaces the earliest measurement value in sequence. |
| 3. [Enter] or ENTER | Press the Enter soft key or the ENTER hard key. |

Setting Sweep Mode

SWEEP 

This hot key is used to set the sweep parameters. The user input window must be inactive first to get the Sweep hot key function other than the number input.

- n **SWEEP MODE:** Sets the sweep method. Toggle between **Continue** and **Single**.

| Step | Description |
|--|---|
| 1. Set the sweep mode SWEEP [Sweep Mode] | Press the SWEEP hot key. Press the Sweep Mode soft key. Toggle between Continue and Single . |

Setting Trigger Source

TRIGGER 

This hot key is used to select the trigger source among **Internal**, **External**, and **GPS**. The user input window must be inactive first to get the Trigger hot key function other than the number input.

Setting External Clock

To enhance the reliability of modulation analysis measurements the JD740A series must be synchronized with the Base Station. When an external clock is not supplied, the JD740A series works with a built-in internal high-accuracy time base. In this case, some measurement results may exhibit inaccurate values. Therefore, it is highly recommended to use the same reference clock as signal source. Trigger mode can be changed by using the **TRIGGER** hot key.

EXTERNAL CLOCK OPERATING STANDARDS

| Clock | Type | Reference | Port | Switching Standard |
|--------------------|----------|--------------------|---------------|--|
| External Reference | Internal | Internal 10 MHz | | Default |
| | External | External Ref Clock | Ext Ref (SMA) | Manual switching (Input signal level >-3 dBm) |
| | GPS | GPS Clock | GPS (SMA) | Automatic switching (GPS signal received) |
| Trigger | Internal | Internal Trigger | | Default |
| | External | External Trigger | Trigger (SMA) | Manual switching |
| | GPS | GPS | GPS (SMA) | Manual switching |

CONNECTION

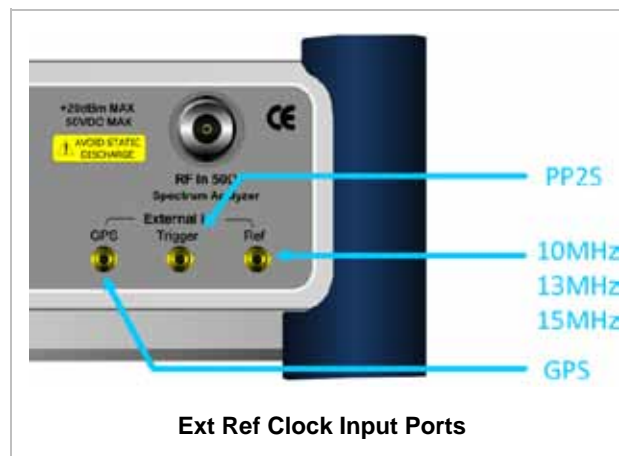

ENABLING EXTERNAL REFERENCE

| Step | Description |
|---|---|
| 1. Connect an external reference | Connect one of the external references or a GPS antenna to the JD740A series. |
| 2. Change reference clock SYSTEM | Press the SYSTEM hot key. |

| | |
|--|---|
| <p>[Frequency Reference]</p> <p>[External 10 MHz], [External 13 MHz], [External 15 MHz] or [GPS]</p> | <p>Press the Frequency Reference soft key to select one of the external reference clocks or GPS.</p> <p>Press one of the soft keys to choose among External 10 MHz, External 13 MHz, External 15 MHz, and GPS.</p> |
|--|---|

EXTERNAL REFERENCE INDICATOR INFORMATION

Each indicator tells different locking status according to a connection. When a GPS antenna is connected, longitude and latitude information will be displayed on the screen.

| Type | Indicator | Description |
|----------|--|----------------------------------|
| Internal |  (Green) | Locked |
| External |  (Green) | Locked |
| |  (Red) | Unlocked |
| GPS |  (Green) | Locked |
| |  (Yellow) | Locking in progress |
| |  (Gray) | Unable to lock or antenna failed |

Setting Trace and Display

TRACE/DISPLAY

- n **SELECT TRACE:** Selects an active trace from T1 to T6. Trace numbers are assigned to each captured trace or loaded trace. Pressing one of the 6 trace number soft keys sets the selected trace number as the active trace on the display screen.
- n **CLEAR WRITE:** Clears the selected trace and writes or assigns the current trace.
- n **MAX HOLD:** Sets the active trace to display the maximum response of the input signal. Active trace compares newly acquired data with the trace shown on the screen and displays the bigger trace on the display screen.
- n **MIN HOLD:** Sets the active trace to display the minimum response of the input signal. Active trace compares newly acquired data with the trace shown on the screen and displays the smaller trace on the display screen.
- n **CAPTURE:** Captures a current trace on the display screen with the selected trace number.
- n **TRACE VIEW:** Displays the trace of the selected trace number on the display screen or hides it from the display screen. Press the **Select Trace** soft key to select a trace number and then press

the **Trace View** soft key to toggle between the **Off** to hide and **On** to restore a hidden trace.

- n **TRACE CLEAR ALL:** Deletes all traces from the instrument and initializes the trace settings.

Measurement Procedure

| Step | Description |
|--|--|
| 1. Select the measurement mode MEASURE [Spectrum] | Press the MEASURE hot key. Press the Spectrum soft key. |

EV-DO Spectrum Measurement Procedure

Measurement Example

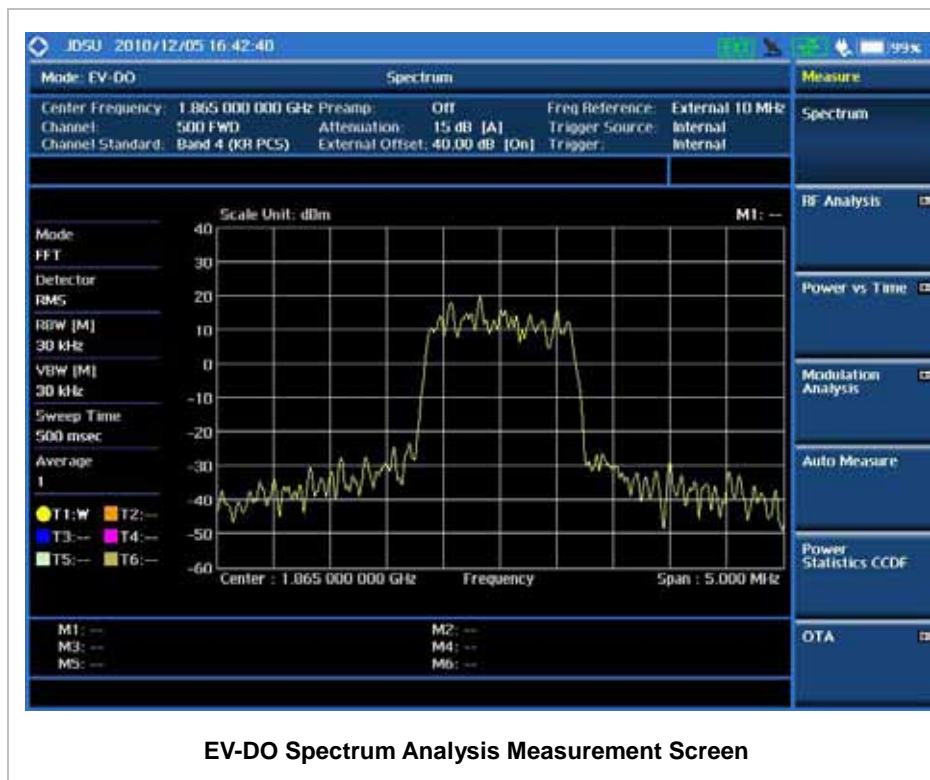

EV-DO Spectrum Analysis Measurement Screen

RF ANALYSIS MEASUREMENTS

RF Analysis in EV-DO Signal Analyzer provides single-button measurements for the following measurements.

- n Channel Power
- n Occupied Bandwidth
- n Spectrum Emission Mask
- n Adjacent Channel Power Ratio (ACPR)
- n Multi-ACPR
- n Spurious Emissions

Setting Mode

| Step | Description |
|--|---|
| 1. Connect the cable | Connect a cable directly or indirectly as shown in the section Connecting a Cable on page 7 of this chapter. |
| 2. Select the mode MODE [Signal Analyzer] [EV-DO] [RF Analysis] [Channel Power], [Occupied BW], [Spectrum Emission Mask], [ACPR], [Multi-ACPR], or [Spurious Emissions] | Press the MODE hard key. Press the Signal Analyzer soft key. Press the EV-DO soft key. Press the RF Analysis soft key. Press one of the measurement mode soft keys to select. |

Setting Frequency

This setting is not used in the Multi-ACPR mode and the Spurious Emissions mode.

| Step | Description |
|---|--|
| 1. Set the frequency FREQ/DIST [Unit] <Freq> or <Channel> | Press the FREQ/DIST hard key. Press the Unit soft key. Toggle this key between Freq and Channel . A set of Freq/Dist screen menu changes accordingly. |
| <u>When Freq is selected:</u> [Center Frequency] Enter a value | Press the Center Frequency soft key. Use the numeric keys, the rotary knob, or the arrow keys. |

| | |
|---|--|
| <p>[GHz], [MHz], [kHz], or [Hz]</p> | <p>When using the numeric keys, the input is completed by selecting one of the unit soft keys.</p> |
| <p><i>When Channel is selected:</i></p> | |
| <p>[Channel Standard] Select a channel standard</p> | <p>Press the Channel Standard soft key. Press the arrow keys, rotate the knob, or press the Page Up and Page Down soft keys to highlight a frequency band to select.</p> |
| <p>[Select] or ENTER</p> | <p>Press the Select soft key or the ENTER hard key.</p> |
| <p>[Channel Number] Enter a value [Forward]</p> | <p>Press the Channel Number soft key. Use the numeric keys to input value and press the Forward soft key to complete the input. The instrument automatically displays its corresponding center frequency value for the channel number.</p> |

FREQ/DIST



- n **UNIT:** Determines the way how to set the frequency band either with standard band or custom frequency band. Toggling this key between **Freq** and **Channel** changes a set of Freq/Dist screen menu automatically.
- n **CENTER FREQUENCY:** Changes the center frequency setting. Use the rotary knob or the arrow keys. Or use the numeric keys to input a certain value and press one of the unit soft keys to complete the input.
- n **FREQUENCY STEP:** Defines the amount of frequency to be increased or decreased when using the rotary knob or the arrow keys to change the **Center Frequency**. This frequency step size can be entered by using numeric keys and the unit soft keys.
- n **CHANNEL NUMBER:** Enters a channel number. The instrument automatically displays its corresponding center frequency value for the channel number.
- n **CHANNEL STEP:** Defines the amount of channel to be increased or decreased when using the rotary knob or the arrow keys to change the **Channel Number**. This channel step size can be entered by using numeric keys and the **Enter** soft key.
- n **CHANNEL STANDARD:** When the channel standard is selected from the list, the center frequency information on the display screen will be mapped accordingly to the selected channel standard. The channel standards available in the instrument are listed in the Appendix C – Band, Frequency & Channel Standard.

Setting Amplitude

| Step | Description |
|--|---|
| <p>1. Set the reference/attenuation level</p> <p>AMP/SCALE</p> <p>[Auto Scale]</p> <p>or</p> <p>[Reference Level] Enter a reference level value</p> <p>[dBm] or ENTER</p> <p>[Attenuation]</p> <p><Manual></p> <p>Enter an attenuation value</p> | <p>Press the AMP/SCALE hard key.</p> <p>Press the Auto Scale soft key to automatically set optimum levels of reference and attenuation.</p> <p>Press the Reference Level soft key to set manually.</p> <p>Use the numeric keys or the rotary knob that changes in a 10 dB step.</p> <p>Press the dBm soft key or the ENTER hard key.</p> <p>Press the Attenuation soft key. The Auto mode is set by default. This key toggles between the Auto and Manual.</p> <p>Press the Attenuation soft key to highlight the Manual mode and change the attenuation value to optimize S/N.</p> <p>Use the numeric keys or the rotary knob that changes in a 5 dB step. The attenuation setting range is 0 to 50 dB.</p> |

AMP/SCALE 

- n **AUTO SCALE:** The instrument can automatically set the scale to the minimum and maximum values on the Y-axis of the graph for optimum display of the traces measured. Each time the **Auto Scale** is selected, the top and bottom scales are set to the minimum and maximum values with margin on the Y-axis of the display screen.
- n **REFERENCE LEVEL:** Sets the maximum Y-axis.
- n **SCALE/DIV:** Is used only for the Spectrum measurement screen. It represents the value of one division on the horizontal scale. The default value is 10 dB per division and the Y-Scale is set to 100 dB. Selecting the **Scale/Div** soft key enables to set the value to 1 dB per division with the numeric keys or the rotary knob.
- n **ATTENUATION**
 - Y **AUTO:** Input attenuator's value is automatically set depending on the reference level. This is the default operation mode, so it is recommended to use this mode unless a special measurement condition is needed.
 - Y **MANUAL:** Sets the attenuator's value for the **Spectrum Analyzer RF In 50 Ω** port.
- n **PREAMP:** Turns on or off the internal pre-amplifier. Preamp results in a correction being applied to compensate for the gain of the preamp so that amplitude readings show the value at the input

connector. This soft key toggles between the **On** and **Off**. When it is set to **On**, the allowable attenuation input range is from 0 dB to 10 dB in a multiple of 5. If the attenuation value is manually set greater than 10 dB, the instrument will automatically turn off the pre-amplifier to display low level signal properly on the screen.

- n **UNITS:** Sets the scale unit on the display among **dBm**, **dBV**, **dBmV**, **dBuV**, **V**, and **W**.
- n **EXTERNAL OFFSET:** Sets an external offset value. An offset consists of a cable loss and a user offset and the measurement result shows the value reflecting both offset values. When the external offset value is set at 40 dB in the Spectrum mode, the measurement result compensates 40 dB at both the Spectrum Analyzer and Signal Analyzer modes.

Setting Averaging



- n **AVERAGE:** Sets the number of measurements to be averaged for the trace presentation. A maximum of 100 times of averaging can be set. *This setting is not used in the Spurious Emissions mode.*

| Step | Description |
|---|--|
| 1. Set the averaging BW/AVG [Average] | Press the BW/AVG hard key. Press the Average soft key. |
| 2. Enter number of averaging to set | Use the numeric keys and input a number between 1 and 100. When the averaging reaches to the number set here, a new measurement value replaces the earliest measurement value in sequence. |
| 3. [Enter] or ENTER | Press the Enter soft key or the ENTER hard key. |

Setting Sweep Mode



This hot key is used to set the sweep parameters. The user input window must be inactive first to get the Sweep hot key function other than the number input.

- n **SWEEP MODE:** Sets the sweep method. Toggle between **Continue** and **Single**.

| Step | Description |
|---|---|
| 1. Set the sweep mode SWEEP [Sweep Mode] | Press the SWEEP hot key. Press the Sweep Mode soft key. Toggle between Continue and Single . |

Setting Trigger Source



This hot key is used to select the trigger source among **Internal**, **External**, and **GPS**. The user input window must be inactive first to get the Trigger hot key function other than the number input.

Setting External Clock

To enhance the reliability of modulation analysis measurements the JD740A series must be synchronized with the Base Station. When an external clock is not supplied, the JD740A series works with a built-in internal high-accuracy time base. In this case, some measurement results may exhibit inaccurate values. Therefore, it is highly recommended to use the same reference clock as signal source. Trigger mode can be changed by using the **TRIGGER** hot key.

EXTERNAL CLOCK OPERATING STANDARDS

| Clock | Type | Reference | Port | Switching Standard |
|--------------------|----------|--------------------|---------------|--|
| External Reference | Internal | Internal 10 MHz | | Default |
| | External | External Ref Clock | Ext Ref (SMA) | Manual switching (Input signal level >-3 dBm) |
| | GPS | GPS Clock | GPS (SMA) | Automatic switching (GPS signal received) |
| Trigger | Internal | Internal Trigger | | Default |
| | External | External Trigger | Trigger (SMA) | Manual switching |
| | GPS | GPS | GPS (SMA) | Manual switching |

CONNECTION

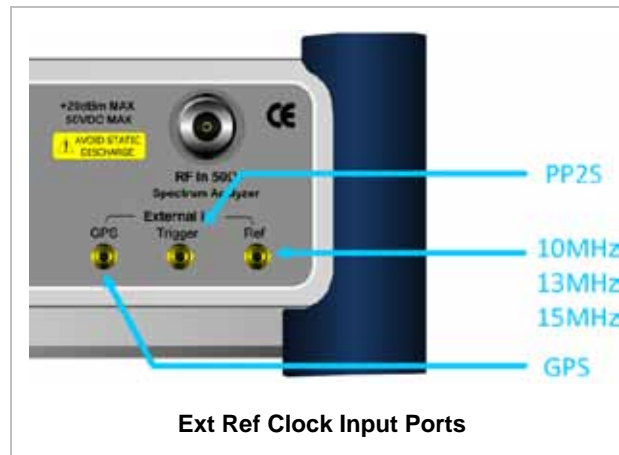

ENABLING EXTERNAL REFERENCE

| Step | Description |
|---|--|
| 1. Connect an external reference | Connect one of the external references or a GPS antenna to the JD740A series. |
| 2. Change reference clock SYSTEM [Frequency Reference] [External 10 MHz], [External 13 MHz], [External 15 MHz] or [GPS] | Press the SYSTEM hot key. Press the Frequency Reference soft key to select one of the external reference clocks or GPS. Press one of the soft keys to choose among External 10 MHz , External 13 MHz , External 15 MHz , and GPS . |

EXTERNAL REFERENCE INDICATOR INFORMATION

Each indicator tells different locking status according to a connection. When a GPS antenna is connected, longitude and latitude information will be displayed on the screen.

| Type | Indicator | Description |
|----------|--|----------------------------------|
| Internal |  (Green) | Locked |
| External |  (Green) | Locked |
| |  (Red) | Unlocked |
| GPS |  (Green) | Locked |
| |  (Yellow) | Locking in progress |
| |  (Gray) | Unable to lock or antenna failed |

CHANNEL POWER

The Channel Power measurement is a common test used in the wireless industry to measure the total transmitted power of a radio within a defined frequency channel. It acquires a number of points representing the input signal in the time domain, transforms this information into the frequency domain using Fast Fourier Transform (FFT) and then calculates the channel power. The effective resolution bandwidth of the frequency domain trace is proportional to the number of points acquired for the FFT.

The channel power measurement identifies the total RF power, power spectral density (PSD) and peak to average ratio (PAR) of the signal in the EV-DO channel bandwidth (1.23 MHz).

Measurement Procedure

| Step | Description |
|---|---|
| 1. Set the measurement mode MEASURE [RF Analysis] [Channel Power] | Press the MEASURE hot key. Press the RF Analysis soft key. Press the Channel Power soft key. |

EV-DO Channel Power Measurement Procedure

Setting Limit



This hot key is used to set the threshold value for the limit line on the display screen. It turns on or off the limit or band limit settings of the measurement for pass/fail indication. The user input window must be inactive first to get the Limit hot key function other than the number input.

| Step | Description |
|--|--|
| 1. Select the limit LIMIT [RF Test Limits] [Channel Power] [Test Limits] <On> or <Off> [High Limit] Enter a value [dBm] or ENTER | Press the LIMIT hot key. Press the RF Test Limits soft key. Press the Channel Power soft key. Press the Test Limits soft key to toggle between On and Off and select one. Press the High Limit soft key to set the upper limit of the Pass/Fail criteria. Use the numeric keys to input value. Press the unit soft key or the ENTER hard key. |

| | |
|---|--|
| <p>[Low Limit] Enter a value [dBm] or ENTER</p> | <p>Press the Low Limit soft key to set the lower limit of the Pass/Fail criteria. Use the numeric keys to input value. Press the unit soft key or the ENTER hard key.</p> |
| <p>2. Enable beep LIMIT [Beep] <On> or <Off></p> | <p>Press the LIMIT hot key. Press the Beep soft key to toggle between On and Off and select one. This will make audible alarm if the measurement result goes beyond the limit.</p> |

- n **TEST LIMITS:** Enables or disables Pass/Fail results on the display screen. Toggle the **Test Limits** soft key to set it to **On** or **Off**.
- n **HIGH LIMIT:** Sets the upper limit of the Pass/Fail criteria. Use the numeric keys to enter a threshold or limit value and press the **dBm** unit soft key or the **ENTER** hard key.
- n **LOW LIMIT:** Sets the lower limit of the Pass/Fail criteria. Use the numeric keys to enter a threshold or limit value and press the **dBm** unit soft key or the **ENTER** hard key.

Measurement Example

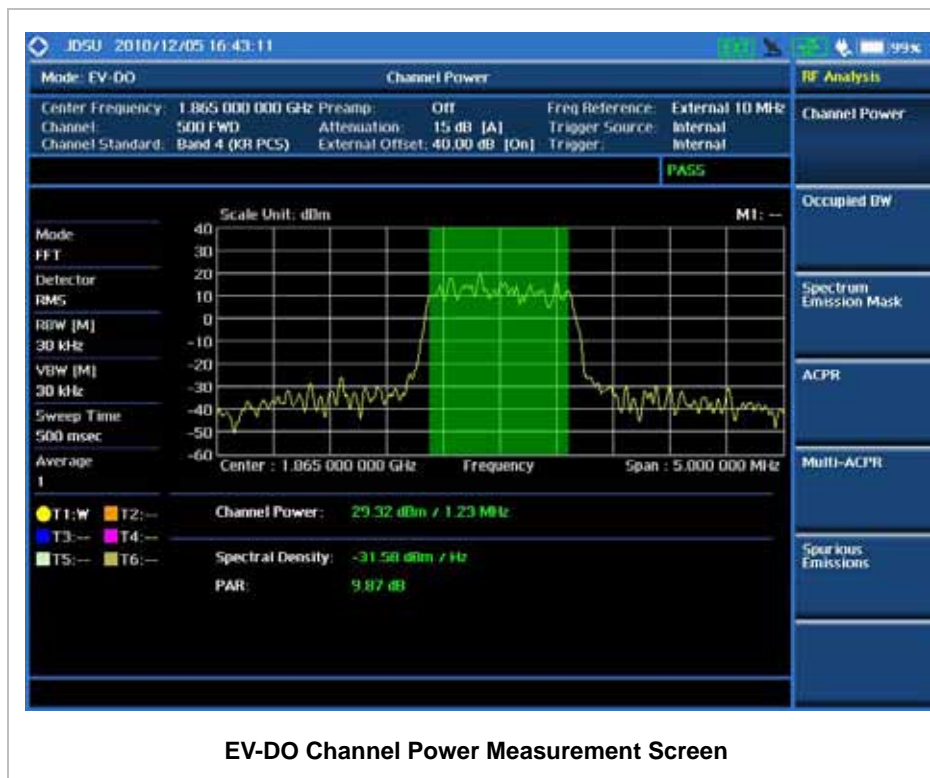

EV-DO Channel Power Measurement Screen

OCCUPIED BANDWIDTH

The Occupied Bandwidth measures the spectrum shape of the carrier. It is defined as the bandwidth which includes 99% of the transmitted power among total transmitted power.

Measurement Procedure

| Step | Description |
|---|---|
| 1. Set the measurement mode MEASURE [RF Analysis] [Occupied BW] | Press the MEASURE hot key. Press the RF Analysis soft key. Press the Occupied BW soft key. |

EV-DO Occupied BW Measurement Procedure

Setting Limit



This hot key is used to set the threshold value for the limit line on the display screen. It turns on or off the limit or band limit settings of the measurement for pass/fail indication. The user input window must be inactive first to get the Limit hot key function other than the number input.

| Step | Description |
|---|--|
| 1. Select the limit LIMIT [RF Test Limits] [Occupied BW] [Test Limit] <On> or <Off> [High Limit] Enter a value [MHz], [kHz], or [Hz] | Press the LIMIT hot key. Press the RF Test Limits soft key. Press the Occupied BW soft key. Press the Test Limit soft key to toggle between On and Off and select one. Press the High Limit soft key to set the upper limit of the Pass/Fail criteria. Use the numeric keys to input value. Press the unit soft key to select. |
| 2. Enable beep LIMIT [Beep] <On> or <Off> | Press the LIMIT hot key. Press the Beep soft key to toggle between On and Off and select one. This will make audible alarm if the measurement result goes beyond the limit. |

n **TEST LIMIT:** Enables or disables Pass/Fail results on the display screen. Toggle the **Test Limit**

soft key to set it to **On** or **Off**.

- n **HIGH LIMIT:** Sets the upper limit of the Pass/Fail criteria. Use the numeric keys to enter a threshold or limit value and press one of the unit soft keys to complete the input.

Measurement Example



SPECTRUM EMISSION MASK (SEM)

The Spectrum Emission Mask (SEM) measurement required by 3GPP2 specifications encompasses different power limits and different measurement bandwidths (resolution bandwidths) at various frequency offsets. It may be expressed as a ratio of power spectral densities between the carrier and the specified offset frequency band. It provides useful figures-of-merit for the spectral re-growth and emissions produced by components and circuit blocks, without the rigor of performing a full SEM measurement.

The SEM measures spurious signal levels in up to five pairs of offset or region frequencies and relates them to the carrier power.

Measurement Procedure

| Step | Description |
|--|--|
| 1. Set the measurement mode MEASURE [RF Analysis] [Spectrum Emission Mask] | Press the MEASURE hot key. Press the RF Analysis soft key. Press the Spectrum Emission Mask soft key. |

EV-DO Spectrum Emission Mask Measurement Procedure

Setting Limit



This hot key is used to set the threshold value for the limit line on the display screen. It turns on or off the limit or band limit settings of the measurement for pass/fail indication. The user input window must be inactive first to get the Limit hot key function other than the number input.

| Step | Description |
|--|--|
| 1. Select the limit LIMIT [RF Test Limits] [Spectrum Emission Mask] [Test Limit] <On> or <Off> | Press the LIMIT hot key. Press the RF Test Limits soft key. Press the Spectrum Emission Mask soft key. Press the Test Limit soft key to toggle between On and Off and select one. |
| 2. Enable beep LIMIT [Beep] <On> or <Off> | Press the LIMIT hot key. Press the Beep soft key to toggle between On and Off and select one. This will make audible alarm if the measurement result goes beyond the limit. |

- n **TEST LIMIT:** Enables or disables Pass/Fail results on the display screen. Toggle the **Test Limit** soft key to set it to **On** or **Off**.

Measurement Example



EV-DO Spectrum Emission Mask Measurement Screen

ACPR

The Adjacent Channel Power Ratio (ACPR) is defined as the ratio of the average power in the adjacent frequency channel (or offset) to the average power in the transmitted frequency channel. It may be expressed as the ratio of the integrated signal power in the adjacent channel to the integrated signal power in the main channel.

Measurement Procedure

| Step | Description |
|--|--|
| 1. Set the measurement mode MEASURE [RF Analysis] [ACPR] | Press the MEASURE hot key. Press the RF Analysis soft key. Press the ACPR soft key. |

EV-DO ACPR Measurement Procedure

Setting Limit



This hot key is used to set the threshold value for the limit line on the display screen. It turns on or off the limit or band limit settings of the measurement for pass/fail indication. The user input window must be inactive first to get the Limit hot key function other than the number input.

| Step | Description |
|--|--|
| 1. Select the limit LIMIT [RF Test Limits] [ACPR] [Test Limit] <On> or <Off> | Press the LIMIT hot key. Press the RF Test Limits soft key. Press the ACPR soft key. Press the Test Limit soft key to toggle between On and Off and select one. |
| 2. Enable beep LIMIT [Beep] <On> or <Off> | Press the LIMIT hot key. Press the Beep soft key to toggle between On and Off and select one. This will make audible alarm if the measurement result goes beyond the limit. |

- n **TEST LIMIT:** Enables or disables Pass/Fail results on the display screen. Toggle the **Test Limit** soft key to set it to **On** or **Off**.

Measurement Example

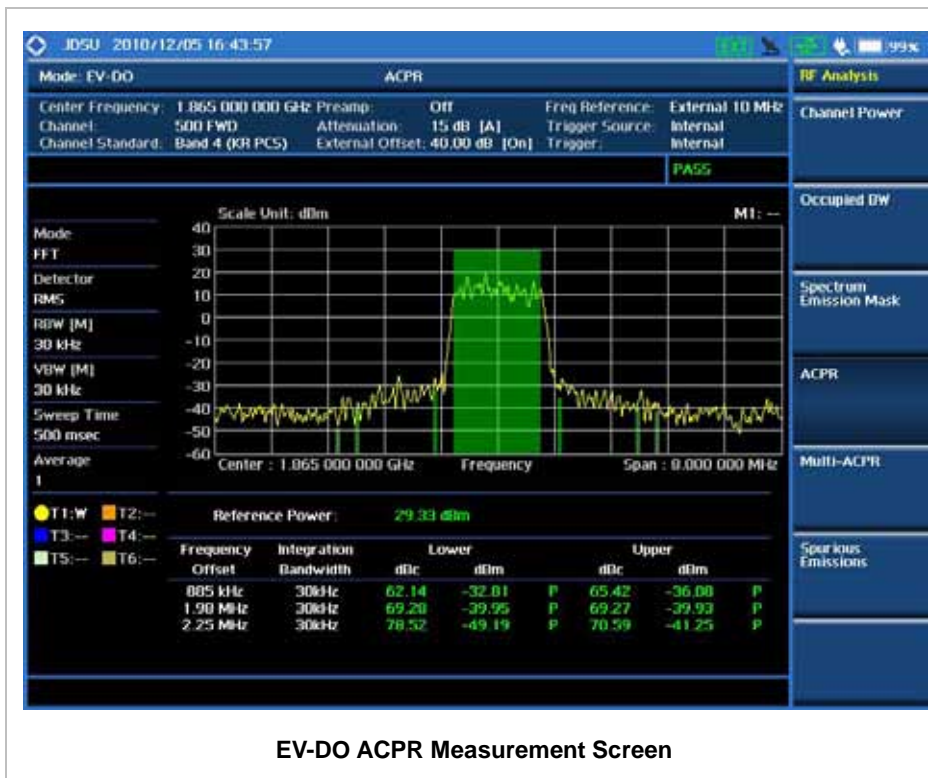

EV-DO ACPR Measurement Screen

MULTI-ACPR

The Multi-ACPR measurement is used to perform multi-channel ACPR measurements with as many channels as possible. It helps the user to measure ACPR in multi-channel transmitting Base Station environment.

Measurement Procedure

| Step | Description |
|--|--|
| <p>1. Set the measurement mode</p> <p>MEASURE</p> <p>[RF Analysis]</p> <p>[Multi-ACPR]</p> | <p>Press the MEASURE hot key.</p> <p>Press the RF Analysis soft key.</p> <p>Press the Multi-ACPR soft key.</p> |
| <p>2. Set the measurement parameters</p> <p>MEASURE SETUP</p> <p>[Unit]</p> <p><Freq> or <Channel></p> <p><u>When Freq is selected:</u></p> <p>[Lowest Frequency]</p> <p>Enter a value</p> <p>[GHz], [MHz], [kHz], or [Hz]</p> <p>[Highest Frequency]</p> <p>Enter a value</p> <p>[GHz], [MHz], [kHz], or [Hz]</p> <p><u>When Channel is selected:</u></p> <p>[Channel Standard]</p> <p>Select a channel standard</p> <p>[Select] or ENTER</p> <p>[Lowest Channel]</p> <p>Enter a value</p> <p>[Forward]</p> <p>[Highest Channel]</p> <p>Enter a value</p> <p>[Forward]</p> | <p>Press the MEASURE SETUP hot key.</p> <p>Press the Unit soft key. Toggle this key between Freq and Channel. A set of Freq/Dist screen menu changes accordingly.</p> <p>Press the Lowest Frequency soft key.</p> <p>Use the numeric keys to input value.</p> <p>Press one of the unit soft keys to select.</p> <p>Press the Highest Frequency soft key.</p> <p>Use the numeric keys to input value.</p> <p>Press one of the unit soft keys to select.</p> <p>Press the Channel Standard soft key.</p> <p>Press the arrow keys, rotate the knob, or press the Page Up and Page Down soft keys to highlight a frequency band to select.</p> <p>Press the Select soft key or the ENTER hard key.</p> <p>Press the Lowest Channel soft key.</p> <p>Use the numeric keys to input value.</p> <p>Press the Forward soft key.</p> <p>Press the Highest Channel soft key.</p> <p>Use the numeric keys to input value.</p> <p>Press the Forward soft key.</p> |

EV-DO Multi-ACPR Measurement Procedure

MEASURE SETUP



- n **UNIT:** Determines the way how to set the frequency band either with standard band or custom frequency band. Toggling this key between **Freq** and **Channel** changes a set of Freq/Dist screen menu automatically.
- n **LOWEST FREQUENCY:** Sets the center frequency of the far left end on the display. Use the numeric keys to enter a value and press one of the unit soft keys to complete the input.
- n **HIGHEST FREQUENCY:** Sets the center frequency of the far right end on the display. Use the numeric keys to enter a value and press one of the unit soft keys to complete the input.
- n **LOWEST CHANNEL:** Sets the channel number of the far left end on the display.
- n **HIGHEST CHANNEL:** Sets the channel number of the far right end on the display.
- n **CHANNEL STANDARD:** When the channel standard is selected from the list, the center frequency information on the display screen will be mapped accordingly to the selected channel standard. The channel standards available in the instrument are listed in the Appendix C – Band, Frequency & Channel Standard.

Setting Limit

LIMIT



This hot key is used to set the threshold value for the limit line on the display screen. It turns on or off the limit or band limit settings of the measurement for pass/fail indication. The user input window must be inactive first to get the Limit hot key function other than the number input.

| Step | Description |
|--|--|
| 1. Select the limit LIMIT [RF Test Limits] [Multi-ACPR] [Test Limit] <On> or <Off> | Press the LIMIT hot key. Press the RF Test Limits soft key. Press the Multi-ACPR soft key. Press the Test Limit soft key to toggle between On and Off and select one. |
| 2. Enable beep LIMIT [Beep] <On> or <Off> | Press the LIMIT hot key. Press the Beep soft key to toggle between On and Off and select one. This will make audible alarm if the measurement result goes beyond the limit. |

- n **TEST LIMIT:** Enables or disables Pass/Fail results on the display screen. Toggle the **Test Limit** soft key to set it to **On** or **Off**.

Measurement Example

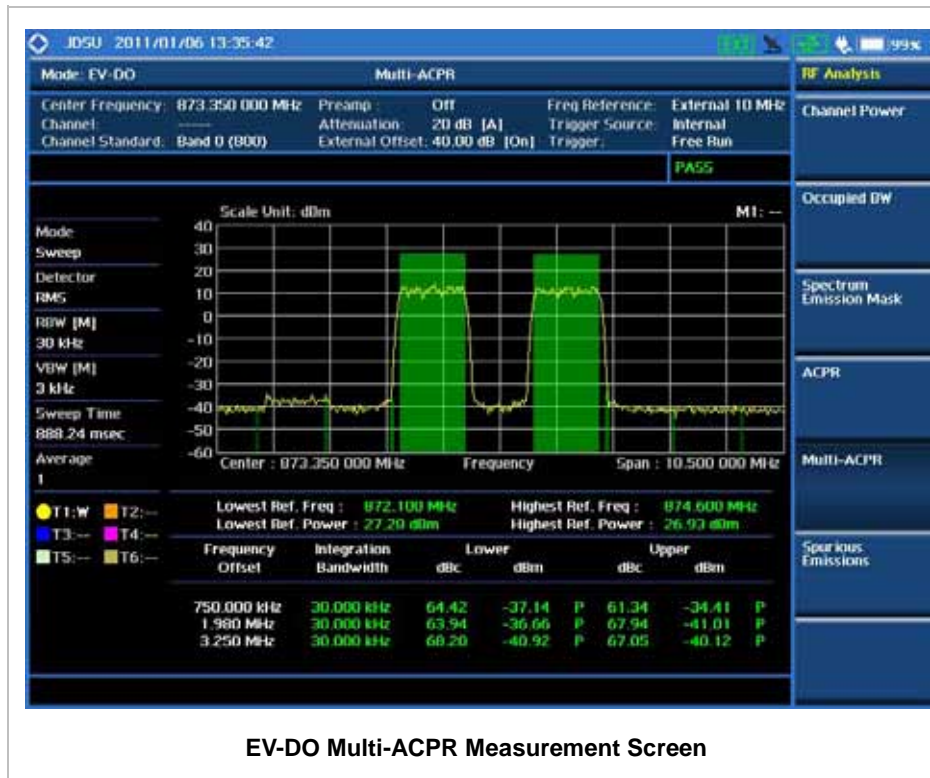

EV-DO Multi-ACPR Measurement Screen

SPURIOUS EMISSIONS

Out-of-band emissions are unwanted emissions immediately outside the channel bandwidth resulting from the modulation process and non-linearity in the transmitter but excluding spurious emissions. The Spurious Emissions measurement is to identify and determine the power level of out-of-band spurious emission within the necessary channel bandwidth and modulated signal measured at the RF port of the Base Station.

Measurement Procedure

| Step | Description |
|------|--------------------------|
| 1. | Set the measurement mode |

| | |
|--|---|
| <p>MEASURE [RF Analysis] [Spurious Emissions]</p> | <p>Press the MEASURE hot key. Press the RF Analysis soft key. Press the Spurious Emissions soft key.</p> |
| <p>2. Set the measurement parameters MEASURE SETUP [Range Table] [Range] Enter a value [Enter] [Start Frequency] Enter a value [GHz], [MHz], [kHz], or [Hz] [Stop Frequency] Enter a value [GHz], [MHz], [kHz], or [Hz] [Start Limit] Enter a value [dBm] [Stop Limit] Enter a value [dBm] [Attenuation] Enter a value [dB] or ENTER [RBW] Enter a value [GHz], [MHz], [kHz], or [Hz] [VBW] Enter a value [GHz], [MHz], [kHz], or [Hz] [Measure Type] <Examine> or <Full> [Average] Enter a value [Enter] or ENTER</p> | <p>Press the MEASURE SETUP hot key. Press the Range Table soft key. Press the Range soft key. Use the numeric keys to select the range number. Press the Enter soft key. Press the Start Frequency soft key. Use the numeric keys. Press one of the unit soft keys to select. Press the Stop Frequency soft key. Use the numeric keys. Press one of the unit soft keys to select. Press the Start Limit soft key. Use the numeric keys. Press the unit soft key to complete the input. Press the Stop Limit soft key. Use the numeric keys. Press the unit soft key to complete the input. Press the Attenuation soft key. Use the numeric keys to enter input value in the multiple of 5. Press the dB unit soft key or the ENTER hard key. Press the RBW soft key. Use the numeric keys. Press one of the unit soft keys to select. Press the VBW soft key. Use the numeric keys. Press one of the unit soft keys to select. Press the Measure Type soft key to toggle between Examine and Full. Press the Average soft key. Use the numeric keys to enter a value. Press the Enter soft key or the ENTER hard key.</p> |

EV-DO Spurious Emissions Measurement Procedure

MEASURE SETUP



Sets the measurement parameters including range table and measurement type. The measurement

settings can be saved and recalled as a file. Also, JDViewer, PC application software allows the user to set the parameters in the user's computer to import into the instrument.

- n **RANGE TABLE:** Sets the range table parameters.
 - Y **RANGE:** Adds a new range number or selects one of the existing range numbers to show or hide the particular frequency range in the range table at the bottom of the screen. Use the numeric keys to enter a range number and press the **Enter** soft key to complete the input. Each time the **Range** soft key is press, it toggles between **On** and **Off**.
 - Y **START FREQUENCY:** Sets or changes the start frequency value to be measured for the selected range number in the Range menu. Use the numeric keys to enter a value and press one of the unit soft keys.
 - Y **STOP FREQUENCY:** Sets or changes the stop frequency value to be measured for the selected range number in the Range menu. Use the numeric keys to enter a value and press one of the unit soft keys.
 - Y **START LIMIT:** Sets the start value of the limit line for the displayed range.
 - Y **STOP LIMIT:** Sets the stop value of the limit line for the displayed range.
 - Y **ATTENUATION:** Sets the attenuation value in the multiple of 5.
 - Y **RBW:** Sets the resolution bandwidth for the selected range number in the Range menu.
 - Y **VBW:** Sets the video bandwidth for the selected range number in the Range menu.
- n **MEASURE TYPE:** Sets the measurement type to **Examine** or **Full**. Toggle between **Examine** and **Full**. Examine mode will show selected range only. The instrument will automatically switch and show all ranges when Full is selected.
- n **RANGE:** Selects the range number to be displayed on the screen. This key is activated only when the **Measure Type** is set to **Examine** mode. Use the numeric keys to select one of the existing range numbers that are configured in the Range Table menu. Pressing the **Enter** soft key completes the input and changes the display.
- n **AVERAGE:** Sets the frequency the number of trace to be averaged.

Setting Limit



This hot key is used to set the threshold value for the limit line on the display screen. It turns on or off the limit or band limit settings of the measurement for pass/fail indication. The user input window must be inactive first to get the Limit hot key function other than the number input.

| Step | Description |
|--|--|
| 1. Select the limit LIMIT [RF Test Limits] [Spurious Emissions] [Test Limit] <On> or <Off> | Press the LIMIT hot key. Press the RF Test Limits soft key. Press the Spurious Emissions soft key. Press the Test Limit soft key to toggle between On and Off and select one. |
| 2. Enable beep LIMIT [Beep] <On> or <Off> | Press the LIMIT hot key. Press the Beep soft key to toggle between On and Off and select one. This will make audible alarm if the measurement result goes beyond the limit. |

- n **TEST LIMIT:** Enables or disables Pass/Fail results on the display screen. Toggle the **Test Limit** soft key to set it to **On** or **Off**.

Measurement Example

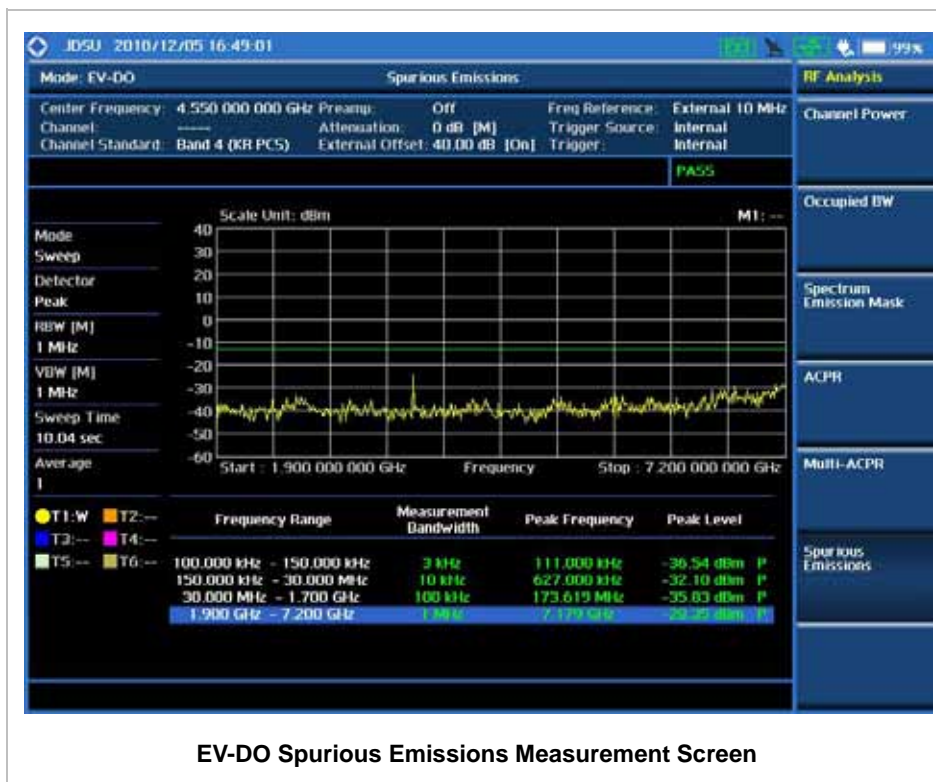

POWER VS TIME ANALYSIS MEASUREMENTS

The Power vs Time (Idle Slot and Active Slot) in EV-DO Signal Analyzer verifies that the transmitter output power has the correct amplitude, shape, and timing for EV-DO format.

- n Idle Slot: Slot with no data in traffic channel.
- n Active Slot: Slot with the loaded data in traffic channel.

Forward link of 1xEV-DO is a frame structure and each frame consists of 16 slots. The frame period for 1xEV-DO is 26.667ms, which is also the period of one pilot channel. Each frame is divided into 16 slots of 1.666ms. 1xEVDO uses CDMA modulation scheme, but unlike its previous systems the Pilot, MAC (Media Access Control), and Data (Traffic) Channel are not transmitted simultaneously; instead they are transmitted in TDM (Time Division Multiplex).

Setting Mode

| Step | Description |
|---|---|
| 1. Connect the cable | Connect a cable directly or indirectly as shown in the section Connecting a Cable on page 7 of this chapter. |
| 2. Select the mode MODE [Signal Analyzer] [EV-DO] [Power vs Time] [Power vs Time (Idle Slot)] or [Power vs Time (Active Slot)] | Press the MODE hard key. Press the Signal Analyzer soft key. Press the EV-DO soft key. Press the Power vs Time soft key. Press one of the measurement mode soft keys to select. |

Setting Frequency

| Step | Description |
|--|--|
| 1. Set the frequency FREQ/DIST [Unit] <Freq> or <Channel> <i>When Freq is selected:</i> | Press the FREQ/DIST hard key. Press the Unit soft key. Toggle this key between Freq and Channel . A set of Freq/Dist screen menu changes accordingly. |

| | |
|---|--|
| <p>[Center Frequency] Enter a value [GHz], [MHz], [kHz], or [Hz]</p> | <p>Press the Center Frequency soft key. Use the numeric keys, the rotary knob, or the arrow keys. When using the numeric keys, the input is completed by selecting one of the unit soft keys.</p> |
| <p><i>When Channel is selected:</i> [Channel Standard] Select a channel standard</p> | <p>Press the Channel Standard soft key. Press the arrow keys, rotate the knob, or press the Page Up and Page Down soft keys to highlight a frequency band to select.</p> |
| <p>[Select] or ENTER</p> | <p>Press the Select soft key or the ENTER hard key.</p> |
| <p>[Channel Number] Enter a value [Forward]</p> | <p>Press the Channel Number soft key. Use the numeric keys to input value and press the Forward soft key to complete the input. The instrument automatically displays its corresponding center frequency value for the channel number.</p> |

FREQ/DIST



- n **UNIT:** Determines the way how to set the frequency band either with standard band or custom frequency band. Toggling this key between **Freq** and **Channel** changes a set of Freq/Dist screen menu automatically.
- n **CENTER FREQUENCY:** Changes the center frequency setting. Use the rotary knob or the arrow keys. Or use the numeric keys to input a certain value and press one of the unit soft keys to complete the input.
- n **FREQUENCY STEP:** Defines the amount of frequency to be increased or decreased when using the rotary knob or the arrow keys to change the **Center Frequency**. This frequency step size can be entered by using numeric keys and the unit soft keys.
- n **CHANNEL NUMBER:** Enters a channel number. The instrument automatically displays its corresponding center frequency value for the channel number.
- n **CHANNEL STEP:** Defines the amount of channel to be increased or decreased when using the rotary knob or the arrow keys to change the **Channel Number**. This channel step size can be entered by using numeric keys and the **Enter** soft key.
- n **CHANNEL STANDARD:** When the channel standard is selected from the list, the center frequency information on the display screen will be mapped accordingly to the selected channel standard. The channel standards available in the instrument are listed in the Appendix C – Band, Frequency & Channel Standard.

Setting Amplitude

| Step | Description |
|--|---|
| 1. Set the reference/attenuation level | |
| AMP/SCALE | Press the AMP/SCALE hard key. |
| [Auto Scale] | Press the Auto Scale soft key to automatically set optimum levels of reference and attenuation. |
| or | |
| [Reference Level] | Press the Reference Level soft key to set manually. |
| Enter a reference level value | Use the numeric keys or the rotary knob that changes in a 10 dB step. |
| [dBm] or ENTER | Press the dBm soft key or the ENTER hard key. |
| [Attenuation] | Press the Attenuation soft key. The Auto mode is set by default. This key toggles between the Auto and Manual . |
| <Manual> | Press the Attenuation soft key to highlight the Manual mode and change the attenuation value to optimize S/N. |
| Enter an attenuation value | Use the numeric keys or the rotary knob that changes in a 5 dB step. The attenuation setting range is 0 to 50 dB. |

AMP/SCALE



- n **AUTO SCALE:** The instrument can automatically set the scale to the minimum and maximum values on the Y-axis of the graph for optimum display of the traces measured. Each time the **Auto Scale** is selected, the top and bottom scales are set to the minimum and maximum values with margin on the Y-axis of the display screen.
- n **REFERENCE LEVEL:** Sets the maximum Y-axis range.
- n **ATTENUATION**
 - Y **AUTO:** Input attenuator's value is automatically set depending on the reference level. This is the default operation mode, so it is recommended to use this mode unless a special measurement condition is needed.
 - Y **MANUAL:** Sets the attenuator's value for the **Spectrum Analyzer RF In 50 Ω** port.
- n **PREAMP:** Turns on or off the internal pre-amplifier. Preamp results in a correction being applied to compensate for the gain of the preamp so that amplitude readings show the value at the input connector. This soft key toggles between the **On** and **Off**. When it is set to On, the allowable attenuation input range is from 0 dB to 10 dB in a multiple of 5. If the attenuation value is manually set greater than 10 dB, the instrument will automatically turn off the pre-amplifier to display low level signal properly on the screen.

- n **EXTERNAL OFFSET:** Sets an external offset value. An offset consists of a cable loss and a user offset and the measurement result shows the value reflecting both offset values. When the external offset value is set at 40 dB in the Spectrum mode, the measurement result compensates 40 dB at both the Spectrum Analyzer and Signal Analyzer modes.

Setting Averaging



- n **AVERAGE:** Sets the number of measurements to be averaged. Press one of the data point soft keys to select among **128**, **256**, **512**, and **1024**.

| Step | Description |
|--|--|
| 1. Set the averaging BW/AVG [Average] [128], [256], [512], or [1024] | Press the BW/AVG hard key. Press the Average soft key. Press one of the soft keys to select. |

Setting Sweep Mode



This hot key is used to set the sweep parameters. The user input window must be inactive first to get the Sweep hot key function other than the number input.

- n **SWEEP MODE:** Sets the sweep method. Toggle between **Continue** and **Single**.

| Step | Description |
|--|---|
| 1. Set the sweep mode SWEEP [Sweep Mode] | Press the SWEEP hot key. Press the Sweep Mode soft key. Toggle between Continue and Single . |

Setting Trigger Source



This hot key is used to select the trigger source among **Internal**, **External**, and **GPS**. The user input window must be inactive first to get the Trigger hot key function other than the number input.

Setting External Clock

To enhance the reliability of modulation analysis measurements the JD740A series must be synchronized with the Base Station. When an external clock is not supplied, the JD740A series works with a built-in internal high-accuracy time base. In this case, some measurement results may exhibit inaccurate values. Therefore, it is highly recommended to use the same reference clock as signal source. Trigger mode can be changed by using the **TRIGGER** hot key.

EXTERNAL CLOCK OPERATING STANDARDS

| Clock | Type | Reference | Port | Switching Standard |
|--------------------|----------|--------------------|---------------|--|
| External Reference | Internal | Internal 10 MHz | | Default |
| | External | External Ref Clock | Ext Ref (SMA) | Manual switching (Input signal level >-3 dBm) |
| | GPS | GPS Clock | GPS (SMA) | Automatic switching (GPS signal received) |
| Trigger | Internal | Internal Trigger | | Default |
| | External | External Trigger | Trigger (SMA) | Manual switching |
| | GPS | GPS | GPS (SMA) | Manual switching |

CONNECTION

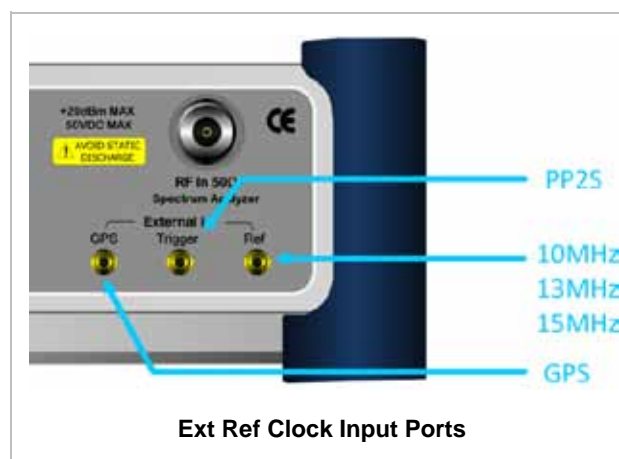

ENABLING EXTERNAL REFERENCE

| Step | Description |
|----------------------------------|---|
| 1. Connect an external reference | Connect one of the external references or a GPS antenna to the JD740A series. |

| | |
|---|---|
| <p>2. Change reference clock SYSTEM [Frequency Reference] [External 10 MHz], [External 13 MHz], [External 15 MHz] or [GPS]</p> | <p>Press the SYSTEM hot key. Press the Frequency Reference soft key to select one of the external reference clocks or GPS. Press one of the soft keys to choose among External 10 MHz, External 13 MHz, External 15 MHz, and GPS.</p> |
|---|---|

EXTERNAL REFERENCE INDICATOR INFORMATION

Each indicator tells different locking status according to a connection. When a GPS antenna is connected, longitude and latitude information will be displayed on the screen.

| Type | Indicator | Description |
|----------|--|----------------------------------|
| Internal |  (Green) | Locked |
| External |  (Green) | Locked |
| |  (Red) | Unlocked |
| GPS |  (Green) | Locked |
| |  (Yellow) | Locking in progress |
| |  (Gray) | Unable to lock or antenna failed |

POWER VS TIME (IDLE SLOT)

The Power vs Time (Idle Slot) measurement provides the idle slot that includes the Pilot and MAC channels with the masks in all regions.

Measurement Procedure

| Step | Description |
|--|--|
| <p>1. Set the measurement mode MEASURE [Power vs Time] [Power vs Time (Idle Slot)]</p> | <p>Press the MEASURE hot key. Press the Power vs Time soft key. Press the Power vs Time (Idle Slot) soft key.</p> |

EV-DO Power vs Time (Idle Slot) Measurement Procedure

Setting Limit

LIMIT



This hot key is used to set the threshold value for the limit line on the display screen. It turns on or off the limit or band limit settings of the measurement for pass/fail indication. The user input window must be inactive first to get the Limit hot key function other than the number input.

| Step | Description |
|--|--|
| 1. Select the limit LIMIT [PvsT Test Limits] [Pilot Power] [Test Limits] <On> or <Off> [High Limit] [Low Limit] [MAC Power] [Test Limits] <On> or <Off> [High Limit] [Low Limit] [Data Power] [Test Limits] <On> or <Off> [High Limit] [Low Limit] [On/Off Ratio] [Test Limit] <On> or <Off> [Low Limit] | Press the LIMIT hot key. Press the PvsT Test Limits soft key. Press the Pilot Power soft key. Press the Test Limits soft key. Toggle between On and Off . Use the numeric keys and input a number in dBm Use the numeric keys and input a number in dBm. Press the MAC Power soft key. Press the Test Limits soft key. Toggle between On and Off . Use the numeric keys and input a number in dBm. Use the numeric keys and input a number in dBm. Press the Data Power soft key. Press the Test Limits soft key. Toggle between On and Off . Use the numeric keys and input a number in dBm. Use the numeric keys and input a number in dBm. Press the On/Off Ratio soft key. Press the Test Limit soft key. Toggle between On and Off . Use the numeric keys and input a number in dB. |
| 2. Enable beep LIMIT [Beep] <On> or <Off> | Press the LIMIT hot key. Press the Beep soft key to toggle between On and Off and select one. This will make audible alarm if the measurement result goes beyond the limit. |

n **PILOT POWER:** Sets the pilot power limit.

Y **TEST LIMITS:** Enables or disables the test limits. Toggle the **Test Limits** soft key between

On and Off.

- Y **HIGH LIMIT:** Sets the upper limit. Use the numeric keys to input value and press the unit soft key or the **ENTER** hard key to complete the input.
- Y **LOW LIMIT:** Sets the lower limit. Use the numeric keys to input value and press the unit soft key or the **ENTER** hard key to complete the input.
- n **MAC POWER:** Sets the medium access control power limit.
 - Y **TEST LIMITS:** Enables or disables the test limits. Toggle the **Test Limits** soft key between **On** and **Off**.
 - Y **HIGH LIMIT:** Sets the upper limit. Use the numeric keys to input value and press the unit soft key or the **ENTER** hard key to complete the input.
 - Y **LOW LIMIT:** Sets the lower limit. Use the numeric keys to input value and press the unit soft key or the **ENTER** hard key to complete the input.
- n **DATA POWER:** Sets the limit of the idle data power during the data period of an idle slot.
 - Y **TEST LIMITS:** Enables or disables the test limits. Toggle the **Test Limits** soft key between **On** and **Off**.
 - Y **HIGH LIMIT:** Sets the upper limit. Use the numeric keys to input value and press the unit soft key or the **ENTER** hard key to complete the input.
 - Y **LOW LIMIT:** Sets the lower limit. Use the numeric keys to input value and press the unit soft key or the **ENTER** hard key to complete the input.
- n **ON/OFF RATIO:** Sets the limit of the idle on/off power ratio of the Pilot and MAC Power to the Data Power.
 - Y **TEST LIMIT:** Enables or disables the test limits. Toggle the **Test Limit** soft key between **On** and **Off**.
 - Y **LOW LIMIT:** Sets the lower limit. Use the numeric keys to input value and press the unit soft key or the **ENTER** hard key to complete the input.

Measurement Example



POWER VS TIME (ACTIVE SLOT)

The Power vs Time (Active Slot) measurement that includes the Pilot, MAC, and Data channels with the upper and lower masks.

Measurement Procedure

| Step | Description |
|---|---|
| 1. Set the measurement mode MEASURE [Power vs Time] [Power vs Time (Active Slot)] | Press the MEASURE hot key. Press the Power vs Time soft key. Press the Power vs Time (Active Slot) soft key. |

EV-DO Power vs Time (Active Slot) Measurement Procedure

Setting Limit



This hot key is used to set the threshold value for the limit line on the display screen. It turns on or off

the limit or band limit settings of the measurement for pass/fail indication. The user input window must be inactive first to get the Limit hot key function other than the number input.

| Step | Description |
|--|--|
| <p>1. Select the limit</p> <p>LIMIT</p> <p>[PvsT Test Limits]</p> <p>[Pilot Power]</p> <p>[Test Limits]</p> <p><On> or <Off></p> <p>[High Limit]</p> <p>[Low Limit]</p> <p>[MAC Power]</p> <p>[Test Limits]</p> <p><On> or <Off></p> <p>[High Limit]</p> <p>[Low Limit]</p> <p>[Data Power]</p> <p>[Test Limits]</p> <p><On> or <Off></p> <p>[High Limit]</p> <p>[Low Limit]</p> <p>[On/Off Ratio]</p> <p>[Test Limit]</p> <p><On> or <Off></p> <p>[Low Limit]</p> | <p>Press the LIMIT hot key.</p> <p>Press the PvsT Test Limits soft key.</p> <p>Press the Pilot Power soft key.</p> <p>Press the Test Limits soft key. Toggle between On and Off.</p> <p>Use the numeric keys and input a number in dBm</p> <p>Use the numeric keys and input a number in dBm.</p> <p>Press the MAC Power soft key.</p> <p>Press the Test Limits soft key. Toggle between On and Off.</p> <p>Use the numeric keys and input a number in dBm.</p> <p>Use the numeric keys and input a number in dBm.</p> <p>Press the Data Power soft key.</p> <p>Press the Test Limits soft key. Toggle between On and Off.</p> <p>Use the numeric keys and input a number in dBm.</p> <p>Use the numeric keys and input a number in dBm.</p> <p>Press the On/Off Ratio soft key.</p> <p>Press the Test Limit soft key. Toggle between On and Off.</p> <p>Use the numeric keys and input a number in dB.</p> |
| <p>2. Enable beep</p> <p>LIMIT</p> <p>[Beep]</p> <p><On> or <Off></p> | <p>Press the LIMIT hot key.</p> <p>Press the Beep soft key to toggle between On and Off and select one. This will make audible alarm if the measurement result goes beyond the limit.</p> |

n **PILOT POWER:** Sets the pilot power limit.

Y **TEST LIMITS:** Enables or disables the test limits. Toggle the **Test Limits** soft key between **On** and **Off**.

Y **HIGH LIMIT:** Sets the upper limit. Use the numeric keys to input value and press the unit soft key or the **ENTER** hard key to complete the input.

Y **LOW LIMIT:** Sets the lower limit. Use the numeric keys to input value and press the unit soft key or the **ENTER** hard key to complete the input.

- n **MAC POWER:** Sets the medium access control power limit.
 - Y **TEST LIMITS:** Enables or disables the test limits. Toggle the **Test Limits** soft key between **On** and **Off**.
 - Y **HIGH LIMIT:** Sets the upper limit. Use the numeric keys to input value and press the unit soft key or the **ENTER** hard key to complete the input.
 - Y **LOW LIMIT:** Sets the lower limit. Use the numeric keys to input value and press the unit soft key or the **ENTER** hard key to complete the input.

- n **DATA POWER:** Sets the limit of the idle data power during the data period of an idle slot.
 - Y **TEST LIMITS:** Enables or disables the test limits. Toggle the **Test Limits** soft key between **On** and **Off**.
 - Y **HIGH LIMIT:** Sets the upper limit. Use the numeric keys to input value and press the unit soft key or the **ENTER** hard key to complete the input.
 - Y **LOW LIMIT:** Sets the lower limit. Use the numeric keys to input value and press the unit soft key or the **ENTER** hard key to complete the input.

- n **ON/OFF RATIO:** Sets the limit of the idle on/off power ratio of the Pilot and MAC Power to the Data Power.
 - Y **TEST LIMIT:** Enables or disables the test limits. Toggle the **Test Limit** soft key between **On** and **Off**.
 - Y **LOW LIMIT:** Sets the lower limit. Use the numeric keys to input value and press the unit soft key or the **ENTER** hard key to complete the input.

Measurement Example



MODULATION ANALYSIS MEASUREMENTS

Modulation Analysis in EV-DO Signal Analyzer provides single-button measurements for the following essential measurements.

- n Constellation
- n Code Domain Power (CDP)
- n MAC Codogram
- n Received Code Strength Indicator (RCSI)
- n MAC CDP Table

Setting Mode

| Step | Description |
|----------------------|--|
| 1. Connect the cable | Connect a cable directly or indirectly as shown in the section Connecting a Cable on page 7 of this chapter. |

| | |
|---|--|
| <p>2. Select the mode</p> <p>MODE</p> <p>[Signal Analyzer]</p> <p>[EV-DO]</p> <p>[Modulation Analysis]</p> <p>[Constellation],</p> <p>[Code Domain Power],</p> <p>[MAC Codogram],</p> <p>[RCSI], or</p> <p>[MAC CDP Table]</p> | <p>Press the MODE hard key.</p> <p>Press the Signal Analyzer soft key.</p> <p>Press the EV-DO soft key.</p> <p>Press the Modulation Analysis soft key.</p> <p>Press one of the measurement mode soft keys to select.</p> |
|---|--|

Setting Frequency

| Step | Description |
|--|--|
| <p>1. Set the frequency</p> <p>FREQ/DIST</p> <p>[Unit]</p> <p><Freq> or <Channel></p> <p><i>When Freq is selected:</i></p> <p>[Center Frequency]</p> <p>Enter a value</p> <p>[GHz], [MHz], [kHz], or [Hz]</p> <p><i>When Channel is selected:</i></p> <p>[Channel Standard]</p> <p>Select a channel standard</p> <p>[Select] or ENTER</p> <p>[Channel Number]</p> <p>Enter a value</p> <p>[Forward]</p> | <p>Press the FREQ/DIST hard key.</p> <p>Press the Unit soft key. Toggle this key between Freq and Channel. A set of Freq/Dist screen menu changes accordingly.</p> <p>Press the Center Frequency soft key.</p> <p>Use the numeric keys, the rotary knob, or the arrow keys.</p> <p>When using the numeric keys, the input is completed by selecting one of the unit soft keys.</p> <p>Press the Channel Standard soft key.</p> <p>Press the arrow keys, rotate the knob, or press the Page Up and Page Down soft keys to highlight a frequency band to select.</p> <p>Press the Select soft key or the ENTER hard key.</p> <p>Press the Channel Number soft key.</p> <p>Use the numeric keys to input value and press the Forward soft key to complete the input. The instrument automatically displays its corresponding center frequency value for the channel number.</p> |

FREQ/DIST

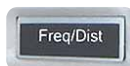

n **UNIT:** Determines the way how to set the frequency band either with standard band or custom

frequency band. Toggling this key between **Freq** and **Channel** changes a set of Freq/Dist screen menu automatically.

- n **CENTER FREQUENCY:** Changes the center frequency setting. Use the rotary knob or the arrow keys. Or use the numeric keys to input a certain value and press one of the unit soft keys to complete the input.
- n **FREQUENCY STEP:** Defines the amount of frequency to be increased or decreased when using the rotary knob or the arrow keys to change the **Center Frequency**. This frequency step size can be entered by using numeric keys and the unit soft keys.
- n **CHANNEL NUMBER:** Enters a channel number. The instrument automatically displays its corresponding center frequency value for the channel number.
- n **CHANNEL STEP:** Defines the amount of channel to be increased or decreased when using the rotary knob or the arrow keys to change the **Channel Number**. This channel step size can be entered by using numeric keys and the **Enter** soft key.
- n **CHANNEL STANDARD:** When the channel standard is selected from the list, the center frequency information on the display screen will be mapped accordingly to the selected channel standard. The channel standards available in the instrument are listed in the table in the Appendix C – Band, Frequency & Channel Standard.

Setting Amplitude

| Step | Description |
|--|---|
| 1. Set the reference/attenuation level AMP/SCALE [Auto Scale] or [Reference Level] Enter a reference level value [dBm] or ENTER [Attenuation] <Manual> Enter an attenuation value | Press the AMP/SCALE hard key. Press the Auto Scale soft key to automatically set optimum levels of reference and attenuation. Press the Reference Level soft key to set manually. Use the numeric keys or the rotary knob that changes in a 10 dB step. Press the dBm soft key or the ENTER hard key. Press the Attenuation soft key. The Auto mode is set by default. This key toggles between the Auto and Manual . Press the Attenuation soft key to highlight the Manual mode and change the attenuation value to optimize S/N. Use the numeric keys or the rotary knob that changes in a 5 dB step. The attenuation setting range is 0 to 50 dB. |

AMP/SCALE



- n **AUTO SCALE:** The instrument can automatically set the scale to the minimum and maximum values on the Y-axis of the graph for optimum display of the traces measured. Each time the **Auto Scale** is selected, the top and bottom scales are set to the minimum and maximum values with margin on the Y-axis of the display screen.
- n **REFERENCE:** Sets the display of measurement result to relative or absolute value. Toggle between **Abs** for absolute and **Rel** for relative. *This key is used in the Code Domain Power mode and the MAC Codogram mode.*
 - Y **ABS:** The code domain power is measured absolute to channel power.
 - Y **REL:** The code domain power is measured relative to channel power.
- n **REFERENCE LEVEL:** Sets the maximum Y-axis range. This key is activated only when the **Reference** is set to the **Abs** mode. *This key is not used in the Constellation mode and the MAC CDP Table mode.*
- n **ATTENUATION**
 - Y **AUTO:** Input attenuator's value is automatically set depending on the reference level. This is the default operation mode, so it is recommended to use this mode unless a special measurement condition is needed.
 - Y **MANUAL:** Sets the attenuator's value for the **Spectrum Analyzer RF In 50 Ω** port.
- n **PREAMP:** Turns on or off the internal pre-amplifier. Preamp results in a correction being applied to compensate for the gain of the preamp so that amplitude readings show the value at the input connector. This soft key toggles between the **On** and **Off**. When it is set to **On**, the allowable attenuation input range is from 0 dB to 10 dB in a multiple of 5. If the attenuation value is manually set greater than 10 dB, the instrument will automatically turn off the pre-amplifier to display low level signal properly on the screen.
- n **EXTERNAL OFFSET:** Sets an external offset value. An offset consists of a cable loss and a user offset and the measurement result shows the value reflecting both offset values. When the external offset value is set at 40 dB in the Spectrum mode, the measurement result compensates 40 dB at both the Spectrum Analyzer and Signal Analyzer modes.

Setting Sweep Mode

SWEEP



This hot key is used to set the sweep parameters. The user input window must be inactive first to get

the Sweep hot key function other than the number input.

- n **SWEEP MODE:** Sets the sweep method. Toggle between **Continue** and **Single**.

| Step | Description |
|---|---|
| 1. Set the sweep mode SWEEP [Sweep Mode] | Press the SWEEP hot key. Press the Sweep Mode soft key. Toggle between Continue and Single . |

Setting Trigger Source



This hot key is used to select the trigger source among **Internal**, **External**, and **GPS**. The user input window must be inactive first to get the Trigger hot key function other than the number input.

Setting External Clock

To enhance the reliability of modulation analysis measurements the JD740A series must be synchronized with the Base Station. When an external clock is not supplied, the JD740A series works with a built-in internal high-accuracy time base. In this case, some measurement results may exhibit inaccurate values. Therefore, it is highly recommended to use the same reference clock as signal source. Trigger mode can be changed by using the **TRIGGER** hot key.

EXTERNAL CLOCK OPERATING STANDARDS

| Clock | Type | Reference | Port | Switching Standard |
|--------------------|----------|--------------------|---------------|--|
| External Reference | Internal | Internal 10 MHz | | Default |
| | External | External Ref Clock | Ext Ref (SMA) | Manual switching (Input signal level >-3 dBm) |
| | GPS | GPS Clock | GPS (SMA) | Automatic switching (GPS signal received) |
| Trigger | Internal | Internal Trigger | | Default |
| | External | External Trigger | Trigger (SMA) | Manual switching |
| | GPS | GPS | GPS (SMA) | Manual switching |

CONNECTION

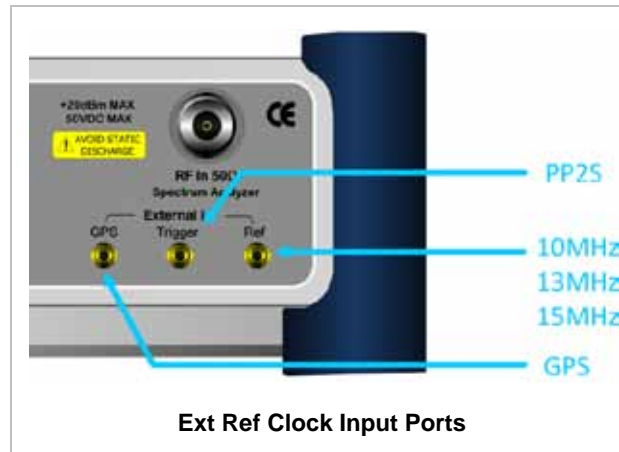

ENABLING EXTERNAL REFERENCE

| Step | Description |
|--|---|
| 1. Connect an external reference | Connect one of the external references or a GPS antenna to the JD740A series. |
| 2. Change reference clock SYSTEM [Frequency Reference] [External 10 MHz], [External 13 MHz], [External 15 MHz] or [GPS] | <p>Press the SYSTEM hot key.</p> <p>Press the Frequency Reference soft key to select one of the external reference clocks or GPS.</p> <p>Press one of the soft keys to choose among External 10 MHz, External 13 MHz, External 15 MHz, and GPS.</p> |

EXTERNAL REFERENCE INDICATOR INFORMATION

Each indicator tells different locking status according to a connection. When a GPS antenna is connected, longitude and latitude information will be displayed on the screen.

| Type | Indicator | Description |
|----------|-----------|----------------------------------|
| Internal | (Green) | Locked |
| External | (Green) | Locked |
| | (Red) | Unlocked |
| GPS | (Green) | Locked |
| | (Yellow) | Locking in progress |
| | (Gray) | Unable to lock or antenna failed |

CONSTELLATION

The Constellation is used to analyze transmitter modulation performance. The JD740A series displays the constellation diagram with modulation metrics to characterize the performance.

Measurement Procedure

| Step | Description |
|--|--|
| 1. Set the measurement mode MEASURE [Modulation Analysis] [Constellation] [Composite 64], [Composite 128], [Pilot], [MAC 64], [MAC 128], or [Data] | Press the MEASURE hot key. Press the Modulation Analysis soft key. Press the Constellation soft key. Press one of the measurement mode soft keys to select. |
| 2. Set the measurement parameters MEASURE SETUP [PN Offset] <Auto> or <Manual> Enter a value [Enter] [PN Increment] Enter a value [Enter] [Detect Mode] [Auto], [QPSK], [8PSK], [16QAM], or [64QAM] | Press the MEASURE SETUP hot key. Press the PN Offset soft key. The Auto mode is set by default. Toggle between Auto and Manual . Use the numeric keys to input value. Press the Enter soft key. Press the PN Increment soft key. Use the numeric keys to input value. Press the Enter soft key. Press the Detect Mode soft key. Press one of the soft keys to select the detection mode for Data Constellation. |

EV-DO Constellation Measurement Procedure

MEASURE SETUP



- n **PN OFFSET:** Sets the PN Offset (Pseudo-Noise Offset) to **Auto** or **Manual**. Toggle between **Auto** and **Manual**. To change the value in the **Manual** mode, use the numeric keys and press the **Enter** soft key or the **ENTER** hard key to complete to the input.
- n **PN INCREMENT:** Sets the increment step for the PN Offset. Use the numeric keys to enter a

value and press the Enter soft key or the ENTER hard key to complete to the input.

- n **DETECT MODE:** Sets the detection mode for Data Constellation among **Auto**, **QPSK**, **8PSK**, **16QAM**, and **64QAM** for Data.

Setting Limit



This hot key is used to set the threshold value for the limit line on the display screen. It turns on or off the limit or band limit settings of the measurement for pass/fail indication. The user input window must be inactive first to get the Limit hot key function other than the number input.

| Step | Description |
|---------------------------------|--|
| 1. Select the limit | |
| LIMIT | Press the LIMIT hot key. |
| [Modulation Test Limits] | Press the Modulation Test Limits soft key. |
| [Frequency Error] | Press the Frequency Error soft key. |
| [Test Limits] | Press the Test Limits soft key. Toggle between On and Off . |
| <On> or <Off> | |
| [High Limit] | Use the numeric keys and input a number in ppm. |
| [Low Limit] | Use the numeric keys and input a number in ppm. |
| [Time Offset] | Press the Time Offset soft key. |
| [Test Limits] | Press the Test Limits soft key. Toggle between On and Off . |
| <On> or <Off> | |
| [High Limit] | Use the numeric keys and input a number in us. |
| [Low Limit] | Use the numeric keys and input a number in us. |
| [Carrier Feed Through] | Press the Carrier Feed Through soft key. |
| [Test Limit] | Press the Test Limit soft key. Toggle between On and Off . |
| <On> or <Off> | |
| [High Limit] | Use the numeric keys and input a number in dB. |
| [Pilot Rho] | Press the Pilot Rho soft key. |
| [Test Limit] | Press the Test Limit soft key. Toggle between On and Off . |
| <On> or <Off> | |
| [Low Limit] | Use the numeric keys and input a number. |
| [MAC Rho] | Press the MAC Rho soft key. |
| [Test Limit] | Press the Test Limit soft key. Toggle between On and Off . |
| <On> or <Off> | |

| | |
|--|--|
| <p>[Low Limit]</p> <p>[Data Rho]</p> <p>[Test Limit]</p> <p><On> or <Off></p> <p>[Low Limit]</p> | <p>Use the numeric keys and input a number.</p> <p>Press the Data Rho soft key.</p> <p>Press the Test Limit soft key. Toggle between On and Off.</p> <p>Use the numeric keys and input a number.</p> |
| <p>2. Enable beep</p> <p>LIMIT</p> <p>[Beep]</p> <p><On> or <Off></p> | <p>Press the LIMIT hot key.</p> <p>Press the Beep soft key to toggle between On and Off and select one. This will make audible alarm if the measurement result goes beyond the limit.</p> |

- n **FREQUENCY ERROR:** Sets the frequency error limit.
 - Y **TEST LIMITS:** Enables or disables the test limits. Toggle the **Test Limits** soft key between **On** and **Off**.
 - Y **HIGH LIMIT:** Sets the upper limit. Use the numeric keys to input value and press the unit soft key or the **ENTER** hard key to complete the input.
 - Y **LOW LIMIT:** Sets the lower limit. Use the numeric keys to input value and press the unit soft key or the **ENTER** hard key to complete the input.

- n **TIME OFFSET:** Sets the time offset limit. Time Offset compares the PN offset timing with the overall system time and the instrument checks the start of PN offset in comparison to either the GPS signal or the even second clock signal.
 - Y **TEST LIMITS:** Enables or disables the test limits. Toggle the **Test Limits** soft key between **On** and **Off**.
 - Y **HIGH LIMIT:** Sets the upper limit. Use the numeric keys to input value and press the unit soft key or the **ENTER** hard key to complete the input.
 - Y **LOW LIMIT:** Sets the lower limit. Use the numeric keys to input value and press the unit soft key or the **ENTER** hard key to complete the input.

- n **CARRIER FEED THROUGH:** Sets the limit of carrier feed through. Carrier Feed Through is a result of the RF carrier signal feeding through the I/Q modulator and riding on the output circuitry without being modulated. It sets the limit of carrier feed through.
 - Y **TEST LIMIT:** Enables or disables the test limit. Toggle the **Test Limit** soft key between **On** and **Off**.
 - Y **HIGH LIMIT:** Sets the upper limit. Use the numeric keys to input value and press the unit soft key or the **ENTER** hard key to complete the input.

- n **MAX INACTIVE:** *This key is not used in the Constellation mode.*

- n **PILOT RHO:** Sets the Pilot Rho limit.
 - Y **TEST LIMIT:** Enables or disables the test limit. Toggle the **Test Limit** soft key between **On** and **Off**.
 - Y **LOW LIMIT:** Sets the lower limit. Use the numeric keys to input value and press the **Enter** soft key or the **ENTER** hard key to complete the input.
- n **MAC RHO:** Sets the MAC Rho limit.
 - Y **TEST LIMIT:** Enables or disables the test limit. Toggle the **Test Limit** soft key between **On** and **Off**.
 - Y **LOW LIMIT:** Sets the lower limit. Use the numeric keys to input value and press the **Enter** soft key or the **ENTER** hard key to complete the input.
- n **DATA RHO:** Sets the Data Rho limit.
 - Y **TEST LIMIT:** Enables or disables the test limit. Toggle the **Test Limit** soft key between **On** and **Off**.
 - Y **LOW LIMIT:** Sets the lower limit. Use the numeric keys to input value and press the **Enter** soft key or the **ENTER** hard key to complete the input.

Measurement Example

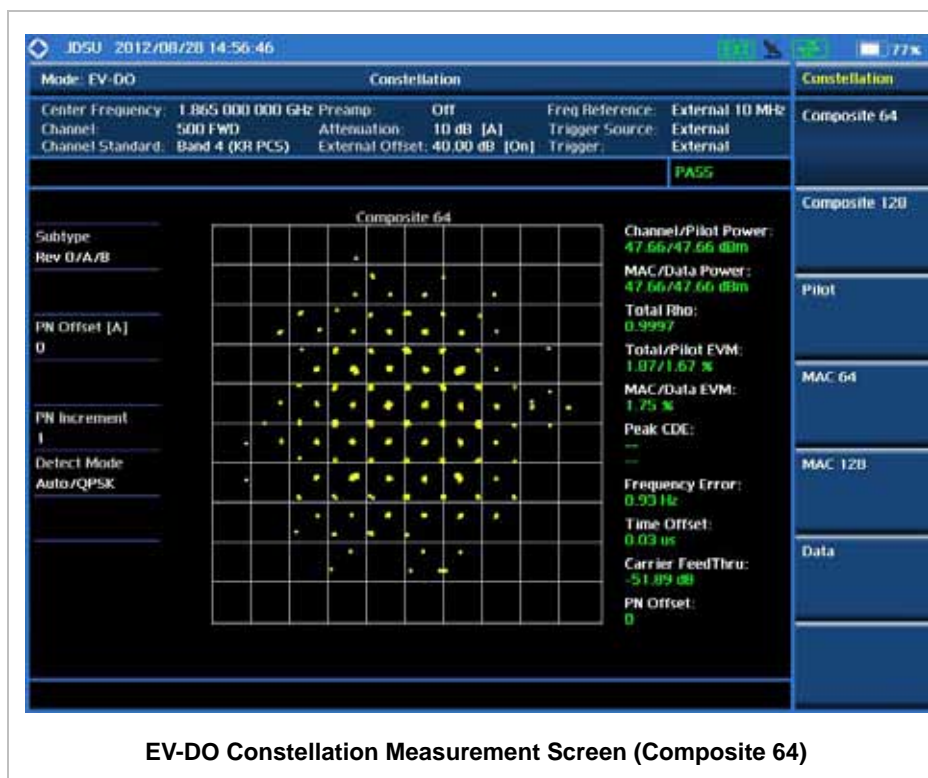

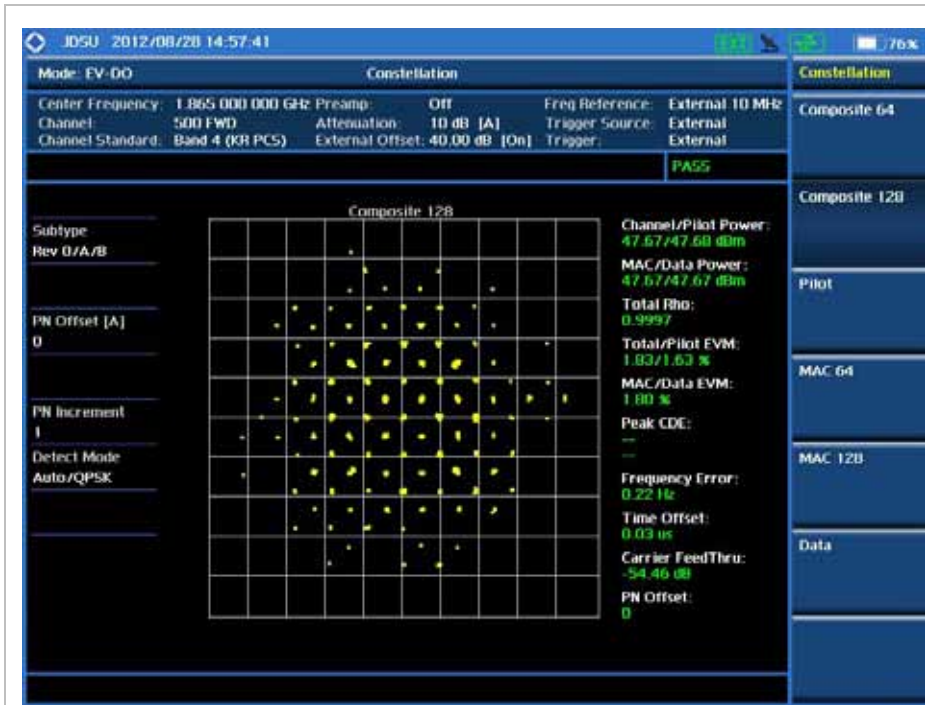

EV-DO Constellation Measurement Screen (Composite 128)



EV-DO Constellation Measurement Screen (Pilot)



EV-DO Constellation Measurement Screen (MAC 64)



EV-DO Constellation Measurement Screen (MAC 128)



CODE DOMAIN POWER

The Code Domain Power (CDP) measurement provides code domain power analysis that measures the distribution of power across the set of code channels, normalized to the total EV-DO power. It helps to verify that each code channel is operating at its proper level and to identify problems throughout the transmitter design from coding to the RF section. System imperfections such as amplifier non-linearity will present themselves as an undesired distribution of power in the code domain.

Measurement Procedure

| Step | Description |
|---|---|
| 1. Set the measurement mode MEASURE [Modulation Analysis] [Code Domain Power] [Pilot], [MAC 64], [MAC 128], or [Data] | Press the MEASURE hot key. Press the Modulation Analysis soft key. Press the Code Domain Power soft key. Press one of the measurement mode soft keys to select. |

| | |
|---|---|
| <p>2. Set the measurement parameters</p> <p>MEASURE SETUP</p> <p>[PN Offset] <Auto> or <Manual> Enter a value [Enter]</p> <p>[PN Increment] Enter a value [Enter]</p> <p>[Threshold] Enter a value [dB]</p> | <p>Press the MEASURE SETUP hot key.</p> <p>Press the PN Offset soft key. The Auto mode is set by default. Toggle between Auto and Manual.</p> <p>Use the numeric keys to input value.</p> <p>Press the Enter soft key.</p> <p>Press the PN Increment soft key.</p> <p>Use the numeric keys to input value.</p> <p>Press the Enter soft key.</p> <p>Press the Threshold soft key.</p> <p>Use the numeric keys to input value.</p> <p>Press the unit soft key.</p> |
|---|---|

EV-DO Code Domain Power Measurement Procedure

MEASURE SETUP



- n **PN OFFSET:** Sets the PN Offset (Pseudo-Noise Offset) to **Auto** or **Manual**. Toggle between **Auto** and **Manual**. To change the value in the **Manual** mode, use the numeric keys and press the **Enter** soft key or the **ENTER** hard key to complete to the input.
- n **PN INCREMENT:** Sets the increment step for the PN Offset. Use the numeric keys to enter a value and press the **Enter** soft key or the **ENTER** hard key to complete to the input.
- n **TRHESHOLD:** Sets the threshold value between Auto and Manual. Its default setting is -27 dB. To change the value in the **Manual** mode, use the numeric keys to enter a value between -50 and 0 and press the **Enter** soft key or the **ENTER** hard key to complete to the input.
- n **DETECT MODE:** *This key is not used in the Code Domain Power mode.*

Setting Limit

LIMIT



This hot key is used to set the threshold value for the limit line on the display screen. It turns on or off the limit or band limit settings of the measurement for pass/fail indication. The user input window must be inactive first to get the Limit hot key function other than the number input.

| Step | Description |
|---|--|
| 1. Select the limit LIMIT [Modulation Test Limits] [Max Inactive] [Test Limit] <On> or <Off> [High Limit] | Press the LIMIT hot key. Press the Modulation Test Limits soft key. Press the Max Inactive soft key. Press the Test Limit soft key. Toggle between On and Off . Use the numeric keys and input a number in dB. |
| 2. Enable beep LIMIT [Beep] <On> or <Off> | Press the LIMIT hot key. Press the Beep soft key to toggle between On and Off and select one. This will make audible alarm if the measurement result goes beyond the limit. |

- n **FREQUENCY ERROR:** *This key is not used in the Code Domain Power mode.*
- n **TIME OFFSET:** *This key is not used in the Code Domain Power mode.*
- n **CARRIER FEED THROUGH:** *This key is not used in the Code Domain Power mode.*
- n **MAX INACTIVE:** Sets the limit of the highest level among inactive channels.
- Y **TEST LIMIT:** Enables or disables the test limit. Toggle the **Test Limit** soft key between **On** and **Off**.
- Y **HIGH LIMIT:** Sets the upper limit. Use the numeric keys to input value and press the unit soft key or the **ENTER** hard key to complete the input.
- n **PILOT RHO:** *This key is not used in the Code Domain Power mode.*
- n **MAC RHO:** *This key is not used in the Code Domain Power mode.*
- n **DATA RHO:** *This key is not used in the Code Domain Power mode.*

Measurement Example



EV-DO Code Domain Power Analysis Measurement Screen (Pilot)



EV-DO Code Domain Power Analysis Measurement Screen (MAC 64)



EV-DO Code Domain Power Analysis Measurement Screen (MAC 128)



EV-DO Code Domain Power Analysis Measurement Screen (Data)

MAC CODOGRAM

The MAC Codogram displays the power variation for every code over time, presenting a clear view of the traffic load per channels at any given time. The MAC Codogram measurements can be saved into an external USB memory so that a post-analysis can be done with the application software JDViewer.

Measurement Procedure

| Step | Description |
|---|--|
| 1. Set the measurement mode MEASURE [Modulation Analysis] [MAC Codogram] | Press the MEASURE hot key. Press the Modulation Analysis soft key. Press the MAC Codogram soft key. |
| 2. Set the measurement parameters MEASURE SETUP [PN Offset] <Auto> or <Manual> Enter a value [Enter] [PN Increment] Enter a value [Enter] [Threshold] Enter a value [dB] [MAC] <64> or <128> [Time Interval] Enter a value [Enter] or [ENTER] [Auto Save] <On> or <Off> | Press the MEASURE SETUP hot key. Press the PN Offset soft key. The Auto mode is set by default. Toggle between Auto and Manual . Use the numeric keys to input value. Press the Enter soft key. Press the PN Increment soft key. Use the numeric keys to input value. Press the Enter soft key. Press the Threshold soft key. Use the numeric keys to input value. Press the unit soft key. Press the MAC soft key. Toggle between 64 and 128 to select the code. Press the Time Interval soft key. Use the numeric keys to input value. Press the soft key to complete the input. Press the Auto Save soft key. Toggle between On and Off . |
| 3. Analyze the measurement result [Time Cursor] <On> or <Off> | Press the Time Cursor soft key. Toggle between On and Off . |

EV-DO MAC Codogram Measurement Procedure

MEASURE SETUP



- n **RESET/RESTART:** Restarts the measurement.
- n **AUTO SAVE:** Enables or disables automatic saving of the measurement data to an external USB memory. When it turns on, the measurements will be recorded into the default file “codogram.cod”.
- n **TIME CURSOR:** Enables or disables the time cursor indicator. When the time cursor is enabled after specifying a number, measurement is put on hold and information of the specific number is updated on the measurement screen.
- n **TIME INTERVAL:** Sets the time interval. Use the numeric keys to enter a value and press the **Enter** soft key or the **ENTER** hard key to complete to the input. 0 is the fastest measurement speed. As the time interval gets larger, the measurement speed is reduced.
- n **PN OFFSET:** Sets the PN Offset (Pseudo-Noise Offset) to **Auto** or **Manual**. Toggle between **Auto** and **Manual**. To change the value in the **Manual** mode, use the numeric keys and press the **Enter** soft key or the **ENTER** hard key to complete to the input.
- n **PN INCREMENT:** Sets the increment step for the PN Offset. Use the numeric keys to enter a value and press the **Enter** soft key or the **ENTER** hard key to complete to the input.
- n **TRHESHOLD:** Sets the threshold value between **Auto** and **Manual**. Its default setting is -27 dB. To change the value in the **Manual** mode, use the numeric keys to enter a value between -50 and 0 and press the **Enter** soft key or the **ENTER** hard key to complete to the input.
- n **MAC:** Selects the MAC Walsh code. Toggle between **64** and **128**.

Measurement Example

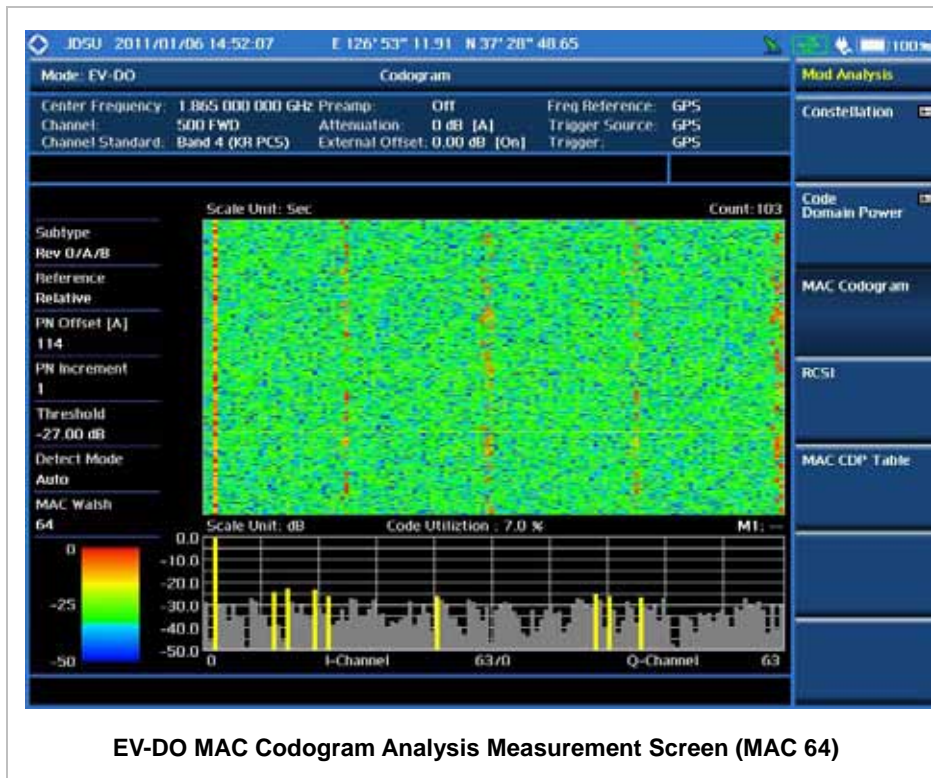

EV-DO MAC Codogram Analysis Measurement Screen (MAC 64)

The screen can display maximum 260 measurements at a time. When they become more than 260, new measurements are updated from the bottom of the display and old measurements disappear on the top of the display.

RCSI

The Received Code Strength Indicator (RCSI) is used to track the power variation over time of EV-DO channels: Pilot, MAC, Data, and Slot. The RCSI measurements can be saved into an external USB memory so that a post-analysis can be done with the application software JDViewer.

Measurement Procedure

| Step | Description |
|--|--|
| 1. Set the measurement mode MEASURE [Modulation Analysis] [RCSI] | Press the MEASURE hot key. Press the Modulation Analysis soft key. Press the RCSI soft key. |
| 2. Set the measurement parameters | |

| | |
|---|--|
| <p>MEASURE SETUP</p> <p>[PN Offset] <Auto> or <Manual> Enter a value [Enter]</p> <p>[PN Increment] Enter a value [Enter]</p> <p>[Threshold] Enter a value [dB]</p> <p>[MAC] <64> or <128></p> <p>[Alarm Code] [None], [Pilot], [MAC], [Data], or [Slot]</p> <p>[Set Mask] Enter a value [dBm]</p> <p>[Auto Save] <On> or <Off></p> | <p>Press the MEASURE SETUP hot key.</p> <p>Press the PN Offset soft key. The Auto mode is set by default. Toggle between Auto and Manual.</p> <p>Use the numeric keys to input value.</p> <p>Press the Enter soft key.</p> <p>Press the PN Increment soft key.</p> <p>Use the numeric keys to input value.</p> <p>Press the Enter soft key.</p> <p>Press the Threshold soft key.</p> <p>Use the numeric keys to input value.</p> <p>Press the unit soft key.</p> <p>Press the MAC soft key. Toggle between 64 and 128 to select the code.</p> <p>Press the Alarm Code soft key.</p> <p>Press one of the soft keys to select the alarm code.</p> <p>Press the Set Mask soft key.</p> <p>Use the numeric keys to input value.</p> <p>Press the unit soft key.</p> <p>Press the Auto Save soft key. Toggle between On and Off.</p> |
|---|--|

EV-DO RCSI Measurement Procedure

MEASURE SETUP



- n **RESET/RESTART:** Restarts the measurement.
- n **AUTO SAVE:** Enables or disables automatic saving of the measurement data to an external USB memory. When it turns on, the measurements will be recorded into the default file "rcsi.rcs".
- n **ALARM CODE:** Selects the alarm code among **None**, **Pilot**, **MAC**, **Data**, and **Slot**.
- n **SET MASK:** Sets the alarm mask value. Use the numeric keys to enter a value and press the unit soft key or the **ENTER** hard key to complete to the input.
- n **PN OFFSET:** Sets the PN Offset (Pseudo-Noise Offset) to **Auto** or **Manual**. Toggle between **Auto** and **Manual**. To change the value in the **Manual** mode, use the numeric keys and press the **Enter** soft key or the **ENTER** hard key to complete to the input.

- n **PN INCREMENT:** Sets the increment step for the PN Offset. Use the numeric keys to enter a value and press the **Enter** soft key or the **ENTER** hard key to complete to the input.
- n **TRHESHOLD:** Sets the threshold value between **Auto** and **Manual**. Its default setting is -27 dB. To change the value in the **Manual** mode, use the numeric keys to enter a value between -50 and 0 and press the **Enter** soft key or the **ENTER** hard key to complete to the input.
- n **MAC:** Selects the MAC Walsh code. Toggle between **64** and **128**.

Measurement Example

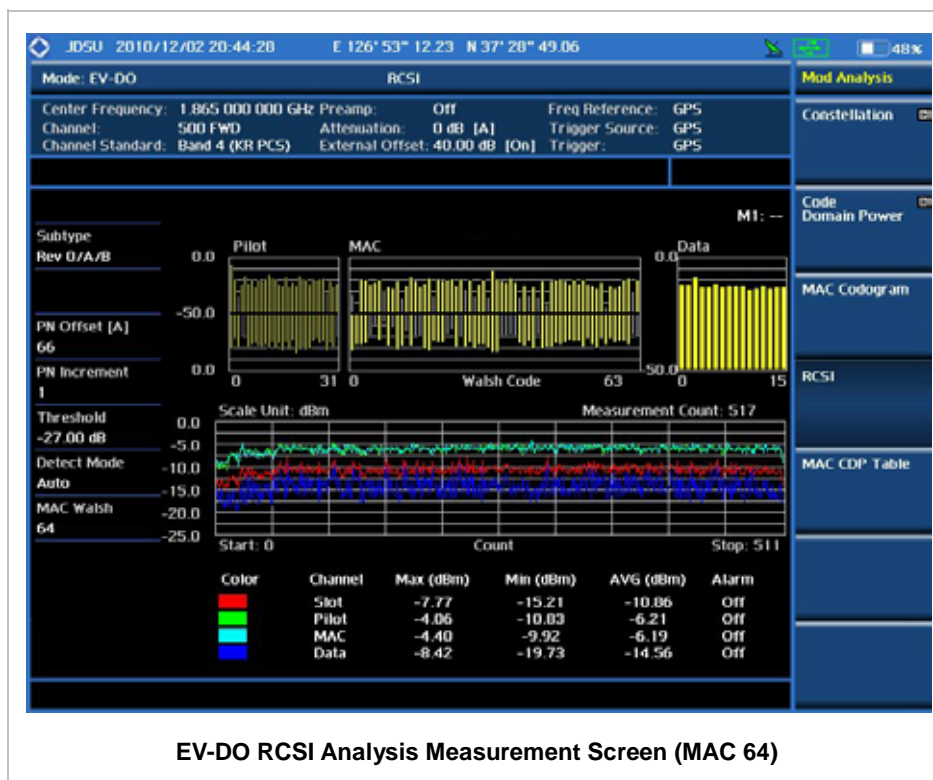

EV-DO RCSI Analysis Measurement Screen (MAC 64)

MAC CDP TABLE

The MAC CDP Table is used for the user to look at a numeric and textual description of all the active control channels in the signal.

Measurement Procedure

| Step | Description |
|---|---|
| 1. Set the measurement mode MEASURE [Modulation Analysis] [MAC CDP Table] | Press the MEASURE hot key. Press the Modulation Analysis soft key. Press the MAC CDP Table soft key. |
| 2. Set the measurement parameters MEASURE SETUP [PN Offset] <Auto> or <Manual> Enter a value [Enter] [PN Increment] Enter a value [Enter] [Threshold] Enter a value [dB] [MAC] <64> or <128> | Press the MEASURE SETUP hot key. Press the PN Offset soft key. The Auto mode is set by default. Toggle between Auto and Manual . Use the numeric keys to input value. Press the Enter soft key. Press the PN Increment soft key. Use the numeric keys to input value. Press the Enter soft key. Press the Threshold soft key. Use the numeric keys to input value. Press the unit soft key. Press the MAC soft key. Toggle between 64 and 128 to select the code. |

EV-DO MAC CDP Table Measurement Procedure

MEASURE SETUP



- n **PN OFFSET:** Sets the PN Offset (Pseudo-Noise Offset) to **Auto** or **Manual**. Toggle between **Auto** and **Manual**. To change the value in the **Manual** mode, use the numeric keys and press the **Enter** soft key or the **ENTER** hard key to complete to the input.
- n **PN INCREMENT:** Sets the increment step for the PN Offset. Use the numeric keys to enter a value and press the **Enter** soft key or the **ENTER** hard key to complete to the input.
- n **TRHESHOLD:** Sets the threshold value between Auto and Manual. Its default setting is -27 dB. To change the value in the **Manual** mode, use the numeric keys to enter a value between -50 and 0 and press the **Enter** soft key or the **ENTER** hard key to complete to the input.
- n **MAC:** Selects the MAC Walsh code. Toggle between **64** and **128**.

Measurement Example

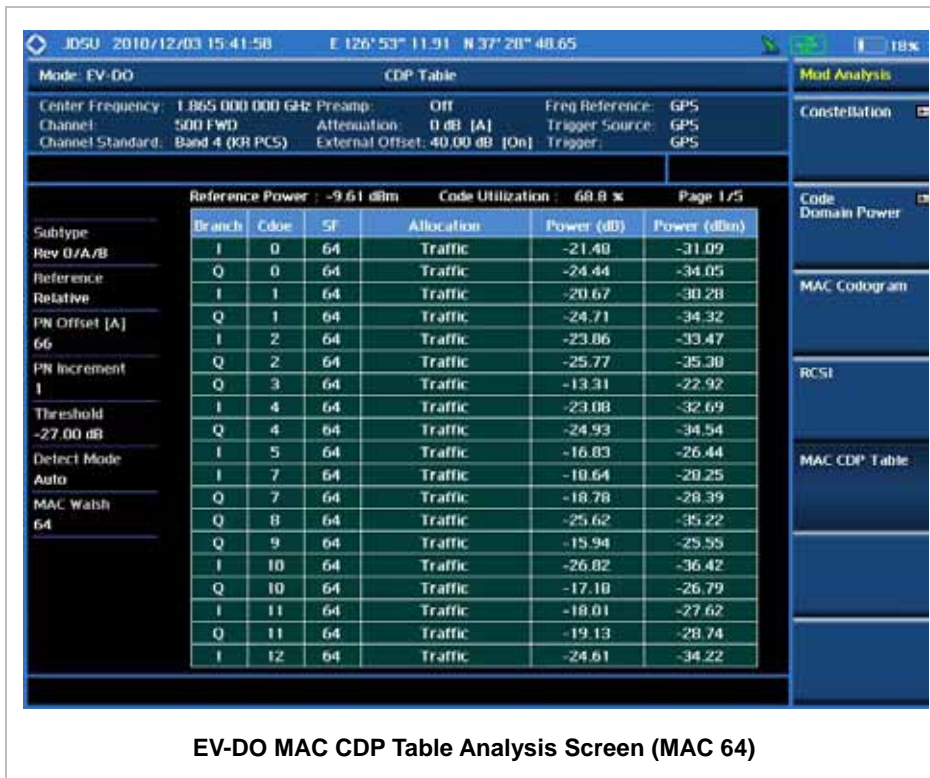

EV-DO MAC CDP Table Analysis Screen (MAC 64)

Setting Display

TRACE/DISPLAY



- n **PAGE UP:** Scrolls up the page to the previous screen.
- n **PAGE DOWN:** Scrolls down the page to the next screen.

AUTO MEASUREMENT

The Auto Measure function of the JD740A series allows a complete signal profiling covering RF characterization and modulation quality parameters of up to 10 different carriers, particularly useful on an overlay architecture where base stations are transmitting in different frequencies.

The Auto Measure can be easily executed either by selecting a menu in the instrument or by running a programmed scenario in the PC-based application so that the instrument automatically configure and perform tests on every aspect of all the carriers.

Setting Mode

| Step | Description |
|--|--|
| 1. Connect the cable | Connect a cable directly or indirectly as shown in the section Connecting a Cable on page 7 of this chapter. |
| 2. Select the mode MODE [Signal Analyzer] [EV-DO] [Auto Measure] | Press the MODE hard key. Press the Signal Analyzer soft key. Press the EV-DO soft key. Press the Auto Measure soft key. |

Following settings are required only when you run Auto Measure on the instrument using “Current” configuration setting. Additional settings are not required when you run Auto Measure using a scenario generated in the PC application software, JDViewer.

Setting Frequency

| Step | Description |
|---|--|
| 1. Set the frequency FREQ/DIST [Unit] <Freq> or <Channel> <i>When Freq is selected:</i> [Center Frequency] Enter a value [GHz], [MHz], [kHz], or [Hz] <i>When Channel is selected:</i> [Channel Standard] Select a channel standard [Select] or ENTER [Channel Number] Enter a value [Forward] | Press the FREQ/DIST hard key. Press the Unit soft key. Toggle this key between Freq and Channel . A set of Freq/Dist screen menu changes accordingly. Press the Center Frequency soft key. Use the numeric keys, the rotary knob, or the arrow keys. When using the numeric keys, the input is completed by selecting one of the unit soft keys. Press the Channel Standard soft key. Press the arrow keys, rotate the knob, or press the Page Up and Page Down soft keys to highlight a frequency band to select. Press the Select soft key or the ENTER hard key. Press the Channel Number soft key. Use the numeric keys to input value and press the Forward soft key to complete the input. The instrument automatically |

| | |
|--|---|
| | displays its corresponding center frequency value for the channel number. |
|--|---|

FREQ/DIST



- n **UNIT:** Determines the way how to set the frequency band either with standard band or custom frequency band. Toggling this key between **Freq** and **Channel** changes a set of Freq/Dist screen menu automatically.
- n **CENTER FREQUENCY:** Changes the center frequency setting. Use the rotary knob or the arrow keys. Or use the numeric keys to input a certain value and press one of the unit soft keys to complete the input.
- n **FREQUENCY STEP:** Defines the amount of frequency to be increased or decreased when using the rotary knob or the arrow keys to change the **Center Frequency**. This frequency step size can be entered by using numeric keys and the unit soft keys.
- n **CHANNEL NUMBER:** Enters a channel number. The instrument automatically displays its corresponding center frequency value for the channel number.
- n **CHANNEL STEP:** Defines the amount of channel to be increased or decreased when using the rotary knob or the arrow keys to change the **Channel Number**. This channel step size can be entered by using numeric keys and the **Enter** soft key.
- n **CHANNEL STANDARD:** When the channel standard is selected from the list, the center frequency information on the display screen will be mapped accordingly to the selected channel standard. The channel standards available in the instrument are listed in the Appendix C – Band, Frequency & Channel Standard.

Setting Trigger Source

TRIGGER



This hot key is used to select the trigger source among **Internal**, **External**, and **GPS**. The user input window must be inactive first to get the Trigger hot key function other than the number input.

Setting External Clock

To enhance the reliability of modulation analysis measurements the JD740A series must be synchronized with the Base Station. When an external clock is not supplied, the JD740A series works with a built-in internal high-accuracy time base. In this case, some measurement results may exhibit

inaccurate values. Therefore, it is highly recommended to use the same reference clock as signal source. Trigger mode can be changed by using the **TRIGGER** hot key.

EXTERNAL CLOCK OPERATING STANDARDS

| Clock | Type | Reference | Port | Switching Standard |
|--------------------|----------|--------------------|---------------|--|
| External Reference | Internal | Internal 10 MHz | | Default |
| | External | External Ref Clock | Ext Ref (SMA) | Manual switching (Input signal level >-3 dBm) |
| | GPS | GPS Clock | GPS (SMA) | Automatic switching (GPS signal received) |
| Trigger | Internal | Internal Trigger | | Default |
| | External | External Trigger | Trigger (SMA) | Manual switching |
| | GPS | GPS | GPS (SMA) | Manual switching |

CONNECTION

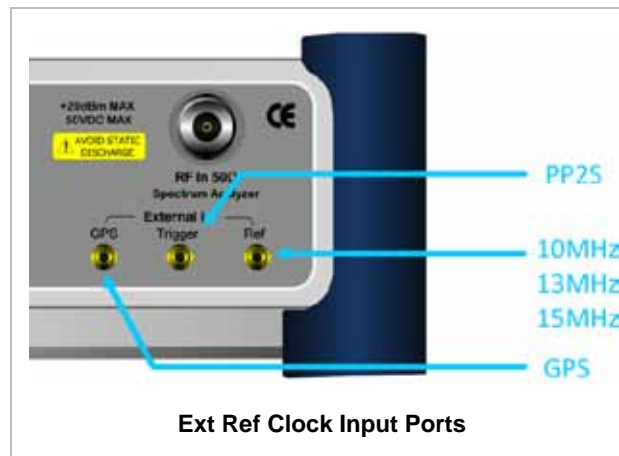

ENABLING EXTERNAL REFERENCE

| Step | Description |
|---|---|
| 1. Connect an external reference | Connect one of the external references or a GPS antenna to the JD740A series. |
| 2. Change reference clock SYSTEM [Frequency Reference] [External 10 MHz], | Press the SYSTEM hot key. Press the Frequency Reference soft key to select one of the external reference clocks or GPS. Press one of the soft keys to choose among External 10 MHz , |

| | |
|---|--|
| [External 13 MHz], [External 15 MHz] or [GPS] | External 13 MHz, External 15 MHz, and GPS. |
|---|--|

EXTERNAL REFERENCE INDICATOR INFORMATION

Each indicator tells different locking status according to a connection. When a GPS antenna is connected, longitude and latitude information will be displayed on the screen.

| Type | Indicator | Description |
|----------|--|----------------------------------|
| Internal |  (Green) | Locked |
| External |  (Green) | Locked |
| |  (Red) | Unlocked |
| GPS |  (Green) | Locked |
| |  (Yellow) | Locking in progress |
| |  (Gray) | Unable to lock or antenna failed |

Setting Limit



This hot key is used to set the threshold value for the limit line on the display screen. It turns on or off the limit or band limit settings of the measurement for pass/fail indication. The user input window must be inactive first to get the Limit hot key function other than the number input.

| Step | Description |
|---|---|
| 1. Set the RF test limit LIMIT [RF Test Limits] [Channel Power] [Test Limits] <On> or <Off> [High Limit] Enter a value [dBm] or ENTER [Low Limit] Enter a value [dBm] or ENTER | Press the LIMIT hot key. Press the RF Test Limits soft key. Press the Channel Power soft key. Press the Test Limits soft key to toggle between On and Off and select one. Press the High Limit soft key to set the upper limit of the Pass/Fail criteria. Use the numeric keys to input value. Press the unit soft key or the ENTER hard key. Press the Low Limit soft key to set the lower limit of the Pass/Fail criteria. Use the numeric keys to input value. Press the unit soft key or the ENTER hard key. |

| | |
|---|---|
| <p>[Occupied BW] [Test Limit] <On> or <Off> [High Limit] Enter a value [MHz], [kHz], or [Hz]</p> <p>[Spectrum Emission Mask] [Test Limit] <On> or <Off></p> <p>[ACPR] [Test Limit] <On> or <Off></p> <p>[Multi-ACPR] [Test Limit] <On> or <Off></p> <p>[Spurious Emissions] [Test Limit] <On> or <Off></p> | <p>Press the Occupied BW soft key. Press the Test Limit soft key to toggle between On and Off and select one. Press the High Limit soft key to set the upper limit of the Pass/Fail criteria. Use the numeric keys to input value. Press the unit soft key to select.</p> <p>Press the Spectrum Emission Mask soft key. Press the Test Limit soft key to toggle between On and Off and select one.</p> <p>Press the ACPR soft key. Press the Test Limit soft key to toggle between On and Off and select one.</p> <p>Press the Multi-ACPR soft key. Press the Test Limit soft key to toggle between On and Off and select one.</p> <p>Press the Spurious Emissions soft key. Press the Test Limit soft key to toggle between On and Off and select one.</p> |
| <p>2. Enable beep LIMIT [Beep] <On> or <Off></p> | <p>Press the LIMIT hot key. Press the Beep soft key to toggle between On and Off and select one. This will make audible alarm if the measurement result goes beyond the limit.</p> |

n **CHANNEL POWER:** Sets the test limit parameters.

Y **TEST LIMITS:** Enables or disables Pass/Fail results on the display screen. Toggle the **Test Limits** soft key to set it to **On** or **Off**.

Y **HIGH LIMIT:** Sets the upper limit of the Pass/Fail criteria. Use the numeric keys to enter a threshold or limit value and press the **dBm** unit soft key or the **ENTER** hard key to complete the input.

Y **LOW LIMIT:** Sets the lower limit of the Pass/Fail criteria. Use the numeric keys to enter a threshold or limit value and press the **dBm** unit soft key or the **ENTER** hard key to complete the input.

n **OCCUPIED BW:** Sets the test limit parameters.

Y **TEST LIMIT:** Enables or disables Pass/Fail results on the display screen. Toggle the **Test Limit** soft key to set it to **On** or **Off**.

- Y **HIGH LIMIT:** Sets the upper limit of the Pass/Fail criteria. Use the numeric keys to enter a threshold or limit value and press one of the unit soft keys to complete the input.
- n **SPECTRUM EMISSION MASK:** Sets the test limit parameter.
 - Y **TEST LIMIT:** Enables or disables Pass/Fail results on the display screen. Toggle the **Test Limit** soft key to set it to **On** or **Off**.
- n **ACPR:** Sets the test limit parameter.
 - Y **TEST LIMIT:** Enables or disables Pass/Fail results on the display screen. Toggle the **Test Limit** soft key to set it to **On** or **Off**.
- n **MULTI-ACPR:** Sets the test limit parameter.
 - Y **TEST LIMIT:** Enables or disables Pass/Fail results on the display screen. Toggle the **Test Limit** soft key to set it to **On** or **Off**.
- n **SPURIOUS EMISSIONS:** Sets the test limit parameter.
 - Y **TEST LIMIT:** Enables or disables Pass/Fail results on the display screen. Toggle the **Test Limit** soft key to set it to **On** or **Off**.

Measurement Procedure

| Step | Description |
|---|---|
| 1. Select the mode MEASURE [Auto Measure] | Press the MEASURE hot key. Press the Auto Measure soft key. |
| 2. Set the measurement parameters MEASURE SETUP [Configuration] <Current> or <Scenario> [Load Scenario] [Test Time] <Now> or <Schedule> [Set Timing] [Start Time (HH:MM)] Enter a value [HHMM] | Press the MEASURE SETUP hot key. Press the Configuration soft key to select the mode. Toggle this soft key between Current and Scenario . Press the Load Scenario soft key to load a scenario file. This key is active only when the Configuration is set to Scenario . Press the Test Time soft key to select when to run a test. Toggle this soft key between Now and Schedule . Press the Set Timing soft key. This key is activated only when the Test Time is set to Schedule. Press the Start Time soft key. Use the numeric keys to input value in HH:MM format. Press the HHMM soft key to complete the input. |

| | |
|---|--|
| <p>[Stop Time (HH:MM)] Enter a value [HHMM] [Time Interval] Enter a value [Min]</p> | <p>Press the Stop Time soft key. Use the numeric keys to input value in HH:MM format. Press the HHMM soft key to complete the input. Press the Time Interval soft key. Use the numeric keys to input value in minutes. Press the Min soft key to complete the input.</p> |
| <p>[Save Result] [File Name]</p> | <p>Press the Save Result soft key. Press the File Name soft key to assign a specific name to the test result.</p> |
| <p>[Save to] <Internal> or <USB></p> | <p>Press the Save to soft key to select where to save the test result. Toggle this soft key between Internal and USB.</p> |
| <p>[Save Screen] <All> or <Fail></p> | <p>Press the Save Screen soft key to choose the save option. Toggle this soft key between All and Fail. This key is activated only when the Save to is set to USB.</p> |
| <p>[Settings] [MAC] <64> or <128></p> | <p>Press the Settings soft key. Press the MAC soft key to select MAC Walsh code. Toggle this soft key between 64 and 128.</p> |
| <p>[PvsT] <Active> or <Idle></p> | <p>Press the PvsT soft key to select Power vs Time mode. Toggle this soft key between Active and Idle.</p> |
| <p>[Run Test]</p> | <p>Press the Run Test soft key to run a test.</p> |

EV-DO Auto Measurement Procedure

MEASURE SETUP



- n **RUN TEST:** Starts a test.
- n **CONFIGURATION:** Selects the measurement configuration to be used. When the **Current** is selected, the instrument runs a test using current carrier frequency (single carrier) and determines pass/fail based on the instrument's limit settings. Select the **Scenario** to run a test with a programmed scenario.
- n **LOAD SCENARIO:** Selects and loads a scenario file generated by the PC application software, JDViewer. This soft key is activated only when the **Configuration** is set to **Scenario**.
- n **TEST TIME:** Selects the test time. When **Now** is selected, the instrument runs a test only once. When **Schedule** is selected, the instrument repeats tests as defined in the **Set Timing** menu.
- n **SET TIMING:** Sets the **Start Time**, **Stop Time**, and **Time Interval** of a scheduled measurement. This soft key is activated only when the **Test Time** is set to **Schedule**.
- n **SAVE RESULT:** Sets parameters for saving measurement results. The instrument automatically saves measurement results in *.CSV format as well so that they can be imported in an application

software that supports the CSV format.

- Y **FILE NAME:** Sets the measurement result file name.
- Y **SAVE TO:** Sets the destination where the result to be saved, **Internal** or **USB**.
- Y **SAVE SCREEN:** Selects what results to be saved into a USB drive. Toggle this soft key between **All** for all the measurement items and **Fail** for failed items only. This key is activated only when the **Save to** is set to **USB**.
- n **SETTINGS:** Sets the MAC code and the time slot number.
 - Y **MAC:** Selects the MAC Walsh code. Toggle between **64** and **128**.
 - Y **PvsT:** Selects the Power vs Time mode. Toggle between **Active** and **Idle**.
 - Y **EXTERNAL OFFSET:** Sets an external offset value. An offset consists of a cable loss and a user offset and the measurement result shows the value reflecting both offset values. When the external offset value is set at 40 dB in the Spectrum mode, the measurement result compensates 40 dB at both the Spectrum Analyzer and Signal Analyzer modes.

Setting Display

TRACE/DISPLAY



- n **DISPLAY:** Changes the display option. After running automatic measurement, toggle this key between **Results** and **Settings**.
 - Y **RESULTS:** Shows actual measurement results on the display screen.
 - Y **SETTINGS:** Shows measurement parameters set for the automatic measurement.
- n **DISPLAY RESULTS:** Changes the display format of measurement results. This key becomes activated when the **Results** is set as the display option. Toggle this key between **Full** and **Quick** to check measurement results in different format.
 - Y **FULL:** Shows detailed measurement results, including actual measurement readings with pass/fail color indication.
 - Y **QUICK:** Shows quick view of pass/fail results.
- n **VIEW CARRIER:** Selects a carrier to be displayed among up to 10 carriers. This key becomes activated when the **Results** is set as the display option.

POWER STATISTICS CCDF

Power Statistics Complementary Cumulative Distribution Function (CCDF) measurement characterizes the power statistics of input signal. It provides PAR (Peak to Average power Ratio) versus different probabilities.

Setting Mode

| Step | Description |
|---|---|
| 1. Connect the cable | Connect a cable directly or indirectly as shown in the section Connecting a Cable on page 7 of this chapter. |
| 2. Select the mode MODE [Signal Analyzer] [EV-DO] [Power Statistics CCDF] | Press the MODE hard key. Press the Signal Analyzer soft key. Press the EV-DO soft key. Press the Power Statistics CCDF soft key. |

Setting Frequency

| Step | Description |
|--|---|
| 1. Set the frequency FREQ/DIST [Unit] <Freq> or <Channel> | Press the FREQ/DIST hard key. Press the Unit soft key. Toggle this key between Freq and Channel . A set of Freq/Dist screen menu changes accordingly. |
| <i>When Freq is selected:</i> [Center Frequency] Enter a value [GHz], [MHz], [kHz], or [Hz] | Press the Center Frequency soft key. Use the numeric keys, the rotary knob, or the arrow keys. When using the numeric keys, the input is completed by selecting one of the unit soft keys. |
| <i>When Channel is selected:</i> [Channel Standard] Select a channel standard [Select] or ENTER | Press the Channel Standard soft key to get the pop-up window of the channel standard list. Press the arrow keys, rotate the knob, or press the Page Up and Page Down soft keys to highlight a frequency band to select. Press the Select soft key or the ENTER hard key. |
| [Channel Number] Enter a value [Forward] | Press the Channel Number soft key. Use the numeric keys to input value and press the Forward soft key to complete the input. The instrument automatically |

| | |
|--|---|
| | displays its corresponding center frequency value for the channel number. |
|--|---|

FREQ/DIST 

- n **UNIT:** Determines the way how to set the frequency band either with standard band or custom frequency band. Toggling this key between **Freq** and **Channel** changes a set of Freq/Dist screen menu automatically.
- n **CENTER FREQUENCY:** Changes the center frequency setting. Use the rotary knob or the arrow keys. Or use the numeric keys to input a certain value and press one of the unit soft keys to complete the input.
- n **FREQUENCY STEP:** Defines the amount of frequency to be increased or decreased when using the rotary knob or the arrow keys to change the **Center Frequency**. This frequency step size can be entered by using numeric keys and the unit soft keys.
- n **CHANNEL NUMBER:** Enters a channel number. The instrument automatically displays its corresponding center frequency value for the channel number.
- n **CHANNEL STEP:** Defines the amount of channel to be increased or decreased when using the rotary knob or the arrow keys to change the **Channel Number**. This channel step size can be entered by using numeric keys and the **Enter** soft key.
- n **CHANNEL STANDARD:** When the channel standard is selected from the list, the center frequency information on the display screen will be mapped accordingly to the selected channel standard. The channel standards available in the instrument are listed in the Appendix C – Band, Frequency & Channel Standard.

Setting Amplitude

| Step | Description |
|---|--|
| 1. Set the reference/attenuation level AMP/SCALE [Auto Scale] | Press the AMP/SCALE hard key. Press the Auto Scale soft key to automatically set optimum levels of reference and attenuation. |
| or | |
| [Attenuation] <Manual> | Press the Attenuation soft key. The Auto mode is set by default. This key toggles between the Auto and Manual . Press the Attenuation soft key to highlight the Manual mode |

| | |
|----------------------------|--|
| Enter an attenuation value | and change the attenuation value to optimize S/N. Use the numeric keys or the rotary knob that changes in a 5 dB step. The attenuation setting range is 0 to 50 dB. |
|----------------------------|--|

AMP/SCALE 

- n **AUTO SCALE:** The instrument can automatically set the scale to the minimum and maximum values on the Y-axis of the graph for optimum display of the traces measured. Each time the **Auto Scale** is selected, the top and bottom scales are set to the minimum and maximum values with margin on the Y-axis of the display screen.
- n **ATTENUATION**
 - Y **AUTO:** Input attenuator's value is automatically set depending on the reference level. This is the default operation mode, so it is recommended to use this mode unless a special measurement condition is needed.
 - Y **MANUAL:** Sets the attenuator's value for the **Spectrum Analyzer RF In 50 Ω** port.

Setting Sweep Mode

SWEEP 

This hot key is used to set the sweep parameters. The user input window must be inactive first to get the Sweep hot key function other than the number input.

- n **SWEEP MODE:** Sets the sweep method. Toggle between **Continue** and **Single**.

| Step | Description |
|--|---|
| 1. Set the sweep mode SWEEP [Sweep Mode] | Press the SWEEP hot key. Press the Sweep Mode soft key. Toggle between Continue and Single . |

Setting Trigger Source

TRIGGER 

This hot key is used to select the trigger source among **Internal**, **External**, and **GPS**. The user input window must be inactive first to get the Trigger hot key function other than the number input.

Setting External Clock

To enhance the reliability of modulation analysis measurements the JD740A series must be synchronized with the Base Station. When an external clock is not supplied, the JD740A series works with a built-in internal high-accuracy time base. In this case, some measurement results may exhibit inaccurate values. Therefore, it is highly recommended to use the same reference clock as signal source. Trigger mode can be changed by using the **TRIGGER** hot key.

EXTERNAL CLOCK OPERATING STANDARDS

| Clock | Type | Reference | Port | Switching Standard |
|--------------------|----------|--------------------|---------------|--|
| External Reference | Internal | Internal 10 MHz | | Default |
| | External | External Ref Clock | Ext Ref (SMA) | Manual switching (Input signal level >-3 dBm) |
| | GPS | GPS Clock | GPS (SMA) | Automatic switching (GPS signal received) |
| Trigger | Internal | Internal Trigger | | Default |
| | External | External Trigger | Trigger (SMA) | Manual switching |
| | GPS | GPS | GPS (SMA) | Manual switching |

CONNECTION

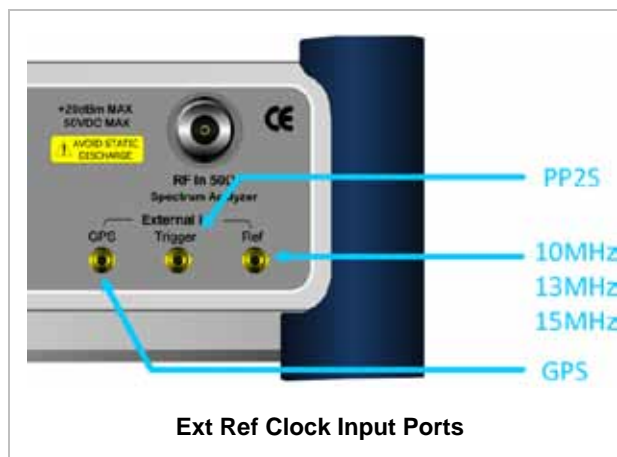

ENABLING EXTERNAL REFERENCE

| Step | Description |
|----------------------------------|---|
| 1. Connect an external reference | Connect one of the external references or a GPS antenna to the JD740A series. |

| | |
|---|---|
| <p>2. Change reference clock SYSTEM [Frequency Reference] [External 10 MHz], [External 13 MHz], [External 15 MHz] or [GPS]</p> | <p>Press the SYSTEM hot key. Press the Frequency Reference soft key to select one of the external reference clocks or GPS. Press one of the soft keys to choose among External 10 MHz, External 13 MHz, External 15 MHz, and GPS.</p> |
|---|---|

EXTERNAL REFERENCE INDICATOR INFORMATION

Each indicator tells different locking status according to a connection. When a GPS antenna is connected, longitude and latitude information will be displayed on the screen.

| Type | Indicator | Description |
|----------|--|----------------------------------|
| Internal |  (Green) | Locked |
| External |  (Green) | Locked |
| |  (Red) | Unlocked |
| GPS |  (Green) | Locked |
| |  (Yellow) | Locking in progress |
| |  (Gray) | Unable to lock or antenna failed |

Measurement Procedure

| Step | Description |
|---|--|
| <p>1. Set the measurement parameters MEASURE SETUP [CCDF Length] Enter a value [Enter]</p> | <p>Press the MEASURE SETUP hot key. Press the CCDF Length soft key. Use the numeric keys to input value. Press the Enter soft key.</p> |

EV-DO Power Statistics CCDF Measurement Procedure

MEASURE SETUP

- n **CCDF LENGTH:** Sets the length of the CCDF which is the number of measurements to be averaged. To change the value, use the numeric keys and press the **Enter** soft key or the **ENTER** hard key to complete to the input (value range 1 to 100).

Measurement Example



EV-DO OTA MEASUREMENTS

This Over The Air (OTA) measurement has channel scanner, PN scanner, multipath profile, and code domain power screens. It is used to verify EV-DO transmitter performance at any location providing reflective measurements and identifying signals providing from different sites.

EV-DO OTA Measurements provide the following essential measurements.

- n Channel Scanner
- n PN Scanner
- n Multipath Profile
- n Code Domain Power
- n Route Map

Setting Mode

Connecting a GPS antenna with the instrument is a mandatory for the OTA measurements.

| Step | Description |
|---|---|
| 1. Connect the antenna | Connect antennas as shown in the Connecting a Cable on page 8 of this chapter. |
| 2. Select the mode MODE [Signal Analyzer] [EV-DO] [OTA] [Channel Scanner], [PN Scanner], [Multipath Profile], [Code Domain Power], or [Route Map] | Press the MODE hard key. Press the Signal Analyzer soft key. Press the EV-DO soft key. Press the OTA soft key. Press one of the measurement mode soft keys to select. |

Setting Frequency

Setting frequency described here is not applicable to the OTA Channel Scanner mode. For the OTA Channel Scanner mode, refer to its measurement procedure.

| Step | Description |
|---|--|
| 1. Set the frequency FREQ/DIST [Unit] <Freq> or <Channel> <i>When Freq is selected:</i> [Center Frequency] Enter a value [GHz], [MHz], [kHz], or [Hz] <i>When Channel is selected:</i> [Channel Standard] Select a channel standard [Select] or ENTER | Press the FREQ/DIST hard key. Press the Unit soft key. Toggle this key between Freq and Channel . A set of Freq/Dist screen menu changes accordingly. Press the Center Frequency soft key. Use the numeric keys, the rotary knob, or the arrow keys. When using the numeric keys, the input is completed by selecting one of the unit soft keys. Press the Channel Standard soft key. Press the arrow keys, rotate the knob, or press the Page Up and Page Down soft keys to highlight a frequency band to select. Press the Select soft key or the ENTER hard key. |

| | |
|---|--|
| <p>[Channel Number] Enter a value [Forward]</p> | <p>Press the Channel Number soft key. Use the numeric keys to input value and press the Forward soft key to complete the input. The instrument automatically displays its corresponding center frequency value for the channel number.</p> |
|---|--|

FREQ/DIST



- n **UNIT:** Determines the way how to set the frequency band either with standard band or custom frequency band. Toggling this key between **Freq** and **Channel** changes a set of Freq/Dist screen menu automatically.
- n **CENTER FREQUENCY:** Changes the center frequency setting. Use the rotary knob or the arrow keys. Or use the numeric keys to input a certain value and press one of the unit soft keys to complete the input.
- n **FREQUENCY STEP:** Defines the amount of frequency to be increased or decreased when using the rotary knob or the arrow keys to change the **Center Frequency**. This frequency step size can be entered by using numeric keys and the unit soft keys.
- n **CHANNEL NUMBER:** Enters a channel number. The instrument automatically displays its corresponding center frequency value for the channel number.
- n **CHANNEL STEP:** Defines the amount of channel to be increased or decreased when using the rotary knob or the arrow keys to change the **Channel Number**. This channel step size can be entered by using numeric keys and the **Enter** soft key.
- n **CHANNEL STANDARD:** When the channel standard is selected from the list, the center frequency information on the display screen will be mapped accordingly to the selected channel standard. The channel standards available in the instrument are listed in the Appendix C – Band, Frequency & Channel Standard.

Setting Amplitude

| Step | Description |
|--|--|
| <p>1. Set the reference/attenuation level AMP/SCALE [Auto Scale] or</p> | <p>Press the AMP/SCALE hard key. Press the Auto Scale soft key to automatically set optimum levels of reference and attenuation.</p> |

| | |
|--|---|
| <p>[Reference Level] Enter a reference level value</p> | <p>Press the Reference Level soft key to set manually. Use the numeric keys or the rotary knob that changes in a 10 dB step.</p> |
| <p>[dBm] or ENTER</p> | <p>Press the dBm soft key or the ENTER hard key.</p> |
| <p>[Attenuation] <Manual> Enter an attenuation value</p> | <p>Press the Attenuation soft key. The Auto mode is set by default. This key toggles between the Auto and Manual. Press the Attenuation soft key to highlight the Manual mode and change the attenuation value to optimize S/N. Use the numeric keys or the rotary knob that changes in a 5 dB step. The attenuation setting range is 0 to 50 dB.</p> |

AMP/SCALE



- n **AUTO SCALE:** The instrument can automatically set the scale to the minimum and maximum values on the Y-axis of the graph for optimum display of the traces measured. Each time the **Auto Scale** is selected, the top and bottom scales are set to the minimum and maximum values with margin on the Y-axis of the display screen.
- n **REFERENCE:** Sets the display of measurement result to relative or absolute value. Toggle between **Abs** for absolute and **Rel** for relative. *This key is used in the OTA Code Domain Power mode and the Route Map mode.*
 - Y **ABS:** The code domain power is measured absolute to channel power.
 - Y **REL:** The code domain power is measured relative to channel power.
- n **REFERENCE LEVEL:** Sets the maximum Y-axis range. In the OTA Code Domain Power mode, this key is activated only when the **Reference** is set to absolute mode. *This key is used in the OTA Channel Scanner mode and the OTA Code Domain Power mode.*
- n **ATTENUATION**
 - Y **AUTO:** Input attenuator's value is automatically set depending on the reference level. This is the default operation mode, so it is recommended to use this mode unless a special measurement condition is needed.
 - Y **MANUAL:** Sets the attenuator's value for the **Spectrum Analyzer RF In 50 Ω** port.
- n **PREAMP:** Turns on or off the internal pre-amplifier. Preamp results in a correction being applied to compensate for the gain of the preamp so that amplitude readings show the value at the input connector. This soft key toggles between the **On** and **Off**. When it is set to On, the allowable attenuation input range is from 0 dB to 10 dB in a multiple of 5. If the attenuation value is manually set greater than 10 dB, the instrument will automatically turn off the pre-amplifier to display low level signal properly on the screen.
- n **EXTERNAL OFFSET:** Sets an external offset value. An offset consists of a cable loss and a user

offset and the measurement result shows the value reflecting both offset values. When the external offset value is set at 40 dB in the Spectrum mode, the measurement result compensates 40 dB at both the Spectrum Analyzer and Signal Analyzer modes.

Setting Sweep Mode

SWEEP



This hot key is used to set the sweep parameters. The user input window must be inactive first to get the Sweep hot key function other than the number input.

- n **SWEEP MODE:** Sets the sweep method. Toggle between **Continue** and **Single**.

| Step | Description |
|---|---|
| 1. Set the sweep mode SWEEP [Sweep Mode] | Press the SWEEP hot key. Press the Sweep Mode soft key. Toggle between Continue and Single . |

Setting Trigger Source

TRIGGER



This hot key is used to select the trigger source among **Internal**, **External**, and **GPS**. The user input window must be inactive first to get the Trigger hot key function other than the number input. For OTA measurement, a GPS antenna should be connected and the trigger source should be set to **GPS**.

Setting External Clock

To enhance the reliability of modulation analysis measurements the JD740A series must be synchronized with the Base Station. When an external clock is not supplied, the JD740A series works with a built-in internal high-accuracy time base. In this case, some measurement results may exhibit inaccurate values. Therefore, it is highly recommended to use the same reference clock as signal source. Trigger mode can be changed by using the **TRIGGER** hot key.

EXTERNAL CLOCK OPERATING STANDARDS

| Clock | Type | Reference | Port | Switching Standard |
|----------|----------|-----------------|------|--------------------|
| External | Internal | Internal 10 MHz | | Default |

| | | | | |
|-----------|----------|--------------------|---------------|--|
| Reference | External | External Ref Clock | Ext Ref (SMA) | Manual switching (Input signal level >-3 dBm) |
| | GPS | GPS Clock | GPS (SMA) | Automatic switching (GPS signal received) |
| Trigger | Internal | Internal Trigger | | Default |
| | External | External Trigger | Trigger (SMA) | Manual switching |
| | GPS | GPS | GPS (SMA) | Manual switching |

CONNECTION

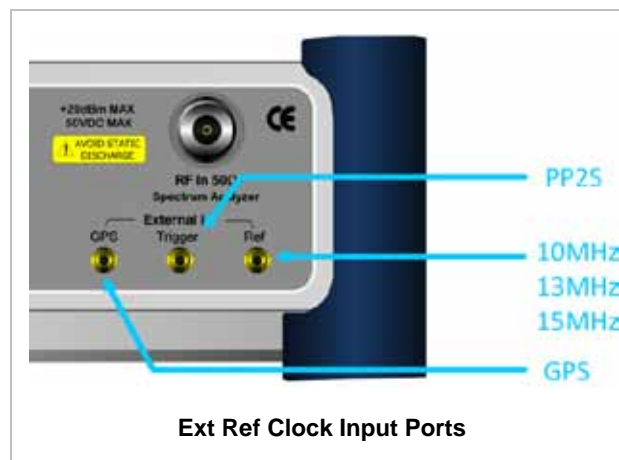



ENABLING GPS EXTERNAL REFERENCE

| Step | Description |
|--|--|
| 1. Connect a GPS antenna | Connect a GPS antenna to the JD740A series. |
| 2. Change reference clock SYSTEM [Frequency Reference] [GPS] | Press the SYSTEM hot key. Press the Frequency Reference soft key. Press the GPS soft key to perform OTA measurements. |

GPS EXTERNAL REFERENCE INDICATOR INFORMATION

When a GPS antenna is connected, the instrument automatically detects it. Each indicator tells different locking status depending on its connection. If it is successfully locked, the instrument will display "GPS" and longitude and latitude information on the screen. If it is unlocked or the antenna is disconnected, the display will be automatically switched to "Internal".

| Type | Indicator | Description |
|------|--|----------------------------------|
| GPS |  (Green) | Locked |
| |  (Yellow) | Locking in progress |
| |  (Gray) | Unable to lock or antenna failed |

EV-DO OTA CHANNEL SCANNER

Measurement Procedure

| Step | Description |
|--|---|
| <p>1. Set the measurement mode</p> <p>MEASURE</p> <p>[OTA]</p> <p>[Channel Scanner]</p> | <p>Press the MEASURE hot key.</p> <p>Press the OTA soft key.</p> <p>Press the Channel Scanner soft key.</p> |
| <p>2. Set the frequency</p> <p>FREQ/DIST</p> <p>[Edit List]</p> <p>[Add]</p> <p>or</p> <p>[Delete]</p> | <p>Press the FREQ/DIST hard key.</p> <p>Press the Edit List soft key to add, delete, or edit the list of channels to be scanned and a list of channels will pop up.</p> <p>Press the Add soft key to add a channel to the list. To change a channel standard, use the rotary knob to highlight the channel standard and then press the center of the rotary knob or the ENTER hard key. In the band list pop-up window, use the rotary knob or the arrow keys to highlight a channel band and then press the center of the rotary knob or the ENTER hard key. To change the channel number or frequency, use the rotary knob to highlight the channel number or the frequency and then press the center of the rotary knob or the ENTER hard key. Use numeric keys to enter a value and then press the ENTER hard key to complete the entry.</p> <p>In the Edit List window, use the rotary knob or the arrow keys to highlight a channel to delete and then press the Delete hard key.</p> |

| | |
|--|---|
| <p>3. Set the reference/attenuation level AMP/SCALE [Auto Scale]</p> | <p>Press the AMP/SCALE hard key. Press the Auto Scale soft key to automatically set optimum levels of reference and attenuation. Do this setting after measuring all the selected channels to have optimized reference level and attenuation level.</p> |
| <p>4. Set the measurement parameters MEASURE SETUP [PN Increment] Enter a value [Enter]</p> | <p>Press the MEASURE SETUP hot key. Press the PN Increment soft key. Use the numeric keys to input value. Press the Enter soft key.</p> |

EV-DO OTA Channel Scanner Measurement Procedure

FREQ/DIST 

- n **EDIT LIST:** Adds new channel(s) to be measured or deletes or edits existing channel standard(s) in the pop-up list window.

MEASURE SETUP 

- n **PN INCREMENT:** Sets the increment step for the PN Offset. Use the numeric keys to enter a value and press the **Enter** soft key or the **ENTER** hard key to complete to the input.

Setting Limit

LIMIT 

This hot key is used to set the threshold value for the limit line on the display screen. It turns on or off the limit or band limit settings of the measurement for pass/fail indication. The user input window must be inactive first to get the Limit hot key function other than the number input.

| Step | Description |
|---|---|
| <p>1. Select the limit line LIMIT [Limit Line] <On> or <Off> Enter a value [dBm] or ENTER</p> | <p>Press the LIMIT hot key. Press the Limit Line soft key to toggle between On and Off. This will enable or disable the limit line on the display screen. Use the numeric keys to input value. Press the dBm unit soft key or the ENTER hard key.</p> |

- n **LIMIT LINE:** Enables or disables the test limit. Toggle the **Limit Line** soft key between **On** and **Off**. When the display line is set to on, use the numeric keys to enter a limit value and then press the **dBm** unit soft key or the **ENTER** hard key.

Measurement Example

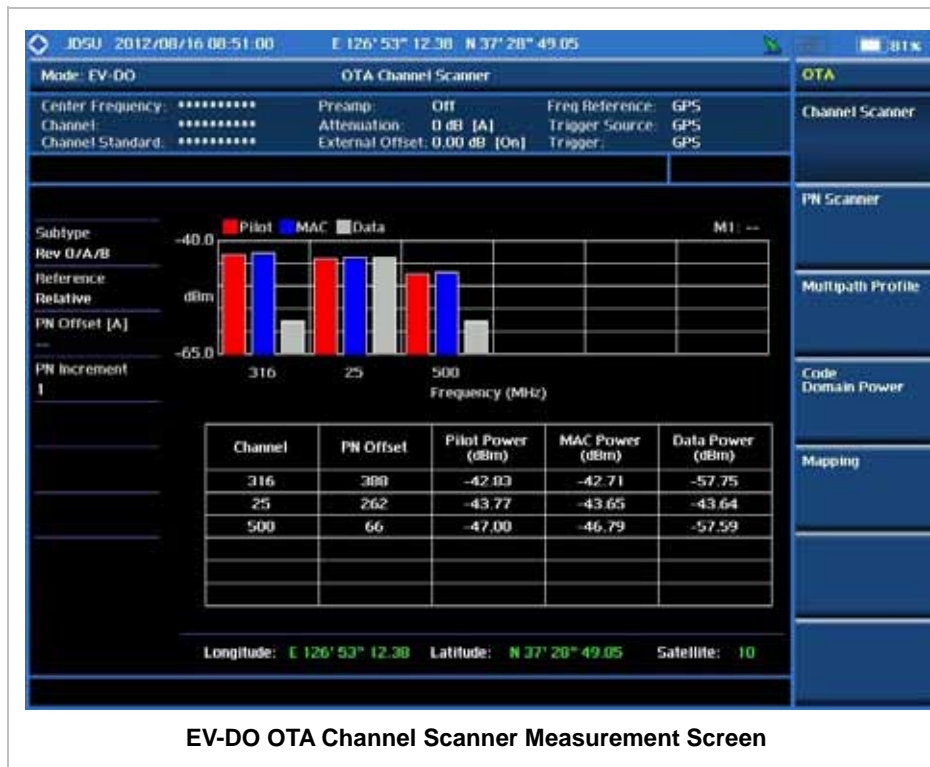

EV-DO OTA PN SCANNER

Each access network sector has a unique PN offset. The PN Scanner is used to identify all active PNs in the area.

Measurement Procedure

| Step | Description |
|---|---|
| 1. Set the measurement mode MEASURE [OTA] | Press the MEASURE hot key. Press the OTA soft key. |

| | |
|---|---|
| <p>[PN Scanner]</p> | <p>Press the PN Scanner soft key.</p> |
| <p>2. Set the measurement parameters</p> <p>MEASURE SETUP</p> <p>[PN Increment]</p> <p>Enter a value</p> <p>[Enter]</p> <p>[Auto Save]</p> <p><On> or <Off></p> | <p>Press the MEASURE SETUP hot key.</p> <p>Press the PN Increment soft key.</p> <p>Use the numeric keys to input value.</p> <p>Press the Enter soft key.</p> <p>Press the Auto Save soft key. Toggle between On and Off.</p> |

EV-DO OTA PN Scanner Measurement Procedure

MEASURE SETUP



- n **PN INCREMENT:** Sets the increment step for the PN Offset. Use the numeric keys to enter a value and press the **Enter** soft key or the **ENTER** hard key to complete to the input.
- n **AUTO SAVE:** Enables or disables automatic saving of the measurement data to an external USB memory. When it turns on, the measurements will be recorded into the default file (logging.ota) or a user-named file.

Measurement Example



EV-DO OTA PN Scanner Measurement Screen

EV-DO OTA MULTIPATH PROFILE

The Multipath Profile enables the user to determine RF environmental conditions of testing area. It indicates the amount of power of the dominant pilot signal that is dispersed outside the main correlation peak due to multipath echoes that are expressed in dB. This value should be very small ideally.

The multipath profile is the result of portions of the original broadcast signal arriving at the receiving antenna out of phase. This can be caused by the signal being reflected off objects such as buildings, or being refracted through the atmosphere differently from the main signal.

Measurement Procedure

| Step | Description |
|---|--|
| 1. Set the measurement mode MEASURE [OTA] [Multipath Profile] | Press the MEASURE hot key. Press the OTA soft key. Press the Multipath Profile soft key. |
| 2. Set the measurement parameters MEASURE SETUP [PN Increment] Enter a value [Enter] | Press the MEASURE SETUP hot key. Press the PN Increment soft key. Use the numeric keys to input value. Press the Enter soft key. |

EV-DO OTA Multipath Profile Measurement Procedure

MEASURE SETUP



- n **PN INCREMENT:** Sets the increment step for the PN Offset. Use the numeric keys to enter a value and press the **Enter** soft key or the **ENTER** hard key to complete to the input.

Measurement Example

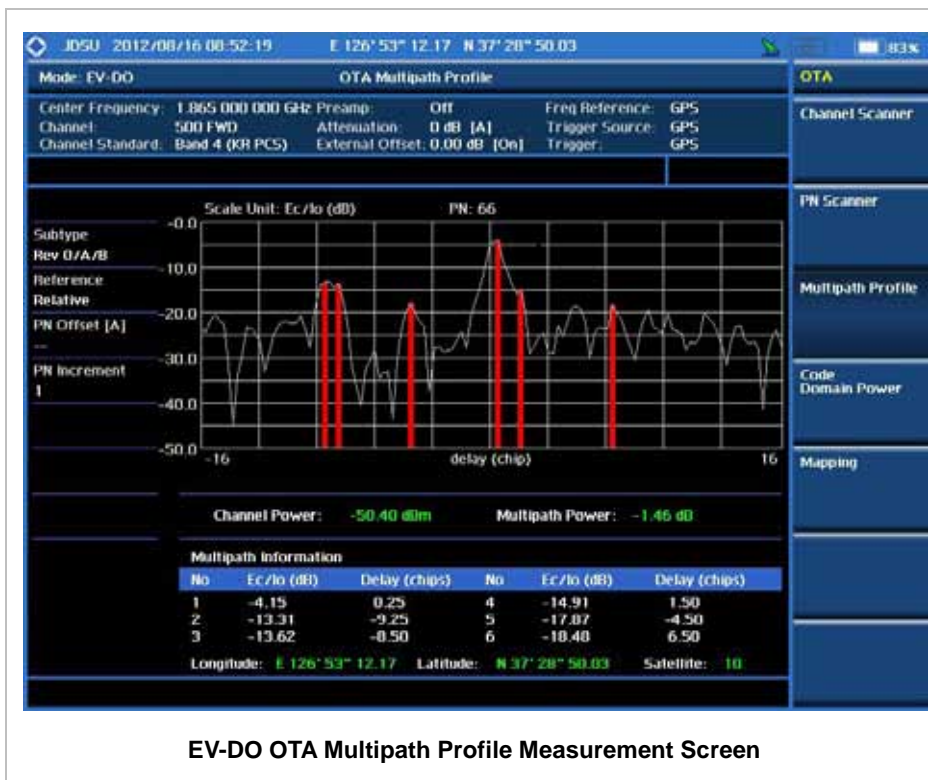

EV-DO OTA Multipath Profile Measurement Screen

EV-DO OTA CODE DOMAIN POWER

Channels with high correlation factors are determined to be active channels and are indicated as such on the display. Once the channels are decoded, the analyzer determines the power of each channel relative to the total signal power.

This measurement helps to verify that each code channel is operating at its proper level and helps to identify problems throughout the transmitter design from the coding to the RF section. System imperfections, such as the non-linearity of amplifiers, will present themselves as an undesired distribution of power in the code domain.

Measurement Procedure

| Step | Description |
|---|---|
| 1. Set the measurement mode MEASURE [OTA] [Code Domain Power] | Press the MEASURE hot key. Press the OTA soft key. Press the Code Domain Power soft key. |

2. Set the measurement parameters

MEASURE SETUP**[PN Offset]**

<Auto> or <Manual>

Enter a value

[Enter]**[PN Increment]**

Enter a value

[Enter]**[Threshold]**

Enter a value

[dB]**[MAC Walsh]**

<64> or <128>

[Detect Mode]**[Auto]**, **[QPSK]**, **[8PSK]**,**[16QAM]**, or **[64QAM]****[Pilot Dominance >]**

Enter a value

[dB]**[Multipath Power <]**

Enter a value

[dB]**[Auto Save]**

<On> or <Off>

Press the **MEASURE SETUP** hot key.Press the **PN Offset** soft key. The **Auto** mode is set by default. Toggle between **Auto** and **Manual**.

Use the numeric keys to input value.

Press the **Enter** soft key.Press the **PN Increment** soft key.

Use the numeric keys to input value.

Press the **Enter** soft key.Press the **Threshold** soft key.

Use the numeric keys to input value.

Press the unit soft key.

Press the **MAC Walsh** soft key. Toggle between **64** and **128** to select the code.Press the **Detect Mode** soft key.

Press one of the soft keys to select the detection mode.

Press the **Pilot Dominance >** soft key.

Use the numeric keys to input value. 10 is recommended.

Press the unit soft key.

Press the **Multipath Power <** soft key.

Use the numeric keys to input value. 1 is recommended.

Press the unit soft key.

Press the **Auto Save** soft key. Toggle between **On** and **Off**.**EV-DO OTA Code Domain Power Measurement Procedure****MEASURE SETUP**

- n **PN OFFSET:** Sets the PN Offset (Pseudo-Noise Offset) to **Auto** or **Manual**. Toggle between **Auto** and **Manual**. To change the value in the **Manual** mode, use the numeric keys and press the **Enter** soft key or the **ENTER** hard key to complete to the input.
- n **PN INCREMENT:** Sets the increment step for the PN Offset. Use the numeric keys to enter a value and press the **Enter** soft key or the **ENTER** hard key to complete to the input.
- n **TRHESHOLD:** Sets the threshold value between Auto and Manual. Its default setting is -27 dB. To

change the value in the **Manual** mode, use the numeric keys to enter a value between -50 and 0 and press the **Enter** soft key or the **ENTER** hard key to complete to the input.

- n **MAC WALSH:** Selects the MAC Walsh code. Toggle between **64** and **128**.
- n **PILOT DOMINANCE >:** Sets the threshold for pilot dominance. 10 is recommended. Color of the Pilot Dominance indicator on the left bottom corner of the screen is based on this set value.
- n **MULTIPATH POWER <:** Sets the threshold for multipath power. 1 is recommended. Color of the Multipath Power indicator on the left bottom corner of the screen is based on this set value.
- n **AUTO SAVE:** Enables or disables automatic saving of the measurement data to an external USB memory. When it turns on, the measurements will be recorded into the default file (logging.ota) or a user-named file.

Setting Limit



This hot key is used to set the threshold value for the limit line on the display screen. It turns on or off the limit or band limit settings of the measurement for pass/fail indication. The user input window must be inactive first to get the Limit hot key function other than the number input.

| Step | Description |
|--|--|
| 1. Select the limit LIMIT [Modulation Test Limits] [Frequency Error] [Test Limits] <On> or <Off> [High Limit] [Low Limit] [Time Offset] [Test Limits] <On> or <Off> [High Limit] [Low Limit] [Carrier Feed Through] [Test Limit] <On> or <Off> [High Limit] | Press the LIMIT hot key. Press the Modulation Test Limits soft key. Press the Frequency Error soft key. Press the Test Limits soft key. Toggle between On and Off . Use the numeric keys and input a number in ppm. Use the numeric keys and input a number in ppm. Press the Time Offset soft key. Press the Test Limits soft key. Toggle between On and Off . Use the numeric keys and input a number in us. Use the numeric keys and input a number in us. Press the Carrier Feed Through soft key. Press the Test Limit soft key. Toggle between On and Off . Use the numeric keys and input a number in dB. |

| | |
|---|--|
| <p>[Pilot Rho] [Test Limit] <On> or <Off> [Low Limit]</p> <p>[MAC Rho] [Test Limit] <On> or <Off> [Low Limit]</p> <p>[Data Rho] [Test Limit] <On> or <Off> [Low Limit]</p> | <p>Press the Pilot Rho soft key.</p> <p>Press the Test Limit soft key. Toggle between On and Off.</p> <p>Use the numeric keys and input a number.</p> <p>Press the MAC Rho soft key.</p> <p>Press the Test Limit soft key. Toggle between On and Off.</p> <p>Use the numeric keys and input a number.</p> <p>Press the Data Rho soft key.</p> <p>Press the Test Limit soft key. Toggle between On and Off.</p> <p>Use the numeric keys and input a number.</p> |
| <p>2. Enable beep LIMIT [Beep] <On> or <Off></p> | <p>Press the LIMIT hot key.</p> <p>Press the Beep soft key to toggle between On and Off and select one. This will make audible alarm if the measurement result goes beyond the limit.</p> |

- n **FREQUENCY ERROR:** Sets the frequency error limit.
- Y **TEST LIMITS:** Enables or disables the test limits. Toggle the **Test Limits** soft key between **On** and **Off**.
- Y **HIGH LIMIT:** Sets the upper limit. Use the numeric keys to input value and press the unit soft key or the **ENTER** hard key to complete the input.
- Y **LOW LIMIT:** Sets the lower limit. Use the numeric keys to input value and press the unit soft key or the **ENTER** hard key to complete the input.
- n **TIME OFFSET:** Sets the time offset limit. Time Offset compares the PN offset timing with the overall system time and the instrument checks the start of PN offset in comparison to either the GPS signal or the even second clock signal.
- Y **TEST LIMITS:** Enables or disables the test limits. Toggle the **Test Limits** soft key between **On** and **Off**.
- Y **HIGH LIMIT:** Sets the upper limit. Use the numeric keys to input value and press the unit soft key or the **ENTER** hard key to complete the input.
- Y **LOW LIMIT:** Sets the lower limit. Use the numeric keys to input value and press the unit soft key or the **ENTER** hard key to complete the input.
- n **CARRIER FEED THROUGH:** Sets the limit of carrier feed through. Carrier Feed Through is a result of the RF carrier signal feeding through the I/Q modulator and riding on the output circuitry

without being modulated. It sets the limit of carrier feed through.

- Y **TEST LIMIT:** Enables or disables the test limit. Toggle the **Test Limit** soft key between **On** and **Off**.
- Y **HIGH LIMIT:** Sets the upper limit. Use the numeric keys to input value and press the unit soft key or the **ENTER** hard key to complete the input.
- n **MAX INACTIVE:** *This key is not used in this OTA Code Domain Power mode.*
- n **PILOT RHO:** Sets the Pilot Rho limit.
 - Y **TEST LIMIT:** Enables or disables the test limit. Toggle the **Test Limit** soft key between **On** and **Off**.
 - Y **LOW LIMIT:** Sets the lower limit. Use the numeric keys to input value and press the unit soft key or the **ENTER** hard key to complete the input.
- n **MAC RHO:** Sets the MAC Rho limit.
 - Y **TEST LIMIT:** Enables or disables the test limit. Toggle the **Test Limit** soft key between **On** and **Off**.
 - Y **LOW LIMIT:** Sets the lower limit. Use the numeric keys to input value and press the unit soft key or the **ENTER** hard key to complete the input.
- n **DATA RHO:** Sets the Data Rho limit.
 - Y **TEST LIMIT:** Enables or disables the test limit. Toggle the **Test Limit** soft key between **On** and **Off**.
 - Y **LOW LIMIT:** Sets the lower limit. Use the numeric keys to input value and press the unit soft key or the **ENTER** hard key to complete the input.

Measurement Example

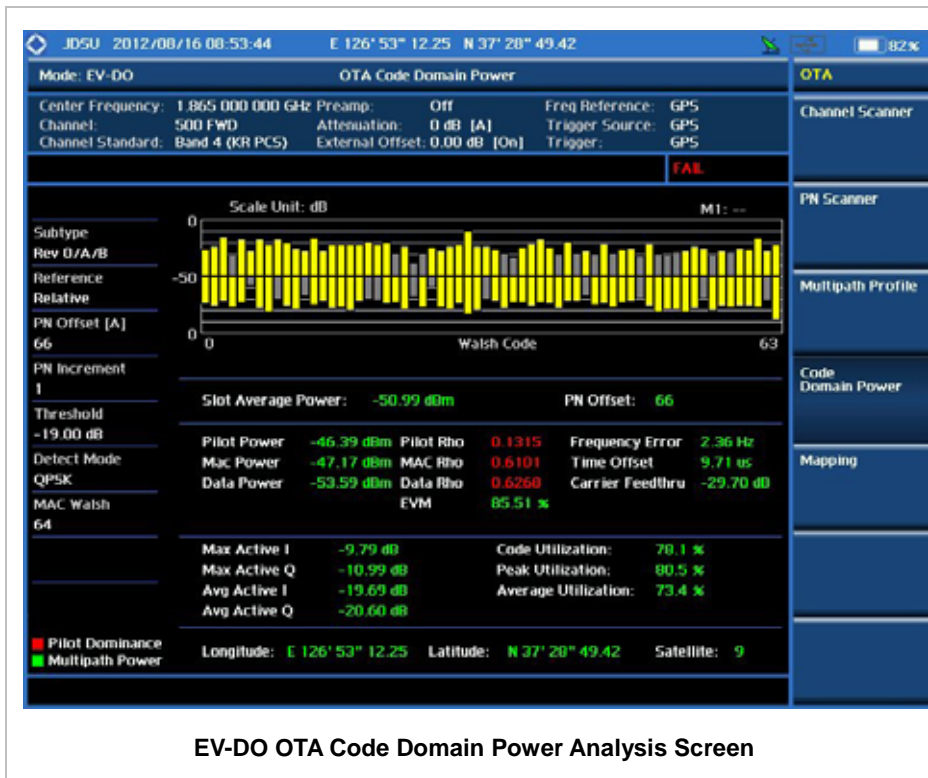

EV-DO ROUTE MAP

The JD740A Series provides indoor and outdoor mapping function that allows a user to collect data of points in an indoor or outdoor environment and track the received signals and coverage of RF transmitters plotting real time directly on top of a loaded floor plan or a map.

Measurement Procedure

| Step | Description |
|---|--|
| 1. Set the measurement mode MEASURE [OTA] [Route Map] | Press the MEASURE hot key. Press the OTA soft key. Press the Route Map soft key. |
| 2. Set the measurement parameters MEASURE SETUP [Load Map] | Press the MEASURE SETUP hot key. After plugging in a USB drive, press the Load Map soft key to load a map file created in JDMAPCreator and copied into the USB drive. |

| | |
|---|--|
| <p>[Plot Point] [Position] or [GPS]</p> | <p>Press the Plot Point soft key to get option menu. Press the Position soft key without a GPS antenna or the GPS with one. Selecting GPS activates the Screen Mode soft key to be set.</p> |
| <p>[Plot Item] [Pilot Power] or [Ec/Io]</p> | <p>Press the Plot Item soft key. Select either Pilot Power or Ec/Io as needed.</p> |
| <p>[Screen Mode] <Map> or <Full></p> | <p>Press the Screen Mode soft key. Toggle this key between Map and Full.</p> |
| <p>[PN Increment] Enter a value [Enter]</p> | <p>Press the PN Increment soft key. Use the numeric keys to input value. Press the Enter soft key.</p> |
| <p>[Plot] <Start> or <Stop></p> | <p>Press the Plot soft key to start or stop plotting. Toggle this key between Start and Stop.</p> |

MEASURE SETUP



Sets the measurement parameters for the Route Map. The legend displayed in different colors at the bottom of the screen can be set with the **Limit** hot key.

- n **PLOT:** Starts or stops a measurement in order to plot received signals or collected data on top of a loaded map. Toggle this key between **Start** and **Stop**. The instrument does not automatically save collected data. After stopping the current route mapping, the user needs to save the result with the **Save** hot key for later use. If not, all the collected data for the route will be lost.
- n **PLOT POINT:** Selects a method of plotting points.
 - Y **POSITION:** Measures data without GPS in an indoor environment. After starting to plot, press the **Enter** hard key or the center of the rotary knob as you move with the instrument. Each time the user presses the key or the knob, the instrument plots a point on top of the loaded map. Use the arrow keys to change direction of route and the rotary knob to change distance. If the instrument has the screen with touch screen, directly touch the screen in order to collect data.
 - Y **GPS:** Automatically collects data with GPS in an outdoor environment and plots points as the user moves in a vehicle.
- n **PLOT ITEM:** Selects either **Pilot Power** or **Ec/Io**. The instrument collects the strongest PN data from its PN Scanner and plots them.
- n **SCREEN MODE:** Selects either **Map** or **Full**, depending on how to show collected points on the screen. Selecting GPS for the Plot Point activates this key. Numbers shown next to the points

represent their PN offsets. The instrument displays PN offset of the start point and those of the points with different PN offsets from the right previous ones.

- Y **MAP:** Displays collected points only that can be seen within the boundary of the loaded map. If a point is off the map, the instrument displays an arrow indicating the direction of the current location on the map and the distance from the center to the location at the top of the screen.
- Y **FULL:** Displays all the measured points for the route on the screen without the map.
- n **LOAD MAP:** Loads a floor plan or a map file created in **JDMapCreator**. The JDMapCreator converts and resizes any scanned floor plan or layout so that it can be loaded and fit to the instrument display.
- n **PN INCREMENT:** Sets the increment step for the PN Offset. Use the numeric keys to enter a value and press the **Enter** soft key or the **ENTER** hard key to complete to the input.

Setting Limit



This hot key is used to set threshold values for the legend displayed on the screen. The different colors of the legend indicate the quality of the measured data depending on their threshold setting. The user input window must be inactive first to get the Limit hot key function other than the number input.

| Step | Description |
|----------------------|---|
| 1. Set the limit | |
| Limit | Press the LIMIT hot key. |
| [Pilot Power] | Press the Pilot Power soft key to set its threshold. |
| [Excellent] | Press the Excellent soft key. |
| Enter a value | Use the rotary knob or the numeric keys. |
| [Enter] | Press the Enter soft key. |
| [Very Good] | Press the Very Good soft key. |
| Enter a value | Use the rotary knob or the numeric keys. |
| [Enter] | Press the Enter soft key. |
| [Good] | Press the Good soft key. |
| Enter a value | Use the rotary knob or the numeric keys. |
| [Enter] | Press the Enter soft key. |
| [Fair] | Press the Fair soft key. |
| Enter a value | Use the rotary knob or the numeric keys. |
| [Enter] | Press the Enter soft key. |
| [Poor] | Press the Poor soft key. |
| Enter a value | Use the rotary knob or the numeric keys. |

| | |
|----------------|---|
| [Enter] | Press the Enter soft key. |
| [Ec/Io] | Press the Ec/Io soft key to set its threshold. |
| [Good] | Press the Good soft key. |
| Enter a value | Use the rotary knob or the numeric keys. |
| [Enter] | Press the Enter soft key. |
| [Fair] | Press the Fair soft key. |
| Enter a value | Use the rotary knob or the numeric keys. |
| [Enter] | Press the Enter soft key. |
| [Poor] | Press the Poor soft key. |
| Enter a value | Use the rotary knob or the numeric keys. |
| [Enter] | Press the Enter soft key. |

Measurement Example



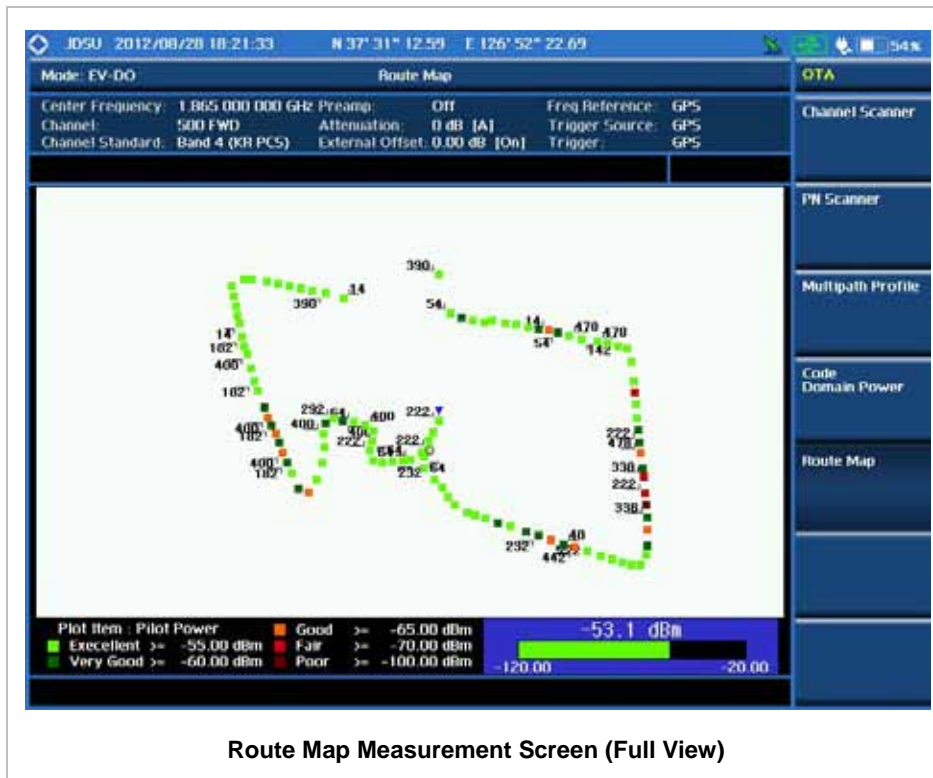

ANALYSIS

Using Marker

MARKER



Marker is used to get the information about a specific trace. Six markers can be set on the display and each marker can be used independently. The X and Y coordinates of the trace are displayed when the marker is placed on any position of the trace. The position displaying the marker's X and Y coordinates may be slightly different for each measurement mode and refer to the description of each measurement. There are three different marker types available: Normal, Delta, and Delta pair. Marker position can be set manually by entering numeric values (frequency) when one of the marker types is selected.

- n **SELECT MARKER:** Selects an active marker whose position can be changed with the rotary knob or the arrow keys. The assigned number of the active marker is displayed in the **Select Marker** menu box and the active marker number is also displayed right next to the active marker on the trace when the **Marker View** is set to **On**.
- n **MARKER VIEW:** Displays the selected marker on the screen or hides it. When the **Marker View**

is turned off and then on again in the same measurement mode, markers appear at the previous positions. If a measurement mode is changed, markers are not restored to their previous positions.

- n **NORMAL:** This Normal marker type provides the reading of a marker position on the trace along with the marker number between 1 and 6.
- n **DELTA:** This Delta marker type is associated with a Normal marker. A Normal marker must be set before a Delta marker is set. When the Delta marker is set, the position set by the Delta marker becomes the reference position of the Normal marker and the marker's X and Y values displays the difference compared with the Delta marker.
- n **DELTA PAIR:** This Delta Pair marker type is associated with a Normal marker. A Normal marker must be set before a Delta Pair marker is set. When the Delta Pair marker is set, the position set by the Delta Pair marker becomes the reference position of the Normal marker and the marker's X and Y values displays the difference compared with the Delta Pair marker. The reference position will be varied in accordance with trace change.
- n **MARKER ALL OFF:** Turns all the markers the screen off. When the Marker View is selected for those markers, the instrument displays those markers back at the previous position. If a measurement mode is changed, current settings are not restored.
- n **MARKER Δ :** Sets the X coordinate of the active marker as selected.
 - Y **MARKER Δ CENTER:** Sets the frequency of the active marker to the center frequency of spectrum analyzer.
 - Y **MARKER Δ START:** Sets the frequency of the active marker to the start frequency of spectrum analyzer.
 - Y **MARKER Δ STOP:** Sets the frequency of the active marker to the stop frequency of spectrum analyzer.

Using Peak Search

PEAK SEARCH



Each time the Peak Search soft key is pressed, the active marker is positioned at the highest peak of the trace.

- n **PEAK SEARCH:** Moves the active marker to the highest peak of the trace.
- n **NEXT PEAK:** Moves the active marker to the second highest peak of the trace.
- n **NEXT PEAK RIGHT:** Moves the active marker to the highest peak to the right of its current position.
- n **NEXT PEAK LEFT:** Moves the active marker to the highest peak to the left of its current position.

- n **MIN SEARCH:** Moves the active marker to the lowest peak of the trace.
- n **ALWAYS PEAK:** When the **Always Peak** is set to On, the instrument moves the active marker automatically to the highest peak of the trace every time the trace is refreshed.

GSM/GPRS/EDGE Signal Analyzer

This GSM/GPRS/EDGE Signal Analyzer function is optional that the JD740A series offers as the Option 022 for GSM/GPRS/EDGE. It allows the user to check conformity to the 3GPP TS 51.021 Base Station System (BSS) equipment specification: Radio Aspects V8.9.0 (2003-06) and analyze GSM/EDGE system performance. The GSM//GPRS/EDGE OTA Analyzer which is the Option 042 can be added to the GSM/GPRS/EDGE Signal Analyzer for Over The Air measurement.

In this Chapter

| | |
|---|----|
| Using GSM/GPRS/EDGE Signal Analyzer | 4 |
| Display Overview | 5 |
| Connecting a Cable | 6 |
| Direct Connection..... | 6 |
| Indirect Connection | 7 |
| Over The Air (OTA) | 7 |
| Spectrum Analysis Measurement..... | 9 |
| Setting Mode | 9 |
| Setting Frequency | 9 |
| Setting Amplitude | 10 |
| Setting Averaging | 12 |
| Setting Sweep Mode | 12 |
| Setting Trigger Level | 12 |
| Setting Trace and Display | 13 |
| Measurement Procedure | 13 |
| Measurement Example | 14 |
| RF Analysis Measurements..... | 14 |
| Setting Mode | 15 |
| Setting Frequency | 15 |
| Setting Amplitude | 16 |
| Setting Averaging | 18 |
| Setting Sweep Mode | 18 |
| Setting Trigger Level | 18 |
| Channel Power | 19 |
| Measurement Procedure | 19 |
| Setting Limit | 20 |
| Measurement Example | 20 |
| Occupied Bandwidth..... | 21 |
| Measurement Procedure | 21 |
| Setting Limit | 22 |
| Measurement Example | 22 |
| Spectrum Emission Mask (SEM)..... | 23 |

| | |
|---|----|
| Measurement Procedure | 23 |
| Setting Limit | 24 |
| Measurement Example | 24 |
| Spurious Emissions | 25 |
| Measurement Procedure | 25 |
| Setting Limit | 27 |
| Measurement Example | 28 |
| Power vs Time Analysis Measurements | 28 |
| Setting Mode | 29 |
| Setting Frequency | 29 |
| Setting Amplitude | 30 |
| Setting Averaging | 31 |
| Setting Sweep Mode | 32 |
| Setting Trigger Level | 32 |
| Power vs Time (Slot) | 33 |
| Measurement Procedure | 33 |
| Setting Limit | 33 |
| Measurement Example | 34 |
| Power vs Time (Frame) | 35 |
| Measurement Procedure | 35 |
| Setting Limit | 36 |
| Measurement Example | 36 |
| Modulation Analysis Measurement..... | 37 |
| Setting Mode | 37 |
| Setting Frequency | 38 |
| Setting Amplitude | 39 |
| Setting Averaging | 40 |
| Setting Display | 40 |
| Setting Sweep Mode | 40 |
| Setting Trigger Level | 41 |
| Constellation | 41 |
| Measurement Procedure | 41 |
| Setting Limit | 42 |
| Measurement Example | 45 |
| Auto Measurement | 45 |
| Setting Mode | 46 |
| Setting Frequency | 46 |
| Setting Limit | 47 |
| Measurement Procedure | 50 |
| Setting Display | 52 |
| GSM OTA Measurements..... | 52 |
| Setting Mode | 53 |
| Setting Frequency | 53 |
| Setting Amplitude | 54 |
| Setting Averaging | 56 |
| Setting Sweep Mode | 56 |
| Setting Trigger Level | 56 |
| GSM OTA Channel Scanner..... | 57 |
| Measurement Procedure | 57 |
| Setting Display | 58 |
| Measurement Example | 59 |
| GSM OTA Frequency Scanner | 59 |
| Measurement Procedure | 59 |

| | |
|-----------------------------------|----|
| Setting Display | 60 |
| Measurement Example | 61 |
| GSM OTA Multipath Profile..... | 61 |
| Measurement Procedure | 62 |
| Measurement Example | 62 |
| GSM OTA Modulation Analyzer | 63 |
| Measurement Procedure | 63 |
| Setting Limit | 63 |
| Measurement Example | 65 |
| Analysis | 65 |
| Using Marker..... | 65 |
| Using Peak Search | 66 |

(Rev. 6.0)

USING GSM/GPRS/EDGE SIGNAL ANALYZER

The Global System for Mobile Communications (GSM) is a digital cellular standard that uses Time Division Multiple Access (TDMA) multiplexing scheme and Gaussian Minimum Shift Keying (GMSK) modulation. The Enhanced Data Rates for GSM Evolution (EDGE) is an enhancement to GSM that promises to deliver multimedia and other broadband applications. It uses TDMA and $3\pi/8$ 8PSK (phase shift keying) modulation.

This instrument performs measurements using the methods and limits as defined in the 3GPP TS 51.021 Base Station System (BSS) equipment specification: Radio Aspects V8.9.0 (2003-06). The Pass/Fail indicator helps the user to determine base station performance easily.

This instrument provides the following analysis tools for GSM/GPRS/EDGE system.

- n Spectrum Analysis
- n RF Analysis
 - Y Channel Power
 - Y Occupied Bandwidth
 - Y Spectrum Emission Mask
 - Y Spurious Emissions
- n Power vs Time
 - Y Slot
 - Y Frame
- n Modulation Analysis
 - Y Constellation
- n Auto Measure
- n Over The Air (OTA)
 - Y Channel Scanner
 - Y Frequency Scanner
 - Y Multipath Profile
 - Y Modulation Analyzer

DISPLAY OVERVIEW

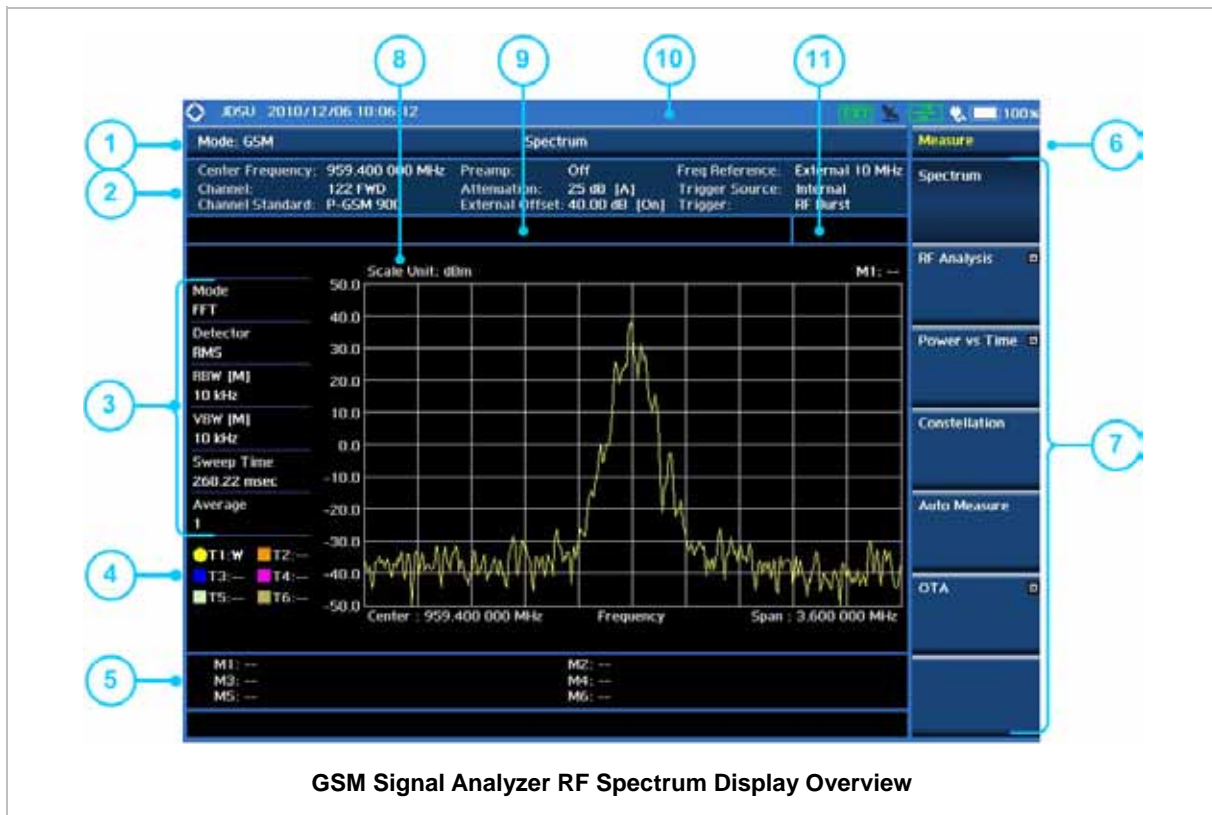

Measurement Mode Information: GSM Signal Analyzer

Spectrum Input Level Setting Information: This window shows the most common settings or parameters of each measurement.

- Frequency and Channel Setting
- Amplitude Setting (Preamp, Attenuation, External Offset)
- Reference Setting (Frequency, Trigger)

Measurement Setting Information

- Spectrum Analyzer Operation Mode Information
- Detector Type Setting Information
- Spectrum Setting Information (RBW, VBW)
[A]: Auto mode, [M]: Manual mode
- Sweep Time Information: Displays current sweep time
- Average Number Information set through BW/AVG hard key. It shows the number of traces to be averaged.

Trace Information

- C: Captured
- M: Max Hold
- m: Min Hold

- W: Write Current Trace (Indicates current active trace)
- L: Loaded
- F: Trace View Off

Information on Marker Table displays up to 6 markers

Screen Menu Title

Screen Menu and Sub-menu

Scale Unit Information: dBm, dBV, dBmV, dBuV, V, and W

User Input Window: Activates when user input menu or key is selected. Pressing ESC hard key will cancel or deactivate user input window. Inactivate user input window before using hot keys.

NOTE: It is very important to inactivate the user input window when you intend to use the hot key menu on the numeric keys.

System Information

- Date and Time
- Positioning Information (Longitude and Latitude). It is available only when a GPS antenna is connected. Frequency reference is automatically set to GPS in the System menu when a GPS antenna is connected.
- Frequency Reference Indicator: INT for internal and EXT for external. The EXT icon is green when an external reference is locked or red when the external reference is not locked. When a GPS antenna is connected, this space will be blank.
- GPS Indicator: Color of the GPS icon changes among green, yellow and gray depending on locking status.
- USB Indicator
- DC Input Power Indicator
- Battery Indicator

Pass/Fail Indicator

CONNECTING A CABLE

Direct Connection

Connect the **Spectrum Analyzer RF In 50 Ω** port of the JD740A series and the PA output port of BTS.

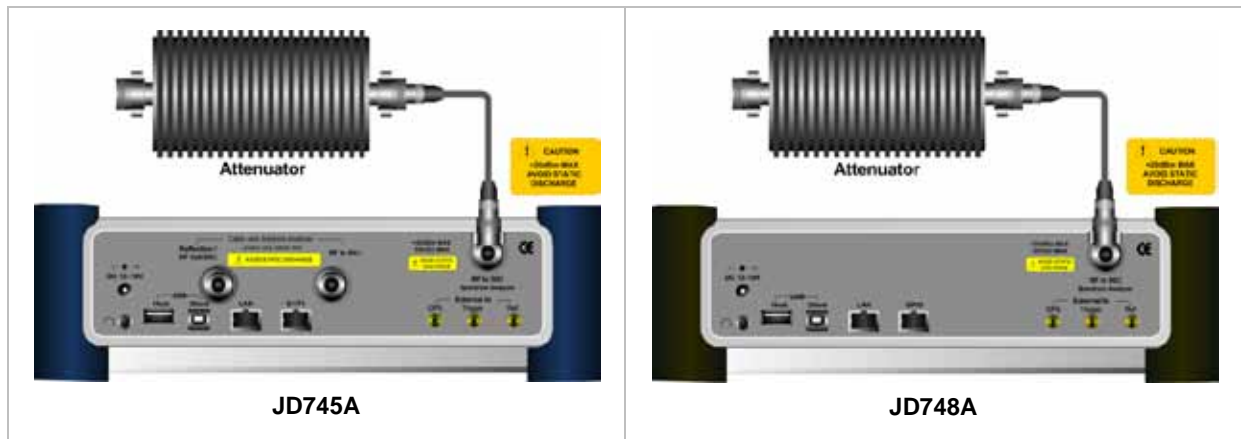

Indirect Connection

Connect the **Spectrum Analyzer RF In 50 Ω** port of the JD740A series and the monitor port of BTS.

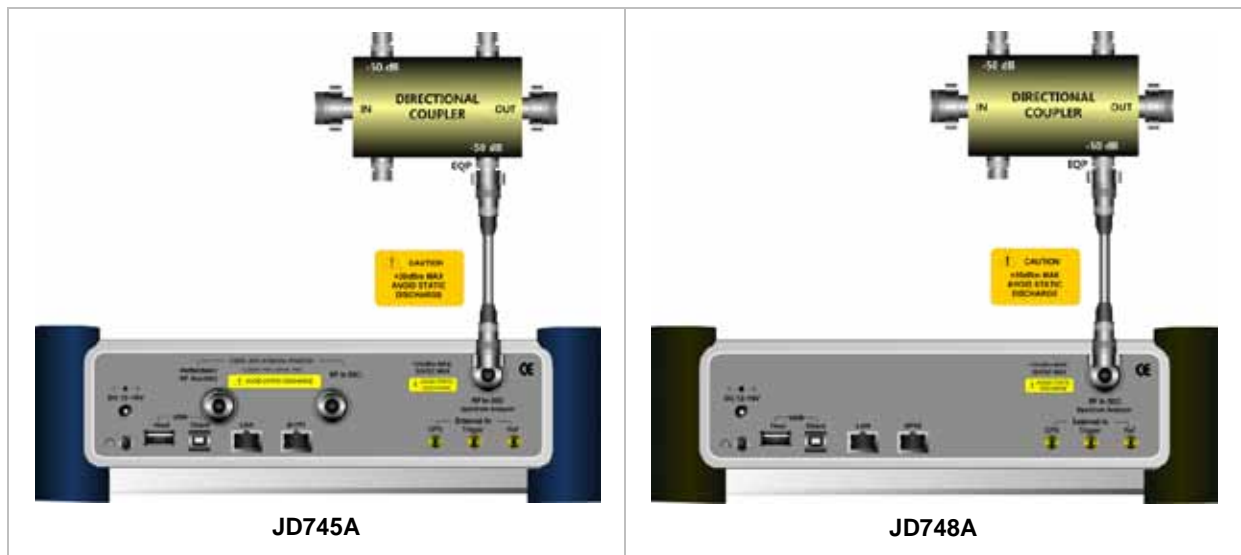

The maximum power for the **Spectrum Analyzer RF In 50 Ω** port is +20 dBm (0.1 Watt). If the input signal level to be measured is greater than +20 dBm, use a **High Power Attenuator** to prevent damage when you directly connect the signal to the instrument. Or connect a signal from the coupling port of a directional coupler.

Over The Air (OTA)

Connect an Omni/directional RF antenna to the **Spectrum Analyzer RF In 50 Ω** port of the JD740A series and then a GPS antenna to the **GPS** port of the JD740A series.

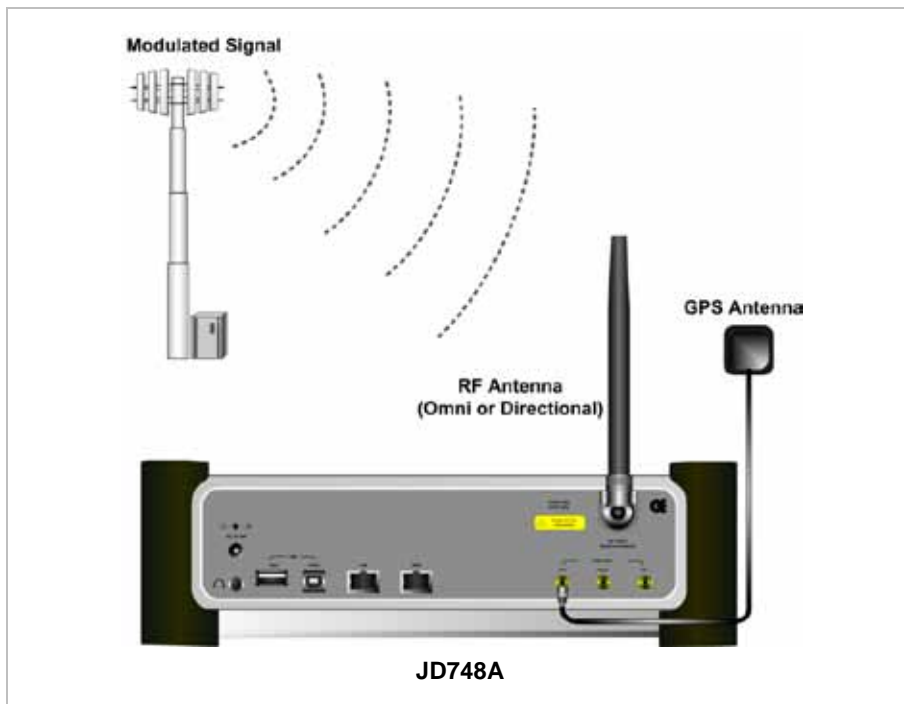
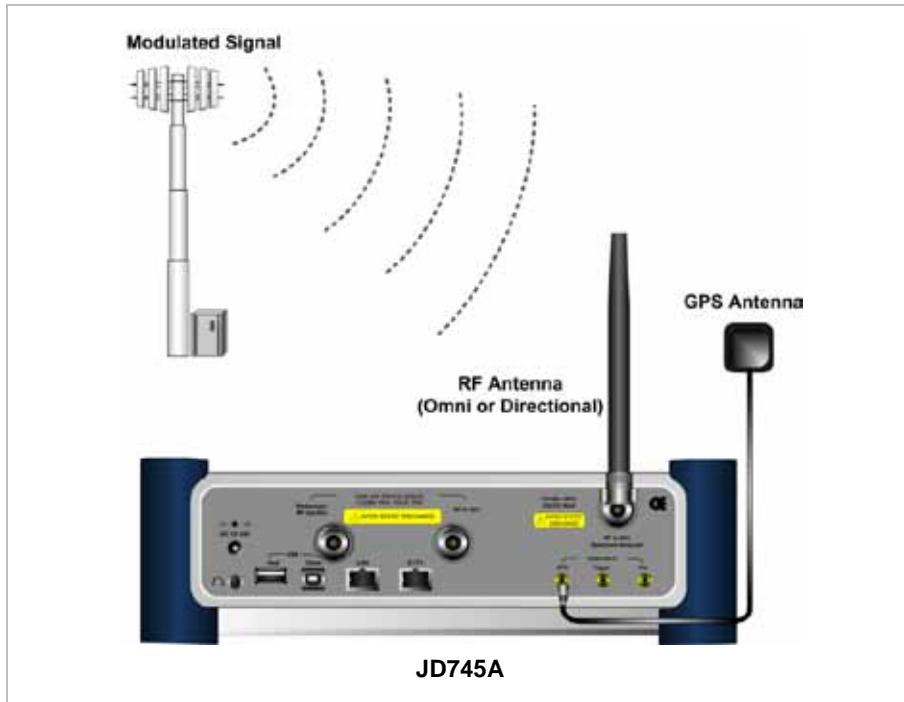

 If the input signal level to be measured is less than 0 dBm, set 0 dB attenuation or turn on the preamp to have better dynamic range for the OTA testing.

SPECTRUM ANALYSIS MEASUREMENT

Setting Mode

| Step | Description |
|--|---|
| 1. Connect the cable | Connect a cable directly or indirectly as shown in the section Connecting a Cable on page 6 of this chapter. |
| 2. Select the mode MODE [Signal Analyzer] [GSM] [Spectrum] | Press the MODE hard key. Press the Signal Analyzer soft key. Press the GSM soft key. Press the Spectrum soft key. (Spectrum mode is set by default.) |

Setting Frequency

| Step | Description |
|--|--|
| 1. Set the frequency FREQ/DIST [Unit] <Freq> or <Channel> | Press the FREQ/DIST hard key. Press the Unit soft key. Toggle this key between Freq and Channel . A set of Freq/Dist screen menu changes accordingly. |
| <u>When Freq is selected:</u> [Center Frequency] Enter a value [GHz], [MHz], [kHz], or [Hz] | Press the Center Frequency soft key. Use the numeric keys, the rotary knob, or the arrow keys. When using the numeric keys, the input is completed by selecting one of the unit soft keys. |
| <u>When Channel is selected:</u> [Channel Standard] Select a channel standard | Press the Channel Standard soft key. Press the arrow keys, rotate the knob, or press the Page Up and Page Down soft keys to highlight a frequency band to select. |
| [Select] or ENTER | Press the Select soft key or the ENTER hard key. |
| [Channel Number] Enter a value [Forward] | Press the Channel Number soft key. Use the numeric keys to input value and press the Forward soft key to complete the input. The instrument automatically displays its corresponding center frequency value for the |

| | |
|--|-----------------|
| | channel number. |
|--|-----------------|

FREQ/DIST 

- n **UNIT:** Determines the way how to set the frequency band either with standard band or custom frequency band. Toggling this key between **Freq** and **Channel** changes a set of Freq/Dist screen menu automatically.
- n **CENTER FREQUENCY:** Changes the center frequency setting. Use the rotary knob or the arrow keys. Or use the numeric keys to input a certain value and press one of the unit soft keys to complete the input.
- n **FREQUENCY STEP:** Defines the amount of frequency to be increased or decreased when using the rotary knob or the arrow keys to change the **Center Frequency**. This frequency step size can be entered by using numeric keys and the unit soft keys.
- n **CHANNEL NUMBER:** Enters a channel number. The instrument automatically displays its corresponding center frequency value for the channel number.
- n **CHANNEL STEP:** Defines the amount of channel to be increased or decreased when using the rotary knob or the arrow keys to change the **Channel Number**. This channel step size can be entered by using numeric keys and the **Enter** soft key.
- n **CHANNEL STANDARD:** When the channel standard is selected from the list, the center frequency information on the display screen will be mapped accordingly to the selected channel standard. The channel standards available in the instrument are listed in the Appendix C – Band, Frequency & Channel Standard.

Setting Amplitude

| Step | Description |
|--|---|
| 1. Set the reference/attenuation level AMP/SCALE [Auto Scale] or [Reference Level] Enter a reference level value | Press the AMP/SCALE hard key. Press the Auto Scale soft key to automatically set optimum levels of reference and attenuation. Press the Reference Level soft key to set manually. Use the numeric keys or the rotary knob that changes in a 10 dB step. |

| | |
|----------------------------|---|
| [dBm] or ENTER | Press the dBm soft key or the ENTER hard key. |
| [Attenuation] | Press the Attenuation soft key. The Auto mode is set by default. This key toggles between the Auto and Manual . |
| <Manual> | Press the Attenuation soft key to highlight the Manual mode and change the attenuation value to optimize S/N. |
| Enter an attenuation value | Use the numeric keys or the rotary knob that changes in a 5 dB step. The attenuation setting range is 0 to 50 dB. |

AMP/SCALE



- n **AUTO SCALE:** The instrument can automatically set the scale to the minimum and maximum values on the Y-axis of the graph for optimum display of the traces measured. Each time the **Auto Scale** is selected, the top and bottom scales are set to the minimum and maximum values with margin on the Y-axis of the display screen.
- n **REFERENCE LEVEL:** Sets the maximum Y-axis range.
- n **SCALE/DIV:** Is used only for the Spectrum measurement screen. It represents the value of one division on the horizontal scale. The default value is 10 dB per division and the Y-Scale is set to 100 dB. Selecting the **Scale/Div** soft key enables to set the value to 1 dB per division with the numeric keys or the rotary knob.
- n **ATTENUATION**
 - Y **AUTO:** Input attenuator's value is automatically set depending on the reference level. This is the default operation mode, so it is recommended to use this mode unless a special measurement condition is needed.
 - Y **MANUAL:** Sets the attenuator's value for the **Spectrum Analyzer RF In 50 Ω** port.
- n **PREAMP:** Turns on or off the internal pre-amplifier. Preamp results in a correction being applied to compensate for the gain of the preamp so that amplitude readings show the value at the input connector. This soft key toggles between the **On** and **Off**. When it is set to On, the allowable attenuation input range is from 0 dB to 10 dB in a multiple of 5. If the attenuation value is manually set greater than 10 dB, the instrument will automatically turn off the pre-amplifier to display low level signal properly on the screen.
- n **UNITS:** Sets the scale unit on the display among **dBm**, **dBV**, **dBmV**, **dBuV**, **V**, and **W**.
- n **EXTERNAL OFFSET:** Sets an external offset value. An offset consists of a cable loss and a user offset and the measurement result shows the value reflecting both offset values. When the external offset value is set at 40 dB in the Spectrum mode, the measurement result compensates 40 dB at both the Spectrum Analyzer and Signal Analyzer modes.

Setting Averaging

BW/AVG



- n **AVERAGE:** Sets the number of measurements to be averaged for the trace presentation. A maximum of 100 times of averaging can be set.

| Step | Description |
|---|---|
| 1. Set the averaging BW/AVG [Average] | Press the BW/AVG hard key. Press the Average soft key. |
| 2. Enter number of averaging to set | Use the numeric keys and input a number between 1 and 100. When the averaging reaches to the number set here, a new measurement value replaces the earliest measurement value in sequence. |
| 3. [Enter] or ENTER | Press the Enter soft key or the ENTER hard key. |

Setting Sweep Mode

SWEEP



This hot key is used to set the sweep parameters. The user input window must be inactive first to get the Sweep hot key function other than the number input.

- n **SWEEP MODE:** Sets the sweep method. Toggle between **Continue** and **Single**.

| Step | Description |
|--|---|
| 1. Set the sweep mode SWEEP [Sweep Mode] | Press the SWEEP hot key. Press the Sweep Mode soft key. Toggle between Continue and Single . |

Setting Trigger Level

TRIGGER



This hot key is used to select the trigger level among **RF Burst**, **Internal FB**, **RF Burst & TS**, **External**, and **Free**. The user input window must be inactive first to get the Trigger hot key function other than the number input.

- n **RF BURST:** Sets the trigger level when using the RF Burst (wideband) trigger. The value is relative to the peak of the signal. RF Burst is also known as RF Envelope.
- n **INTERNAL FB:** Sets the trigger level to Free Burst if there is a frequency burst signal.
- n **RF BURST & TS:** Sets the trigger level to Training Sequence Code.
- n **EXTERNAL:** Sets the trigger level to external trigger reference.
- n **FREE:** Sets the free trigger (auto trigger).

Setting Trace and Display

TRACE/DISPLAY



- n **SELECT TRACE:** Selects an active trace from T1 to T6. Trace numbers are assigned to each captured trace or loaded trace. Pressing one of the 6 trace number soft keys sets the selected trace number as the active trace on the display screen.
- n **CLEAR WRITE:** Clears the selected trace and writes or assigns the current trace.
- n **MAX HOLD:** Sets the active trace to display the maximum response of the input signal. Active trace compares newly acquired data with the trace shown on the screen and displays the bigger trace on the display screen.
- n **MIN HOLD:** Sets the active trace to display the minimum response of the input signal. Active trace compares newly acquired data with the trace shown on the screen and displays the smaller trace on the display screen.
- n **CAPTURE:** Captures a current trace on the display screen with the selected trace number.
- n **TRACE VIEW:** Displays the trace of the selected trace number on the display screen or hides it from the display screen. Press the **Select Trace** soft key to select a trace number and then press the **Trace View** soft key to toggle between the **Off** to hide and **On** to restore a hidden trace.
- n **TRACE CLEAR ALL:** Deletes all traces from the instrument and initializes the trace settings.

Measurement Procedure

| Step | Description |
|---|--|
| 1. Select the measurement mode MEASURE [Spectrum] | Press the MEASURE hot key. Press the Spectrum soft key. |

GSM Spectrum Measurement Procedure



MEASURE SETUP

n MISCELLANEOUS

- ÿ **DELAY:** Sets the delay in micro seconds. This key is used only when there is a time offset in the signals to be measured.

Measurement Example

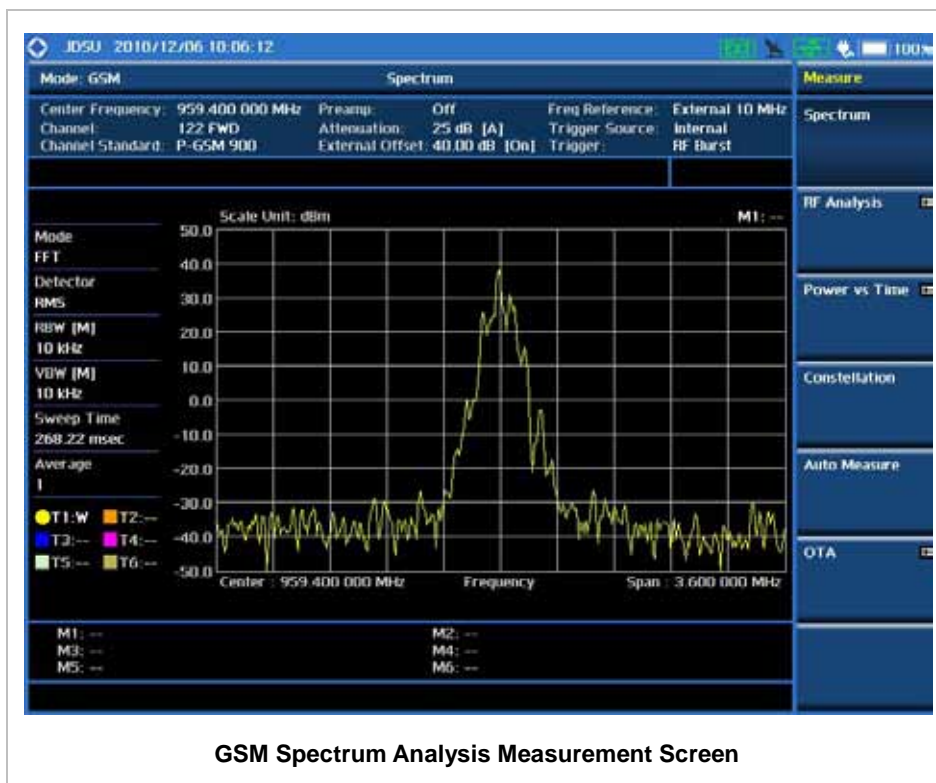

RF ANALYSIS MEASUREMENTS

RF Analysis in GSM/GPRS/EDGE Signal Analyzer provides single-button measurements for the following measurements.

- n Channel Power
- n Occupied Bandwidth
- n Spectrum Emission Mask
- n Spurious Emissions

Setting Mode

| Step | Description |
|---|---|
| 1. Connect the cable | Connect a cable directly or indirectly as shown in the Connecting a Cable on page 6 of this chapter. |
| 2. Select the mode MODE [Signal Analyzer] [GSM] [RF Analysis] [Channel Power], [Occupied BW], [Spectrum Emission Mask], or [Spurious Emissions] | Press the MODE hard key. Press the Signal Analyzer soft key. Press the GSM soft key. Press the RF Analysis soft key. Press one of the measurement mode soft keys to select. |

Setting Frequency

This setting is not used in the Spurious Emissions mode.

| Step | Description |
|--|--|
| 1. Set the frequency FREQ/DIST [Unit] <Freq> or <Channel> <u>When Freq is selected:</u> [Center Frequency] Enter a value [GHz], [MHz], [kHz], or [Hz] <u>When Channel is selected:</u> [Channel Standard] Select a channel standard [Select] or ENTER | Press the FREQ/DIST hard key. Press the Unit soft key. Toggle this key between Freq and Channel . A set of Freq/Dist screen menu changes accordingly. Press the Center Frequency soft key. Use the numeric keys, the rotary knob, or the arrow keys. When using the numeric keys, the input is completed by selecting one of the unit soft keys. Press the Channel Standard soft key. Press the arrow keys, rotate the knob, or press the Page Up and Page Down soft keys to highlight a frequency band to select. Press the Select soft key or the ENTER hard key. |

| | |
|---|--|
| <p>[Channel Number] Enter a value [Forward]</p> | <p>Press the Channel Number soft key. Use the numeric keys to input value and press the Forward soft key to complete the input. The instrument automatically displays its corresponding center frequency value for the channel number.</p> |
|---|--|

FREQ/DIST



- n **UNIT:** Determines the way how to set the frequency band either with standard band or custom frequency band. Toggling this key between **Freq** and **Channel** changes a set of Freq/Dist screen menu automatically.
- n **CENTER FREQUENCY:** Changes the center frequency setting. Use the rotary knob or the arrow keys. Or use the numeric keys to input a certain value and press one of the unit soft keys to complete the input.
- n **FREQUENCY STEP:** Defines the amount of frequency to be increased or decreased when using the rotary knob or the arrow keys to change the **Center Frequency**. This frequency step size can be entered by using numeric keys and the unit soft keys.
- n **CHANNEL NUMBER:** Enters a channel number. The instrument automatically displays its corresponding center frequency value for the channel number.
- n **CHANNEL STEP:** Defines the amount of channel to be increased or decreased when using the rotary knob or the arrow keys to change the **Channel Number**. This channel step size can be entered by using numeric keys and the **Enter** soft key.
- n **CHANNEL STANDARD:** When the channel standard is selected from the list, the center frequency information on the display screen will be mapped accordingly to the selected channel standard. The channel standards available in the instrument are listed in the Appendix C – Band, Frequency & Channel Standard.

Setting Amplitude

| Step | Description |
|--|--|
| <p>1. Set the reference/attenuation level AMP/SCALE [Auto Scale]</p> <p>or</p> <p>[Reference Level]</p> | <p>Press the AMP/SCALE hard key. Press the Auto Scale soft key to automatically set optimum levels of reference and attenuation.</p> <p>Press the Reference Level soft key to set manually.</p> |

| | |
|-------------------------------|---|
| Enter a reference level value | Use the numeric keys or the rotary knob that changes in a 10 dB step. |
| [dBm] or ENTER | Press the dBm soft key or the ENTER hard key. |
| [Attenuation] | Press the Attenuation soft key. The Auto mode is set by default. This key toggles between the Auto and Manual . |
| <Manual> | Press the Attenuation soft key to highlight the Manual mode and change the attenuation value to optimize S/N. |
| Enter an attenuation value | Use the numeric keys or the rotary knob that changes in a 5 dB step. The attenuation setting range is 0 to 50 dB. |

AMP/SCALE



- n **AUTO SCALE:** The instrument can automatically set the scale to the minimum and maximum values on the Y-axis of the graph for optimum display of the traces measured. Each time the **Auto Scale** is selected, the top and bottom scales are set to the minimum and maximum values with margin on the Y-axis of the display screen.
- n **REFERENCE LEVEL:** Sets the maximum Y-axis range.
- n **SCALE/DIV:** Is used only for the Spectrum measurement screen. It represents the value of one division on the horizontal scale. The default value is 10 dB per division and the Y-Scale is set to 100 dB. Selecting the **Scale/Div** soft key enables to set the value to 1 dB per division with the numeric keys or the rotary knob.
- n **ATTENUATION**
 - Y **AUTO:** Input attenuator's value is automatically set depending on the reference level. This is the default operation mode, so it is recommended to use this mode unless a special measurement condition is needed.
 - Y **MANUAL:** Sets the attenuator's value for the **Spectrum Analyzer RF In 50 Ω** port.
- n **PREAMP:** Turns on or off the internal pre-amplifier. Preamp results in a correction being applied to compensate for the gain of the preamp so that amplitude readings show the value at the input connector. This soft key toggles between the **On** and **Off**. When it is set to On, the allowable attenuation input range is from 0 dB to 10 dB in a multiple of 5. If the attenuation value is manually set greater than 10 dB, the instrument will automatically turn off the pre-amplifier to display low level signal properly on the screen.
- n **UNITS:** Sets the scale unit on the display among **dBm**, **dBV**, **dBmV**, **dBuV**, **V**, and **W**.
- n **EXTERNAL OFFSET:** Sets an external offset value. An offset consists of a cable loss and a user offset and the measurement result shows the value reflecting both offset values. When the external offset value is set at 40 dB in the Spectrum mode, the measurement result compensates 40 dB at both the Spectrum Analyzer and Signal Analyzer modes.

Setting Averaging



- n **AVERAGE:** Sets the number of measurements to be averaged for the trace presentation. A maximum of 100 times of averaging can be set. *This setting is not used in the Spurious Emissions mode.*

| Step | Description |
|---|--|
| 1. Set the averaging BW/AVG [Average] | Press the BW/AVG hard key. Press the Average soft key. |
| 2. Enter number of averaging to set | Use the numeric keys and input a number between 1 and 100. When the averaging reaches to the number set here, a new measurement value replaces the earliest measurement value in sequence. |
| 3. [Enter] or ENTER | Press the Enter soft key or the ENTER hard key. |

Setting Sweep Mode



This hot key is used to set the sweep parameters. The user input window must be inactive first to get the Sweep hot key function other than the number input.

- n **SWEEP MODE:** Sets the sweep method. Toggle between **Continue** and **Single**.

| Step | Description |
|--|---|
| 1. Set the sweep mode SWEEP [Sweep Mode] | Press the SWEEP hot key. Press the Sweep Mode soft key. Toggle between Continue and Single . |

Setting Trigger Level



This hot key is used to select the trigger level among **RF Burst**, **Internal FB**, **RF Burst & TS**, **External**, and **Free**. The user input window must be inactive first to get the Trigger hot key function other than the number input.

- n **RF BURST**: Sets the trigger level when using the RF Burst (wideband) trigger. The value is relative to the peak of the signal. RF Burst is also known as RF Envelope.
- n **INTERNAL FB**: Sets the trigger level to Free Burst if there is a frequency burst signal.
- n **RF BURST & TS**: Sets the trigger level to Training Sequence Code.
- n **EXTERNAL**: Sets the trigger level to external trigger reference.
- n **FREE**: Sets the free trigger (auto trigger).

CHANNEL POWER

The Channel Power measures in-channel power for GSM/GPRS and EDGE systems, which use dynamic power control to ensure that each link is maintained with minimum power. It gives two fundamental benefits of keeping overall system interference to a minimum level and of maximizing battery life in the case of mobile stations. It determines the power delivered to the antenna system on the RF channel under test. The instrument acquires a GSM/GPRS or EDGE signal in the time domain. The average power level above the threshold is then computed and displayed.

Measurement Procedure

| Step | Description |
|---|---|
| 1. Set the measurement mode MEASURE [RF Analysis] [Channel Power] | Press the MEASURE hot key. Press the RF Analysis soft key. Press the Channel Power soft key. |

GSM Channel Power Measurement Procedure

MEASURE SETUP



- n **MISCELLANEOUS**
 - Y **DELAY**: Sets the delay in micro seconds. This key is used only when there is a time offset in the signals to be measured.

Setting Limit



This hot key is used to set the threshold value for the limit line on the display screen. It turns on or off the limit or band limit settings of the measurement for pass/fail indication. The user input window must be inactive first to get the Limit hot key function other than the number input.

| Step | Description |
|---|---|
| 1. Select the limit LIMIT [RF Test Limits] [Channel Power] [Test Limits] <On> or <Off> [High Limit] Enter a value [dBm] or ENTER [Low Limit] Enter a value [dBm] or ENTER | Press the LIMIT hot key. Press the RF Test Limits soft key. Press the Channel Power soft key. Press the Test Limits soft key to toggle between On and Off and select one. Press the High Limit soft key to set the upper limit of the Pass/Fail criteria. Use the numeric keys to input value. Press the unit soft key or the ENTER hard key. Press the Low Limit soft key to set the lower limit of the Pass/Fail criteria. Use the numeric keys to input value. Press the unit soft key or the ENTER hard key. |
| 2. Enable beep LIMIT [Beep] <On> or <Off> | Press the LIMIT hot key. Press the Beep soft key to toggle between On and Off and select one. This will make audible alarm if the measurement beyond the limit. |

- n **TEST LIMITS:** Enables or disables Pass/Fail results on the display screen. Toggle the **Test Limits** soft key to set it to **On** or **Off**.
- n **HIGH LIMIT:** Sets the upper limit of the Pass/Fail criteria. Use the numeric keys to enter a threshold or limit value and press the **dBm** unit soft key or the **ENTER** hard key to complete the input.
- n **LOW LIMIT:** Sets the lower limit of the Pass/Fail criteria. Use the numeric keys to enter a threshold or limit value and press the **dBm** unit soft key or the **ENTER** hard key to complete the input.

Measurement Example

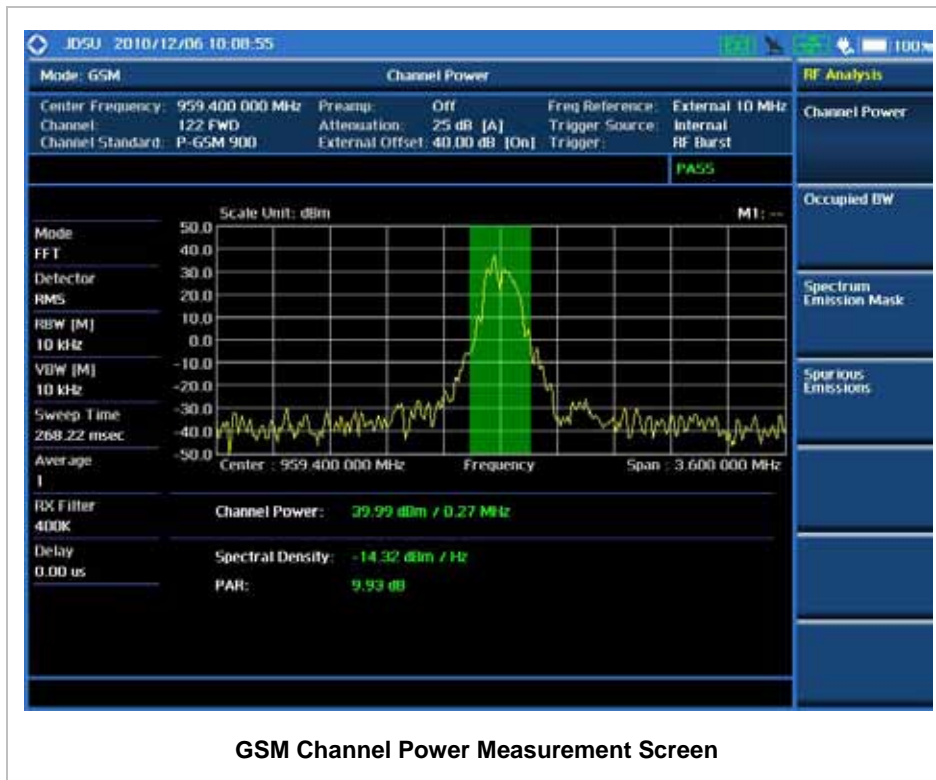

OCCUPIED BANDWIDTH

The Occupied Bandwidth measures the spectrum shape of the carrier. It is defined as the bandwidth which includes 99% of the transmitted power among total transmitted power.

Measurement Procedure

| Step | Description |
|---|---|
| 1. Set the measurement mode MEASURE [RF Analysis] [Occupied BW] | Press the MEASURE hot key. Press the RF Analysis soft key. Press the Occupied BW soft key. |

GSM Occupied BW Measurement Procedure

MEASURE SETUP



n MISCELLANEOUS

Y **DELAY:** Sets the delay in micro seconds. This key is used only when there is a time offset in

the signals to be measured.

Setting Limit



This hot key is used to set the threshold value for the limit line on the display screen. It turns on or off the limit or band limit settings of the measurement for pass/fail indication. The user input window must be inactive first to get the Limit hot key function other than the number input.

| Step | Description |
|---|--|
| 1. Select the limit LIMIT [RF Test Limits] [Occupied BW] [Test Limit] <On> or <Off> [High Limit] Enter a value [MHz], [kHz], or [Hz] | Press the LIMIT hot key. Press the RF Test Limits soft key. Press the Occupied BW soft key. Press the Test Limit soft key to toggle between On and Off and select one. Press the High Limit soft key to set the upper limit of the Pass/Fail criteria. Use the numeric keys to input value. Press the unit soft key to select. |
| 2. Enable beep LIMIT [Beep] <On> or <Off> | Press the LIMIT hot key. Press the Beep soft key to toggle between On and Off and select one. This will make audible alarm if the measurement beyond the limit. |

- n **TEST LIMIT:** Enables or disables Pass/Fail results on the display screen. Toggle the **Test Limit** soft key to set it to **On** or **Off**.
- n **HIGH LIMIT:** Sets the upper limit of the Pass/Fail criteria. Use the numeric keys to enter a threshold or limit value and press one of the unit soft keys to complete the input.

Measurement Example

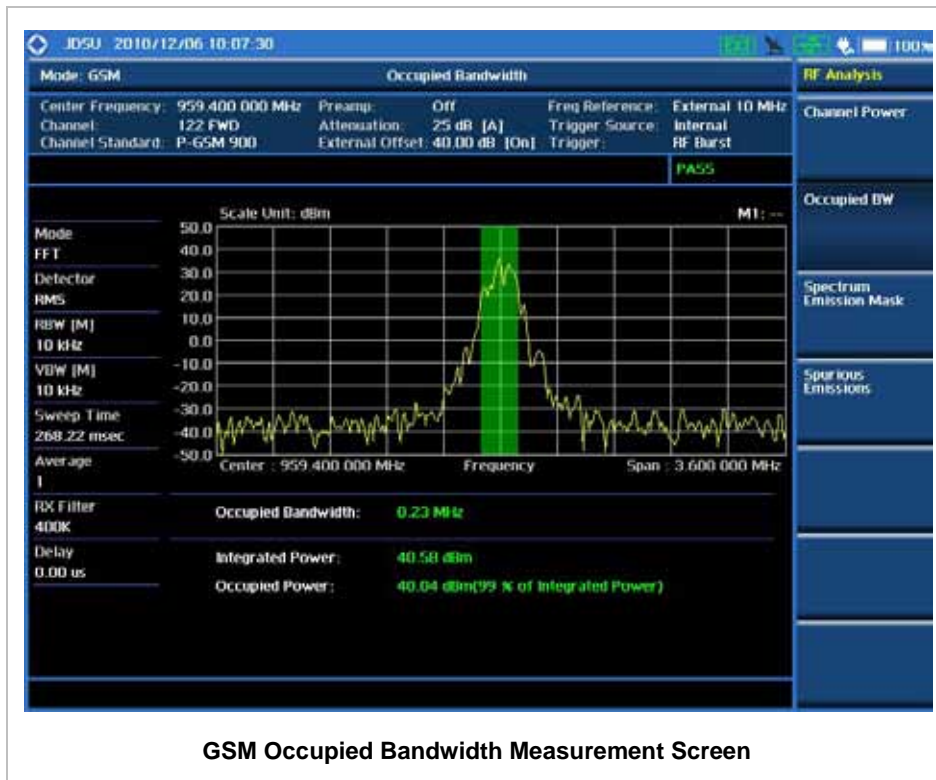

GSM Occupied Bandwidth Measurement Screen

SPECTRUM EMISSION MASK (SEM)

The Spectrum Emission Mask (SEM) measurement verifies whether or not the transmitter transmits undesirable energy into the transmission band. This energy may cause interference with other users of the GSM system.

Measurement Procedure

| Step | Description |
|--|--|
| 1. Set the measurement mode MEASURE [RF Analysis] [Spectrum Emission Mask] | Press the MEASURE hot key. Press the RF Analysis soft key. Press the Spectrum Emission Mask soft key. |

GSM Spectrum Emission Mask Measurement Procedure

MEASURE SETUP



n MISCELLANEOUS

- Y **DELAY:** Sets the delay in micro seconds. This key is used only when there is a time offset in the signals to be measured.

Setting Limit



This hot key is used to set the threshold value for the limit line on the display screen. It turns on or off the limit or band limit settings of the measurement for pass/fail indication. The user input window must be inactive first to get the Limit hot key function other than the number input.

| Step | Description |
|--|--|
| 1. Select the limit LIMIT [RF Test Limits] [Spectrum Emission Mask] [Test Limit] <On> or <Off> | Press the LIMIT hot key. Press the RF Test Limits soft key. Press the Spectrum Emission Mask soft key. Press the Test Limit soft key to toggle between On and Off and select one. |
| 2. Enable beep LIMIT [Beep] <On> or <Off> | Press the LIMIT hot key. Press the Beep soft key to toggle between On and Off and select one. This will make audible alarm if the measurement beyond the limit. |

- n **TEST LIMIT:** Enables or disables Pass/Fail results on the display screen. Toggle the **Test Limit** soft key to set it to **On** or **Off**.

Measurement Example

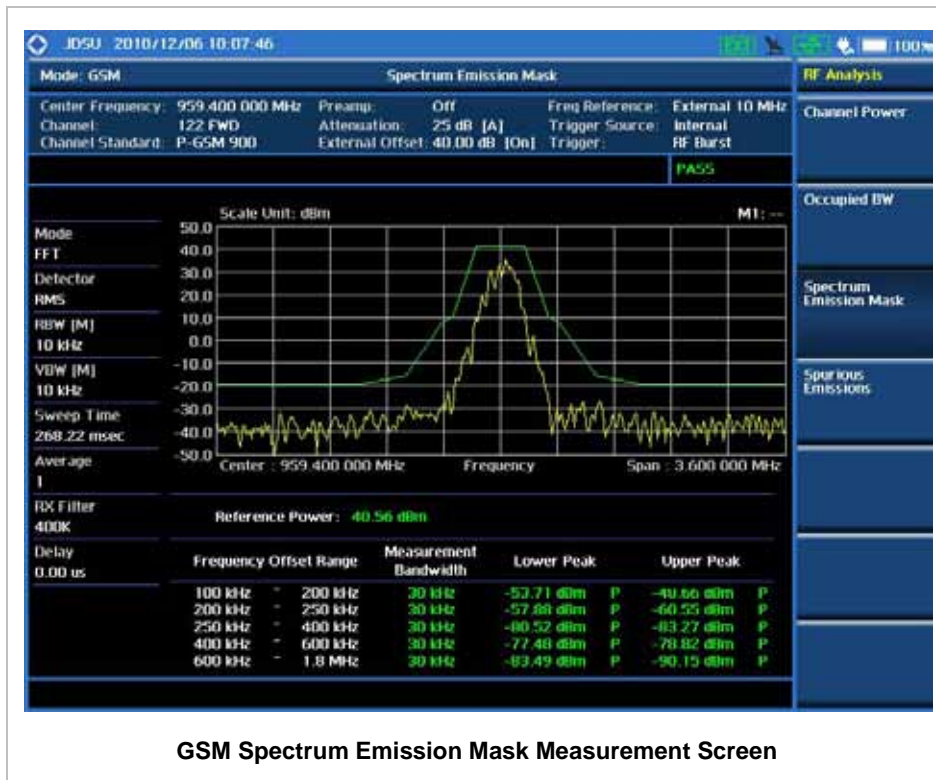

SPURIOUS EMISSIONS

Out-of-band emissions are unwanted emissions immediately outside the channel bandwidth resulting from the modulation process and non-linearity in the transmitter but excluding spurious emissions. The Spurious Emissions measurement is to identify and determine the power level of out-of-band spurious emission within the necessary channel bandwidth and modulated signal measured at the RF port of the Base Station.

Measurement Procedure

| Step | Description |
|--|--|
| 1. Set the measurement mode MEASURE [RF Analysis] [Spurious Emissions] | Press the MEASURE hot key. Press the RF Analysis soft key. Press the Spurious Emissions soft key. |
| 2. Set the measurement parameters MEASURE SETUP [Range Table] [Range] | Press the MEASURE SETUP hot key. Press the Range Table soft key. Press the Range soft key. |

| | |
|---|--|
| Enter a value [Enter] [Start Frequency] | Use the numeric keys to select the range number. Press the Enter soft key. Press the Start Frequency soft key. |
| Enter a value [GHz], [MHz], [kHz], or [Hz] [Stop Frequency] | Use the numeric keys. Press one of the unit soft keys to select. Press the Stop Frequency soft key. |
| Enter a value [GHz], [MHz], [kHz], or [Hz] [Start Limit] | Use the numeric keys. Press one of the unit soft keys to select. Press the Start Limit soft key. |
| Enter a value [dBm] [Stop Limit] | Use the numeric keys. Press the unit soft key to complete the input. Press the Stop Limit soft key. |
| Enter a value [dBm] [Attenuation] | Use the numeric keys. Press the unit soft key to complete the input. Press the Attenuation soft key. |
| Enter a value [dB] or ENTER [RBW] | Use the numeric keys to enter input value in the multiple of 5. Press the dB unit soft key or the ENTER hard key. Press the RBW soft key. |
| Enter a value [GHz], [MHz], [kHz], or [Hz] [VBW] | Use the numeric keys. Press one of the unit soft keys to select. Press the VBW soft key. |
| Enter a value [GHz], [MHz], [kHz], or [Hz] [Measure Type] | Use the numeric keys. Press one of the unit soft keys to select. Press the Measure Type soft key to toggle between Examine and Full . |
| <Examine> or <Full> [Average] | |
| Enter a value [Enter] or ENTER | Press the Average soft key. Use the numeric keys to enter a value. Press the Enter soft key or the ENTER hard key. |

GSM Spurious Emissions Measurement Procedure

MEASURE SETUP



Sets the measurement parameters including range table and measurement type. The measurement settings can be saved and recalled as a file. Also, JDViewer, PC application software allows the user to set the parameters in the user's computer to import into the instrument.

n **RANGE TABLE:** Sets the range table parameters.

Y **RANGE:** Adds a new range number or selects one of the existing range numbers to show or hide the particular frequency range in the range table at the bottom of the screen. Use the numeric keys to enter a range number and press the **Enter** soft key to complete the input.

Each time the **Range** soft key is press, it toggles between **On** and **Off**.

- Y **START FREQUENCY:** Sets or changes the start frequency value to be measured for the selected range number in the Range menu. Use the numeric keys to enter a value and press one of the unit soft keys.
- Y **STOP FREQUENCY:** Sets or changes the stop frequency value to be measured for the selected range number in the Range menu. Use the numeric keys to enter a value and press one of the unit soft keys.
- Y **START LIMIT:** Sets the start value of the limit line for the displayed range.
- Y **STOP LIMIT:** Sets the stop value of the limit line for the displayed range.
- Y **ATTENUATION:** Sets the attenuation value in the multiple of 5.
- Y **RBW:** Sets the resolution bandwidth for the selected range number in the Range menu.
- Y **VBW:** Sets the video bandwidth for the selected range number in the Range menu.
- n **MEASURE TYPE:** Sets the measurement type to **Examine** or **Full**. Toggle between **Examine** and **Full**. Examine mode will show selected range only. The instrument will automatically switch and show all ranges when Full is selected.
- n **RANGE:** Selects the range number to be displayed on the screen. This key is activated only when the **Measure Type** is set to **Examine** mode. Use the numeric keys to select one of the existing range numbers that are configured in the Range Table menu. Pressing the **Enter** soft key completes the input and changes the display.
- n **AVERAGE:** Sets the frequency the number of trace to be averaged.

Setting Limit



This hot key is used to set the threshold value for the limit line on the display screen. It turns on or off the limit or band limit settings of the measurement for pass/fail indication. The user input window must be inactive first to get the Limit hot key function other than the number input.

| Step | Description |
|--|--|
| 1. Select the limit LIMIT [RF Test Limits] [Spurious Emissions] [Test Limit] <On> or <Off> | Press the LIMIT hot key. Press the RF Test Limits soft key. Press the Spurious Emissions soft key. Press the Test Limit soft key to toggle between On and Off and select one. |

| | |
|--|---|
| <p>2. Enable beep</p> <p>LIMIT</p> <p>[Beep]</p> <p><On> or <Off></p> | <p>Press the LIMIT hot key.</p> <p>Press the Beep soft key to toggle between On and Off and select one. This will make audible alarm if the measurement result goes beyond the limit.</p> |
|--|---|

- n **TEST LIMIT:** Enables or disables Pass/Fail results on the display screen. Toggle the **Test Limit** soft key to set it to **On** or **Off**.

Measurement Example

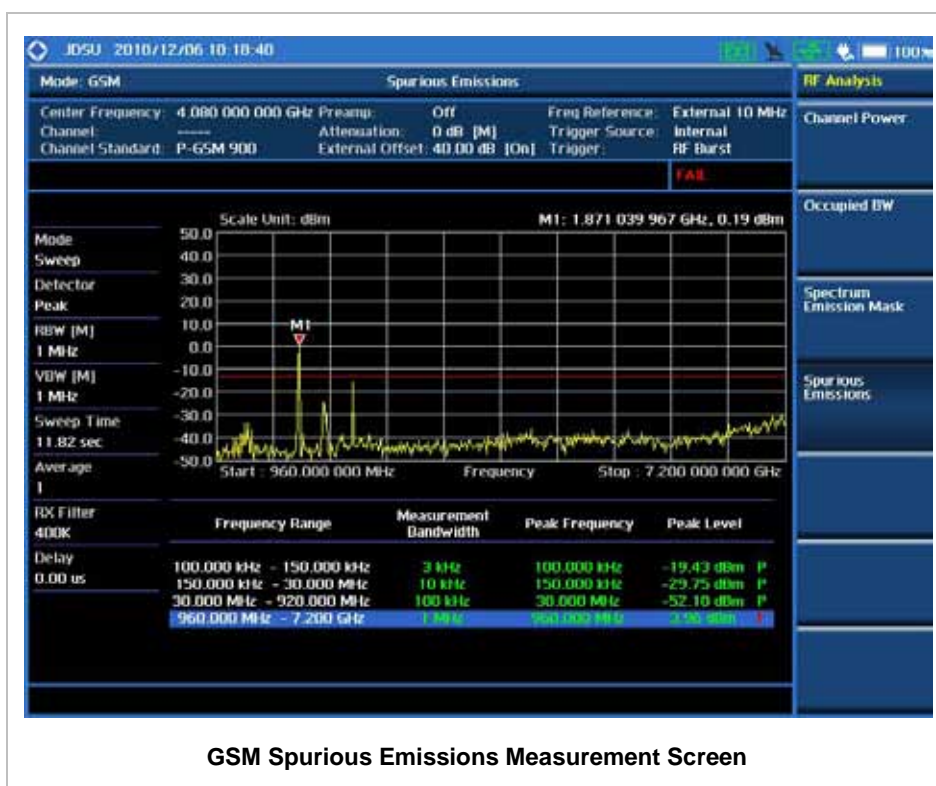

POWER VS TIME ANALYSIS MEASUREMENTS

The Power vs Time measurement measures the mean transmission power during the useful part of GSM bursts and verifies that the power ramp fits within the defined mask. It also lets the user view the rise, fall, and useful part of the GSM burst.

This measurement provides masks for both of Base Transceiver Station (BTS) and Mobile Station (MS). The timing masks are referenced to the transition from the bit 13 to the bit 14 of the mid-amble

training sequence. For GMSK measurements, the 0 dB reference is determined by measuring the mean transmitted power during the useful part of the burst.

GSM/GPRS/EDGE Power vs Time measurement provides following measurements.

- n Power vs Time (Slot)
- n Power vs Time (Frame)

Setting Mode

| Step | Description |
|---|---|
| 1. Connect the cable | Connect a cable directly or indirectly as shown in the Connecting a Cable on page 6 of this chapter. |
| 2. Select the mode MODE [Signal Analyzer] [GSM] [Power vs Time] [Power vs Time (Slot)] or [Power vs Time (Frame)] | Press the MODE hard key. Press the Signal Analyzer soft key. Press the GSM soft key. Press the Power vs Time soft key. Press one of the measurement mode soft keys to select. |

Setting Frequency

| Step | Description |
|---|--|
| 1. Set the frequency FREQ/DIST [Unit] <Freq> or <Channel> <u>When Freq is selected:</u> [Center Frequency] Enter a value [GHz], [MHz], [kHz], or [Hz] <u>When Channel is selected:</u> [Channel Standard] Select a channel standard | Press the FREQ/DIST hard key. Press the Unit soft key. Toggle this key between Freq and Channel . A set of Freq/Dist screen menu changes accordingly. Press the Center Frequency soft key. Use the numeric keys, the rotary knob, or the arrow keys. When using the numeric keys, the input is completed by selecting one of the unit soft keys. Press the Channel Standard soft key. Press the arrow keys, rotate the knob, or press the Page Up and Page Down soft keys to highlight a frequency band to |

| | |
|---|--|
| <p>[Select] or ENTER</p> | <p>select. Press the Select soft key or the ENTER hard key.</p> |
| <p>[Channel Number] Enter a value [Forward]</p> | <p>Press the Channel Number soft key. Use the numeric keys to input value and press the Forward soft key to complete the input. The instrument automatically displays its corresponding center frequency value for the channel number.</p> |

FREQ/DIST



- n **UNIT:** Determines the way how to set the frequency band either with standard band or custom frequency band. Toggling this key between **Freq** and **Channel** changes a set of Freq/Dist screen menu automatically.
- n **CENTER FREQUENCY:** Changes the center frequency setting. Use the rotary knob or the arrow keys. Or use the numeric keys to input a certain value and press one of the unit soft keys to complete the input.
- n **FREQUENCY STEP:** Defines the amount of frequency to be increased or decreased when using the rotary knob or the arrow keys to change the **Center Frequency**. This frequency step size can be entered by using numeric keys and the unit soft keys.
- n **CHANNEL NUMBER:** Enters a channel number. The instrument automatically displays its corresponding center frequency value for the channel number.
- n **CHANNEL STEP:** Defines the amount of channel to be increased or decreased when using the rotary knob or the arrow keys to change the **Channel Number**. This channel step size can be entered by using numeric keys and the **Enter** soft key.
- n **CHANNEL STANDARD:** When the channel standard is selected from the list, the center frequency information on the display screen will be mapped accordingly to the selected channel standard. The channel standards available in the instrument are listed in the Appendix C – Band, Frequency & Channel Standard.

Setting Amplitude

| Step | Description |
|--|--|
| <p>1. Set the reference/attenuation level AMP/SCALE [Auto Scale]</p> | <p>Press the AMP/SCALE hard key. Press the Auto Scale soft key to automatically set optimum levels of reference and attenuation.</p> |

| | |
|--|---|
| or | |
| [Reference Level] Enter a reference level value | Press the Reference Level soft key to set manually. Use the numeric keys or the rotary knob that changes in a 10 dB step. |
| [dBm] or ENTER | Press the dBm soft key or the ENTER hard key. |
| [Attenuation] <Manual> Enter an attenuation value | Press the Attenuation soft key. The Auto mode is set by default. This key toggles between the Auto and Manual . Press the Attenuation soft key to highlight the Manual mode and change the attenuation value to optimize S/N. Use the numeric keys or the rotary knob that changes in a 5 dB step. The attenuation setting range is 0 to 50 dB. |

AMP/SCALE



- n **AUTO SCALE:** The instrument can automatically set the scale to the minimum and maximum values on the Y-axis of the graph for optimum display of the traces measured. Each time the **Auto Scale** is selected, the top and bottom scales are set to the minimum and maximum values with margin on the Y-axis of the display screen.
- n **REFERENCE LEVEL:** Sets the maximum Y-axis range.
- n **ATTENUATION**
 - Y **AUTO:** Input attenuator's value is automatically set depending on the reference level. This is the default operation mode, so it is recommended to use this mode unless a special measurement condition is needed.
 - Y **MANUAL:** Sets the attenuator's value for the **Spectrum Analyzer RF In 50 Ω** port.
- n **PREAMP:** Turns on or off the internal pre-amplifier. Preamp results in a correction being applied to compensate for the gain of the preamp so that amplitude readings show the value at the input connector. This soft key toggles between the **On** and **Off**. When it is set to On, the allowable attenuation input range is from 0 dB to 10 dB in a multiple of 5. If the attenuation value is manually set greater than 10 dB, the instrument will automatically turn off the pre-amplifier to display low level signal properly on the screen.
- n **EXTERNAL OFFSET:** Sets an external offset value. An offset consists of a cable loss and a user offset and the measurement result shows the value reflecting both offset values. When the external offset value is set at 40 dB in the Spectrum mode, the measurement result compensates 40 dB at both the Spectrum Analyzer and Signal Analyzer modes.

Setting Averaging

BW/AVG 

- n **AVERAGE:** Sets the number of measurements to be averaged for the trace presentation. A maximum of 100 times of averaging can be set.

| Step | Description |
|---|--|
| 1. Set the averaging BW/AVG [Average] | Press the BW/AVG hard key. Press the Average soft key. |
| 2. Enter number of averaging to set | Use the numeric keys and input a number between 1 and 100. When the averaging reaches to the number set here, a new measurement value replaces the earliest measurement value in sequence. |
| 3. [Enter] or ENTER | Press the Enter soft key or the ENTER hard key. |

Setting Sweep Mode

SWEEP 

This hot key is used to set the sweep parameters. The user input window must be inactive first to get the Sweep hot key function other than the number input.

- n **SWEEP MODE:** Sets the sweep method. Toggle between **Continue** and **Single**.

| Step | Description |
|--|---|
| 1. Set the sweep mode SWEEP [Sweep Mode] | Press the SWEEP hot key. Press the Sweep Mode soft key. Toggle between Continue and Single . |

Setting Trigger Level

TRIGGER 

This hot key is used to select the trigger level among **RF Burst**, **Internal FB**, **RF Burst & TS**, **External**, and **Free**. The user input window must be inactive first to get the Trigger hot key function other than the number input.

- n **RF BURST:** Sets the trigger level when using the RF Burst (wideband) trigger. The value is relative to the peak of the signal. RF Burst is also known as RF Envelope.

- n **INTERNAL FB:** Sets the trigger level to Free Burst if there is a frequency burst signal.
- n **RF BURST & TS:** Sets the trigger level to Training Sequence Code.
- n **EXTERNAL:** Sets the trigger level to external trigger reference.
- n **FREE:** Sets the free trigger (auto trigger).

POWER VS TIME (SLOT)

Measurement Procedure

| Step | Description |
|--|--|
| 1. Set the measurement mode MEASURE [Power vs Time] [Power vs Time (Slot)] | Press the MEASURE hot key. Press the Power vs Time soft key. Press the Power vs Time (Slot) soft key. |

GSM Power vs Time (Slot) Measurement Procedure

MEASURE SETUP



- n **DETECT MODE:** Selects the signal standard of GSM or EDGE. Default setting is **Auto**. Each time this soft key is pressed, the selection moves.
- n **MISCELLANEOUS**
 - Y **DELAY:** Sets the delay in micro seconds. This key is used only when there is a time offset in the signals to be measured.

Setting Limit

LIMIT



This hot key is used to set the threshold value for the limit line on the display screen. It turns on or off the limit or band limit settings of the measurement for pass/fail indication. The user input window must be inactive first to get the Limit hot key function other than the number input.

| Step | Description |
|---|---|
| 1. Select the limit LIMIT [PvsT Test Limits] [Burst Power] [Test Limits] <On> or <Off> [High Limit] Enter a value [dBm] or ENTER [Low Limit] Enter a value [dBm] or ENTER | Press the LIMIT hot key. Press the PvsT Test Limits soft key. Press the Burst Power soft key. Press the Test Limits soft key to toggle between On and Off and select one. Press the High Limit soft key to set the upper limit of the Pass/Fail criteria. Use the numeric keys to input value. Press the unit soft key or the ENTER hard key. Press the Low Limit soft key to set the lower limit of the Pass/Fail criteria. Use the numeric keys to input value. Press the unit soft key or the ENTER hard key. |
| 2. Enable beep LIMIT [Beep] <On> or <Off> | Press the LIMIT hot key. Press the Beep soft key to toggle between On and Off and select one. This will make audible alarm if the measurement beyond the limit. |

- n **BURST POWER:** Sets the burst power limits.
- Y **TEST LIMITS:** Enables or disables Pass/Fail results on the display screen. Toggle the **Test Limits** soft key to set it to **On** or **Off**.
- Y **HIGH LIMIT:** Sets the upper limit of the Pass/Fail criteria. Use the numeric keys to enter a threshold or limit value and press the **dBm** unit soft key or the **ENTER** hard key to complete the input.
- Y **LOW LIMIT:** Sets the lower limit of the Pass/Fail criteria. Use the numeric keys to enter a threshold or limit value and press the **dBm** unit soft key or the **ENTER** hard key to complete the input.
- n **FRAME AVERAGE POWER:** *This key is not used in the Power vs Time (Slot) mode.*

Measurement Example

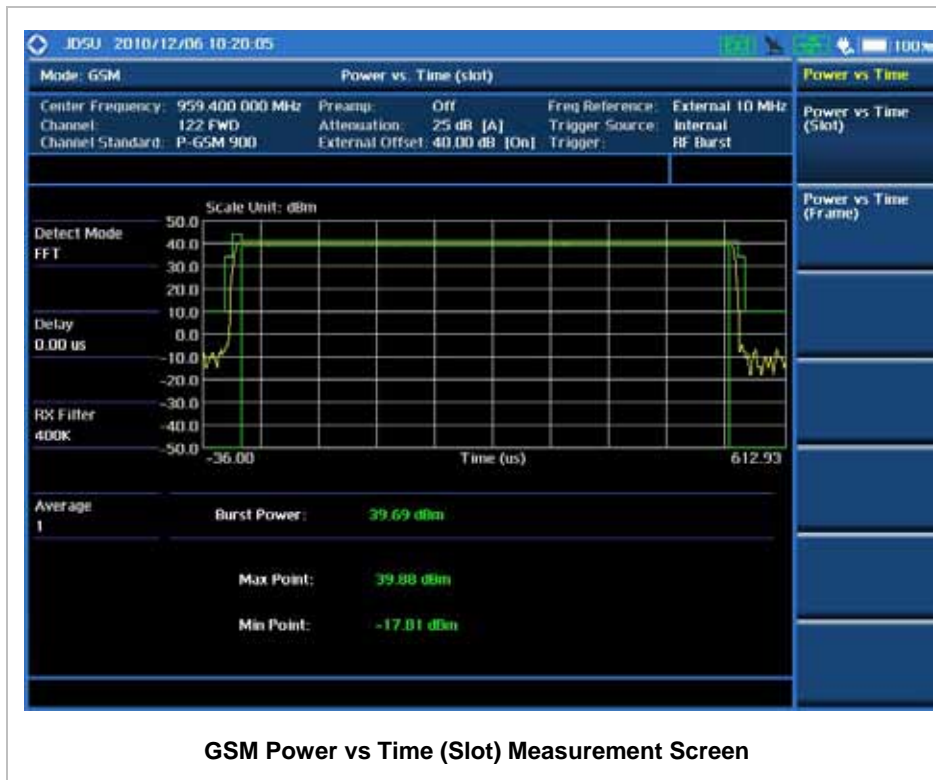

GSM Power vs Time (Slot) Measurement Screen

POWER VS TIME (FRAME)

Measurement Procedure

| Step | Description |
|---|---|
| 1. Set the measurement mode MEASURE [Power vs Time] [Power vs Time (Frame)] | Press the MEASURE hot key. Press the Power vs Time soft key. Press the Power vs Time (Frame) soft key. |

GSM Power vs Time (Frame) Measurement Procedure

MEASURE SETUP



- n **DETECT MODE:** Selects the signal standard of GSM or EDGE. Default setting is Auto. Each time this soft key is pressed, the selection moves.
- n **MISCELLANEOUS**
 - Y **DELAY:** Sets the delay in micro seconds. This key is used only when there is a time offset in the signals to be measured.

Setting Limit



This hot key is used to set the threshold value for the limit line on the display screen. It turns on or off the limit or band limit settings of the measurement for pass/fail indication. The user input window must be inactive first to get the Limit hot key function other than the number input.

| Step | Description |
|--|---|
| 1. Select the limit LIMIT [PvsT Test Limits] [Frame Average Power] [Test Limits] <On> or <Off> [High Limit] Enter a value [dBm] or ENTER [Low Limit] Enter a value [dBm] or ENTER | Press the LIMIT hot key. Press the PvsT Test Limits soft key. Press the Frame Average Power soft key. Press the Test Limits soft key to toggle between On and Off and select one. Press the High Limit soft key to set the upper limit of the Pass/Fail criteria. Use the numeric keys to input value. Press the unit soft key or the ENTER hard key. Press the Low Limit soft key to set the lower limit of the Pass/Fail criteria. Use the numeric keys to input value. Press the unit soft key or the ENTER hard key. |
| 2. Enable beep LIMIT [Beep] <On> or <Off> | Press the LIMIT hot key. Press the Beep soft key to toggle between On and Off and select one. This will make audible alarm if the measurement beyond the limit. |

- n **BURST POWER:** This key is not used in the Power vs Time (Frame) mode.
- n **FRAME AVERAGE POWER:** Sets the frame average power limits.
- Y **TEST LIMITS:** Enables or disables Pass/Fail results on the display screen. Toggle the **Test Limits** soft key to set it to **On** or **Off**.
- Y **HIGH LIMIT:** Sets the upper limit of the Pass/Fail criteria. Use the numeric keys to enter a threshold or limit value and press the **dBm** unit soft key or the **ENTER** hard key to complete the input.
- Y **LOW LIMIT:** Sets the lower limit of the Pass/Fail criteria. Use the numeric keys to enter a threshold or limit value and press the **dBm** unit soft key or the **ENTER** hard key to complete the input.

Measurement Example

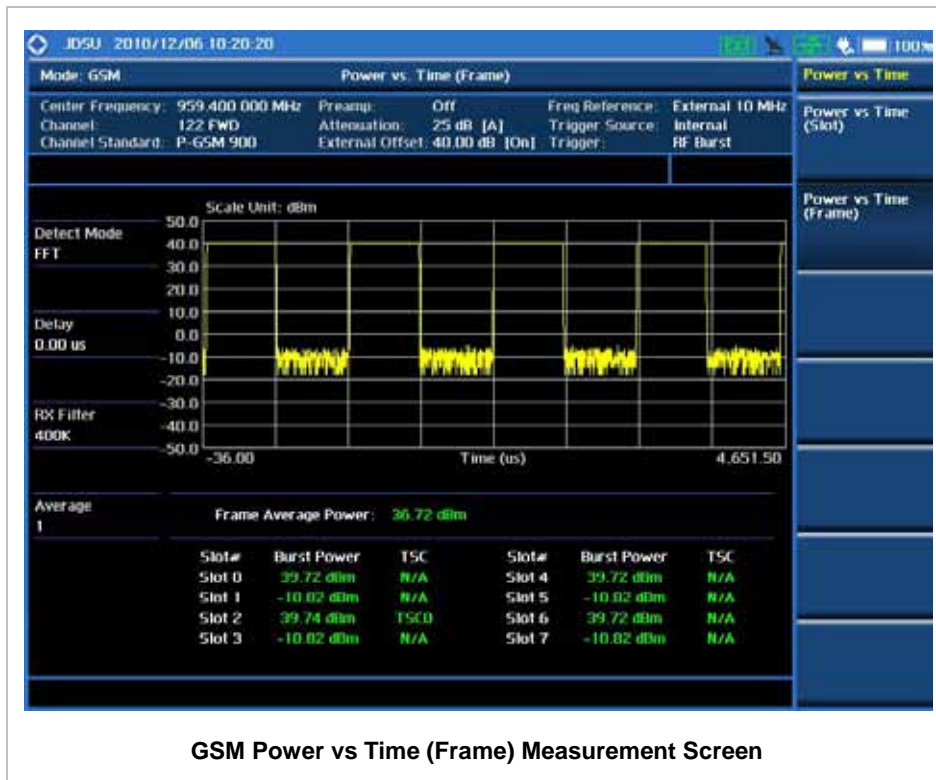

GSM Power vs Time (Frame) Measurement Screen

MODULATION ANALYSIS MEASUREMENT

Modulation Analysis in GSM/GPRS/EDGE Signal Analyzer provides single-button measurements for the following essential measurement.

- n Constellation

Setting Mode

| Step | Description |
|---|---|
| 1. Connect the cable | Connect a cable directly or indirectly as shown in the Connecting a Cable on page 6 of this chapter. |
| 2. Select the mode MODE [Signal Analyzer] [GSM] [Constellation] | Press the MODE hard key. Press the Signal Analyzer soft key. Press the GSM soft key. Press the Constellation soft key. |

Setting Frequency

| Step | Description |
|---|--|
| <p>1. Set the frequency</p> <p>FREQ/DIST</p> <p>[Unit] <Freq> or <Channel></p> <p><i>When Freq is selected:</i></p> <p>[Center Frequency] Enter a value [GHz], [MHz], [kHz], or [Hz]</p> <p><i>When Channel is selected:</i></p> <p>[Channel Standard] Select a channel standard</p> <p>[Select] or ENTER</p> <p>[Channel Number] Enter a value [Forward]</p> | <p>Press the FREQ/DIST hard key.</p> <p>Press the Unit soft key. Toggle this key between Freq and Channel. A set of Freq/Dist screen menu changes accordingly.</p> <p>Press the Center Frequency soft key. Use the numeric keys, the rotary knob, or the arrow keys. When using the numeric keys, the input is completed by selecting one of the unit soft keys.</p> <p>Press the Channel Standard soft key. Press the arrow keys, rotate the knob, or press the Page Up and Page Down soft keys to highlight a frequency band to select.</p> <p>Press the Select soft key or the ENTER hard key.</p> <p>Press the Channel Number soft key. Use the numeric keys to input value and press the Forward soft key to complete the input. The instrument automatically displays its corresponding center frequency value for the channel number.</p> |

FREQ/DIST



- n **UNIT:** Determines the way how to set the frequency band either with standard band or custom frequency band. Toggling this key between **Freq** and **Channel** changes a set of Freq/Dist screen menu automatically.
- n **CENTER FREQUENCY:** Changes the center frequency setting. Use the rotary knob or the arrow keys. Or use the numeric keys to input a certain value and press one of the unit soft keys to complete the input.
- n **FREQUENCY STEP:** Defines the amount of frequency to be increased or decreased when using the rotary knob or the arrow keys to change the **Center Frequency**. This frequency step size can be entered by using numeric keys and the unit soft keys.
- n **CHANNEL NUMBER:** Enters a channel number. The instrument automatically displays its

corresponding center frequency value for the channel number.

- n **CHANNEL STEP:** Defines the amount of channel to be increased or decreased when using the rotary knob or the arrow keys to change the **Channel Number**. This channel step size can be entered by using numeric keys and the **Enter** soft key.
- n **CHANNEL STANDARD:** When the channel standard is selected from the list, the center frequency information on the display screen will be mapped accordingly to the selected channel standard. The channel standards available in the instrument are listed in the Appendix C – Band, Frequency & Channel Standard.

Setting Amplitude

| Step | Description |
|---|--|
| 1. Set the attenuation level AMP/SCALE [Auto Scale] | Press the AMP/SCALE hard key. Press the Auto Scale soft key to automatically set optimum attenuation level. |
| or | |
| [Attenuation] <Manual> | Press the Attenuation soft key. The Auto mode is set by default. This key toggles between the Auto and Manual . Press the Attenuation soft key to highlight the Manual mode and change the attenuation value to optimize S/N. |
| Enter an attenuation value | Use the numeric keys or the rotary knob that changes in a 5 dB step. The attenuation setting range is 0 to 50 dB. |

AMP/SCALE



- n **AUTO SCALE:** The instrument can automatically set the scale to the minimum and maximum values on the Y-axis of the graph for optimum display of the traces measured. Each time the **Auto Scale** is selected, the top and bottom scales are set to the minimum and maximum values with margin on the Y-axis of the display screen.
- n **ATTENUATION**
 - Y **AUTO:** Input attenuator's value is automatically set depending on the reference level. This is the default operation mode, so it is recommended to use this mode unless a special measurement condition is needed.
 - Y **MANUAL:** Sets the attenuator's value for the **Spectrum Analyzer RF In 50 Ω** port.
- n **PREAMP:** Turns on or off the internal pre-amplifier. Preamp results in a correction being applied

to compensate for the gain of the preamp so that amplitude readings show the value at the input connector. This soft key toggles between the **On** and **Off**. When it is set to **On**, the allowable attenuation input range is from 0 dB to 10 dB in a multiple of 5. If the attenuation value is manually set greater than 10 dB, the instrument will automatically turn off the pre-amplifier to display low level signal properly on the screen.

- n **EXTERNAL OFFSET:** Sets an external offset value. An offset consists of a cable loss and a user offset and the measurement result shows the value reflecting both offset values. When the external offset value is set at 40 dB in the Spectrum mode, the measurement result compensates 40 dB at both the Spectrum Analyzer and Signal Analyzer modes.

Setting Averaging



- n **AVERAGE:** Sets the number of measurements to be averaged for the trace presentation. A maximum of 100 times of averaging can be set.

| Step | Description |
|---|--|
| 1. Set the averaging BW/AVG [Average] | Press the BW/AVG hard key. Press the Average soft key. |
| 2. Enter number of averaging to set | Use the numeric keys and input a number between 1 and 100. When the averaging reaches to the number set here, a new measurement value replaces the earliest measurement value in sequence. |
| 3. [Enter] or ENTER | Press the Enter soft key or the ENTER hard key. |

Setting Display



- n **DEMOD BITS:** Enables or disables the demodulation bits analysis. Toggle between **On** and **Off**. The measurement display screen changes to demodulation bits when it turns on.

Setting Sweep Mode



This hot key is used to set the sweep parameters. The user input window must be inactive first to get the Sweep hot key function other than the number input.

- n **SWEEP MODE:** Sets the sweep method. Toggle between **Continue** and **Single**.

| Step | Description |
|--|---|
| 1. Set the sweep mode SWEEP [Sweep Mode] | Press the SWEEP hot key. Press the Sweep Mode soft key. Toggle between Continue and Single . |

Setting Trigger Level



This hot key is used to select the trigger level among **RF Burst**, **Internal FB**, **RF Burst & TS**, **External**, and **Free**. The user input window must be inactive first to get the Trigger hot key function other than the number input.

- n **RF BURST:** Sets the trigger level when using the RF Burst (wideband) trigger. The value is relative to the peak of the signal. RF Burst is also known as RF Envelope.
- n **INTERNAL FB:** Sets the trigger level to Free Burst if there is a frequency burst signal.
- n **RF BURST & TS:** Sets the trigger level to Training Sequence Code.
- n **EXTERNAL:** Sets the trigger level to external trigger reference.
- n **FREE:** Sets the free trigger (auto trigger).

CONSTELLATION

The Constellation is used to observe some aspects of modulation accuracy and can reveal certain fault mechanisms such as I/Q amplitude imbalance or quadrature imbalance. It displays constellation diagram by modulation types.

Measurement Procedure

| Step | Description |
|---|---|
| 1. Set the measurement mode MEASURE [Constellation] | Press the MEASURE hot key. Press the Constellation soft key. |

GSM Constellation Measurement Procedure

MEASURE SETUP



- n **DETECT MODE:** Selects the signal standard of GSM or EDGE. Default setting is Auto. Each time this soft key is pressed, the selection moves.
- n **PSK CONSTELLATION:** Sets the PSK constellation observation mode to on or off. Toggle this soft key between **On** and **Off**. This setting should be on to analyze EDGE signals.
- n **MISCELLANEOUS**
 - Y **DELAY:** Sets the delay in micro seconds. This key is used only when there is a time offset in the signals to be measured.

Setting Limit

LIMIT



This hot key is used to set the threshold value for the limit line on the display screen. It turns on or off the limit or band limit settings of the measurement for pass/fail indication. The user input window must be inactive first to get the Limit hot key function other than the number input.

| Step | Description |
|--|---|
| 1. Select the limit LIMIT [Modulation Test Limits] [Frequency Error] [Test Limits] <On> or <Off> [High Limit] [Low Limit] [Phase Error RMS] [Test Limits] <On> or <Off> [High Limit] | Press the LIMIT hot key. Press the Modulation Test Limits soft key. Press the Frequency Error soft key. Press the Test Limits soft key. Toggle between On and Off . Use the numeric keys and enter a value. Use the numeric keys and enter a value. Press the Phase Error RMS soft key. Press the Test Limits soft key. Toggle between On and Off . Use the numeric keys and enter a value. |

| | |
|---|--|
| <p>[Low Limit]</p> <p>[Phase Error Peak]</p> <p>[Test Limits] <On> or <Off></p> <p>[High Limit]</p> <p>[Low Limit]</p> <p>[EVM RMS]</p> <p>[Test Limit] <On> or <Off></p> <p>[High Limit]</p> <p>[EVM Peak]</p> <p>[Test Limit] <On> or <Off></p> <p>[High Limit]</p> <p>[IQ Origin Offset]</p> <p>[Test Limit] <On> or <Off></p> <p>[High Limit]</p> <p>[C/I]</p> <p>[Test Limit] <On> or <Off></p> <p>[Low Limit]</p> | <p>Use the numeric keys and enter a value.</p> <p>Press the Phase Error Peak soft key.</p> <p>Press the Test Limits soft key. Toggle between On and Off.</p> <p>Use the numeric keys and enter a value.</p> <p>Use the numeric keys and enter a value.</p> <p>Press the EVM RMS soft key.</p> <p>Press the Test Limit soft key. Toggle between On and Off.</p> <p>Use the numeric keys and enter a value.</p> <p>Press the EVM Peak soft key.</p> <p>Press the Test Limit soft key. Toggle between On and Off.</p> <p>Press the IQ Origin Offset soft key.</p> <p>Press the Test Limit soft key. Toggle between On and Off.</p> <p>Use the numeric keys and enter a value.</p> <p>Press the C/I soft key to set Carrier to Interference ratio.</p> <p>Press the Test Limit soft key. Toggle between On and Off.</p> <p>Use the numeric keys and enter a value.</p> |
| <p>2. Enable beep</p> <p>LIMIT</p> <p>[Beep] <On> or <Off></p> | <p>Press the LIMIT hot key.</p> <p>Press the Beep soft key to toggle between On and Off and select one. This will make audible alarm if the measurement beyond the limit.</p> |

- n **FREQUENCY ERROR:** Sets the frequency error.
- Y **TEST LIMITS:** Enables or disables the test limit(s). Toggle the **Test Limits** soft key between **On** and **Off**.
- Y **HIGH LIMIT:** Sets the upper limit. Use the numeric keys to input value and press the unit soft key or the **ENTER** hard key to complete the input.
- Y **LOW LIMIT:** Sets the lower limit. Use the numeric keys to input value and press the unit soft key or the **ENTER** hard key to complete the input.
- n **PHASE ERROR RMS:** Sets the RMS of the phase error (in degrees) between the measured

phase and the ideal phase of a TCH timeslot. The GSM standard specifies the RMS phase error not to exceed 5 degrees during the useful part of the GSM burst.

- Y **TEST LIMITS:** Enables or disables the test limit(s). Toggle the **Test Limits** soft key between **On** and **Off**.
- Y **HIGH LIMIT:** Sets the upper limit. Use the numeric keys to input value and press the **Enter** soft key or the **ENTER** hard key to complete the input.
- Y **LOW LIMIT:** Sets the lower limit. Use the numeric keys to input value and press the **Enter** soft key or the **ENTER** hard key to complete the input.
- n **PHASE ERROR PEAK:** Sets the peak of the phase error (in degrees) between the measured phase and the ideal phase of a TCH timeslot, at a single instant. The GSM standard specifies the peak phase error not to exceed 20 degrees during the useful part of the GSM burst.
 - Y **TEST LIMITS:** Enables or disables the test limit(s). Toggle the **Test Limits** soft key between **On** and **Off**.
 - Y **HIGH LIMIT:** Sets the upper limit. Use the numeric keys to input value and press the **Enter** soft key or the **ENTER** hard key to complete the input.
 - Y **LOW LIMIT:** Sets the lower limit. Use the numeric keys to input value and press the **Enter** soft key or the **ENTER** hard key to complete the input.
- n **EVM RMS:** Sets the RMS of the error vector magnitude, which is measured and calculated over the useful part of the burst, and is shown as a percentage.
 - Y **TEST LIMIT:** Enables or disables the test limit(s). Toggle the **Test Limit** soft key between **On** and **Off**.
 - Y **HIGH LIMIT:** Sets the upper limit. Use the numeric keys to input value and press the **Enter** soft key or the **ENTER** hard key to complete the input.
- n **EVM PEAK:** Sets the peak of the error vector magnitude, which is measured and calculated over the useful part of the burst, and is shown as a percentage.
 - Y **TEST LIMIT:** Enables or disables the test limit(s). Toggle the **Test Limit** soft key between **On** and **Off**.
 - Y **HIGH LIMIT:** Sets the upper limit. Use the numeric keys to input value and press the **Enter** soft key or the **ENTER** hard key to complete the input.
- n **IQ ORIGIN OFFSET:** Sets I/Q origin offset value in dB of the I and Q error (magnitude squared) offset from the origin.
 - Y **TEST LIMIT:** Enables or disables the test limit(s). Toggle the **Test Limit** soft key between **On** and **Off**.
 - Y **HIGH LIMIT:** Sets the upper limit. Use the numeric keys to input value and press the unit soft key or the **ENTER** hard key to complete the input.

- n **C/I:** Sets the Carrier to Interference (C/I) ratio in dB.
- Y **TEST LIMIT:** Enables or disables the test limit(s). Toggle the **Test Limit** soft key between **On** and **Off**.
- Y **LOW LIMIT:** Sets the lower limit. Use the numeric keys to input value and press the unit soft key or the **ENTER** hard key to complete the input.

Measurement Example

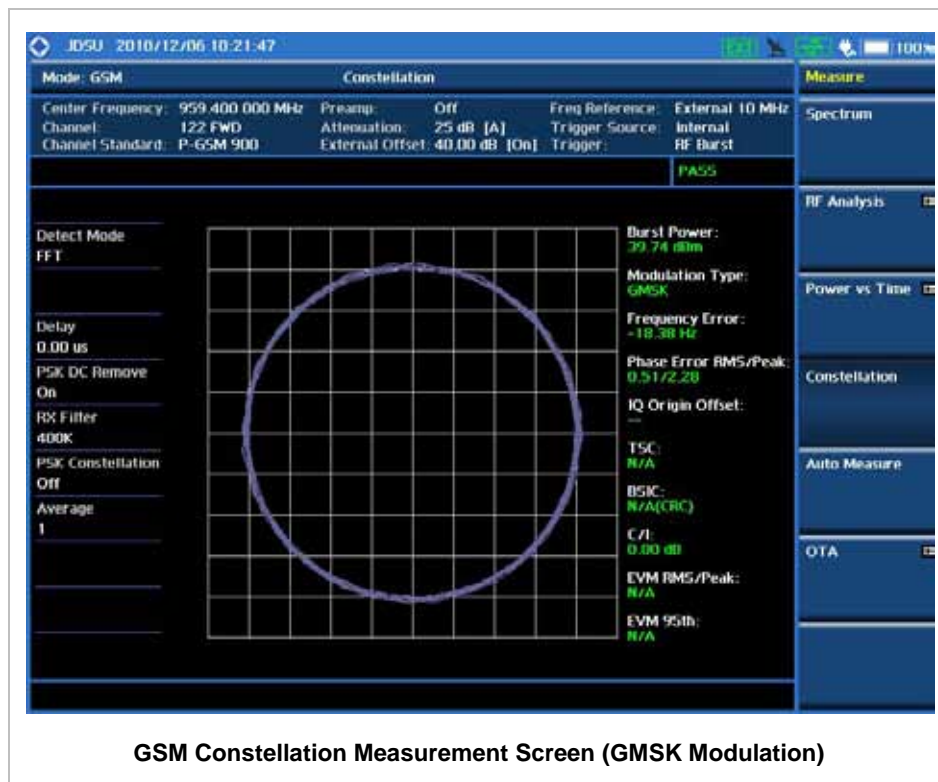

Measurement items such as IQ Origin Offset, C/I, EVM RMS/Peak and EVM 95th are applicable only to EDGE signal measurements.

AUTO MEASUREMENT

The Auto Measure function of the JD740A series allows a complete signal profiling covering RF characterization and modulation quality parameters of up to 10 different carriers, particularly useful on an overlay architecture where base stations are transmitting in different frequencies.

The Auto Measure can be easily executed either by selecting a menu in the instrument or by running a programmed scenario in the PC-based application so that the instrument automatically configure and

perform tests on every aspect of all the carriers.

Setting Mode

| Step | Description |
|--|--|
| 1. Connect the cable | Connect a cable directly or indirectly as shown in the Connecting a Cable on page 6 of this chapter. |
| 2. Select the mode MODE [Signal Analyzer] [GSM] [Auto Measure] | Press the MODE hard key. Press the Signal Analyzer soft key. Press the GSM soft key. Press the Auto Measure soft key. |

Following settings are required only when you run Auto Measure on the instrument using “Current” configuration setting. Additional settings are not required when you run Auto Measure using a scenario generated in the PC application software, JDViewer.

Setting Frequency

| Step | Description |
|--|---|
| 1. Set the frequency FREQ/DIST [Unit] <Freq> or <Channel> <i>When Freq is selected:</i> [Center Frequency] Enter a value [GHz], [MHz], [kHz], or [Hz] <i>When Channel is selected:</i> [Channel Standard] Select a channel standard [Select] or ENTER [Channel Number] | Press the FREQ/DIST hard key. Press the Unit soft key. Toggle this key between Freq and Channel . A set of Freq/Dist screen menu changes accordingly. Press the Center Frequency soft key. Use the numeric keys, the rotary knob, or the arrow keys. When using the numeric keys, the input is completed by selecting one of the unit soft keys. Press the Channel Standard soft key. Press the arrow keys, rotate the knob, or press the Page Up and Page Down soft keys to highlight a frequency band to select. Press the Select soft key or the ENTER hard key. Press the Channel Number soft key. |

| | |
|---|--|
| <p>Enter a value [Forward]</p> | <p>Use the numeric keys to input value and press the Forward soft key to complete the input. The instrument automatically displays its corresponding center frequency value for the channel number.</p> |
|---|--|

FREQ/DIST



- n **UNIT:** Determines the way how to set the frequency band either with standard band or custom frequency band. Toggling this key between **Freq** and **Channel** changes a set of Freq/Dist screen menu automatically.
- n **CENTER FREQUENCY:** Changes the center frequency setting. Use the rotary knob or the arrow keys. Or use the numeric keys to input a certain value and press one of the unit soft keys to complete the input.
- n **FREQUENCY STEP:** Defines the amount of frequency to be increased or decreased when using the rotary knob or the arrow keys to change the **Center Frequency**. This frequency step size can be entered by using numeric keys and the unit soft keys.
- n **CHANNEL NUMBER:** Enters a channel number. The instrument automatically displays its corresponding center frequency value for the channel number.
- n **CHANNEL STEP:** Defines the amount of channel to be increased or decreased when using the rotary knob or the arrow keys to change the **Channel Number**. This channel step size can be entered by using numeric keys and the **Enter** soft key.
- n **CHANNEL STANDARD:** When the channel standard is selected from the list, the center frequency information on the display screen will be mapped accordingly to the selected channel standard. The channel standards available in the instrument are listed in the Appendix C – Band, Frequency & Channel Standard.

Setting Limit

LIMIT



This hot key is used to set the threshold value for the limit line on the display screen. It turns on or off the limit or band limit settings of the measurement for pass/fail indication. The user input window must be inactive first to get the Limit hot key function other than the number input.

| Step | Description |
|--|--|
| <p>1. Set the RF test limit LIMIT</p> | <p>Press the LIMIT hot key.</p> |

| | |
|--|---|
| <p>[RF Test Limits]</p> <p>[Channel Power]</p> <p>[Test Limits] <On> or <Off></p> <p>[High Limit] Enter a value [dBm] or ENTER</p> <p>[Low Limit] Enter a value [dBm] or ENTER</p> <p>[Occupied BW]</p> <p>[Test Limit] <On> or <Off></p> <p>[High Limit] Enter a value [MHz], [kHz], or [Hz]</p> <p>[Spectrum Emission Mask]</p> <p>[Test Limit] <On> or <Off></p> <p>[Spurious Emissions]</p> <p>[Test Limit] <On> or <Off></p> | <p>Press the RF Test Limits soft key.</p> <p>Press the Channel Power soft key.</p> <p>Press the Test Limits soft key to toggle between On and Off and select one.</p> <p>Press the High Limit soft key to set the upper limit of the Pass/Fail criteria. Use the numeric keys to input value.</p> <p>Press the unit soft key or the ENTER hard key.</p> <p>Press the Low Limit soft key to set the lower limit of the Pass/Fail criteria. Use the numeric keys to input value.</p> <p>Press the unit soft key or the ENTER hard key.</p> <p>Press the Occupied BW soft key.</p> <p>Press the Test Limit soft key to toggle between On and Off and select one.</p> <p>Press the High Limit soft key to set the upper limit of the Pass/Fail criteria. Use the numeric keys to input value.</p> <p>Press the unit soft key to select.</p> <p>Press the Spectrum Emission Mask soft key.</p> <p>Press the Test Limit soft key to toggle between On and Off and select one.</p> <p>Press the Spurious Emissions soft key.</p> <p>Press the Test Limit soft key to toggle between On and Off and select one.</p> |
| <p>2. Set the Power vs Time test limit</p> <p>LIMIT</p> <p>[PvsT Test Limits]</p> <p>[Frame Average Power]</p> <p>[Test Limits] <On> or <Off></p> <p>[High Limit] Enter a value [dBm] or ENTER</p> <p>[Low Limit] Enter a value [dBm] or ENTER</p> <p>[Burst Power]</p> <p>[Test Limits] <On> or <Off></p> <p>[High Limit] Enter a value [dBm] or ENTER</p> | <p>Press the LIMIT hot key.</p> <p>Press the PvsT Test Limits soft key.</p> <p>Press the Burst Power soft key.</p> <p>Press the Test Limits soft key to toggle between On and Off and select one.</p> <p>Press the High Limit soft key to set the upper limit of the Pass/Fail criteria. Use the numeric keys to input value.</p> <p>Press the unit soft key or the ENTER hard key.</p> <p>Press the Low Limit soft key to set the lower limit of the Pass/Fail criteria. Use the numeric keys to input value.</p> <p>Press the unit soft key or the ENTER hard key.</p> <p>Press the Burst Power soft key.</p> <p>Press the Test Limits soft key to toggle between On and Off and select one.</p> <p>Press the High Limit soft key to set the upper limit of the Pass/Fail criteria. Use the numeric keys to input value.</p> <p>Press the unit soft key or the ENTER hard key.</p> |

| | |
|---|--|
| <p>[Low Limit] Enter a value [dBm] or ENTER</p> | <p>Press the Low Limit soft key to set the lower limit of the Pass/Fail criteria. Use the numeric keys to input value. Press the unit soft key or the ENTER hard key.</p> |
| <p>3. Enable beep LIMIT [Beep] <On> or <Off></p> | <p>Press the LIMIT hot key. Press the Beep soft key to toggle between On and Off and select one. This will make audible alarm if the measurement result goes beyond the limit.</p> |

- n **CHANNEL POWER:** Sets the test limit parameters.
 - Y **TEST LIMITS:** Enables or disables Pass/Fail results on the display screen. Toggle the **Test Limits** soft key to set it to **On** or **Off**.
 - Y **HIGH LIMIT:** Sets the upper limit of the Pass/Fail criteria. Use the numeric keys to enter a threshold or limit value and press the **dBm** unit soft key or the **ENTER** hard key to complete the input.
 - Y **LOW LIMIT:** Sets the lower limit of the Pass/Fail criteria. Use the numeric keys to enter a threshold or limit value and press the **dBm** unit soft key or the **ENTER** hard key to complete the input.
- n **OCCUPIED BW:** Sets the test limit parameters.
 - Y **TEST LIMIT:** Enables or disables Pass/Fail results on the display screen. Toggle the **Test Limit** soft key to set it to **On** or **Off**.
 - Y **HIGH LIMIT:** Sets the upper limit of the Pass/Fail criteria. Use the numeric keys to enter a threshold or limit value and press one of the unit soft keys to complete the input.
- n **SPECTRUM EMISSION MASK:** Sets the test limit parameter.
 - Y **TEST LIMIT:** Enables or disables Pass/Fail results on the display screen. Toggle the **Test Limit** soft key to set it to **On** or **Off**.
- n **SPURIOUS EMISSIONS:** Sets the test limit parameter.
 - Y **TEST LIMIT:** Enables or disables Pass/Fail results on the display screen. Toggle the **Test Limit** soft key to set it to **On** or **Off**.
- n **BURST POWER:** Sets the test limit parameters.
 - Y **TEST LIMITS:** Enables or disables Pass/Fail results on the display screen. Toggle the **Test Limits** soft key to set it to **On** or **Off**.
 - Y **HIGH LIMIT:** Sets the upper limit of the Pass/Fail criteria. Use the numeric keys to enter a threshold or limit value and press the **dBm** unit soft key or the **ENTER** hard key to complete the input.

- Y **LOW LIMIT:** Sets the lower limit of the Pass/Fail criteria. Use the numeric keys to enter a threshold or limit value and press the **dBm** unit soft key or the **ENTER** hard key to complete the input.
- n **FRAME AVERAGE POWER:** Sets the frame average power limits.
- Y **TEST LIMITS:** Enables or disables Pass/Fail results on the display screen. Toggle the **Test Limits** soft key to set it to **On** or **Off**.
- Y **HIGH LIMIT:** Sets the upper limit of the Pass/Fail criteria. Use the numeric keys to enter a threshold or limit value and press the **dBm** unit soft key or the **ENTER** hard key to complete the input.
- Y **LOW LIMIT:** Sets the lower limit of the Pass/Fail criteria. Use the numeric keys to enter a threshold or limit value and press the **dBm** unit soft key or the **ENTER** hard key to complete the input.

Measurement Procedure

| Step | Description |
|---|--|
| 1. Select the mode MEASURE [Auto Measure] | Press the MEASURE hot key. Press the Auto Measure soft key. |
| 2. Set the measurement parameters MEASURE SETUP [Configuration] <Current> or <Scenario> [Load Scenario] [Test Time] <Now> or <Schedule> [Set Timing] [Start Time (HH:MM)] Enter a value [HHMM] [Stop Time (HH:MM)] Enter a value [HHMM] [Time Interval] | Press the MEASURE SETUP hot key. Press the Configuration soft key to select the mode. Toggle this soft key between Current and Scenario . Press the Load Scenario soft key to load a scenario file. This key is active only when the Configuration is set to Scenario . Press the Test Time soft key to select when to run a test. Toggle this soft key between Now and Schedule . Press the Set Timing soft key. This key is activated only when the Test Time is set to Schedule. Press the Start Time soft key. Use the numeric keys to input value in HH:MM format. Press the HHMM soft key to complete the input. Press the Stop Time soft key. Use the numeric keys to input value in HH:MM format. Press the HHMM soft key to complete the input. Press the Time Interval soft key. |

| | |
|--|--|
| Enter a value [Min] | Use the numeric keys to input value in minutes. Press the Min soft key to complete the input. |
| [Save Result] [File Name] | Press the Save Result soft key. Press the File Name soft key to assign a specific name to the test result. |
| [Save to] <Internal> or <USB> | Press the Save to soft key to select where to save the test result. Toggle this soft key between Internal and USB . |
| [Save Screen] <All> or <Fail> | Press the Save Screen soft key to choose the save option. Toggle this soft key between All and Fail . This key is activated only when the Save to is set to USB . |
| [Run Test] | Press the Run Test soft key to run a test. |

GSM Auto Measurement Procedure

MEASURE SETUP



- n **RUN TEST:** Starts a test.
- n **CONFIGURATION:** Selects the measurement configuration to be used. When the **Current** is selected, the instrument runs a test using current carrier frequency (single carrier) and determines pass/fail based on the instrument's limit settings. Select the **Scenario** to run a test with a programmed scenario.
- n **LOAD SCENARIO:** Selects and loads a scenario file generated by the PC application software, JDViewer. This soft key is activated only when the **Configuration** is set to **Scenario**.
- n **TEST TIME:** Selects the test time. When **Now** is selected, the instrument runs a test only once. When **Schedule** is selected, the instrument repeats tests as defined in the **Set Timing** menu.
- n **SET TIMING:** Sets the **Start Time**, **Stop Time**, and **Time Interval** of a scheduled measurement. This soft key is activated only when the **Test Time** is set to **Schedule**.
- n **SAVE RESULT:** Sets parameters for saving measurement results. The instrument automatically saves measurement results in *.CSV format as well so that they can be imported in an application software that supports the CSV format.
 - Y **FILE NAME:** Sets the measurement result file name.
 - Y **SAVE TO:** Sets the destination where the result to be saved, **Internal** or **USB**.
 - Y **SAVE SCREEN:** Selects what results to be saved into a USB drive. Toggle this soft key between **All** for all the measurement items and **Fail** for failed items only. This key is activated only when the **Save to** is set to **USB**.
- n **EXTERNAL OFFSET:** Sets an external offset value. An offset consists of a cable loss and a user

offset and the measurement result shows the value reflecting both offset values. When the external offset value is set at 40 dB in the Spectrum mode, the measurement result compensates 40 dB at both the Spectrum Analyzer and Signal Analyzer modes.

Setting Display

TRACE/DISPLAY



- n **DISPLAY:** Changes the display option. After running automatic measurement, toggle this key between **Results** and **Settings**.
 - Y **RESULTS:** Shows actual measurement results on the display screen.
 - Y **SETTINGS:** Shows measurement parameters set for the automatic measurement.
- n **DISPLAY RESULTS:** Changes the display format of measurement results. This key becomes activated when the **Results** is set as the display option. Toggle this key between **Full** and **Quick** to check measurement results in different format.
 - Y **FULL:** Shows detailed measurement results, including actual measurement readings with pass/fail color indication.
 - Y **QUICK:** Shows quick view of pass/fail results.
- n **VIEW CARRIER:** Selects a carrier to be displayed among up to 10 carriers. This key becomes activated when the **Results** is set as the display option.

GSM OTA MEASUREMENTS

This Over-The-Air (OTA) measurement has channel scanner, frequency scanner, multipath profile, and modulation analyzer screens. The GSM OTA has a function to display channel power and related information up to 128 GSM down link signals. This channel scanner can quickly identifies improper power levels that affect network performance. The transmitter performance can be made on a base station from the convenience of your vehicle without taking the base station out of service. It helps the user determine testing area's RF environmental condition with the multipath profile.

GSM/GPRS/EDGE Signal Analysis OTA provides the following measurements.

- n Channel Scanner
- n Frequency Scanner

- n Multipath Profile
- n Modulation Analyzer

Setting Mode

Connecting a GPS antenna with the instrument is a mandatory for the OTA measurements.

| Step | Description |
|--|---|
| 1. Connect the antenna | Connect antennas as shown in the Connecting a Cable on page 7 of this chapter. |
| 2. Select the mode MODE [Signal Analyzer] [GSM] [OTA] [Channel Scanner], [Frequency Scanner], [Multipath Profile], or [Modulation Analyzer] | Press the MODE hard key. Press the Signal Analyzer soft key. Press the GSM soft key. Press the OTA soft key. Press one of the measurement mode soft keys to select. |

Setting Frequency

Setting frequency described here is used in the OTA Multipath Profile mode and the OTA Modulation Analyzer mode. For the OTA Channel Scanner mode and the Frequency Scanner mode, refer to their measurement procedures.

| Step | Description |
|---|---|
| 1. Set the frequency FREQ/DIST [Unit] <Freq> or <Channel> <i>When Freq is selected:</i> [Center Frequency] Enter a value [GHz], [MHz], [kHz], or [Hz] <i>When Channel is selected:</i> | Press the FREQ/DIST hard key. Press the Unit soft key. Toggle this key between Freq and Channel . A set of Freq/Dist screen menu changes accordingly. Press the Center Frequency soft key. Use the numeric keys, the rotary knob, or the arrow keys. When using the numeric keys, the input is completed by selecting one of the unit soft keys. |

| | |
|---|--|
| <p>[Channel Standard] Select a channel standard</p> | <p>Press the Channel Standard soft key. Press the arrow keys, rotate the knob, or press the Page Up and Page Down soft keys to highlight a frequency band to select.</p> |
| <p>[Select] or ENTER</p> | <p>Press the Select soft key or the ENTER hard key.</p> |
| <p>[Channel Number] Enter a value [Forward]</p> | <p>Press the Channel Number soft key. Use the numeric keys to input value and press the Forward soft key to complete the input. The instrument automatically displays its corresponding center frequency value for the channel number.</p> |

FREQ/DIST 

- n **UNIT:** Determines the way how to set the frequency band either with standard band or custom frequency band. Toggling this key between **Freq** and **Channel** changes a set of Freq/Dist screen menu automatically.
- n **CENTER FREQUENCY:** Changes the center frequency setting. Use the rotary knob or the arrow keys. Or use the numeric keys to input a certain value and press one of the unit soft keys to complete the input.
- n **FREQUENCY STEP:** Defines the amount of frequency to be increased or decreased when using the rotary knob or the arrow keys to change the **Center Frequency**. This frequency step size can be entered by using numeric keys and the unit soft keys.
- n **CHANNEL NUMBER:** Enters a channel number. The instrument automatically displays its corresponding center frequency value for the channel number.
- n **CHANNEL STEP:** Defines the amount of channel to be increased or decreased when using the rotary knob or the arrow keys to change the **Channel Number**. This channel step size can be entered by using numeric keys and the **Enter** soft key.
- n **CHANNEL STANDARD:** When the channel standard is selected from the list, the center frequency information on the display screen will be mapped accordingly to the selected channel standard. The channel standards available in the instrument are listed in the Appendix C – Band, Frequency & Channel Standard.

Setting Amplitude

| Step | Description |
|--|---|
| <p>1. Set the reference/attenuation level AMP/SCALE</p> | <p>Press the AMP/SCALE hard key.</p> |

| | |
|--|---|
| <p>[Auto Scale]</p> <p>or</p> | <p>Press the Auto Scale soft key to automatically set optimum levels of reference and attenuation.</p> |
| <p>[Reference Level]</p> <p>Enter a reference level value</p> | <p>Press the Reference Level soft key to set manually.</p> <p>Use the numeric keys or the rotary knob that changes in a 10 dB step.</p> |
| <p>[dBm] or ENTER</p> | <p>Press the dBm soft key or the ENTER hard key.</p> |
| <p>[Attenuation]</p> | <p>Press the Attenuation soft key. The Auto mode is set by default. This key toggles between the Auto and Manual.</p> |
| <p><Manual></p> | <p>Press the Attenuation soft key to highlight the Manual mode and change the attenuation value to optimize S/N.</p> |
| <p>Enter an attenuation value</p> | <p>Use the numeric keys or the rotary knob that changes in a 5 dB step. The attenuation setting range is 0 to 50 dB.</p> |

AMP/SCALE



- n **AUTO SCALE:** The instrument can automatically set the scale to the minimum and maximum values on the Y-axis of the graph for optimum display of the traces measured. Each time the **Auto Scale** is selected, the top and bottom scales are set to the minimum and maximum values with margin on the Y-axis of the display screen.
- n **REFERENCE LEVEL:** Sets the maximum Y-axis range. *This key is not used in the Multipath Profile mode.*
- n **ATTENUATION**
 - Y **AUTO:** Input attenuator's value is automatically set depending on the reference level. This is the default operation mode, so it is recommended to use this mode unless a special measurement condition is needed.
 - Y **MANUAL:** Sets the attenuator's value for the **Spectrum Analyzer RF In 50 Ω** port.
- n **PREAMP:** Turns on or off the internal pre-amplifier. Preamp results in a correction being applied to compensate for the gain of the preamp so that amplitude readings show the value at the input connector. This soft key toggles between the **On** and **Off**. When it is set to On, the allowable attenuation input range is from 0 dB to 10 dB in a multiple of 5. If the attenuation value is manually set greater than 10 dB, the instrument will automatically turn off the pre-amplifier to display low level signal properly on the screen.
- n **UNITS:** Sets the scale unit on the display among **dBm**, **dBV**, **dBmV**, **dBuV**, **V**, and **W**.
- n **EXTERNAL OFFSET:** Sets an external offset value. An offset consists of a cable loss and a user offset and the measurement result shows the value reflecting both offset values. When the

external offset value is set at 40 dB in the Spectrum mode, the measurement result compensates 40 dB at both the Spectrum Analyzer and Signal Analyzer modes.

Setting Averaging



- n **AVERAGE:** Sets the number of measurements to be averaged for the trace presentation. A maximum of 100 times of averaging can be set.

| Step | Description |
|---|--|
| 1. Set the averaging BW/AVG [Average] | Press the BW/AVG hard key. Press the Average soft key. |
| 2. Enter number of averaging to set | Use the numeric keys and input a number between 1 and 100. When the averaging reaches to the number set here, a new measurement value replaces the earliest measurement value in sequence. |
| 3. [Enter] or ENTER | Press the Enter soft key or the ENTER hard key. |

Setting Sweep Mode



This hot key is used to set the sweep parameters. The user input window must be inactive first to get the Sweep hot key function other than the number input.

- n **SWEEP MODE:** Sets the sweep method. Toggle between **Continue** and **Single**.

| Step | Description |
|--|---|
| 1. Set the sweep mode SWEEP [Sweep Mode] | Press the SWEEP hot key. Press the Sweep Mode soft key. Toggle between Continue and Single . |

Setting Trigger Level



This hot key is used to select the trigger source among **RF Burst**, **Internal FB**, **RF Burst & TS**, **External**, and **Free**. The user input window must be inactive first to get the Trigger hot key function other than the number input.

- n **RF BURST**: Sets the trigger level when using the RF Burst (wideband) trigger. The value is relative to the peak of the signal. RF Burst is also known as RF Envelope.
- n **INTERNAL FB**: Sets the trigger level to Free Burst if there is a frequency burst signal.
- n **RF BURST & TS**: Sets the trigger level to Training Sequence Code.
- n **EXTERNAL**: Sets the trigger level to external trigger reference.
- n **FREE**: Sets the free trigger (auto trigger).

GSM OTA CHANNEL SCANNER

Measurement Procedure

| Step | Description |
|--|--|
| 1. Select the measurement mode MEASURE [OTA] [Channel Scanner] | Press the MEASURE hot key. Press the OTA soft key. Press the Channel Scanner soft key. |
| 2. Set the channel to be scanned FREQ/DIST [Channel Standard] Select a channel standard [Select] or ENTER [Start Channel] Enter a value [Enter] [Channel Step] Enter a value [Enter] or ENTER | Press the FREQ/DIST hard key. Press the Channel Standard soft key to get the pop-up window of the channel standard list. Press the arrow keys, rotate the knob, or press the Page Up and Page Down soft keys to highlight a frequency band to select. Press the Select soft key or the ENTER hard key. Press the Start Channel soft key. Use the numeric keys to input value. Press the Enter soft key. Press the Channel Step soft key. Use the numeric keys. Press the Enter soft key or the ENTER hard key. |

| | |
|---|---|
| <p>[# of Channels] Enter a value between 8 and 64 [Enter] or ENTER</p> | <p>Press the # of Channels soft key. Use the numeric keys. Press the Enter soft key or the ENTER hard key.</p> |
| <p>3. Set the measurement parameter MEASURE SETUP [Auto Save] <On> or <Off></p> | <p>Press the MEASURE SETUP hot key. Press the Auto Save soft key. Toggle between On and Off.</p> |

GSM OTA Channel Scanner Measurement Procedure

FREQ/DIST



- n **START CHANNEL:** Changes the starting channel in the channel scanner. The first channel in the full view graph changes accordingly. Values can be entered with the numeric keys and the input is completed by selecting the **Forward** soft key.
- n **CHANNEL STEP:** Sets the channel increment step size. Channels listed in the channel table on the screen increase in this step selected. Values can be entered with the numeric keys and the input is completed by pressing the **Enter** soft key or **ENTER** hard key.
- n **# OF CHANNELS:** Sets the number of channels to be scanned and displayed in the full view graph. Values from 8 to 64 can be entered with the numeric keys and the input is completed by pressing the **Enter** soft key or **ENTER** hard key.
- n **CHANNEL STANDARD:** When the channel standard is selected from the list, the start frequency information on the display screen will be mapped accordingly to the selected channel standard. The channel standards available in the instrument are listed in the Appendix C – Band, Frequency & Channel Standard.

MEASURE SETUP



- n **AUTO SAVE:** Enables or disables automatic saving of the measurement data to an external USB memory. When it turns on, the measurements will be recorded into the default file (logging.ota) or a user-named file.

Setting Display

| Step | Description |
|---|--|
| <p>1. Set the zoom position TRACE/DISPLAY [Zoom Position]</p> | <p>Press the TRACE/DISPLAY hard key. Press the Zoom Position soft key.</p> |

| | |
|-----------------------------------|--|
| Enter a value [Enter] or ENTER | Use the numeric keys to input channel to start. Press the Enter soft key or the ENTER hard key. |
|-----------------------------------|--|

TRACE/DISPLAY 

n **ZOOM POSITION:** Sets the starting channel of the Zoom In Window graph.

Measurement Example

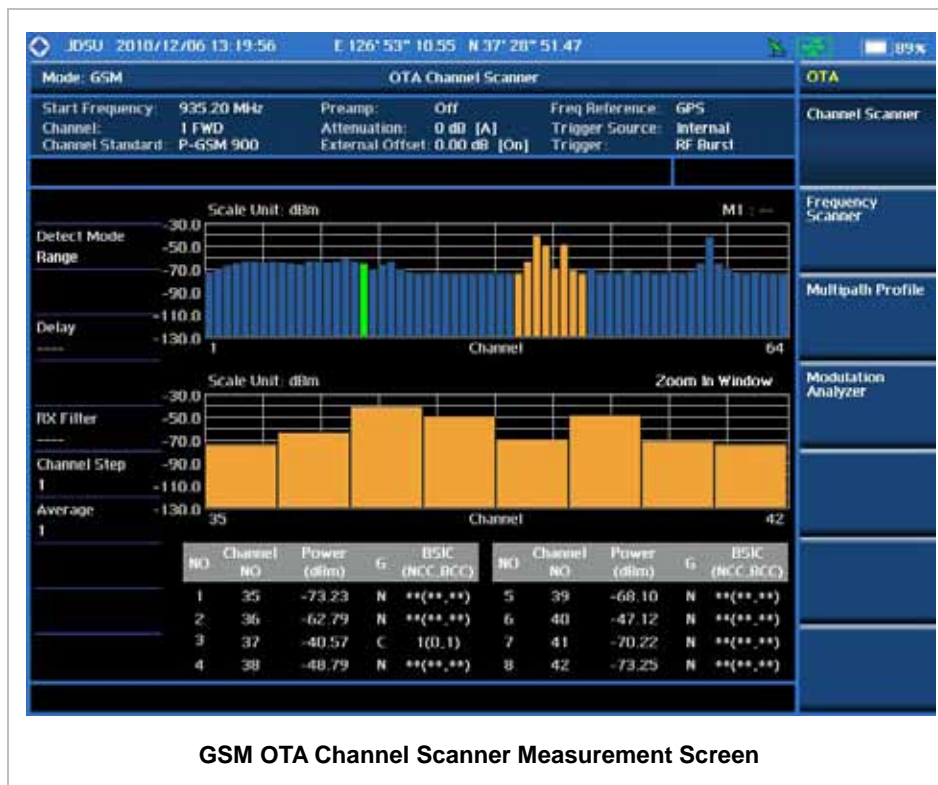

GSM OTA FREQUENCY SCANNER

Measurement Procedure

| Step | Description |
|--|---|
| 1. Select the measurement mode MEASURE [OTA] [Frequency Scanner] | Press the MEASURE hot key. Press the OTA soft key. Press the Frequency Scanner soft key. |

| | |
|---|--|
| <p>2. Set the frequency to be scanned</p> <p>FREQ/DIST</p> <p>[Start Frequency] Enter a value [MHz]</p> <p>[Frequency Step] Enter a value [Enter] or ENTER</p> <p>[# of Frequencies] Enter a value between 8 and 64 [Enter] or ENTER</p> | <p>Press the FREQ/DIST hard key.</p> <p>Press the Start Frequency soft key.</p> <p>Use the numeric keys.</p> <p>Press the unit soft key to complete the input.</p> <p>Press the Frequency Step soft key.</p> <p>Use the numeric keys.</p> <p>Press the Enter soft key or the ENTER hard key.</p> <p>Press the # of Frequencies soft key.</p> <p>Use the numeric keys.</p> <p>Press the Enter soft key or the ENTER hard key.</p> |
| <p>3. Set the measurement parameter</p> <p>MEASURE SETUP</p> <p>[Auto Save] <On> or <Off></p> | <p>Press the MEASURE SETUP hot key.</p> <p>Press the Auto Save soft key. Toggle between On and Off.</p> |

GSM OTA Frequency Scanner Measurement Procedure

FREQ/DIST



- n **START FREQUENCY:** Changes the starting frequency in the frequency scanner. The first frequency in the full view graph changes accordingly. Values can be entered with the numeric keys and the input is completed by selecting the **MHz** unit soft key.
- n **FREQUENCY STEP:** Sets the frequency increment step size. Frequencies listed in the frequency table on the screen increase in this step selected. Values can be entered with the numeric keys and the input is completed by pressing the **Enter** soft key or **ENTER** hard key.
- n **# OF FREQUENCIES:** Sets the number of frequencies to be scanned and displayed in the full view graph. Values from 8 to 64 can be entered with the numeric keys and the input is completed by pressing the **Enter** soft key or **ENTER** hard key.

MEASURE SETUP



- n **AUTO SAVE:** Enables or disables automatic saving of the measurement data to an external USB memory. When it turns on, the measurements will be recorded into the default file (logging.ota) or a user-named file.

Setting Display

| Step | Description |
|---|--|
| 1. Set the zoom position TRACE/DISPLAY [Zoom Position] Enter a value [Enter] or ENTER | Press the TRACE/DISPLAY hard key. Press the Zoom Position soft key. Use the numeric keys to input frequency to start. Press the Enter soft key or the ENTER hard key. |



n **ZOOM POSITION:** Sets the starting frequency of the Zoom In Window graph.

Measurement Example

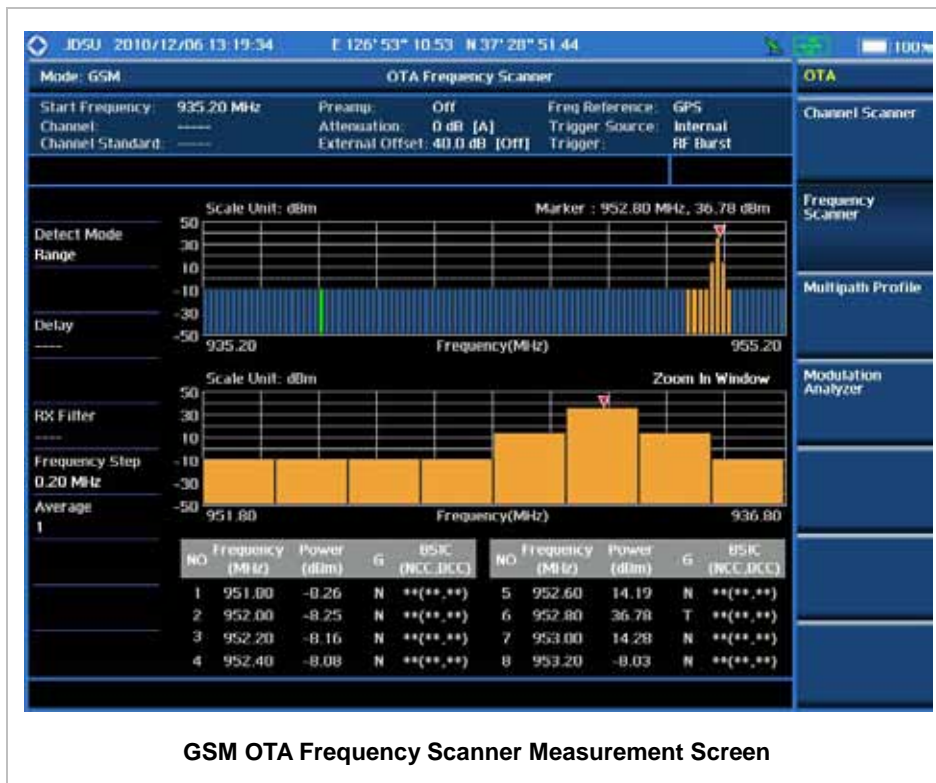

GSM OTA MULTIPATH PROFILE

The Multipath Profile enables the user to determine RF environmental conditions of testing area. The multipath profile is the result of portions of the original broadcast signal arriving at the receiving antenna out of phase. This can be caused by the signal being reflected off objects such as buildings,

or being refracted through the atmosphere differently from the main signal.

Measurement Procedure

| Step | Description |
|--|---|
| 1. Select the measurement mode MEASURE [OTA] [Multipath Profile] | Press the MEASURE hot key. Press the OTA soft key. Press the Multipath Profile soft key. |

GSM OTA Multipath Profile Measurement Procedure



MEASURE SETUP

- n **DETECT MODE:** Selects the signal standard of GSM or EDGE. Default setting is Auto. Each time this soft key is pressed, the selection moves.
- n **MISCELLANEOUS**
 - Y **DELAY:** Sets the delay in micro seconds. This key is used only when there is a time offset in the signals to be measured.

Measurement Example

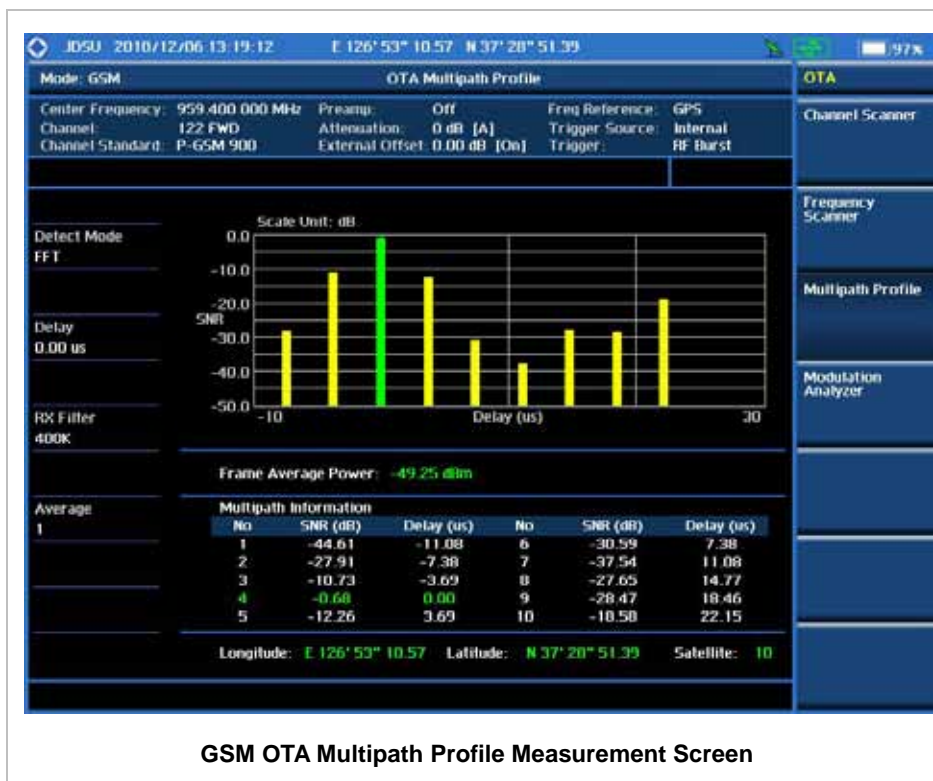

GSM OTA Multipath Profile Measurement Screen

GSM OTA MODULATION ANALYZER

Measurement Procedure

| Step | Description |
|--|---|
| 1. Select the measurement mode MEASURE [OTA] [Modulation Analyzer] | Press the MEASURE hot key. Press the OTA soft key. Press the Modulation Analyzer soft key. |
| 2. Set the measurement parameter MEASURE SETUP [Auto Save] <On> or <Off> | Press the MEASURE SETUP hot key. Press the Auto Save soft key. Toggle between On and Off . |

GSM OTA Modulation Analyzer Measurement Procedure

MEASURE SETUP



- n **AUTO SAVE:** Enables or disables automatic saving of the measurement data to an external USB memory. When it turns on, the measurements will be recorded into the default file (logging.ota) or a user-named file.
- n **DETECT MODE:** Selects the signal standard of **GSM** or **EDGE**. Default setting is **Auto**. Each time this soft key is pressed, the selection moves.
- n **MISCELLANEOUS**
 - Y **DELAY:** Sets the delay in micro seconds. This key is used only when there is a time offset in the signals to be measured.

Setting Limit

LIMIT



This hot key is used to set the threshold value for the limit line on the display screen. It turns on or off the limit or band limit settings of the measurement for pass/fail indication. The user input window must be inactive first to get the Limit hot key function other than the number input.

| Step | Description |
|---------------------|-------------|
| 1. Select the limit | |

| | |
|--|--|
| <p>LIMIT</p> <p>[Modulation Test Limits]</p> <p>[Frequency Error]</p> <p>[Test Limits]</p> <p><On> or <Off></p> <p>[High Limit]</p> <p>Enter a value</p> <p>[ppm] or ENTER</p> <p>[Low Limit]</p> <p>Enter a value</p> <p>[ppm] or ENTER</p> <p>[C/I]</p> <p>[Test Limit]</p> <p><On> or <Off></p> <p>[Low Limit]</p> <p>Enter a value</p> <p>[dB] or ENTER</p> | <p>Press the LIMIT hot key.</p> <p>Press the Modulation Test Limits soft key.</p> <p>Press the Frequency Error soft key.</p> <p>Press the Test Limits soft key. Toggle between On and Off.</p> <p>Press the High Limit soft key to set the upper limit of the Pass/Fail criteria. Use the numeric keys to input value.</p> <p>Press the unit soft key or the ENTER hard key.</p> <p>Press the Low Limit soft key to set the lower limit of the Pass/Fail criteria. Use the numeric keys to input value.</p> <p>Press the unit soft key or the ENTER hard key.</p> <p>Press the C/I soft key to set Carrier to Interference ratio.</p> <p>Press the Test Limit soft key. Toggle between On and Off.</p> <p>Press the Low Limit soft key to set the lower limit of the Pass/Fail criteria. Use the numeric keys to input value.</p> <p>Press the unit soft key or the ENTER hard key.</p> |
| <p>2. Enable beep</p> <p>LIMIT</p> <p>[Beep]</p> <p><On> or <Off></p> | <p>Press the LIMIT hot key.</p> <p>Press the Beep soft key to toggle between On and Off and select one. This will make audible alarm if the measurement beyond the limit.</p> |

- n **FREQUENCY ERROR:** Sets the frequency error.
- Y **TEST LIMITS:** Enables or disables the test limit(s). Toggle the **Test Limits** soft key between **On** and **Off**.
- Y **HIGH LIMIT:** Sets the upper limit. Use the numeric keys to input value and press the unit soft key or the **ENTER** hard key to complete the input.
- Y **LOW LIMIT:** Sets the lower limit. Use the numeric keys to input value and press the unit soft key or the **ENTER** hard key to complete the input.
- n **PHASE ERROR RMS:** *This key is not used in the OTA Modulation Analyzer mode.*
- n **PHASE ERROR PEAK:** *This key is not used in the OTA Modulation Analyzer mode.*
- n **EVM RMS:** *This key is not used in the OTA Modulation Analyzer mode.*
- n **EVM PEAK:** *This key is not used in the OTA Modulation Analyzer mode.*
- n **IQ ORIGIN OFFSET:** *This key is not used in the OTA Modulation Analyzer mode.*
- n **C/I:** Sets the Carrier to Interference (C/I) ratio in dB.
- Y **TEST LIMIT:** Enables or disables the test limit(s). Toggle the **Test Limit** soft key between **On**

and **Off**.

- Y **LOW LIMIT:** Sets the lower limit. Use the numeric keys to input value and press the unit soft key or the **ENTER** hard key to complete the input.

Measurement Example

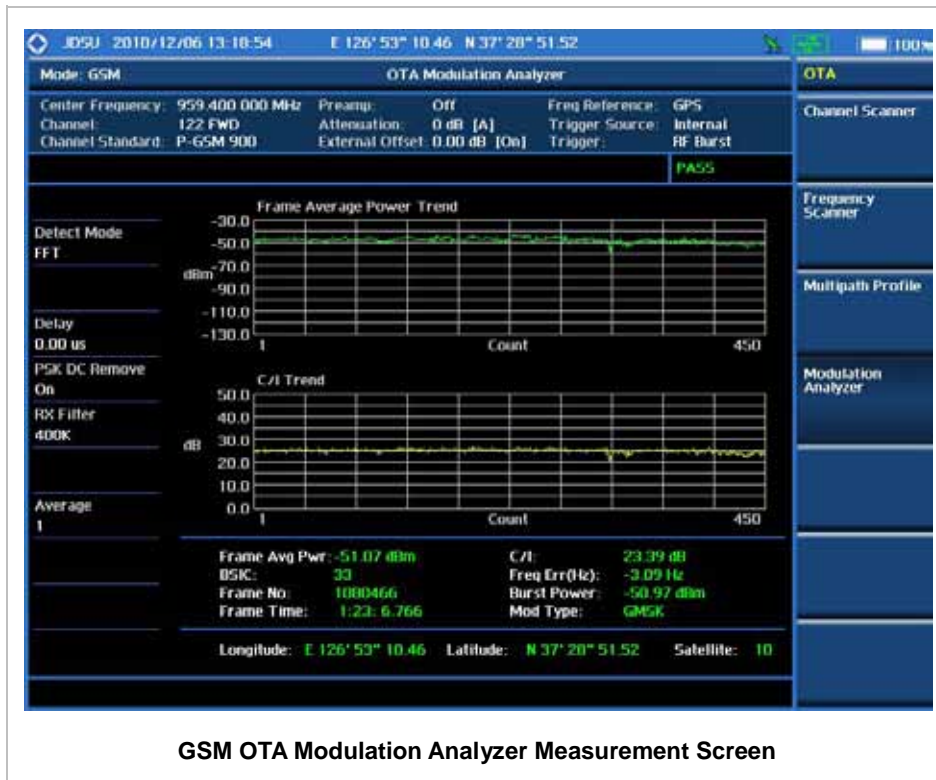

ANALYSIS

Using Marker

MARKER



Marker is used to get the information about a specific trace. Six markers can be set on the display and each marker can be used independently. The X and Y coordinates of the trace are displayed when the marker is placed on any position of the trace. The position displaying the marker's X and Y coordinates may be slightly different for each measurement mode and refer to the description of each measurement. There are three different marker types available: Normal, Delta, and Delta pair. Marker position can be set manually by entering numeric values (frequency) when one of the marker types is

selected.

- n **SELECT MARKER:** Selects an active marker whose position can be changed with the rotary knob or the arrow keys. The assigned number of the active marker is displayed in the **Select Marker** menu box and the active marker number is also displayed right next to the active marker on the trace when the **Marker View** is set to **On**.
- n **MARKER VIEW:** Displays the selected marker on the screen or hides it. When the **Marker View** is turned off and then on again in the same measurement mode, markers appear at the previous positions. If a measurement mode is changed, markers are not restored to their previous positions.
- n **NORMAL:** This Normal marker type provides the reading of a marker position on the trace along with the marker number between 1 and 6.
- n **DELTA:** This Delta marker type is associated with a Normal marker. A Normal marker must be set before a Delta marker is set. When the Delta marker is set, the position set by the Delta marker becomes the reference position of the Normal marker and the marker's X and Y values displays the difference compared with the Delta marker.
- n **DELTA PAIR:** This Delta Pair marker type is associated with a Normal marker. A Normal marker must be set before a Delta Pair marker is set. When the Delta Pair marker is set, the position set by the Delta Pair marker becomes the reference position of the Normal marker and the marker's X and Y values displays the difference compared with the Delta Pair marker. The reference position will be varied in accordance with trace change.
- n **MARKER ALL OFF:** Turns all the markers the screen off. When the Marker View is selected for those markers, the instrument displays those markers back at the previous position. If a measurement mode is changed, current settings are not restored.
- n **MARKER \rightarrow :** Sets the X coordinate of the active marker as selected.
 - Y **MARKER \rightarrow CENTER:** Sets the frequency of the active marker to the center frequency of spectrum analyzer.
 - Y **MARKER \rightarrow START:** Sets the frequency of the active marker to the start frequency of spectrum analyzer.
 - Y **MARKER \rightarrow STOP:** Sets the frequency of the active marker to the stop frequency of spectrum analyzer.

Using Peak Search

PEAK SEARCH



Each time the Peak Search soft key is pressed, the active marker is positioned at the highest peak of the trace.

- n **PEAK SEARCH:** Moves the active marker to the highest peak of the trace.
- n **NEXT PEAK:** Moves the active marker to the second highest peak of the trace.
- n **NEXT PEAK RIGHT:** Moves the active marker to the highest peak to the right of its current position.
- n **NEXT PEAK LEFT:** Moves the active marker to the highest peak to the left of its current position.
- n **MIN SEARCH:** Moves the active marker to the lowest peak of the trace.
- n **ALWAYS PEAK:** When the **Always Peak** is set to On, the instrument moves the active marker automatically to the highest peak of the trace every time the trace is refreshed.

WCDMA/HSDPA Signal Analyzer

This WCDMA/HSDPA Signal Analyzer function is optional that the JD740A series offers as the Option 023 for WCDMA and Option 024 for HSDPA. It allows the user to analyze WCDMA and HSDPA system performance. The user may alter the measurement parameters for specialized analysis. The WCDMA/HSDPA OTA Analyzer which is the Option 043 can be added to the WCDMA/HSDPA Signal Analyzer for Over The Air measurement.

In this Chapter

| | |
|---|----|
| Using WCDMA/HSDPA Signal Analyzer | 4 |
| Display Overview | 5 |
| Connecting a Cable | 7 |
| Direct Connection..... | 7 |
| Indirect Connection | 7 |
| Over The Air (OTA) | 8 |
| Spectrum Analysis Measurement..... | 9 |
| Setting Mode | 9 |
| Setting Frequency | 9 |
| Setting Amplitude | 10 |
| Setting Averaging | 12 |
| Setting Sweep Mode | 12 |
| Setting Trigger Source | 12 |
| Setting External Clock..... | 13 |
| Setting Trace and Display | 14 |
| Measurement Procedure | 15 |
| Measurement Example | 15 |
| RF Analysis Measurements..... | 15 |
| Setting Mode | 16 |
| Setting Frequency | 16 |
| Setting Amplitude | 18 |
| Setting Averaging | 19 |
| Setting Sweep Mode | 19 |
| Setting Trigger Source | 20 |
| Setting External Clock..... | 20 |
| Channel Power | 22 |
| Measurement Procedure | 22 |
| Setting Limit | 22 |
| Measurement Example | 23 |
| Occupied Bandwidth..... | 24 |
| Measurement Procedure | 24 |
| Setting Limit | 24 |

| | |
|---------------------------------------|----|
| Measurement Example | 25 |
| Spectrum Emission Mask (SEM)..... | 25 |
| Measurement Procedure | 26 |
| Setting Limit | 26 |
| Measurement Example | 27 |
| ACLR | 28 |
| Measurement Procedure | 28 |
| Setting Limit | 28 |
| Measurement Example | 29 |
| Multi-ACLR | 30 |
| Measurement Procedure | 30 |
| Setting Limit | 31 |
| Measurement Example | 32 |
| Spurious Emissions | 32 |
| Measurement Procedure | 33 |
| Setting Limit | 34 |
| Measurement Example | 35 |
| Modulation Analysis Measurements..... | 36 |
| Setting Mode | 36 |
| Setting Frequency | 36 |
| Setting Amplitude | 38 |
| Setting Sweep Mode | 39 |
| Setting Trigger Source | 39 |
| Setting External Clock..... | 40 |
| Constellation | 41 |
| Measurement Procedure | 41 |
| Setting Limit | 42 |
| Measurement Example | 44 |
| Code Domain Power | 46 |
| Measurement Procedure | 46 |
| Setting Limit | 47 |
| Setting Display | 49 |
| Measurement Example | 49 |
| Codogram | 55 |
| Measurement Procedure | 55 |
| Setting Display | 57 |
| Measurement Example | 57 |
| RCSI | 58 |
| Measurement Procedure | 58 |
| Setting Display | 60 |
| Measurement Example | 61 |
| CDP Table..... | 62 |
| Measurement Procedure | 62 |
| Setting Display | 63 |
| Measurement Example | 63 |
| Auto Measurement | 64 |
| Setting Mode | 64 |
| Setting Frequency | 65 |
| Setting Trigger Source | 66 |
| Setting External Clock..... | 66 |
| Setting Limit | 68 |
| Measurement Procedure | 70 |
| Setting Display | 72 |

| | |
|-----------------------------------|----|
| Power Statistics CCDF | 72 |
| Setting Mode | 72 |
| Setting Frequency | 73 |
| Setting Amplitude | 74 |
| Setting Sweep Mode | 75 |
| Setting Trigger Source | 75 |
| Setting External Clock | 75 |
| Measurement Procedure | 77 |
| Measurement Example | 77 |
| WCDMA OTA Measurements | 78 |
| Setting Mode | 79 |
| Setting Frequency | 79 |
| Setting Amplitude | 80 |
| Setting Sweep Mode | 82 |
| Setting Trigger Source | 82 |
| Setting External Clock | 82 |
| WCDMA OTA Channel Scanner | 84 |
| Measurement Procedure | 84 |
| Setting Limit | 85 |
| Measurement Example | 86 |
| WCDMA OTA Scramble Scanner | 86 |
| Measurement Procedure | 86 |
| Measurement Example | 87 |
| WCDMA OTA Multipath Profile | 87 |
| Measurement Procedure | 88 |
| Measurement Example | 88 |
| WCDMA OTA Code Domain Power | 88 |
| Measurement Procedure | 89 |
| Setting Limit | 91 |
| Measurement Example | 94 |
| WCDMA Route Map | 94 |
| Measurement Procedure | 94 |
| Setting Limit | 96 |
| Measurement Example | 97 |
| Analysis | 98 |
| Using Marker | 98 |
| Using Peak Search | 99 |

(Rev. 6.0)

.....

USING WCDMA/HSDPA SIGNAL ANALYZER

This WCDMA/HSDPA Signal Analyzer can be used to test a WCDMA transmitter including HSDPA signals to check the base station's compliance with following standards documentation.

- n 3GPP TS 25.104 Base Station radio transmission and reception
- n 3GPP TS 25.141 Base Station (BS) conformance test
- n 3GPP TS 25.211 Physical channel and mapping of transport channels onto physical channels
- n 3GPP TS 25.212 Multiplexing and channel coding
- n 3GPP TS 25.213 Spreading and modulation

The instrument automatically makes standard defined measurements using the measurement methods and limits as defined in the standards. Detailed measurement results allow the user to analyze WCDMA and HSDPA system performance. The user may alter the measurement parameters for specialized analysis. Pass/Fail testing with standard defined or user defined upper and lower limits and the Pass/Fail indicator help the user to determine base station performance easily.

The JD740A series provides following analysis tools for WCDMA system.

- n Spectrum Analysis
 - Y Channel Power
 - Y Occupied Bandwidth
 - Y Spectrum Emission Mask
 - Y Adjacent Channel Leakage power Ratio (ACLR)
 - Y Multi-ACLR
 - Y Spurious Emissions
- n Modulation Analysis
 - Y Constellation
 - Y Code Domain Power
 - Y Codogram
 - Y Received Code Strength indicator (RCSI)

- Y CDP Table
- n Auto Measure
- n Power Statistics CCDF
- n Over The Air (OTA)
- Y Channel Scanner
- Y Scramble Scanner
- Y Multipath Profile
- Y Code Domain Power
- Y Route Map

DISPLAY OVERVIEW

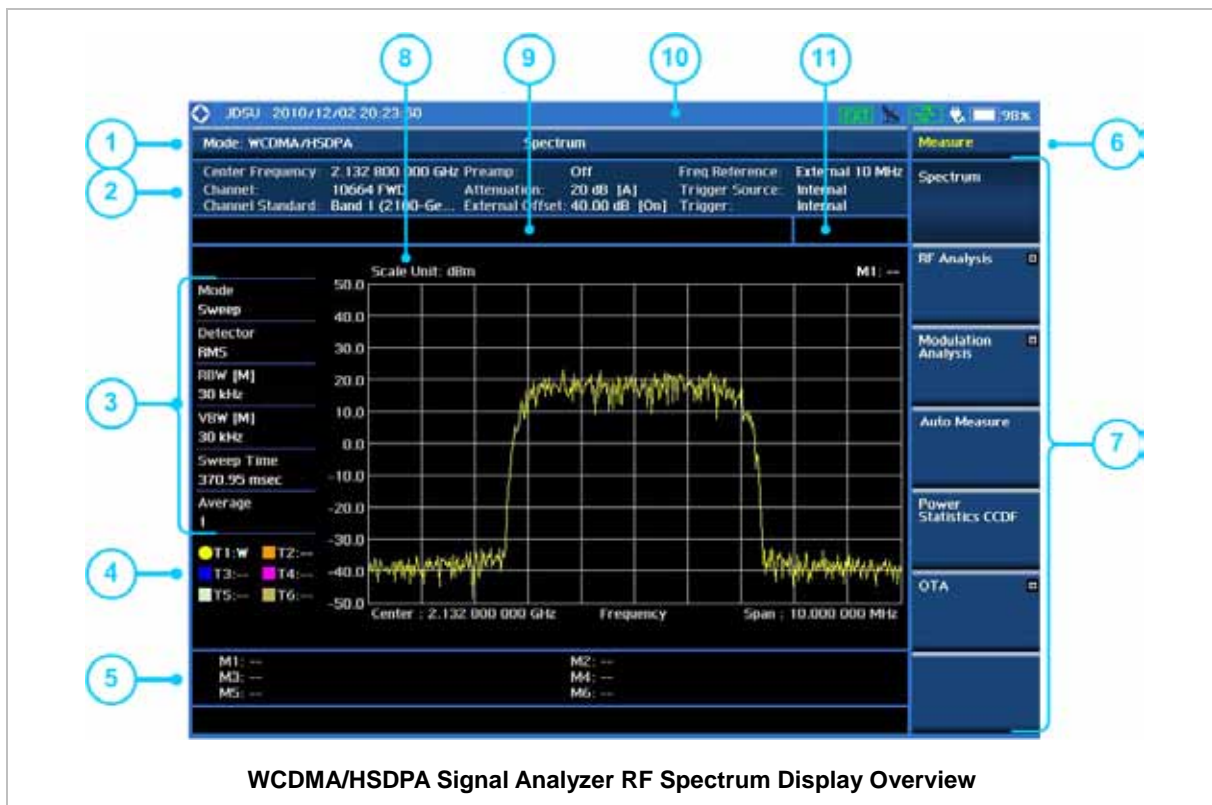

Measurement Mode Information: WCDMA/HSDPA Analyzer

Spectrum Input Level Setting Information: This window shows the most common settings or parameters of each measurement.

- Frequency and Channel Setting

- Amplitude Setting (Preamp, Attenuation, External Offset)
- Reference Setting (Frequency, Trigger)

Measurement Setting Information

- Spectrum Analyzer Operation Mode Information
- Detector Type Setting Information
- Spectrum Setting Information (RBW, VBW)
[A]: Auto mode, [M]: Manual mode
- Sweep Time Information: Displays current sweep time
- Average Number Information set through BW/AVG hard key. It shows the number of traces to be averaged.

Trace Information

- C: Captured
- M: Max Hold
- m: Min Hold
- W: Write Current Trace (Indicates current active trace)
- L: Loaded
- F: Trace View Off

Information on Marker Table displays up to 6 markers

Screen Menu Title

Screen Menu and Sub-menu

Scale Unit Information: dBm, dBV, dBmV, dBuV, V, and W

User Input Window: Activates when user input menu or key is selected. Pressing ESC hard key will cancel or deactivate user input window. Inactivate user input window before using hot keys.

NOTE: It is very important to inactivate the user input window when you intend to use the hot key menu on the numeric keys.

System Information

- Date and Time
- Positioning Information (Longitude and Latitude). It is available only when a GPS antenna is connected. Frequency reference is automatically set to GPS in the System menu when a GPS antenna is connected.
- Frequency Reference Indicator: INT for internal and EXT for external. The EXT icon is green when an external reference is locked or red when the external reference is not locked. When a GPS antenna is connected, this space will be blank.
- GPS Indicator: Color of the GPS icon changes among green, yellow and gray depending on locking status.
- USB Indicator
- DC Input Power Indicator
- Battery Indicator

Pass/Fail Indicator

CONNECTING A CABLE

Direct Connection

Connect the **Spectrum Analyzer RF In 50 Ω** port of the JD740A series and the PA output port of BTS.

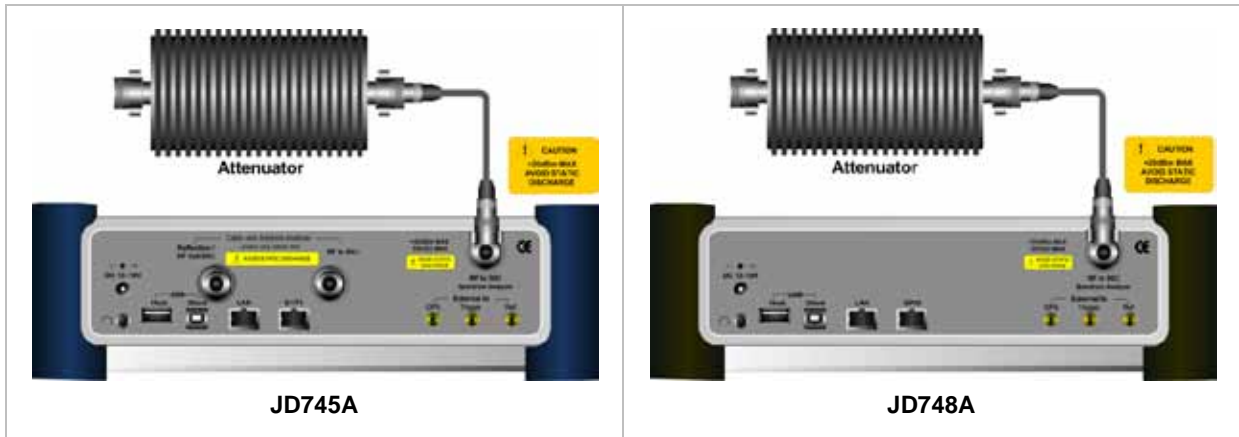

Indirect Connection

Connect the **Spectrum Analyzer RF In 50 Ω** port of the JD740A series and the monitor port of BTS.

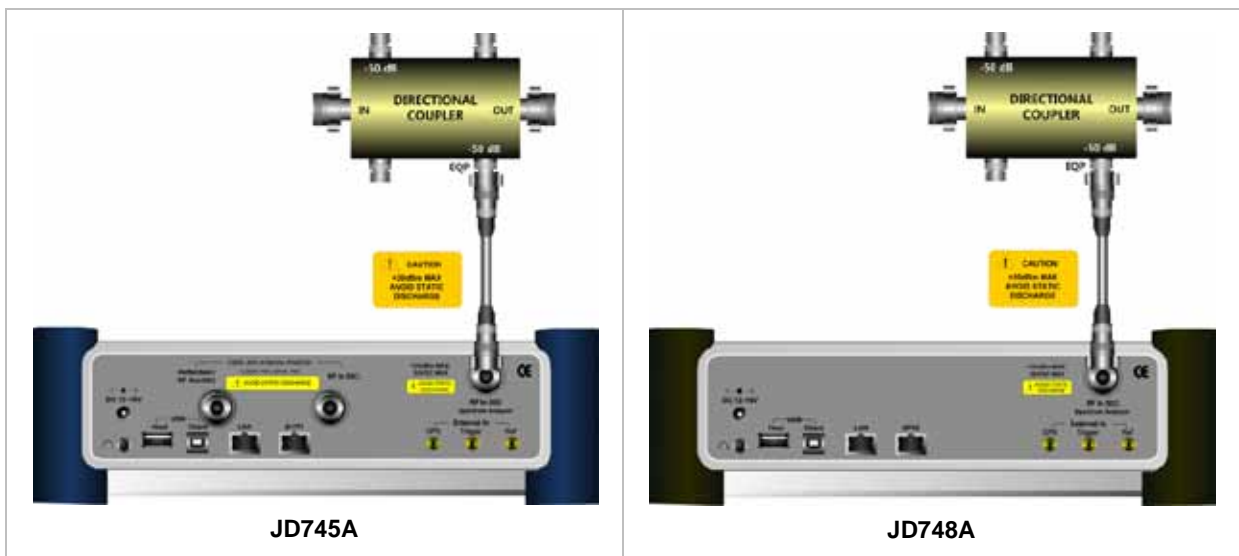

The maximum power for the **Spectrum Analyzer RF In 50 Ω** port is +20 dBm (0.1 Watt). If the input signal level to be measured is greater than +20 dBm, use a **High Power Attenuator** to prevent damage when you directly connect the signal to the instrument. Or connect a signal from the coupling port of a directional coupler.

Over The Air (OTA)

Connect an Omni/directional RF antenna to the **Spectrum Analyzer RF In 50 Ω** port of the JD740A series and then a GPS antenna to the **GPS** port of the JD740A series.

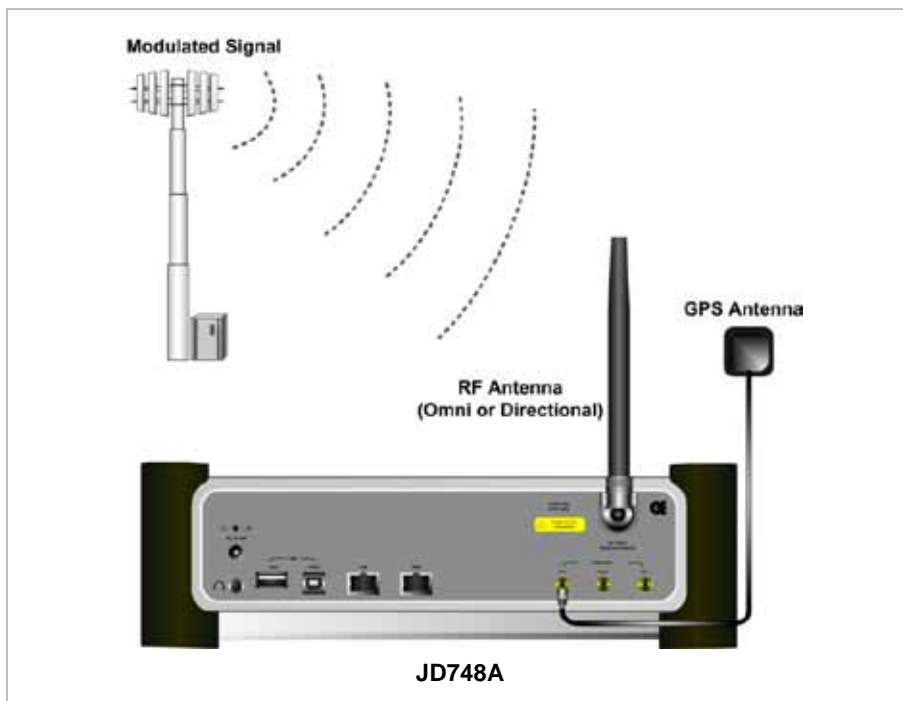
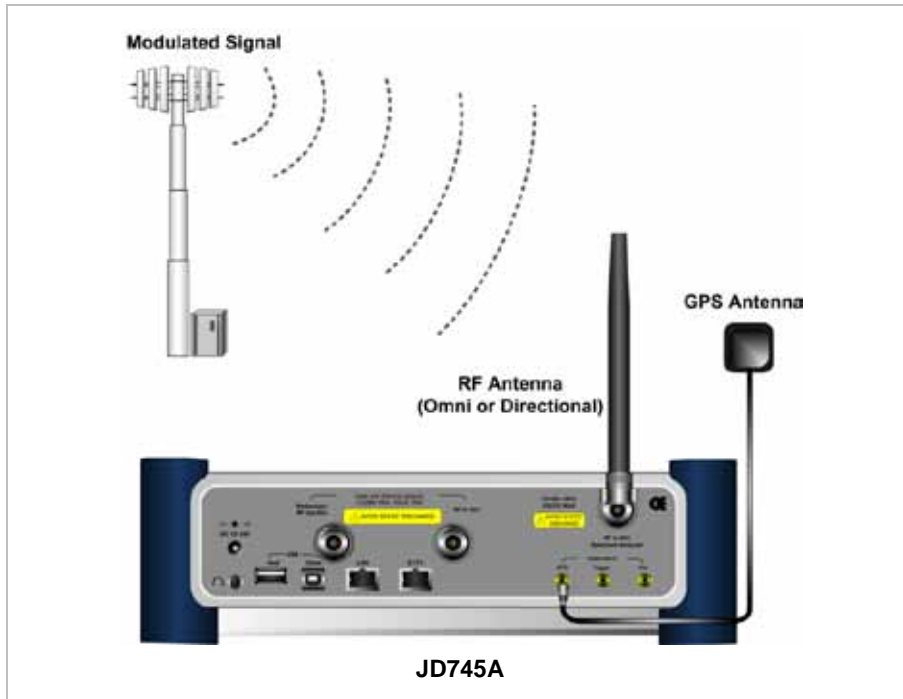

If the input signal level to be measured is less than 0 dBm, set 0 dB attenuation or turn on the preamp to have better dynamic range for the OTA testing.

SPECTRUM ANALYSIS MEASUREMENT

Setting Mode

| Step | Description |
|---|---|
| 1. Connect the cable | Connect a cable directly or indirectly as shown in the section Connecting a Cable on page 7 of this chapter. |
| 2. Select the mode MODE [Signal Analyzer] [WCDMA] [Spectrum] | Press the MODE hard key. Press the Signal Analyzer soft key. Press the WCDMA soft key. Press the Spectrum soft key. (Spectrum mode is set by default.) |

Setting Frequency

| Step | Description |
|--|---|
| 1. Set the frequency FREQ/DIST [Unit] <Freq> or <Channel> | Press the FREQ/DIST hard key. Press the Unit soft key. Toggle this key between Freq and Channel . A set of Freq/Dist screen menu changes accordingly. |
| <i>When Freq is selected:</i> [Center Frequency] Enter a value [GHz], [MHz], [kHz], or [Hz] | Press the Center Frequency soft key. Use the numeric keys, the rotary knob, or the arrow keys. When using the numeric keys, the input is completed by selecting one of the unit soft keys. |
| <i>When Channel is selected:</i> [Channel Standard] Select a channel standard | Press the Channel Standard soft key. If this channel standard shows its default setting Band Global, go set the channel number directly. Press the arrow keys, rotate the knob, or press the Page Up and Page Down soft keys to highlight a frequency band to select. |
| [Select] or ENTER | Press the Select soft key or the ENTER hard key. |
| [Channel Number] Enter a value | Press the Channel Number soft key. Use the numeric keys to input value and press the Forward |

| | |
|------------------|--|
| [Forward] | soft key to complete the input. The instrument automatically displays its corresponding center frequency value for the channel number. |
|------------------|--|

FREQ/DIST



- n **UNIT:** Determines the way how to set the frequency band either with standard band or custom frequency band. Toggling this key between **Freq** and **Channel** changes a set of Freq/Dist screen menu automatically. When the **Channel** is selected, the instrument sets the **Channel Standard** setting to **Band Global** as default so that the user can set the **Channel Number** directly without choosing a standard channel band from the list.
- n **CENTER FREQUENCY:** Changes the center frequency setting. Use the rotary knob or the arrow keys. Or use the numeric keys to input a certain value and press one of the unit soft keys to complete the input.
- n **FREQUENCY STEP:** Defines the amount of frequency to be increased or decreased when using the rotary knob or the arrow keys to change the **Center Frequency**. This frequency step size can be entered by using numeric keys and the unit soft keys.
- n **CHANNEL NUMBER:** Enters a channel number. The instrument automatically displays its corresponding center frequency value for the channel number.
- n **CHANNEL STEP:** Defines the amount of channel to be increased or decreased when using the rotary knob or the arrow keys to change the **Channel Number**. This channel step size can be entered by using numeric keys and the **Enter** soft key.
- n **CHANNEL STANDARD:** When the channel standard is selected from the list, the center frequency information on the display screen will be mapped accordingly to the selected channel standard. The channel standards available in the instrument are listed in the Appendix C – Band, Frequency & Channel Standard.

Setting Amplitude

| Step | Description |
|---|--|
| 1. Set the reference/attenuation level AMP/SCALE [Auto Scale] or [Reference Level] | Press the AMP/SCALE hard key. Press the Auto Scale soft key to automatically set optimum levels of reference and attenuation. Press the Reference Level soft key to set manually. |

| | |
|--|---|
| Enter a reference level value | Use the numeric keys or the rotary knob that changes in a 10 dB step. |
| [dBm] or ENTER | Press the dBm soft key or the ENTER hard key. |
| [Attenuation] | Press the Attenuation soft key. The Auto mode is set by default. This key toggles between the Auto and Manual . |
| <Auto> or <Manual> | Press the Attenuation soft key to highlight the Manual mode and change the attenuation value to optimize S/N. |
| Enter an attenuation value | Use the numeric keys or the rotary knob that changes in a 5 dB step. The attenuation setting range is 0 to 50 dB. |

AMP/SCALE



- n **AUTO SCALE:** The instrument can automatically set the scale to the minimum and maximum values on the Y-axis of the graph for optimum display of the traces measured. Each time the **Auto Scale** is selected, the top and bottom scales are set to the minimum and maximum values with margin on the Y-axis of the display screen.
- n **REFERENCE LEVEL:** Sets the maximum Y-axis range.
- n **SCALE/DIV:** Is used only for the Spectrum measurement screen. It represents the value of one division on the horizontal scale. The default value is 10 dB per division and the Y-Scale is set to 100 dB. Selecting the **Scale/Div** soft key enables to set the value to 1 dB per division with the numeric keys or the rotary knob.
- n **ATTENUATION**
 - Y **AUTO:** Input attenuator's value is automatically set depending on the reference level. This is the default operation mode, so it is recommended to use this mode unless a special measurement condition is needed.
 - Y **MANUAL:** Sets the attenuator's value for the **Spectrum Analyzer RF In 50 Ω** port.
- n **PREAMP:** Turns on or off the internal pre-amplifier. Preamp results in a correction being applied to compensate for the gain of the preamp so that amplitude readings show the value at the input connector. This soft key toggles between the **On** and **Off**. When it is set to On, the allowable attenuation input range is from 0 dB to 10 dB in a multiple of 5. If the attenuation value is manually set greater than 10 dB, the instrument will automatically turn off the pre-amplifier to display low level signal properly on the screen.
- n **UNITS:** Sets the scale unit on the display among **dBm**, **dBV**, **dBmV**, **dBuV**, **V**, and **W**.
- n **EXTERNAL OFFSET:** Sets an external offset value. An offset consists of a cable loss and a user offset and the measurement result shows the value reflecting both offset values. When the external offset value is set at 40 dB in the Spectrum mode, the measurement result compensates 40 dB at both the Spectrum Analyzer and Signal Analyzer modes.

Setting Averaging



- n **AVERAGE:** Sets the number of measurements to be averaged for the trace presentation. A maximum of 100 times of averaging can be set.

| Step | Description |
|---|---|
| 1. Set the averaging BW/AVG [Average] | Press the BW/AVG hard key. Press the Average soft key. |
| 2. Enter number of averaging to set | Use the numeric keys and input a number between 1 and 100. When the averaging reaches to the number set here, a new measurement value replaces the earliest measurement value in sequence. |
| 3. [Enter] or ENTER | Press the Enter soft key or the ENTER hard key. |

Setting Sweep Mode



This hot key is used to set the sweep parameters. The user input window must be inactive first to get the Sweep hot key function other than the number input.

- n **SWEEP MODE:** Sets the sweep method. Toggle between **Continue** and **Single**.

| Step | Description |
|--|---|
| 1. Set the sweep mode SWEEP [Sweep Mode] | Press the SWEEP hot key. Press the Sweep Mode soft key. Toggle between Continue and Single . |

Setting Trigger Source



This hot key is used to select the trigger source among **Internal**, **External**, and **GPS**. The user input window must be inactive first to get the Trigger hot key function other than the number input.

Setting External Clock

To enhance the reliability of modulation analysis measurements the JD740A series must be synchronized with the Base Station. When an external clock is not supplied, the JD740A series works with a built-in internal high-accuracy time base. In this case, some measurement results may exhibit inaccurate values. Therefore, it is highly recommended to use the same reference clock as signal source. Trigger mode can be changed by using the **TRIGGER** hot key.

EXTERNAL CLOCK OPERATING STANDARDS

| Clock | Type | Reference | Port | Switching Standard |
|--------------------|----------|--------------------|---------------|--|
| External Reference | Internal | Internal 10 MHz | | Default |
| | External | External Ref Clock | Ext Ref (SMA) | Manual switching (Input signal level >-3 dBm) |
| | GPS | GPS Clock | GPS (SMA) | Automatic switching (GPS signal received) |
| Trigger | Internal | Internal Trigger | | Default |
| | External | External Trigger | Trigger (SMA) | Manual switching |
| | GPS | GPS | GPS (SMA) | Manual switching |

CONNECTION

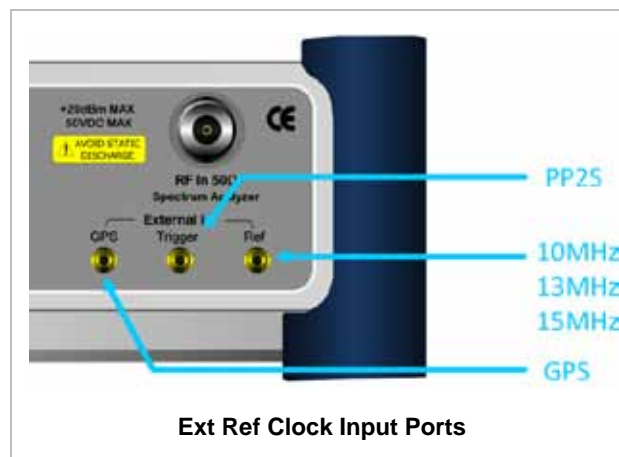



ENABLING EXTERNAL REFERENCE

| Step | Description |
|----------------------------------|---|
| 1. Connect an external reference | Connect one of the external references or a GPS antenna to the JD740A series. |

| | |
|---|---|
| <p>2. Change reference clock SYSTEM [Frequency Reference] [External 10 MHz], [External 13 MHz], [External 15 MHz] or [GPS]</p> | <p>Press the SYSTEM hot key. Press the Frequency Reference soft key to select one of the external reference clocks or GPS. Press one of the soft keys to choose among External 10 MHz, External 13 MHz, External 15 MHz, and GPS.</p> |
|---|---|

EXTERNAL REFERENCE INDICATOR INFORMATION

Each indicator tells different locking status according to a connection. When a GPS antenna is connected, longitude and latitude information will be displayed on the screen.

| Type | Indicator | Description |
|----------|--|----------------------------------|
| Internal |  (Green) | Locked |
| External |  (Green) | Locked |
| |  (Red) | Unlocked |
| GPS |  (Green) | Locked |
| |  (Yellow) | Locking in progress |
| |  (Gray) | Unable to lock or antenna failed |

Setting Trace and Display

TRACE/DISPLAY

- n **SELECT TRACE:** Selects an active trace from T1 to T6. Trace numbers are assigned to each captured trace or loaded trace. Pressing one of the 6 trace number soft keys sets the selected trace number as the active trace on the display screen.
- n **CLEAR WRITE:** Clears the selected trace and writes or assigns the current trace.
- n **MAX HOLD:** Sets the active trace to display the maximum response of the input signal. Active trace compares newly acquired data with the trace shown on the screen and displays the bigger trace on the display screen.
- n **MIN HOLD:** Sets the active trace to display the minimum response of the input signal. Active trace compares newly acquired data with the trace shown on the screen and displays the smaller trace on the display screen.
- n **CAPTURE:** Captures a current trace on the display screen with the selected trace number.
- n **TRACE VIEW:** Displays the trace of the selected trace number on the display screen or hides it

from the display screen. Press the **Select Trace** soft key to select a trace number and then press the **Trace View** soft key to toggle between the **Off** to hide and **On** to restore a hidden trace.

- n **TRACE CLEAR ALL:** Deletes all traces from the instrument and initializes the trace settings.

Measurement Procedure

| Step | Description |
|--|--|
| 1. Select the measurement mode MEASURE [Spectrum] | Press the MEASURE hot key. Press the Spectrum soft key. |

WCDMA Spectrum Measurement Procedure

Measurement Example



WCDMA Spectrum Analysis Measurement Screen

RF ANALYSIS MEASUREMENTS

RF Analysis in WCDMA/HSDPA Signal Analyzer provides single-button measurements for the following measurements.

- n Channel Power
- n Occupied Bandwidth
- n Spectrum Emission Mask
- n Adjacent Channel Leakage power Ratio (ACLR)
- n Multi-ACLR
- n Spurious Emissions

Setting Mode

| Step | Description |
|--|---|
| 1. Connect the cable | Connect a cable directly or indirectly as shown in the section Connecting a Cable on page 7 of this chapter. |
| 2. Select the mode MODE [Signal Analyzer] [WCDMA] [RF Analysis] [Channel Power], [Occupied BW], [Spectrum Emission Mask], [ACLR], [Multi-ACLR], or [Spurious Emissions] | Press the MODE hard key. Press the Signal Analyzer soft key. Press the WCDMA soft key. Press the RF Analysis soft key. Press one of the measurement mode soft keys to select. |

Setting Frequency

This setting is not used in the Multi-ACLR mode and the Spurious Emissions mode.

| Step | Description |
|---|--|
| 1. Set the frequency FREQ/DIST [Unit] <Freq> or <Channel> | Press the FREQ/DIST hard key. Press the Unit soft key. Toggle this key between Freq and Channel . A set of Freq/Dist screen menu changes accordingly. |
| <u>When Freq is selected:</u> [Center Frequency] | Press the Center Frequency soft key. |

| | |
|---|--|
| Enter a value [GHz], [MHz], [kHz], or [Hz] | Use the numeric keys, the rotary knob, or the arrow keys. When using the numeric keys, the input is completed by selecting one of the unit soft keys. |
| <u>When Channel is selected:</u> [Channel Standard] | Press the Channel Standard soft key. If this channel standard shows its default setting Band Global, go set the channel number directly. |
| Select a channel standard | Press the arrow keys, rotate the knob, or press the Page Up and Page Down soft keys to highlight a frequency band to select. |
| [Select] or ENTER | Press the Select soft key or the ENTER hard key. |
| [Channel Number] Enter a value [Forward] | Press the Channel Number soft key. Use the numeric keys to input value and press the Forward soft key to complete the input. The instrument automatically displays its corresponding center frequency value for the channel number. |

FREQ/DIST



- n **UNIT:** Determines the way how to set the frequency band either with standard band or custom frequency band. Toggling this key between **Freq** and **Channel** changes a set of Freq/Dist screen menu automatically. When the **Channel** is selected, the instrument sets the **Channel Standard** setting to **Band Global** as default so that the user can set the **Channel Number** directly without choosing a standard channel band from the list.
- n **CENTER FREQUENCY:** Changes the center frequency setting. Use the rotary knob or the arrow keys. Or use the numeric keys to input a certain value and press one of the unit soft keys to complete the input.
- n **FREQUENCY STEP:** Defines the amount of frequency to be increased or decreased when using the rotary knob or the arrow keys to change the **Center Frequency**. This frequency step size can be entered by using numeric keys and the unit soft keys.
- n **CHANNEL NUMBER:** Enters a channel number. The instrument automatically displays its corresponding center frequency value for the channel number.
- n **CHANNEL STEP:** Defines the amount of channel to be increased or decreased when using the rotary knob or the arrow keys to change the **Channel Number**. This channel step size can be entered by using numeric keys and the **Enter** soft key.
- n **CHANNEL STANDARD:** When the channel standard is selected from the list, the center frequency information on the display screen will be mapped accordingly to the selected channel

standard. The channel standards available in the instrument are listed in the Appendix C – Band, Frequency & Channel Standard.

Setting Amplitude

| Step | Description |
|--|---|
| 1. Set the reference/attenuation level | |
| AMP/SCALE | Press the AMP/SCALE hard key. |
| [Auto Scale] | Press the Auto Scale soft key to automatically set optimum levels of reference and attenuation. |
| or | |
| [Reference Level] | Press the Reference Level soft key to set manually. |
| Enter a reference level value | Use the numeric keys or the rotary knob that changes in a 10 dB step. |
| [dBm] or ENTER | Press the dBm soft key or the ENTER hard key. |
| [Attenuation] | Press the Attenuation soft key. The Auto mode is set by default. This key toggles between the Auto and Manual . |
| <Manual> | Press the Attenuation soft key to highlight the Manual mode and change the attenuation value to optimize S/N. |
| Enter an attenuation value | Use the numeric keys or the rotary knob that changes in a 5 dB step. The attenuation setting range is 0 to 50 dB. |

AMP/SCALE



- n **AUTO SCALE:** The instrument can automatically set the scale to the minimum and maximum values on the Y-axis of the graph for optimum display of the traces measured. Each time the **Auto Scale** is selected, the top and bottom scales are set to the minimum and maximum values with margin on the Y-axis of the display screen.
- n **REFERENCE LEVEL:** Sets the maximum Y-axis range.
- n **SCALE/DIV:** Is used only for the Spectrum measurement screen. It represents the value of one division on the horizontal scale. The default value is 10 dB per division and the Y-Scale is set to 100 dB. Selecting the **Scale/Div** soft key enables to set the value to 1 dB per division with the numeric keys or the rotary knob.
- n **ATTENUATION**
 - Y **AUTO:** Input attenuator's value is automatically set depending on the reference level. This is the default operation mode, so it is recommended to use this mode unless a special

measurement condition is needed.

- Y **MANUAL: MANUAL:** Sets the attenuator's value for the **Spectrum Analyzer RF In 50 Ω** port.
- n **PREAMP:** Turns on or off the internal pre-amplifier. Preamp results in a correction being applied to compensate for the gain of the preamp so that amplitude readings show the value at the input connector. This soft key toggles between the **On** and **Off**. When it is set to **On**, the allowable attenuation input range is from 0 dB to 10 dB in a multiple of 5. If the attenuation value is manually set greater than 10 dB, the instrument will automatically turn off the pre-amplifier to display low level signal properly on the screen.
- n **UNITS:** Sets the scale unit on the display among **dBm**, **dBV**, **dBmV**, **dBuV**, **V**, and **W**.
- n **EXTERNAL OFFSET:** Sets an external offset value. An offset consists of a cable loss and a user offset and the measurement result shows the value reflecting both offset values. When the external offset value is set at 40 dB in the Spectrum mode, the measurement result compensates 40 dB at both the Spectrum Analyzer and Signal Analyzer modes.

Setting Averaging



- n **AVERAGE:** Sets the number of measurements to be averaged for the trace presentation. A maximum of 100 times of averaging can be set. *This setting is not used in the Spurious Emissions mode.*

| Step | Description |
|---|--|
| 1. Set the averaging BW/AVG [Average] | Press the BW/AVG hard key. Press the Average soft key. |
| 2. Enter number of averaging to set | Use the numeric keys and input a number between 1 and 100. When the averaging reaches to the number set here, a new measurement value replaces the earliest measurement value in sequence. |
| 3. [Enter] or ENTER | Press the Enter soft key or the ENTER hard key. |

Setting Sweep Mode



This hot key is used to set the sweep parameters. The user input window must be inactive first to get the Sweep hot key function other than the number input.

n **SWEEP MODE:** Sets the sweep method. Toggle between **Continue** and **Single**.

| Step | Description |
|---|---|
| 1. Set the sweep mode SWEEP [Sweep Mode] | Press the SWEEP hot key. Press the Sweep Mode soft key. Toggle between Continue and Single . |

Setting Trigger Source



This hot key is used to select the trigger source among **Internal**, **External**, and **GPS**. The user input window must be inactive first to get the Trigger hot key function other than the number input.

Setting External Clock

To enhance the reliability of modulation analysis measurements the JD740A series must be synchronized with the Base Station. When an external clock is not supplied, the JD740A series works with a built-in internal high-accuracy time base. In this case, some measurement results may exhibit inaccurate values. Therefore, it is highly recommended to use the same reference clock as signal source. Trigger mode can be changed by using the **TRIGGER** hot key.

EXTERNAL CLOCK OPERATING STANDARDS

| Clock | Type | Reference | Port | Switching Standard |
|--------------------|----------|--------------------|---------------|--|
| External Reference | Internal | Internal 10 MHz | | Default |
| | External | External Ref Clock | Ext Ref (SMA) | Manual switching (Input signal level >-3 dBm) |
| | GPS | GPS Clock | GPS (SMA) | Automatic switching (GPS signal received) |
| Trigger | Internal | Internal Trigger | | Default |
| | External | External Trigger | Trigger (SMA) | Manual switching |
| | GPS | GPS | GPS (SMA) | Manual switching |

CONNECTION

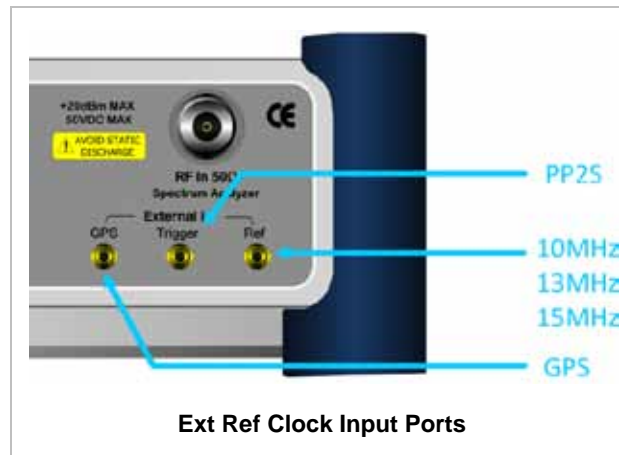

ENABLING EXTERNAL REFERENCE

| Step | Description |
|---|--|
| 1. Connect an external reference | Connect one of the external references or a GPS antenna to the JD740A series. |
| 2. Change reference clock SYSTEM [Frequency Reference] [External 10 MHz], [External 13 MHz], [External 15 MHz] or [GPS] | Press the SYSTEM hot key. Press the Frequency Reference soft key to select one of the external reference clocks or GPS. Press one of the soft keys to choose among External 10 MHz , External 13 MHz , External 15 MHz , and GPS . |

EXTERNAL REFERENCE INDICATOR INFORMATION

Each indicator tells different locking status according to a connection. When a GPS antenna is connected, longitude and latitude information will be displayed on the screen.

| Type | Indicator | Description |
|----------|--|----------------------------------|
| Internal |  (Green) | Locked |
| External |  (Green) | Locked |
| |  (Red) | Unlocked |
| GPS |  (Green) | Locked |
| |  (Yellow) | Locking in progress |
| |  (Gray) | Unable to lock or antenna failed |

CHANNEL POWER

The Channel Power measurement is a common test used in the wireless industry to measure the total transmitted power of a radio within a defined frequency channel. This procedure measures the total power within the defined channel for WCDMA. This measurement is applied to design, characterize, evaluate, and verify transmitters and their components or devices for base stations and mobile stations.

The channel power measurement identifies the channel power within a specified bandwidth (default is 5 MHz, as per the 3GPP WCDMA technical specifications) and the power spectral density (PSD) in dBm/Hz.

Measurement Procedure

| Step | Description |
|---|---|
| 1. Set the measurement mode MEASURE [RF Analysis] [Channel Power] | Press the MEASURE hot key. Press the RF Analysis soft key. Press the Channel Power soft key. |

WCDMA Channel Power Measurement Procedure

Setting Limit

LIMIT



This hot key is used to set the threshold value for the limit line on the display screen. It turns on or off the limit or band limit settings of the measurement for pass/fail indication. The user input window must be inactive first to get the Limit hot key function other than the number input.

| Step | Description |
|---|---|
| 1. Select the limit LIMIT [RF Test Limits] [Channel Power] [Test Limits] <On> or <Off> [High Limit] Enter a value | Press the LIMIT hot key. Press the RF Test Limits soft key. Press the Channel Power soft key. Press the Test Limits soft key to toggle between On and Off and select one. Press the High Limit soft key to set the upper limit of the Pass/Fail criteria. Use the numeric keys to input value. |

| | |
|---|---|
| <p>[dBm] or ENTER [Low Limit] Enter a value [dBm] or ENTER</p> | <p>Press the unit soft key or the ENTER hard key. Press the Low Limit soft key to set the lower limit of the Pass/Fail criteria. Use the numeric keys to input value. Press the unit soft key or the ENTER hard key.</p> |
| <p>2. Enable beep LIMIT [Beep] <On> or <Off></p> | <p>Press the LIMIT hot key. Press the Beep soft key to toggle between On and Off and select one. This will make audible alarm if the measurement result goes beyond the limit.</p> |

- n **TEST LIMITS:** Enables or disables Pass/Fail results on the display screen. Toggle the **Test Limits** soft key to set it to **On** or **Off**.
- n **HIGH LIMIT:** Sets the upper limit of the Pass/Fail criteria. Use the numeric keys to enter a threshold or limit value and press the **dBm** unit soft key or the **ENTER** hard key to complete the input.
- n **LOW LIMIT:** Sets the lower limit of the Pass/Fail criteria. Use the numeric keys to enter a threshold or limit value and press the **dBm** unit soft key or the **ENTER** hard key to complete the input.

Measurement Example

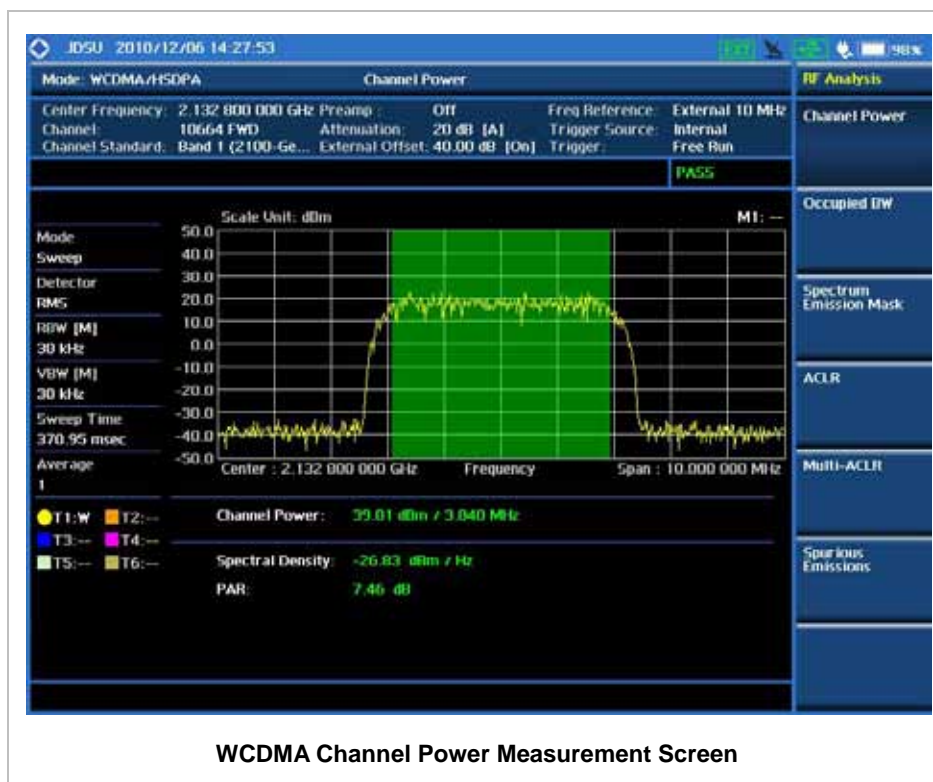

WCDMA Channel Power Measurement Screen

OCCUPIED BANDWIDTH

The 3GPP specifications require the occupied bandwidth (OBW) of a transmitted WCDMA signal to be less than 5 MHz, where occupied bandwidth is defined as the bandwidth containing 99% of the total channel power. In this measurement, the total power of the displayed span is measured. Then the power is measured inward from the right and left extremes until 0.5% of the power is accounted for each of the upper and lower part of the span and the calculated difference is the occupied bandwidth.

The spectrum shape of a WCDMA signal can give a useful qualitative insight into the transmitter's operation. Any distortion to the spectrum shape might be an indication of degradation of the transmitter's performance.

Measurement Procedure

| Step | Description |
|---|---|
| 1. Set the measurement mode MEASURE [RF Analysis] [Occupied BW] | Press the MEASURE hot key. Press the RF Analysis soft key. Press the Occupied BW soft key. |

WCDMA Occupied BW Measurement Procedure

Setting Limit



This hot key is used to set the threshold value for the limit line on the display screen. It turns on or off the limit or band limit settings of the measurement for pass/fail indication. The user input window must be inactive first to get the Limit hot key function other than the number input.

| Step | Description |
|---|--|
| 1. Select the limit LIMIT [RF Test Limits] [Occupied BW] [Test Limit] <On> or <Off> [High Limit] Enter a value | Press the LIMIT hot key. Press the RF Test Limits soft key. Press the Occupied BW soft key. Press the Test Limit soft key to toggle between On and Off and select one. Press the High Limit soft key to set the upper limit of the Pass/Fail criteria. Use the numeric keys to input value. |

| | |
|---|--|
| [MHz], [kHz], or [Hz] | Press the unit soft key to select. |
| 2. Enable beep LIMIT [Beep] <On> or <Off> | Press the LIMIT hot key. Press the Beep soft key to toggle between On and Off and select one. This will make audible alarm if the measurement result goes beyond the limit. |

- n **TEST LIMIT:** Enables or disables Pass/Fail results on the display screen. Toggle the **Test Limit** soft key to set it to **On** or **Off**.
- n **HIGH LIMIT:** Sets the upper limit of the Pass/Fail criteria. Use the numeric keys to enter a threshold or limit value and press one of the unit soft keys to complete the input.

Measurement Example

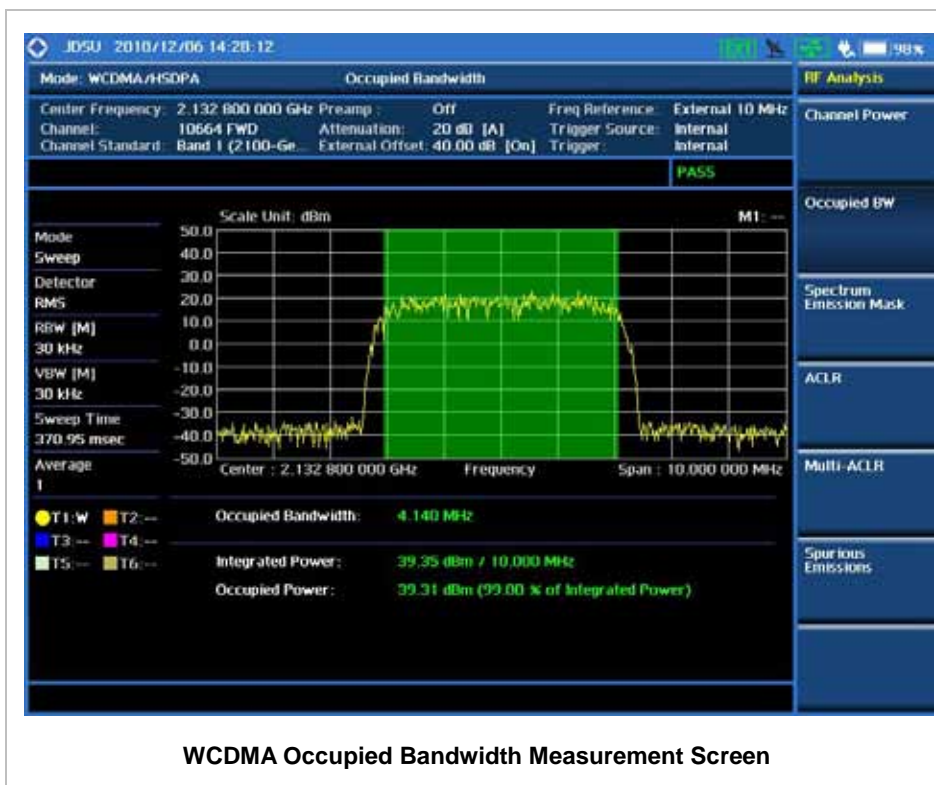

SPECTRUM EMISSION MASK (SEM)

The Spectrum Emission Mask (SEM) measurement required by 3GPP2 specifications encompasses different power limits and different measurement bandwidths (resolution bandwidths) at various

frequency offsets. It may be expressed as a ratio of power spectral densities between the carrier and the specified offset frequency band. It provides useful figures-of-merit for the spectral re-growth and emissions produced by components and circuit blocks, without the rigor of performing a full SEM measurement.

The SEM measures spurious signal levels in up to five pairs of offset or region frequencies and relates them to the carrier power.

Measurement Procedure

| Step | Description |
|---|--|
| 1. Set the measurement mode MEASURE [RF Analysis] [Spectrum Emission Mask] | Press the MEASURE hot key. Press the RF Analysis soft key. Press the Spectrum Emission Mask soft key. |
| 2. Set the measurement parameter MEASURE SETUP [Mask Type] [~ 31 dBm], [31 ~ 39 dBm], [39 ~ 43 dBm], or [49 dBm ~] | Press the MEASURE SETUP hot key. Press the Mask Type soft key. Press one of the soft keys to select. |

WCDMA Spectrum Emission Mask Measurement Procedure

MEASURE SETUP



- n **MASK TYPE:** Sets the mask type according to the output power of the base station to be tested. Select among ~ 31 dBm, 31 ~ 39 dBm, 39 ~ 43 dBm, and 49 dBm ~.

Setting Limit

LIMIT



This hot key is used to set the threshold value for the limit line on the display screen. It turns on or off the limit or band limit settings of the measurement for pass/fail indication. The user input window must be inactive first to get the Limit hot key function other than the number input.

| Step | Description |
|--|---------------------------------|
| 1. Select the limit mode LIMIT | Press the LIMIT hot key. |

| | |
|---|--|
| <p>[RF Test Limits] [Spectrum Emission Mask] [Test Limit] <On> or <Off></p> | <p>Press the RF Test Limits soft key. Press the Spectrum Emission Mask soft key. Press the Test Limit soft key to toggle between On and Off and select one.</p> |
| <p>2. Enable beep LIMIT [Beep] <On> or <Off></p> | <p>Press the LIMIT hot key. Press the Beep soft key to toggle between On and Off and select one. This will make audible alarm if the measurement result goes beyond the limit.</p> |

- n **TEST LIMIT:** Enables or disables Pass/Fail results on the display screen. Toggle the **Test Limit** soft key to set it to **On** or **Off**.

Measurement Example

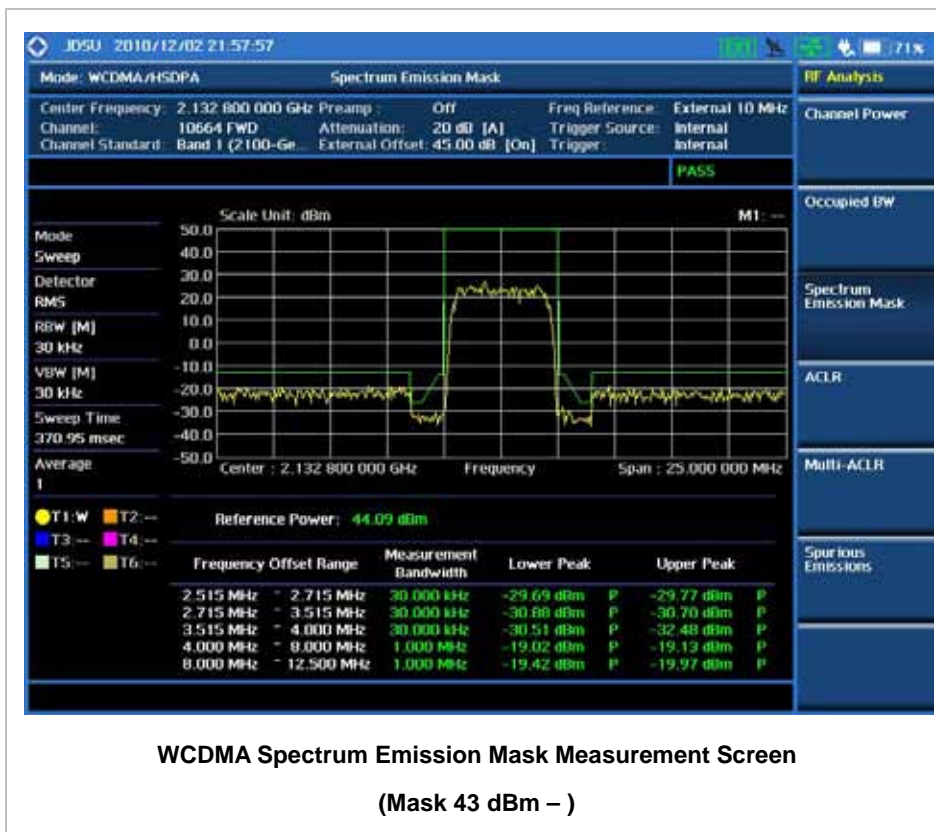

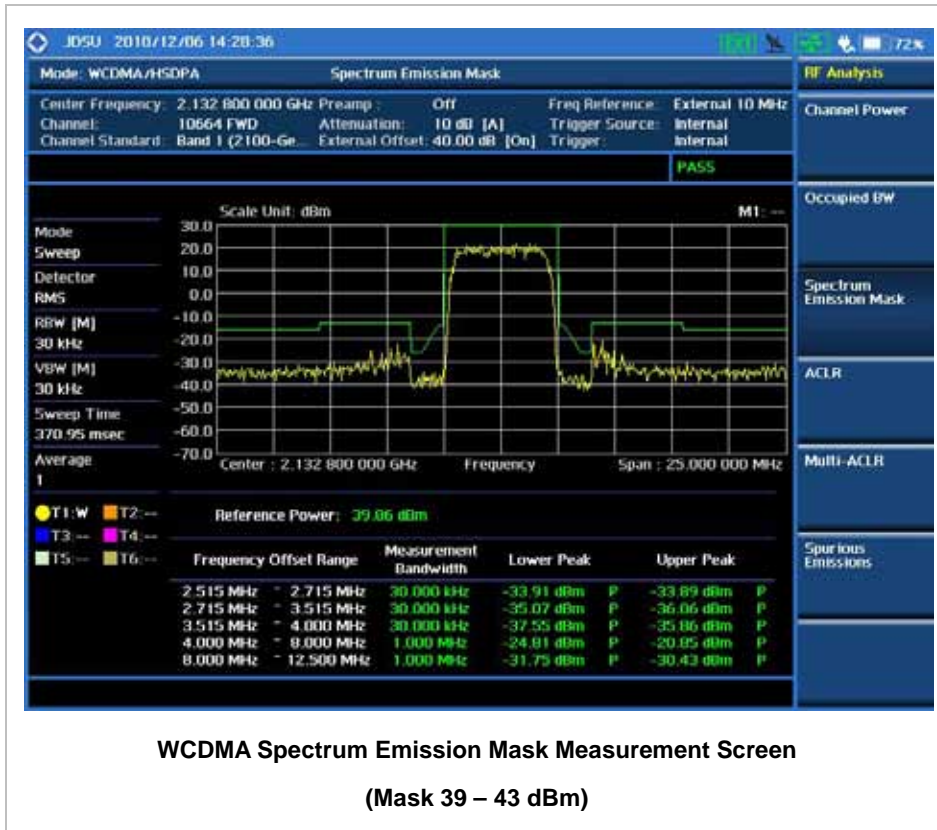

ACLR

The Adjacent Channel Power Ratio (ACPR), designated by the 3GPP WCDMA specifications as the Adjacent Channel Leakage power Ratio (ACLR), is the power contained in a specified frequency channel bandwidth relative to the total carrier power. It may also be expressed as a ratio of power spectral densities between the carrier and the specified offset frequency band.

Measurement Procedure

| Step | Description |
|--|--|
| 1. Set the measurement mode MEASURE [RF Analysis] [ACLR] | Press the MEASURE hot key. Press the RF Analysis soft key. Press the ACLR soft key. |

WCDMA ACLR Measurement Procedure

Setting Limit

LIMIT

This hot key is used to set the threshold value for the limit line on the display screen. It turns on or off the limit or band limit settings of the measurement for pass/fail indication. The user input window must be inactive first to get the Limit hot key function other than the number input.

| Step | Description |
|--|--|
| 1. Select the limit LIMIT [RF Test Limits] [ACLR] [Test Limit] <On> or <Off> | Press the LIMIT hot key. Press the RF Test Limits soft key. Press the ACLR soft key. Press the Test Limit soft key to toggle between On and Off and select one. |
| 2. Enable beep LIMIT [Beep] <On> or <Off> | Press the LIMIT hot key. Press the Beep soft key to toggle between On and Off and select one. This will make audible alarm if the measurement result goes beyond the limit. |

- n **TEST LIMIT:** Enables or disables Pass/Fail results on the display screen. Toggle the **Test Limit** soft key to set it to **On** or **Off**.

Measurement Example



WCDMA ACLR Measurement Screen

MULTI-ACLR

The Multi-ACLR measurement is used to perform multi-channel ACLR measurements with as many channels as possible. It helps the user to measure ACLR in multi-channel transmitting Base Station environment.

Measurement Procedure

| Step | Description |
|---|---|
| 1. Set the measurement mode MEASURE [RF Analysis] [Multi-ACLR] | Press the MEASURE hot key. Press the RF Analysis soft key. Press the Multi-ACLR soft key. |
| 2. Set the measurement parameters MEASURE SETUP [Unit] <Freq> or <Channel> <u>When Freq is selected:</u> [Lowest Frequency] Enter a value [GHz], [MHz], [kHz], or [Hz] [Highest Frequency] Enter a value [GHz], [MHz], [kHz], or [Hz] <u>When Channel is selected:</u> [Channel Standard] Select a channel standard [Select] or ENTER [Lowest Channel] Enter a value [Forward] [Highest Channel] Enter a value | Press the MEASURE SETUP hot key. Press the Unit soft key. Toggle this key between Freq and Channel . A set of Freq/Dist screen menu changes accordingly. Press the Lowest Frequency soft key. Use the numeric keys to input value. Press one of the unit soft keys to select. Press the Highest Frequency soft key. Use the numeric keys to input value. Press one of the unit soft keys to select. Press the Channel Standard soft key. If this channel standard shows its default setting Band Global, go set the channel number directly Press the arrow keys, rotate the knob, or press the Page Up and Page Down soft keys to highlight a frequency band to select. Press the Select soft key or the ENTER hard key. Press the Lowest Channel soft key. Use the numeric keys to input value. Press the Forward soft key. Press the Highest Channel soft key. Use the numeric keys to input value. |

[Forward]

Press the **Forward** soft key.

WCDMA Multi-ACLR Measurement Procedure

MEASURE SETUP



- n **UNIT:** Determines the way how to set the frequency band either with standard band or custom frequency band. Toggling this key between **Freq** and **Channel** changes a set of Freq/Dist screen menu automatically.
- n **LOWEST FREQUENCY:** Sets the center frequency of the far left end on the display. Use the numeric keys to enter a value and press one of the unit soft keys to complete the input.
- n **HIGHEST FREQUENCY:** Sets the center frequency of the far right end on the display. Use the numeric keys to enter a value and press one of the unit soft keys to complete the input.
- n **LOWEST CHANNEL:** Sets the channel number of the far left end on the display.
- n **HIGHEST CHANNEL:** Sets the channel number of the far right end on the display.
- n **CHANNEL STANDARD:** When the channel standard is selected from the list, the center frequency information on the display screen will be mapped accordingly to the selected channel standard. The channel standards available in the instrument are listed in the Appendix C – Band, Frequency & Channel Standard.

Setting Limit

LIMIT



This hot key is used to set the threshold value for the limit line on the display screen. It turns on or off the limit or band limit settings of the measurement for pass/fail indication. The user input window must be inactive first to get the Limit hot key function other than the number input.

| Step | Description |
|--|--|
| 1. Select the limit LIMIT [RF Test Limits] [Multi-ACLR] [Test Limit] <On> or <Off> | Press the LIMIT hot key. Press the RF Test Limits soft key. Press the Multi-ACLR soft key. Press the Test Limit soft key to toggle between On and Off and select one. |

| | |
|--|--|
| <p>2. Enable beep LIMIT [Beep] <On> or <Off></p> | <p>Press the LIMIT hot key. Press the Beep soft key to toggle between On and Off and select one. This will make audible alarm if the measurement result goes beyond the limit.</p> |
|--|--|

- n **TEST LIMIT:** Enables or disables Pass/Fail results on the display screen. Toggle the **Test Limit** soft key to set it to **On** or **Off**.

Measurement Example

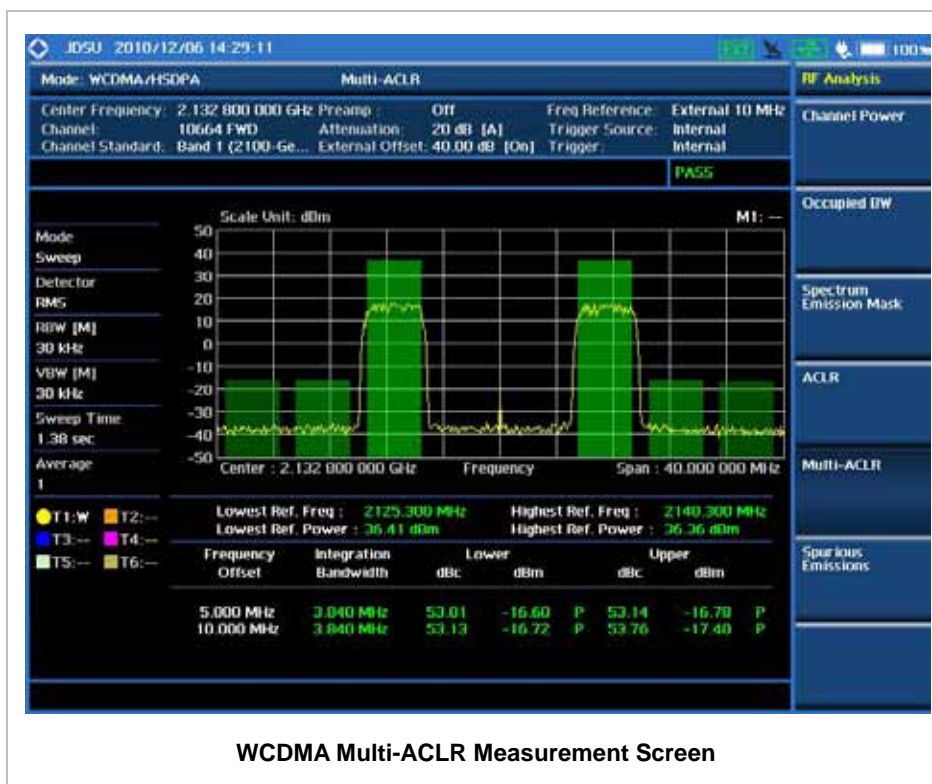

WCDMA Multi-ACLR Measurement Screen

SPURIOUS EMISSIONS

Out-of-band emissions are unwanted emissions immediately outside the channel bandwidth resulting from the modulation process and non-linearity in the transmitter but excluding spurious emissions. The Spurious Emissions measurement is to identify and determine the power level of out-of-band spurious emission within the necessary channel bandwidth and modulated signal measured at the RF port of the Base Station.

Measurement Procedure

| Step | Description |
|--|---|
| 1. Set the measurement mode MEASURE [RF Analysis] [Spurious Emissions] | Press the MEASURE hot key. Press the RF Analysis soft key. Press the Spurious Emissions soft key. |
| 2. Set the measurement parameters MEASURE SETUP [Range Table] [Range] Enter a value [Enter] [Start Frequency] Enter a value [GHz], [MHz], [kHz], or [Hz] [Stop Frequency] Enter a value [GHz], [MHz], [kHz], or [Hz] [Start Limit] Enter a value [dBm] [Stop Limit] Enter a value [dBm] [Attenuation] Enter a value [dB] or ENTER [RBW] Enter a value [GHz], [MHz], [kHz], or [Hz] [VBW] Enter a value [GHz], [MHz], [kHz], or [Hz] [Measure Type] <Examine> or <Full> [Average] Enter a value [Enter] or ENTER | Press the MEASURE SETUP hot key. Press the Range Table soft key. Press the Range soft key. Use the numeric keys to select the range number. Press the Enter soft key. Press the Start Frequency soft key. Use the numeric keys. Press one of the unit soft keys to select. Press the Stop Frequency soft key. Use the numeric keys. Press one of the unit soft keys to select. Press the Start Limit soft key. Use the numeric keys. Press the unit soft key to complete the input. Press the Stop Limit soft key. Use the numeric keys. Press the unit soft key to complete the input. Press the Attenuation soft key. Use the numeric keys to enter input value in the multiple of 5. Press the dB unit soft key or the ENTER hard key. Press the RBW soft key. Use the numeric keys. Press one of the unit soft keys to select. Press the VBW soft key. Use the numeric keys. Press one of the unit soft keys to select. Press the Measure Type soft key to toggle between Examine and Full . Press the Average soft key. Use the numeric keys to enter a value. Press the Enter soft key or the ENTER hard key. |

WCDMA Spurious Emissions Measurement Procedure

MEASURE SETUP



Sets the measurement parameters including range table and measurement type. The measurement settings can be saved and recalled as a file. Also, JDViewer, PC application software allows the user to set the parameters in the user's computer to import into the instrument.

- n **RANGE TABLE:** Sets the range table parameters.
 - Y **RANGE:** Adds a new range number or selects one of the existing range numbers to show or hide the particular frequency range in the range table at the bottom of the screen. Use the numeric keys to enter a range number and press the **Enter** soft key to complete the input. Each time the **Range** soft key is press, it toggles between **On** and **Off**.
 - Y **START FREQUENCY:** Sets or changes the start frequency value to be measured for the selected range number in the Range menu. Use the numeric keys to enter a value and press one of the unit soft keys.
 - Y **STOP FREQUENCY:** Sets or changes the stop frequency value to be measured for the selected range number in the Range menu. Use the numeric keys to enter a value and press one of the unit soft keys.
 - Y **START LIMIT:** Sets the start value of the limit line for the displayed range.
 - Y **STOP LIMIT:** Sets the stop value of the limit line for the displayed range.
 - Y **ATTENUATION:** Sets the attenuation value in the multiple of 5.
 - Y **RBW:** Sets the resolution bandwidth for the selected range number in the Range menu.
 - Y **VBW:** Sets the video bandwidth for the selected range number in the Range menu.
- n **MEASURE TYPE:** Sets the measurement type to **Examine** or **Full**. Toggle between **Examine** and **Full**. Examine mode will show selected range only. The instrument will automatically switch and show all ranges when Full is selected.
- n **RANGE:** Selects the range number to be displayed on the screen. This key is activated only when the **Measure Type** is set to **Examine** mode. Use the numeric keys to select one of the existing range numbers that are configured in the Range Table menu. Pressing the **Enter** soft key completes the input and changes the display.
- n **AVERAGE:** Sets the frequency the number of trace to be averaged.

Setting Limit

LIMIT



This hot key is used to set the threshold value for the limit line on the display screen. It turns on or off the limit or band limit settings of the measurement for pass/fail indication. The user input window must be inactive first to get the Limit hot key function other than the number input.

| Step | Description |
|--|--|
| 1. Select the limit LIMIT [RF Test Limits] [Spurious Emissions] [Test Limit] <On> or <Off> | Press the LIMIT hot key. Press the RF Test Limits soft key. Press the Spurious Emissions soft key. Press the Test Limit soft key to toggle between On and Off and select one. |
| 2. Enable beep LIMIT [Beep] <On> or <Off> | Press the LIMIT hot key. Press the Beep soft key to toggle between On and Off and select one. This will make audible alarm if the measurement result goes beyond the limit. |

- n **TEST LIMIT:** Enables or disables Pass/Fail results on the display screen. Toggle the **Test Limit** soft key to set it to **On** or **Off**.

Measurement Example

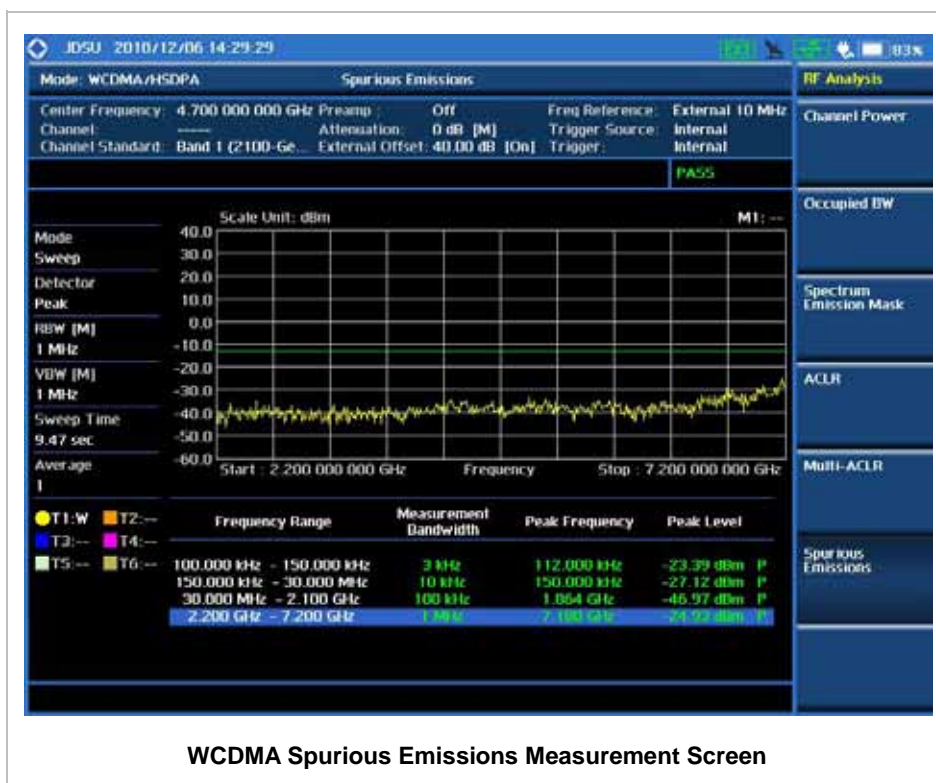

MODULATION ANALYSIS MEASUREMENTS

Modulation Analysis in WCDMA/HSDPA Signal Analyzer provides single-button measurements for the following essential measurements.

- n Constellation
- n Code Domain Power
- n Codogram
- n Received Code Strength indicator (RCSI)
- n CDP Table

Setting Mode

| Step | Description |
|--|---|
| 1. Connect the cable | Connect a cable directly or indirectly as shown in the section Connecting a Cable on page 7 of this chapter. |
| 2. Select the mode MODE [Signal Analyzer] [WCDMA] [Modulation Analysis] [Constellation], [Code Domain Power], [Codogram], [RCSI], or [CDP Table] | Press the MODE hard key. Press the Signal Analyzer soft key. Press the WCDMA soft key. Press the Modulation Analysis soft key. Press one of the measurement mode soft keys to select. |

Setting Frequency

| Step | Description |
|---|--|
| 1. Set the frequency FREQ/DIST [Unit] <Freq> or <Channel> | Press the FREQ/DIST hard key. Press the Unit soft key. Toggle this key between Freq and Channel . A set of Freq/Dist screen menu changes accordingly. |

| | |
|---|---|
| <p><u>When Freq is selected:</u></p> <p>[Center Frequency] Enter a value [GHz], [MHz], [kHz], or [Hz]</p> | <p>Press the Center Frequency soft key. Use the numeric keys, the rotary knob, or the arrow keys. When using the numeric keys, the input is completed by selecting one of the unit soft keys.</p> |
| <p><u>When Channel is selected:</u></p> <p>[Channel Standard]</p> <p>Select a channel standard</p> <p>[Select] or ENTER</p> <p>[Channel Number] Enter a value [Forward]</p> | <p>Press the Channel Standard soft key. If this channel standard shows its default setting Band Global, go set the channel number directly. Press the arrow keys, rotate the knob, or press the Page Up and Page Down soft keys to highlight a frequency band to select. Press the Select soft key or the ENTER hard key.</p> <p>Press the Channel Number soft key. Use the numeric keys to input value and press the Forward soft key to complete the input. The instrument automatically displays its corresponding center frequency value for the channel number.</p> |

FREQ/DIST



- n **UNIT:** Determines the way how to set the frequency band either with standard band or custom frequency band. Toggling this key between **Freq** and **Channel** changes a set of Freq/Dist screen menu automatically. When the **Channel** is selected, the instrument sets the **Channel Standard** setting to **Band Global** as default so that the user can set the **Channel Number** directly without choosing a standard channel band from the list.
- n **CENTER FREQUENCY:** Changes the center frequency setting. Use the rotary knob or the arrow keys. Or use the numeric keys to input a certain value and press one of the unit soft keys to complete the input.
- n **FREQUENCY STEP:** Defines the amount of frequency to be increased or decreased when using the rotary knob or the arrow keys to change the **Center Frequency**. This frequency step size can be entered by using numeric keys and the unit soft keys.
- n **CHANNEL NUMBER:** Enters a channel number. The instrument automatically displays its corresponding center frequency value for the channel number.
- n **CHANNEL STEP:** Defines the amount of channel to be increased or decreased when using the rotary knob or the arrow keys to change the **Channel Number**. This channel step size can be entered by using numeric keys and the **Enter** soft key.
- n **CHANNEL STANDARD:** When the channel standard is selected from the list, the center

frequency information on the display screen will be mapped accordingly to the selected channel standard. The channel standards available in the instrument are listed in the Appendix C – Band, Frequency & Channel Standard.

Setting Amplitude

| Step | Description |
|--|---|
| 1. Set the reference/attenuation level | |
| AMP/SCALE | Press the AMP/SCALE hard key. |
| [Auto Scale] | Press the Auto Scale soft key to automatically set optimum levels of reference and attenuation. |
| or | |
| [Reference Level] | Press the Reference Level soft key to set manually. |
| Enter a reference level value | Use the numeric keys or the rotary knob that changes in a 10 dB step. |
| [dBm] or ENTER | Press the dBm soft key or the ENTER hard key. |
| [Attenuation] | Press the Attenuation soft key. The Auto mode is set by default. This key toggles between the Auto and Manual . |
| <Manual> | Press the Attenuation soft key to highlight the Manual mode and change the attenuation value to optimize S/N. |
| Enter an attenuation value | Use the numeric keys or the rotary knob that changes in a 5 dB step. The attenuation setting range is 0 to 50 dB. |

AMP/SCALE



- n **AUTO SCALE:** The instrument can automatically set the scale to the minimum and maximum values on the Y-axis of the graph for optimum display of the traces measured. Each time the **Auto Scale** is selected, the top and bottom scales are set to the minimum and maximum values with margin on the Y-axis of the display screen.
- n **REFERENCE:** Sets the display of measurement result to relative or absolute value. Toggle between **Abs** for absolute and **Rel** for relative. *This key is not used in the Constellation mode and the CDP Table mode.*
 - Y **ABS:** The code domain power is measured absolute to channel power.
 - Y **REL:** The code domain power is measured relative to channel power.
- n **REFERENCE LEVEL:** Sets the maximum Y-axis range. This key is activated only when the **Reference** is set to the **Abs** mode. *This key is not used in the Constellation mode and the CDP*

Table mode.

n **ATTENUATION**

Y **AUTO:** Input attenuator's value is automatically set depending on the reference level. This is the default operation mode, so it is recommended to use this mode unless a special measurement condition is needed.

Y **MANUAL:** Sets the attenuator's value for the **Spectrum Analyzer RF In 50 Ω** port.

n **PREAMP:** Turns on or off the internal pre-amplifier. Preamp results in a correction being applied to compensate for the gain of the preamp so that amplitude readings show the value at the input connector. This soft key toggles between the **On** and **Off**. When it is set to On, the allowable attenuation input range is from 0 dB to 10 dB in a multiple of 5. If the attenuation value is manually set greater than 10 dB, the instrument will automatically turn off the pre-amplifier to display low level signal properly on the screen.

n **EXTERNAL OFFSET:** Sets an external offset value. An offset consists of a cable loss and a user offset and the measurement result shows the value reflecting both offset values. When the external offset value is set at 40 dB in the Spectrum mode, the measurement result compensates 40 dB at both the Spectrum Analyzer and Signal Analyzer modes.

Setting Sweep Mode

SWEEP



This hot key is used to set the sweep parameters. The user input window must be inactive first to get the Sweep hot key function other than the number input.

n **SWEEP MODE:** Sets the sweep method. Toggle between **Continue** and **Single**.

| Step | Description |
|---|---|
| 1. Set the sweep mode SWEEP [Sweep Mode] | Press the SWEEP hot key. Press the Sweep Mode soft key. Toggle between Continue and Single . |

Setting Trigger Source

TRIGGER



This hot key is used to select the trigger source among **Internal**, **External**, and **GPS**. The user input window must be inactive first to get the Trigger hot key function other than the number input.

Setting External Clock

To enhance the reliability of modulation analysis measurements the JD740A series must be synchronized with the Base Station. When an external clock is not supplied, the JD740A series works with a built-in internal high-accuracy time base. In this case, some measurement results may exhibit inaccurate values. Therefore, it is highly recommended to use the same reference clock as signal source. Trigger mode can be changed by using the **TRIGGER** hot key.

EXTERNAL CLOCK OPERATING STANDARDS

| Clock | Type | Reference | Port | Switching Standard |
|--------------------|----------|--------------------|---------------|--|
| External Reference | Internal | Internal 10 MHz | | Default |
| | External | External Ref Clock | Ext Ref (SMA) | Manual switching (Input signal level >-3 dBm) |
| | GPS | GPS Clock | GPS (SMA) | Automatic switching (GPS signal received) |
| Trigger | Internal | Internal Trigger | | Default |
| | External | External Trigger | Trigger (SMA) | Manual switching |
| | GPS | GPS | GPS (SMA) | Manual switching |

CONNECTION

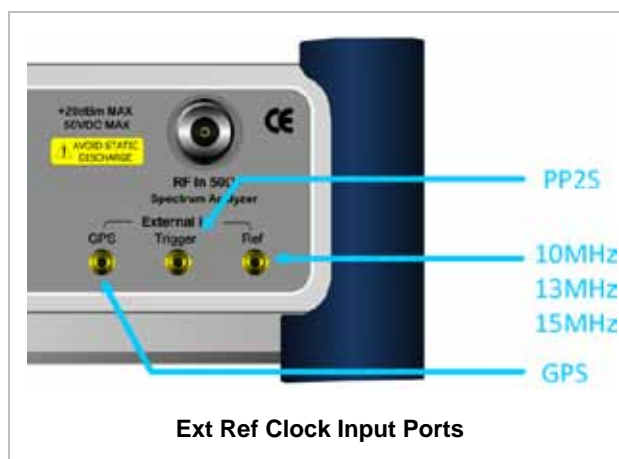

ENABLING EXTERNAL REFERENCE

| Step | Description |
|----------------------------------|---|
| 1. Connect an external reference | Connect one of the external references or a GPS antenna to the JD740A series. |

| | |
|--|---|
| <p>2. Change reference clock</p> <p>SYSTEM</p> <p>[Frequency Reference]</p> <p>[External 10 MHz], [External 13 MHz], [External 15 MHz] or [GPS]</p> | <p>Press the SYSTEM hot key.</p> <p>Press the Frequency Reference soft key to select one of the external reference clocks or GPS.</p> <p>Press one of the soft keys to choose among External 10 MHz, External 13 MHz, External 15 MHz, and GPS.</p> |
|--|---|

EXTERNAL REFERENCE INDICATOR INFORMATION

Each indicator tells different locking status according to a connection. When a GPS antenna is connected, longitude and latitude information will be displayed on the screen.

| Type | Indicator | Description |
|----------|--|----------------------------------|
| Internal |  (Green) | Locked |
| External |  (Green) | Locked |
| |  (Red) | Unlocked |
| GPS |  (Green) | Locked |
| |  (Yellow) | Locking in progress |
| |  (Gray) | Unable to lock or antenna failed |

CONSTELLATION

The Constellation is used to analyze transmitter modulation performance. The JD740A series displays the constellation diagram with modulation metrics to characterize the performance.

Measurement Procedure

| Step | Description |
|--|--|
| <p>1. Set the measurement mode</p> <p>MEASURE</p> <p>[Modulation Analysis]</p> <p>[Constellation]</p> | <p>Press the MEASURE hot key.</p> <p>Press the Modulation Analysis soft key.</p> <p>Press the Constellation soft key.</p> |
| <p>2. Set the measurement parameters</p> | |

| | |
|--|--|
| <p>MEASURE SETUP</p> <p>[Scramble] <Auto> or <Manual> Enter a value [Enter] or ENTER</p> <p>[Detect Mode] <HSDPA>, <WCDMA> or <HSDPA+></p> <p>[Threshold] Enter a value [dB] or ENTER</p> | <p>Press the MEASURE SETUP hot key.</p> <p>Press the Scramble soft key. The Auto mode is set by default. Toggle between Auto and Manual.</p> <p>Use the numeric keys to input value between 0 and 511.</p> <p>Press the Enter soft key or the ENTER hard key.</p> <p>Press the Detect Mode soft key. Each time this soft key is pressed, the selection changes.</p> <p>Press the Threshold soft key.</p> <p>Use the numeric keys to input value between -50 and 0.</p> <p>Press the unit soft key or the ENTER hard key.</p> |
|--|--|

WCDMA Constellation Measurement Procedure

MEASURE SETUP



- n **SCRAMBLE:** Sets the scramble code to **Auto** or **Manual**. Toggle between **Auto** and **Manual**. To change the value in the **Manual** mode, use the numeric keys to enter a value between 0 and 511 and press the **Enter** soft key or the **ENTER** hard key to complete to the input.
- n **DETECT MODE:** Selects the signal standard of **HSDPA**, **WCDMA** or **HSDPA+**. Default setting is **HSDPA**. Each time this soft key is pressed, the selection changes.
- n **TRHESHOLD:** Sets the threshold value. Default setting is -33 dB. Use the numeric keys to enter a value between -50 and 0 and then press the unit soft key or the **ENTER** hard key to complete to the input.

Setting Limit

LIMIT



This hot key is used to set the threshold value for the limit line on the display screen. It turns on or off the limit or band limit settings of the measurement for pass/fail indication. The user input window must be inactive first to get the Limit hot key function other than the number input.

| Step | Description |
|---|---|
| <p>1. Select the limit</p> <p>LIMIT</p> <p>[Modulation Test Limits]</p> <p>[Frequency Error]</p> | <p>Press the LIMIT hot key.</p> <p>Press the Modulation Test Limits soft key.</p> <p>Press the Frequency Error soft key.</p> |

| | |
|---|--|
| <p>[Test Limits] <On> or <Off></p> <p>[High Limit] [Low Limit]</p> <p>[EVM] [Test Limit] <On> or <Off> [High Limit]</p> <p>[PCDE] [Test Limit] <On> or <Off> [High Limit]</p> <p>[Carrier Feed Through] [Test Limit] <On> or <Off> [High Limit]</p> <p>[CPICH] [Test Limits] <On> or <Off> [High Limit (Abs)] [Low Limit (Abs)] or [High Limit (Rel)] [Low Limit (Rel)]</p> | <p>Press the Test Limits soft key. Toggle between On and Off.</p> <p>Use the numeric keys and input a number in ppm.</p> <p>Use the numeric keys and input a number in ppm.</p> <p>Press the EVM soft key.</p> <p>Press the Test Limit soft key. Toggle between On and Off.</p> <p>Use the numeric keys and input a number in %.</p> <p>Press the PCDE soft key.</p> <p>Press the Test Limit soft key. Toggle between On and Off.</p> <p>Use the numeric keys and input a number in dB.</p> <p>Press the Carrier Feed Through soft key.</p> <p>Press the Test Limit soft key. Toggle between On and Off.</p> <p>Use the numeric keys and input a number in dB.</p> <p>Press the CPICH soft key.</p> <p>Press the Test Limits soft key. Toggle between On and Off.</p> <p>Use the numeric keys and input a number in dBm.</p> <p>Use the numeric keys and input a number in dBm.</p> <p>Use the numeric keys and input a number in dB.</p> <p>Use the numeric keys and input a number in dB.</p> |
| <p>2. Enable beep</p> <p>LIMIT</p> <p>[Beep] <On> or <Off></p> | <p>Press the LIMIT hot key.</p> <p>Press the Beep soft key to toggle between On and Off and select one. This will make audible alarm if the measurement result goes beyond the limit.</p> |

n **FREQUENCY ERROR:** Sets the frequency error limit.

Y **TEST LIMITS:** Enables or disables the test limit(s). Toggle the **Test Limits** soft key between **On** and **Off**.

Y **HIGH LIMIT:** Sets the upper limit. Use the numeric keys to input value and press the unit soft key or the **ENTER** hard key to complete the input.

Y **LOW LIMIT:** Sets the lower limit. Use the numeric keys to input value and press the unit soft key or the **ENTER** hard key to complete the input.

- n **EVM:** Sets the error vector magnitude limit.
 - Y **TEST LIMIT:** Enables or disables the test limit(s). Toggle the **Test Limit** soft key between **On** and **Off**.
 - Y **HIGH LIMIT:** Sets the upper limit. Use the numeric keys to input value and press the unit soft key or the **ENTER** hard key to complete the input.
- n **PCDE:** Sets the peak code domain error limit.
 - Y **TEST LIMIT:** Enables or disables the test limit(s). Toggle the **Test Limit** soft key between **On** and **Off**.
 - Y **HIGH LIMIT:** Sets the upper limit. Use the numeric keys to input value and press the unit soft key or the **ENTER** hard key to complete the input.
- n **CARRIER FEED THROUGH:** Is a result of the RF carrier signal feeding through the I/Q modulator and riding on the output circuitry without being modulated. Sets the limit of carrier feed through.
 - Y **TEST LIMIT:** Enables or disables the test limit(s). Toggle the **Test Limit** soft key between **On** and **Off**.
 - Y **HIGH LIMIT:** Sets the upper limit. Use the numeric keys to input value and press the unit soft key or the **ENTER** hard key to complete the input.
- n **CPICH:** Sets the correlated power in coded channel limit.
 - Y **TEST LIMITS:** Enables or disables the test limit(s). Toggle the **Test Limits** soft key between **On** and **Off**.
 - Y **HIGH LIMIT (ABS):** Sets the upper absolute limit. Use the numeric keys to input value and press the unit soft key or the **ENTER** hard key to complete the input.
 - Y **LOW LIMIT (ABS):** Sets the lower absolute limit. Use the numeric keys to input value and press the unit soft key or the **ENTER** hard key to complete the input.
 - Y **HIGH LIMIT (REL):** Sets the upper relative limit. Use the numeric keys to input value and press the unit soft key or the **ENTER** hard key to complete the input.
 - Y **LOW LIMIT (REL):** Sets the lower relative limit. Use the numeric keys to input value and press the unit soft key or the **ENTER** hard key to complete the input.
- n **MAX INACTIVE:** *This key is not used in the Constellation mode.*

Measurement Example

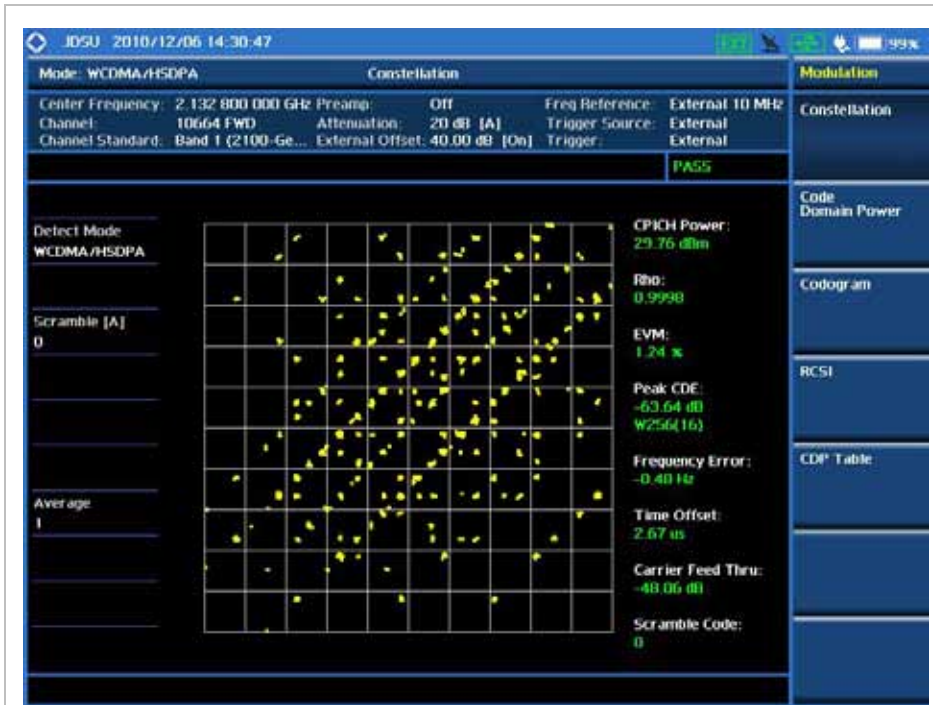

WCDMA Constellation Measurement Screen (TM2)

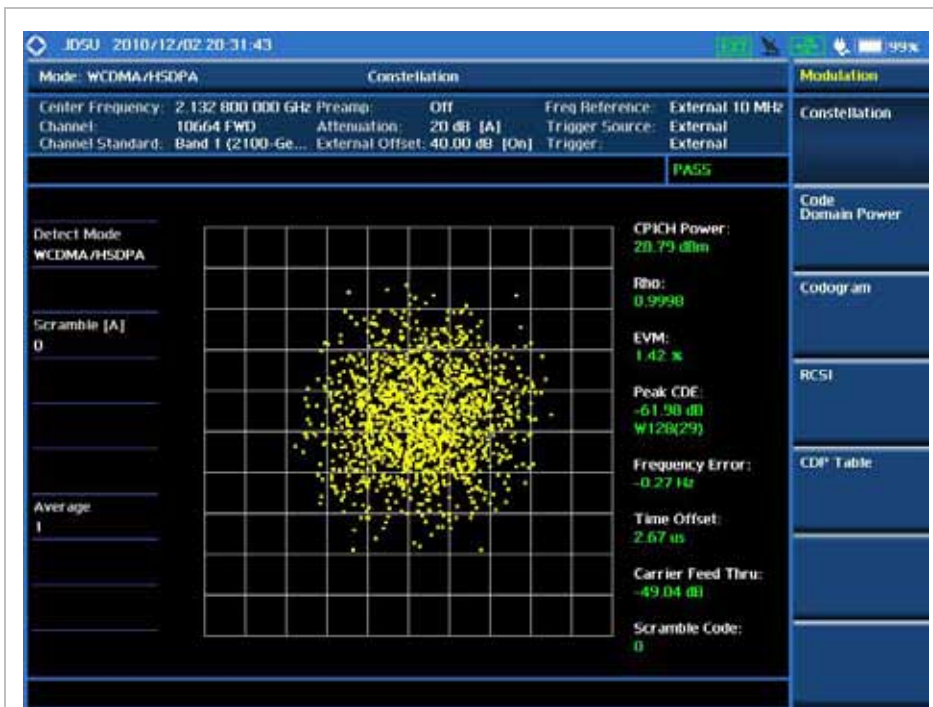

WCDMA Constellation Measurement Screen (TM5)

CODE DOMAIN POWER

The Code Domain Power (CDP) measurement provides code domain power analysis that measures the distribution of power across the set of code channels, normalized to the total power. It helps to verify that each code channel is operating at its proper level and to identify problems throughout the transmitter design from coding to the RF section. System imperfections such as amplifier non-linearity will present themselves as an undesired distribution of power in the code domain.

Measurement Procedure

| Step | Description |
|--|---|
| <p>1. Set the measurement mode</p> <p>MEASURE</p> <p>[Modulation Analysis]</p> <p>[Code Domain Power]</p> | <p>Press the MEASURE hot key.</p> <p>Press the Modulation Analysis soft key.</p> <p>Press the Code Domain Power soft key.</p> |
| <p>2. Set the measurement parameters</p> <p>MEASURE SETUP</p> <p>[Scramble]</p> <p><Auto> or <Manual></p> <p>Enter a value</p> <p>[Enter] or ENTER</p> <p>[Detect Mode]</p> <p><HSDPA>, <WCDMA> or <HSDPA+></p> <p>[Threshold]</p> <p>Enter a value</p> <p>[dB] or ENTER</p> <p>[S-CCPCH]</p> <p>[S-CCPCH]</p> <p><On> or <Off></p> <p>[Spread Factor]</p> <p>[4], [8], [16], [32], [64], [128], or [256]</p> <p>[Channel Number]</p> <p>Enter a value</p> <p>[Enter] or ENTER</p> | <p>Press the MEASURE SETUP hot key.</p> <p>Press the Scramble soft key. Toggle between Auto and Manual.</p> <p>Use the numeric keys to input value between 0 and 511.</p> <p>Press the Enter soft key or the ENTER hard key.</p> <p>Press the Detect Mode soft key. Each time this soft key is pressed, the selection changes.</p> <p>Press the Threshold soft key.</p> <p>Use the numeric keys to input value between -50 and 0.</p> <p>Press the unit soft key or the ENTER hard key.</p> <p>Press the S-CCPCH soft key.</p> <p>Press the S-CCPCH soft key in the S-CCPCH menu bar.</p> <p>Toggle this soft key between On and Off.</p> <p>Press the Spread Factor soft key.</p> <p>Press one of the spread factor soft keys to select.</p> <p>Press the Channel Number soft key.</p> <p>Use the numeric keys to input value.</p> <p>Press the Enter soft key or the ENTER hard key.</p> |

| | |
|--|--|
| [PICH] | Press the PICH soft key. |
| [PICH] <On> or <Off> | Press the PICH soft key in the PICH menu bar. Toggle this soft key between On and Off . |
| [Spread Factor] [4], [8], [16], [32], [64], [128], or [256] | Press the Spread Factor soft key. Press one of the spread factor soft keys to select. |
| [Channel Number] Enter a value [Enter] or ENTER | Press the Channel Number soft key. Use the numeric keys to input value. Press the Enter soft key or the ENTER hard key. |

WCDMA Code Domain Power Measurement Procedure

MEASURE SETUP



- n **SCRAMBLE:** Sets the scramble code to **Auto** or **Manual**. Toggle between **Auto** and **Manual**. To change the value in the **Manual** mode, use the numeric keys to enter a value between 0 and 511 and press the **Enter** soft key or the **ENTER** hard key to complete to the input.
- n **DETECT MODE:** Selects the signal standard of **HSDPA**, **WCDMA** or **HSDPA+**. Default setting is **HSDPA**. Each time this soft key is pressed, the selection changes.
- n **TRHESHOLD:** Sets the threshold value. Default setting is -27 dB. Use the numeric keys to enter a value between -50 and 0 and then press the unit soft key or the **ENTER** hard key to complete to the input.
- n **S-CCPCH:** Sets S-CCPCH information of the system to be tested.
 - Y **S-CCPCH:** Enables or disables the S-CCPCH. Toggle between **On** and **Off**.
 - Y **SPREAD FACTOR:** Selects the spreading factor among **4**, **8**, **16**, **32**, **64**, **128**, and **256**.
 - Y **CHANNEL NUMBER:** Sets the channel number. Use the numeric keys to enter a value and press the **Enter** soft key or the **ENTER** hard key to complete to the input.
- n **PICH:** Sets PICH information of the system to be tested.
 - Y **PICH:** Enables or disables the PICH. Toggle between **On** and **Off**.
 - Y **SPREAD FACTOR:** Selects the spreading factor among **4**, **8**, **16**, **32**, **64**, **128**, and **256**.
 - Y **CHANNEL NUMBER:** Sets the channel number. Use the numeric keys to enter a value and press the **Enter** soft key or the **ENTER** hard key to complete to the input.

Setting Limit

LIMIT



This hot key is used to set the threshold value for the limit line on the display screen. It turns on or off

the limit or band limit settings of the measurement for pass/fail indication. The user input window must be inactive first to get the Limit hot key function other than the number input.

| Step | Description |
|---|---|
| <p>1. Select the limit</p> <p>LIMIT</p> <p>[Modulation Test Limits]</p> <p>[CPICH]</p> <p>[Test Limits]</p> <p><On> or <Off></p> <p>[High Limit (Abs)]</p> <p>[Low Limit (Abs)]</p> <p>or</p> <p>[High Limit (Rel)]</p> <p>[Low Limit (Rel)]</p> <p>[Max Inactive]</p> <p>[Test Limit]</p> <p><On> or <Off></p> <p>[High Limit]</p> | <p>Press the LIMIT hot key.</p> <p>Press the Modulation Test Limits soft key.</p> <p>Press the CPICH soft key.</p> <p>Press the Test Limits soft key. Toggle between On and Off.</p> <p>Use the numeric keys and input a number in dBm.</p> <p>Use the numeric keys and input a number in dBm.</p> <p>Use the numeric keys and input a number in dBm.</p> <p>Use the numeric keys and input a number in dBm.</p> <p>Press the Max Inactive soft key.</p> <p>Press the Test Limit soft key. Toggle between On and Off.</p> <p>Use the numeric keys and input a number in dB.</p> |
| <p>2. Enable beep</p> <p>LIMIT</p> <p>[Beep]</p> <p><On> or <Off></p> | <p>Press the LIMIT hot key.</p> <p>Press the Beep soft key to toggle between On and Off and select one. This will make audible alarm if the measurement result goes beyond the limit.</p> |

- n **FREQUENCY ERROR:** *This key is not used in the Code Domain Power mode.*
- n **EVM:** *This key is not used in the Code Domain Power mode.*
- n **PCDE:** *This key is not used in the Code Domain Power mode.*
- n **CARRIER FEED THROUGH:** *This key is not used in the Code Domain Power mode.*
- n **CPICH:** Sets the CPICH power limit in dBm.
- Y **TEST LIMITS:** Enables or disables the test limit(s). Toggle the **Test Limits** soft key between **On** and **Off**.
- Y **HIGH LIMIT (ABS):** Sets the upper absolute limit. Use the numeric keys to input value and press the unit soft key or the **ENTER** hard key to complete the input.
- Y **LOW LIMIT (ABS):** Sets the lower absolute limit. Use the numeric keys to input value and press the unit soft key or the **ENTER** hard key to complete the input.
- Y **HIGH LIMIT (REL):** Sets the upper relative limit. Use the numeric keys to input value and press the unit soft key or the **ENTER** hard key to complete the input.

- Y **LOW LIMIT (REL):** Sets the lower relative limit. Use the numeric keys to input value and press the unit soft key or the **ENTER** hard key to complete the input.
- n **MAX INACTIVE:** Sets the limit of the highest level among inactive channels.
- Y **TEST LIMIT:** Enables or disables the test limit. Toggle the **Test Limit** soft key between **On** and **Off**.
- Y **HIGH LIMIT:** Sets the upper limit. Use the numeric keys to input value and press the unit soft key or the **ENTER** hard key to complete the input.

Setting Display

TRACE/DISPLAY



- n **VIEW:** Sets the view mode to full display or zoomed display. Toggle between **Full** and **Zoom**.
- n **POSITION:** Assigns the zoom start position. Use the numeric keys to input value and press the unit soft key or the **ENTER** hard key to complete the input. Valid numbers for the input vary to the Walsh code width set in the **Width** menu. This soft key is activated only when the **View** is set to **Zoom**.

| Walsh Code Width | Valid Start Position |
|------------------|----------------------|
| Width 32 | 0 to 15 |
| Width 64 | 0 to 7 |
| Width 128 | 0 to 3 |
| Width 256 | 0 to 1 |

- n **WIDTH:** Selects the Walsh code width to be displayed among **32, 64, 128,** and **256**. Each time the Width soft key is pressed, the highlighted selection changes. This soft key is activated only when the **View** is set to **Zoom**.
- n **CONSTELLATION:** Enables or disables the constellation chart on the Code Domain Power screen that shows current marker's code information. Toggle this soft key between **On** and **Off**.
- n **CONTROL CHANNELS:** Sets the control channels mode to normal or delta. Toggle this soft key between **Normal** and **Delta**.
 - Y **NORMAL:** Shows relative ratio of each control channel vs. total power.
 - Y **DELTA:** Shows relative ration of each control channel vs. CPICH channel.

Measurement Example

FULL SCREEN



WCDMA Code Domain Analysis Full Screen



WCDMA Code Domain Analysis Full Screen (with Constellation)

ZOOMED SCREEN (WALSH CODE 32)



WCDMA Code Domain Analysis Zoomed Screen (Walsh Code 32)



WCDMA Code Domain Analysis Zoomed Screen (with Constellation)

ZOOMED SCREEN (WALSH CODE 64)



WCDMA Code Domain Analysis Zoomed Screen (Walsh Code 64)



WCDMA Code Domain Analysis Zoomed Screen (with Constellation)

ZOOMED SCREEN (WALSH CODE 128)



WCDMA Code Domain Analysis Zoomed Screen (Walsh Code 128)



WCDMA Code Domain Analysis Zoomed Screen (with Constellation)

ZOOMED SCREEN (WALSH CODE 256)



WCDMA Code Domain Analysis Zoomed Screen (Walsh Code 256)

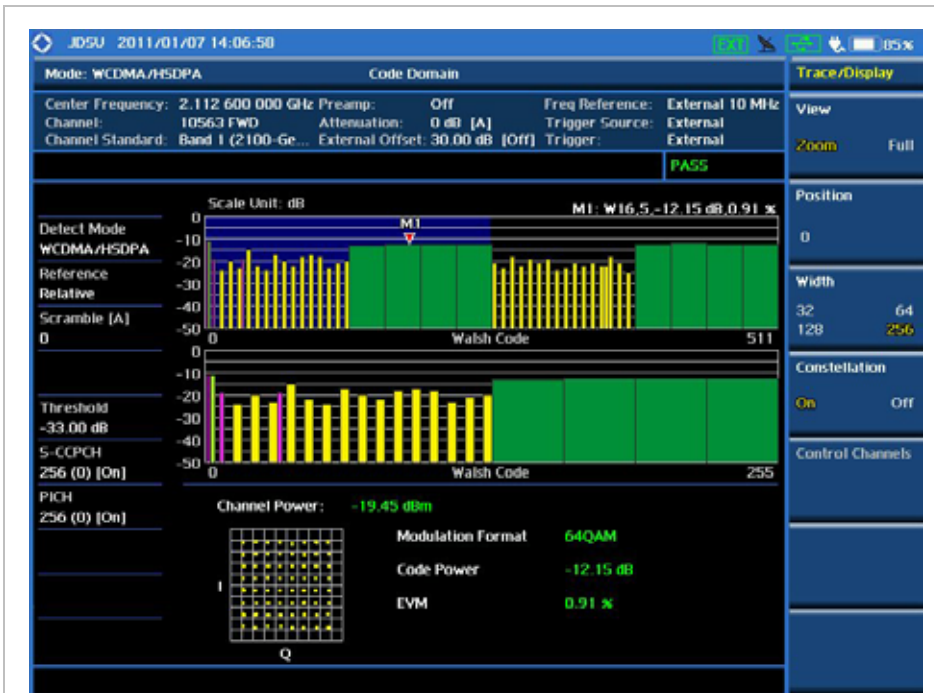

WCDMA Code Domain Analysis Zoomed Screen (with Constellation)

CODOGRAM

The Codogram shows how the code level is changing over time and makes it easier to see traffic channels as they initiate and terminate and to track traffic channels call levels over time. The Codogram measurements can be saved into an external USB memory so that a post-analysis can be done with the application software JDViewer.

Measurement Procedure

| Step | Description |
|--|--|
| 1. Set the measurement mode MEASURE [Modulation Analysis] [Codogram] | Press the MEASURE hot key. Press the Modulation Analysis soft key. Press the Codogram soft key. |
| 2. Set the measurement parameters MEASURE SETUP [Scramble] <Auto> or <Manual> Enter a value [Enter] or ENTER [Detect Mode] <HSDPA>, <WCDMA> or <HSDPA+> [S-CCPCH] [S-CCPCH] <On> or <Off> [Spread Factor] [4], [8], [16], [32], [64], [128], or [256] [Channel Number] Enter a value [Enter] or ENTER [PICH] [PICH] <On> or <Off> [Spread Factor] [4], [8], [16], [32], [64], | Press the MEASURE SETUP hot key. Press the Scramble soft key. Toggle between Auto and Manual . Use the numeric keys to input value between 0 and 511. Press the Enter soft key or the ENTER hard key. Press the Detect Mode soft key. Each time this soft key is pressed, the selection changes. Press the S-CCPCH soft key. Press the S-CCPCH soft key in the S-CCPCH menu bar. Toggle this soft key between On and Off . Press the Spread Factor soft key. Press one of the spread factor soft keys to select. Press the Channel Number soft key. Use the numeric keys to input value. Press the Enter soft key or the ENTER hard key. Press the PICH soft key. Press the PICH soft key in the PICH menu bar. Toggle this soft key between On and Off . Press the Spread Factor soft key. Press one of the spread factor soft keys to select. |

| | |
|--|--|
| <p>[128], or [256] [Channel Number] Enter a value [Enter] or ENTER</p> <p>[Threshold] Enter a value [dB]</p> <p>[Time Interval] Enter a value [Enter] or ENTER</p> <p>[Auto Save] <On> or <Off></p> | <p>Press the Channel Number soft key. Use the numeric keys to input value. Press the Enter soft key or the ENTER hard key.</p> <p>Press the Threshold soft key. Use the numeric keys to input value. Press the unit soft key.</p> <p>Press the Time Interval soft key. Use the numeric keys to input value in sec. Press the Enter soft key or the ENTER hard key.</p> <p>Press the Auto Save soft key. Toggle between On and Off.</p> |
| <p>3. Analyze the measurement result</p> <p>[Time Cursor] <On> or <Off></p> | <p>Press the Time Cursor soft key. Toggle between On and Off.</p> |

WCDMA Codogram Measurement Procedure

MEASURE SETUP



- n **RESET/RESTART:** Restarts the measurement.
- n **AUTO SAVE:** Enables or disables automatic saving of the measurement data to an external USB memory. When it turns on, the measurements will be recorded into the default file (codogram.cod) or a user-named file.
- n **TIME CURSOR:** Enables or disables the time cursor indicator. When the time cursor is enabled after specifying a number, measurement is put on hold and information of the specific number is updated on the measurement screen.
- n **TIME INTERVAL:** Sets the time interval in sec. Use the numeric keys to enter a value and press the **Enter** soft key or the **ENTER** hard key to complete to the input. 0 is the fastest measurement speed. As the time interval gets larger, the measurement speed is reduced.
- n **SCRAMBLE:** Sets the scramble code to **Auto** or **Manual**. Toggle between **Auto** and **Manual**. To change the value in the **Manual** mode, use the numeric keys to enter a value between 0 and 511 and press the **Enter** soft key or the **ENTER** hard key to complete to the input.
- n **DETECT MODE:** Selects the signal standard of **HSDPA**, **WCDMA**, or **HSDPA+**. Default setting is **HSDPA**. Each time this soft key is pressed, the selection changes.
- n **S-CCPCH**
 - Y **S-CCPCH:** Enables or disables the S-CCPCH. Toggle between **On** and **Off**.

- Y **SPREAD FACTOR:** Selects the spreading factor among **4, 8, 16, 32, 64, 128,** and **256**.
 - Y **CHANNEL NUMBER:** Sets the channel number. Use the numeric keys to enter a value and press the **Enter** soft key or the **ENTER** hard key to complete to the input.
- n **PICH**
- Y **PICH:** Enables or disables the PICH. Toggle between **On** and **Off**.
 - Y **SPREAD FACTOR:** Selects the spreading factor among **4, 8, 16, 32, 64, 128,** and **256**.
 - Y **CHANNEL NUMBER:** Sets the channel number. Use the numeric keys to enter a value and press the **Enter** soft key or the **ENTER** hard key to complete to the input.
- n **TRHESHOLD:** Sets the threshold value between Auto and Manual. Its default setting is -27 dB. To change the value in the **Manual** mode, use the numeric keys to enter a value between -50 and 0 and press the **Enter** soft key or the **ENTER** hard key to complete to the input.

Setting Display

TRACE/DISPLAY



- n **VIEW:** Sets the view mode to full display or zoomed display. Toggle between **Full** and **Zoom**.
- n **POSITION:** Assigns the zoom start position. Use the numeric keys to input value and press the unit soft key or the **ENTER** hard key to complete the input. Valid numbers for the input vary to the Walsh code width set in the **Width** menu.
- | Walsh Code Width | Valid Start Position |
|------------------|----------------------|
| Width 32 | 0 to 15 |
| Width 64 | 0 to 7 |
| Width 128 | 0 to 3 |
| Width 256 | 0 to 1 |
- This soft key is activated only when the **View** is set to **Zoom**.
- n **WIDTH:** Selects the Walsh code width to be displayed among **32, 64, 128,** and **256**. Each time the Width soft key is pressed, the highlighted selection changes. This soft key is activated only when the **View** is set to **Zoom**.

Measurement Example

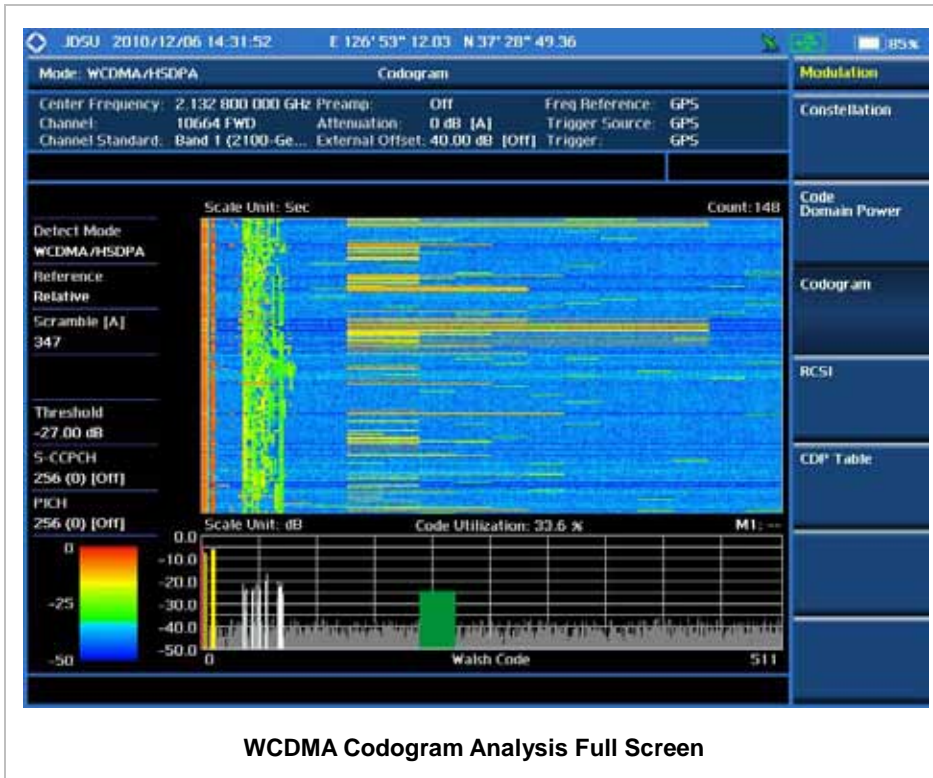

WCDMA Codogram Analysis Full Screen

RCSI

The Received Code Strength indicator (RCSI) is used to track the code channels such as CPICH, P-CCPCH, S-CCPCH, PICH, P-SCH, and S-SCH and it is particularly useful to observe signal fluctuations of the dedicated control channels over the time. The RCSI measurements can be saved into an external USB memory so that a post-analysis can be done with the application software JDViewer.

Measurement Procedure

| Step | Description |
|---|---|
| 1. Set the measurement mode MEASURE [Modulation Analysis] [RCSI] | Press the MEASURE hot key. Press the Modulation Analysis soft key. Press the RCSI soft key. |
| 2. Set the measurement parameters MEASURE SETUP [Scramble] <Auto> or <Manual> | Press the MEASURE SETUP hot key. Press the Scramble soft key. Toggle between Auto and Manual . |

| | |
|--|--|
| <p>Enter a value [Enter] or ENTER</p> | <p>Use the numeric keys to input value between 0 and 511. Press the Enter soft key or the ENTER hard key.</p> |
| <p>[Detect Mode] <HSDPA>, <WCDMA> or <HSDPA+></p> | <p>Press the Detect Mode soft key. Each time this soft key is pressed, the selection changes.</p> |
| <p>[S-CCPCH] [S-CCPCH] <On> or <Off> [Spread Factor] [4], [8], [16], [32], [64], [128], or [256] [Channel Number] Enter a value [Enter] or ENTER</p> | <p>Press the S-CCPCH soft key. Press the S-CCPCH soft key in the S-CCPCH menu bar. Toggle this soft key between On and Off. Press the Spread Factor soft key. Press one of the spread factor soft keys to select.</p> <p>Press the Channel Number soft key. Use the numeric keys to input value. Press the Enter soft key or the ENTER hard key.</p> |
| <p>[PICH] [PICH] <On> or <Off> [Spread Factor] [4], [8], [16], [32], [64], [128], or [256] [Channel Number] Enter a value [Enter] or ENTER</p> | <p>Press the PICH soft key. Press the PICH soft key in the PICH menu bar. Toggle this soft key between On and Off. Press the Spread Factor soft key. Press one of the spread factor soft keys to select.</p> <p>Press the Channel Number soft key. Use the numeric keys to input value. Press the Enter soft key or the ENTER hard key.</p> |
| <p>[Threshold] Enter a value [dB]</p> | <p>Press the Threshold soft key. Use the numeric keys to input value. Press the unit soft key.</p> |
| <p>[Alarm Code] [None], [CPICH], [PCCPCH], [P-SCH], [S-SCH], [SCCPCH], or [PICH]</p> | <p>Press the Alarm Code soft key. Press the alarm code soft key to select. SCCPCH and PICH are activated only when they are set to On in the Measure Setup.</p> |
| <p>[Set Mask] Enter a value [dB] or [dBm]</p> | <p>Press the Set Mask soft key and enter a value. Use the numeric keys to input value. Press the unit soft key. The unit changes according to the reference setting (relative or absolute) in Amp/Scale.</p> |
| <p>[Auto Save] <On> or <Off></p> | <p>Press the Auto Save soft key. Toggle between On and Off.</p> |

WCDMA RCSI Measurement Procedure

MEASURE SETUP



- n **RESET/RESTART:** Restarts the measurement.
- n **AUTO SAVE:** Enables or disables automatic saving of the measurement data to an external USB memory. When it turns on, the measurements will be recorded into the default file (rcsi.rcs) or a user-named file.
- n **ALARM CODE:** Selects the alarm code among **None**, **CPICH**, **P-CCPCH**, **S-CCPCH**, **PICH**, **P-SCH**, and **S-SCH**. S-CCPCH and PICH soft keys are activated only when they are set to On in the Measure Setup menu.
- n **SET MASK:** Sets the alarm mask value in dB for relative mode or dBm in absolute mode. The unit changes to dB or dBm according to the reference setting (relative or absolute) in the Amp/Scale menu. Use the numeric keys to enter a value and press the unit soft key or the **ENTER** hard key to complete to the input.
- n **SCRAMBLE:** Sets the scramble code to **Auto** or **Manual**. Toggle between **Auto** and **Manual**. To change the value in the **Manual** mode, use the numeric keys to enter a value between 0 and 511 and press the **Enter** soft key or the **ENTER** hard key to complete to the input.
- n **DETECT MODE:** Selects the signal standard of **HSDPA**, **WCDMA**, or **HSDPA+**. Default setting is **HSDPA**. Each time this soft key is pressed, the selection changes.
- n **S-CCPCH**
 - Y **S-CCPCH:** Enables or disables the S-CCPCH. Toggle between **On** and **Off**.
 - Y **SPREAD FACTOR:** Selects the spreading factor among **4**, **8**, **16**, **32**, **64**, **128**, and **256**.
 - Y **CHANNEL NUMBER:** Sets the channel number. Use the numeric keys to enter a value and press the **Enter** soft key or the **ENTER** hard key to complete to the input.
- n **PICH**
 - Y **PICH:** Enables or disables the PICH. Toggle between **On** and **Off**.
 - Y **SPREAD FACTOR:** Selects the spreading factor among **4**, **8**, **16**, **32**, **64**, **128**, and **256**.
 - Y **CHANNEL NUMBER:** Sets the channel number. Use the numeric keys to enter a value and press the **Enter** soft key or the **ENTER** hard key to complete to the input.
- n **TRHESHOLD:** Sets the threshold value between Auto and Manual. Its default setting is -27 dB. To change the value in the **Manual** mode, use the numeric keys to enter a value between -50 and 0 and press the **Enter** soft key or the **ENTER** hard key to complete to the input.

Setting Display

TRACE/DISPLAY 

n **VIEW:** Sets the view mode to full display or zoomed display. Toggle between **Full** and **Zoom**.

n **POSITION:** Assigns the zoom start position. Use the numeric keys to input value and press the unit soft key or the **ENTER** hard key to complete the input. Valid numbers for the input vary to the Walsh code width set in the **Width** menu.

| Walsh Code Width | Valid Start Position |
|------------------|----------------------|
| Width 32 | 0 to 15 |
| Width 64 | 0 to 7 |
| Width 128 | 0 to 3 |
| Width 256 | 0 to 1 |

This soft key is activated only when the **View** is set to **Zoom**.

n **WIDTH:** Selects the Walsh code width to be displayed among **32, 64, 128, and 256**. Each time the Width soft key is pressed, the highlighted selection changes. This soft key is activated only when the **View** is set to **Zoom**.

Measurement Example



WCDMA RCSI Analysis Full Screen (Walsh Code 512)

CDP TABLE

The CDP Table is used for the user to look at a numeric and textual description of all the active code channels in the signal.

Measurement Procedure

| Step | Description |
|--|---|
| 1. Set the measurement mode MEASURE [Modulation Analysis] [CDP Table] | Press the MEASURE hot key. Press the Modulation Analysis soft key. Press the CDP Table soft key. |
| 2. Set the measurement parameters MEASURE SETUP [Scramble] <Auto> or <Manual> Enter a value [Enter] or ENTER [Detect Mode] <HSDPA>, <WCDMA> or <HSDPA+> [Threshold] Enter a value [dB] or ENTER [S-CCPCH] [S-CCPCH] <On> or <Off> [Spread Factor] [4], [8], [16], [32], [64], [128], or [256] [Channel Number] Enter a value [Enter] or ENTER [PICH] [PICH] <On> or <Off> | Press the MEASURE SETUP hot key. Press the Scramble soft key. Toggle between Auto and Manual . Use the numeric keys to input value between 0 and 511. Press the Enter soft key or the ENTER hard key. Press the Detect Mode soft key. Each time this soft key is pressed, the selection changes. Press the Threshold soft key. Use the numeric keys to input value between -50 and 0. Press the unit soft key or the ENTER hard key. Press the S-CCPCH soft key. Press the S-CCPCH soft key in the S-CCPCH menu bar. Toggle this soft key between On and Off . Press the Spread Factor soft key. Press one of the spread factor soft keys to select. Press the Channel Number soft key. Use the numeric keys to input value. Press the Enter soft key or the ENTER hard key. Press the PICH soft key. Press the PICH soft key in the PICH menu bar. Toggle this soft key between On and Off . |

| | |
|--|--|
| <p>[Spread Factor] [4], [8], [16], [32], [64], [128], or [256]</p> <p>[Channel Number] Enter a value [Enter] or ENTER</p> | <p>Press the Spread Factor soft key. Press one of the spread factor soft keys to select.</p> <p>Press the Channel Number soft key. Use the numeric keys to input value. Press the Enter soft key or the ENTER hard key.</p> |
|--|--|

WCDMA CDP Table Measurement Procedure

MEASURE SETUP



- n **SCRAMBLE:** Sets the scramble code to **Auto** or **Manual**. Toggle between **Auto** and **Manual**. To change the value in the **Manual** mode, use the numeric keys to enter a value between 0 and 511 and press the **Enter** soft key or the **ENTER** hard key to complete to the input.
- n **TRHESHOLD:** Sets the threshold value. Default setting is -27 dB. Use the numeric keys to enter a value between -50 and 0 and then press the unit soft key or the **ENTER** hard key to complete to the input.
- n **S-CCPCH**
 - Y **S-CCPCH:** Enables or disables the S-CCPCH. Toggle between **On** and **Off**.
 - Y **SPREAD FACTOR:** Selects the spreading factor among **4, 8, 16, 32, 64, 128, and 256**.
 - Y **CHANNEL NUMBER:** Sets the channel number. Use the numeric keys to enter a value and press the **Enter** soft key or the **ENTER** hard key to complete to the input.
- n **PICH**
 - Y **PICH:** Enables or disables the PICH. Toggle between **On** and **Off**.
 - Y **SPREAD FACTOR:** Selects the spreading factor among **4, 8, 16, 32, 64, 128, and 256**.
 - Y **CHANNEL NUMBER:** Sets the channel number. Use the numeric keys to enter a value and press the **Enter** soft key or the **ENTER** hard key to complete to the input.

Setting Display

TRACE/DISPLAY



- n **PAGE UP:** Scrolls up the page to the previous screen.
- n **PAGE DOWN:** Scrolls down the page to the next screen.

Measurement Example

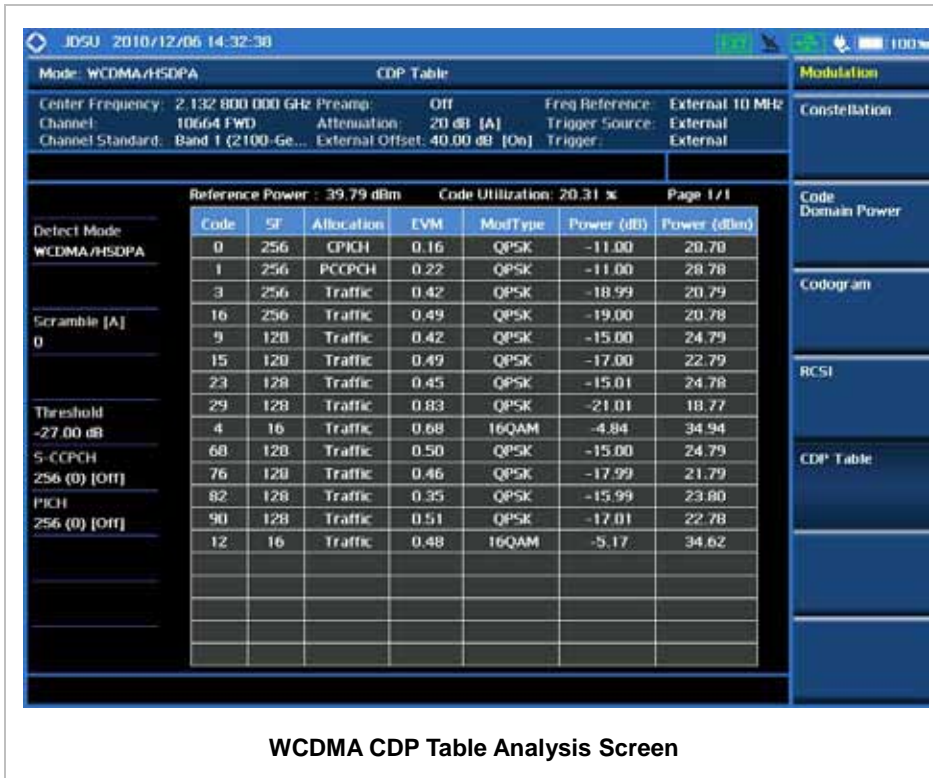

WCDMA CDP Table Analysis Screen

AUTO MEASUREMENT

The Auto Measure function of the JD740A series allows a complete signal profiling covering RF characterization and modulation quality parameters of up to 10 different carriers, particularly useful on an overlay architecture where base stations are transmitting in different frequencies.

The Auto Measure can be easily executed either by selecting a menu in the instrument or by running a programmed scenario in the PC-based application so that the instrument automatically configure and perform tests on every aspect of all the carriers.

Setting Mode

| Step | Description |
|---|--|
| 1. Connect the cable | Connect a cable directly or indirectly as shown in the section Connecting a Cable on page 7 of this chapter. |
| 2. Select the mode MODE [Signal Analyzer] | Press the MODE hard key. Press the Signal Analyzer soft key. |

| | |
|-----------------------|---|
| [WCDMA] | Press the WCDMA soft key. |
| [Auto Measure] | Press the Auto Measure soft key. |

Following settings are required only when you run Auto Measure on the instrument using “Current” configuration setting. Additional settings are not required when you run Auto Measure using a scenario generated in the PC application software, JDViewer.

Setting Frequency

| Step | Description |
|--|--|
| <p>1. Set the frequency</p> <p>FREQ/DIST</p> <p>[Unit] <Freq> or <Channel></p> <p><i>When Freq is selected:</i></p> <p>[Center Frequency] Enter a value [GHz], [MHz], [kHz], or [Hz]</p> <p><i>When Channel is selected:</i></p> <p>[Channel Standard]</p> <p>Select a channel standard</p> <p>[Select] or ENTER</p> <p>[Channel Number] Enter a value [Forward]</p> | <p>Press the FREQ/DIST hard key.</p> <p>Press the Unit soft key. Toggle this key between Freq and Channel. A set of Freq/Dist screen menu changes accordingly.</p> <p>Press the Center Frequency soft key. Use the numeric keys, the rotary knob, or the arrow keys. When using the numeric keys, the input is completed by selecting one of the unit soft keys.</p> <p>Press the Channel Standard soft key. If this channel standard shows its default setting Band Global, go set the channel number directly. Press the arrow keys, rotate the knob, or press the Page Up and Page Down soft keys to highlight a frequency band to select.</p> <p>Press the Select soft key or the ENTER hard key.</p> <p>Press the Channel Number soft key. Use the numeric keys to input value and press the Forward soft key to complete the input. The instrument automatically displays its corresponding center frequency value for the channel number.</p> |

FREQ/DIST



n **UNIT:** Determines the way how to set the frequency band either with standard band or custom

frequency band. Toggling this key between **Freq** and **Channel** changes a set of Freq/Dist screen menu automatically. When the **Channel** is selected, the instrument sets the **Channel Standard** setting to **Band Global** as default so that the user can set the **Channel Number** directly without choosing a standard channel band from the list.

- n **CENTER FREQUENCY:** Changes the center frequency setting. Use the rotary knob or the arrow keys. Or use the numeric keys to input a certain value and press one of the unit soft keys to complete the input.
- n **FREQUENCY STEP:** Defines the amount of frequency to be increased or decreased when using the rotary knob or the arrow keys to change the **Center Frequency**. This frequency step size can be entered by using numeric keys and the unit soft keys.
- n **CHANNEL NUMBER:** Enters a channel number. The instrument automatically displays its corresponding center frequency value for the channel number.
- n **CHANNEL STEP:** Defines the amount of channel to be increased or decreased when using the rotary knob or the arrow keys to change the **Channel Number**. This channel step size can be entered by using numeric keys and the **Enter** soft key.
- n **CHANNEL STANDARD:** When the channel standard is selected from the list, the center frequency information on the display screen will be mapped accordingly to the selected channel standard. The channel standards available in the instrument are listed in the Appendix C – Band, Frequency & Channel Standard.

Setting Trigger Source



This hot key is used to select the trigger source among **Internal**, **External**, and **GPS**. The user input window must be inactive first to get the Trigger hot key function other than the number input.

Setting External Clock

To enhance the reliability of modulation analysis measurements the JD740A series must be synchronized with the Base Station. When an external clock is not supplied, the JD740A series works with a built-in internal high-accuracy time base. In this case, some measurement results may exhibit inaccurate values. Therefore, it is highly recommended to use the same reference clock as signal source. Trigger mode can be changed by using the **TRIGGER** hot key.

EXTERNAL CLOCK OPERATING STANDARDS

| Clock | Type | Reference | Port | Switching Standard |
|--------------------|----------|--------------------|---------------|--|
| External Reference | Internal | Internal 10 MHz | | Default |
| | External | External Ref Clock | Ext Ref (SMA) | Manual switching (Input signal level >-3 dBm) |
| | GPS | GPS Clock | GPS (SMA) | Automatic switching (GPS signal received) |
| Trigger | Internal | Internal Trigger | | Default |
| | External | External Trigger | Trigger (SMA) | Manual switching |
| | GPS | GPS | GPS (SMA) | Manual switching |

CONNECTION

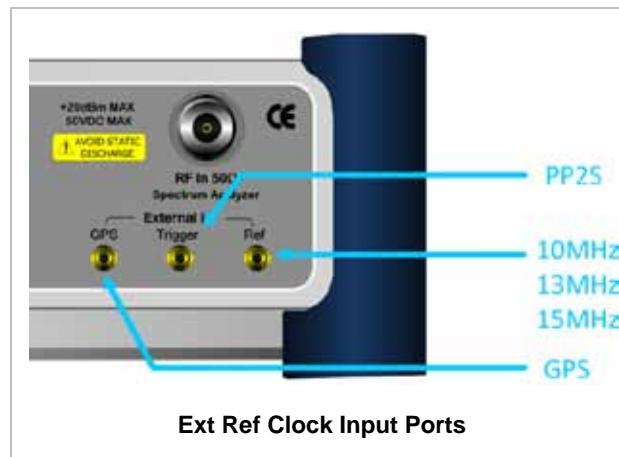



ENABLING EXTERNAL REFERENCE

| Step | Description |
|---|--|
| 1. Connect an external reference | Connect one of the external references or a GPS antenna to the JD740A series. |
| 2. Change reference clock SYSTEM [Frequency Reference] [External 10 MHz], [External 13 MHz], [External 15 MHz] or [GPS] | Press the SYSTEM hot key. Press the Frequency Reference soft key to select one of the external reference clocks or GPS. Press one of the soft keys to choose among External 10 MHz , External 13 MHz , External 15 MHz , and GPS . |

EXTERNAL REFERENCE INDICATOR INFORMATION

Each indicator tells different locking status according to a connection. When a GPS antenna is connected, longitude and latitude information will be displayed on the screen.

| Type | Indicator | Description |
|----------|--|----------------------------------|
| Internal |  (Green) | Locked |
| External |  (Green) | Locked |
| |  (Red) | Unlocked |
| GPS |  (Green) | Locked |
| |  (Yellow) | Locking in progress |
| |  (Gray) | Unable to lock or antenna failed |

Setting Limit



This hot key is used to set the threshold value for the limit line on the display screen. It turns on or off the limit or band limit settings of the measurement for pass/fail indication. The user input window must be inactive first to get the Limit hot key function other than the number input.

| Step | Description |
|--|--|
| 1. Set the RF test limit LIMIT [RF Test Limits] [Channel Power] [Test Limits] <On> or <Off> [High Limit] Enter a value [dBm] or ENTER [Low Limit] Enter a value [dBm] or ENTER [Occupied BW] [Test Limit] <On> or <Off> [High Limit] | Press the LIMIT hot key. Press the RF Test Limits soft key. Press the Channel Power soft key. Press the Test Limits soft key to toggle between On and Off and select one. Press the High Limit soft key to set the upper limit of the Pass/Fail criteria. Use the numeric keys to input value. Press the unit soft key or the ENTER hard key. Press the Low Limit soft key to set the lower limit of the Pass/Fail criteria. Use the numeric keys to input value. Press the unit soft key or the ENTER hard key. Press the Occupied BW soft key. Press the Test Limit soft key to toggle between On and Off and select one. Press the High Limit soft key to set the upper limit of the |

| | |
|--|--|
| <p>Enter a value [MHz], [kHz], or [Hz]</p> <p>[Spectrum Emission Mask] [Test Limit] <On> or <Off></p> <p>[ACLR] [Test Limit] <On> or <Off></p> <p>[Multi-ACLR] [Test Limit] <On> or <Off></p> <p>[Spurious Emissions] [Test Limit] <On> or <Off></p> | <p>Pass/Fail criteria. Use the numeric keys to input value. Press the unit soft key to select.</p> <p>Press the Spectrum Emission Mask soft key. Press the Test Limit soft key to toggle between On and Off and select one.</p> <p>Press the ACLR soft key. Press the Test Limit soft key to toggle between On and Off and select one.</p> <p>Press the Multi-ALPR soft key. Press the Test Limit soft key to toggle between On and Off and select one.</p> <p>Press the Spurious Emissions soft key. Press the Test Limit soft key to toggle between On and Off and select one.</p> |
| <p>2. Enable beep LIMIT [Beep] <On> or <Off></p> | <p>Press the LIMIT hot key. Press the Beep soft key to toggle between On and Off and select one. This will make audible alarm if the measurement result goes beyond the limit.</p> |

n **CHANNEL POWER:** Sets the test limit parameters.

Y **TEST LIMITS:** Enables or disables Pass/Fail results on the display screen. Toggle the **Test Limits** soft key to set it to **On** or **Off**.

Y **HIGH LIMIT:** Sets the upper limit of the Pass/Fail criteria. Use the numeric keys to enter a threshold or limit value and press the **dBm** unit soft key or the **ENTER** hard key to complete the input.

Y **LOW LIMIT:** Sets the lower limit of the Pass/Fail criteria. Use the numeric keys to enter a threshold or limit value and press the **dBm** unit soft key or the **ENTER** hard key to complete the input.

n **OCCUPIED BW:** Sets the test limit parameters.

Y **TEST LIMIT:** Enables or disables Pass/Fail results on the display screen. Toggle the **Test Limit** soft key to set it to **On** or **Off**.

Y **HIGH LIMIT:** Sets the upper limit of the Pass/Fail criteria. Use the numeric keys to enter a threshold or limit value and press one of the unit soft keys to complete the input.

n **SPECTRUM EMISSION MASK:** Sets the test limit parameter.

| | |
|--|--|
| Enter a value [Min] | Use the numeric keys to input value in minutes. Press the Min soft key to complete the input. |
| [Save Result] [File Name] | Press the Save Result soft key. Press the File Name soft key to assign a specific name to the test result. |
| [Save to] <Internal> or <USB> | Press the Save to soft key to select where to save the test result. Toggle this soft key between Internal and USB . |
| [Save Screen] <All> or <Fail> | Press the Save Screen soft key to choose its save option. Toggle this soft key between All and Fail . This key is activated only when the Save to is set to USB . |
| [Run Test] | Press the Run Test soft key to run a test. |

WCDMA Auto Measurement Procedure

MEASURE SETUP



- n **RUN TEST:** Starts a test.
- n **CONFIGURATION:** Selects the measurement configuration to be used. When the **Current** is selected, the instrument runs a test using current carrier frequency (single carrier) and determines pass/fail based on the instrument's limit settings. Select the **Scenario** to run a test with a programmed scenario.
- n **LOAD SCENARIO:** Selects and loads a scenario file generated by the PC application software, JDViewer. This soft key is activated only when the **Configuration** is set to **Scenario**.
- n **TEST TIME:** Selects the test time. When **Now** is selected, the instrument runs a test only once. When **Schedule** is selected, the instrument repeats tests as defined in the **Set Timing** menu.
- n **SET TIMING:** Sets the **Start Time**, **Stop Time**, and **Time Interval** of a scheduled measurement. This soft key is activated only when the **Test Time** is set to **Schedule**.
- n **SAVE RESULT:** Sets parameters for saving measurement results. The instrument automatically saves measurement results in *.CSV format as well so that they can be imported in an application software that supports the CSV format.
 - Y **FILE NAME:** Sets the measurement result file name.
 - Y **SAVE TO:** Sets the destination where the result to be saved, **Internal** or **USB**.
 - Y **SAVE SCREEN:** Selects what results to be saved into a USB drive. Toggle this soft key between **All** for all the measurement items and **Fail** for failed items only. This key is activated only when the **Save to** is set to **USB**.
- n **EXTERNAL OFFSET:** Sets an external offset value. An offset consists of a cable loss and a user offset and the measurement result shows the value reflecting both offset values. When the

external offset value is set at 40 dB in the Spectrum mode, the measurement result compensates 40 dB at both the Spectrum Analyzer and Signal Analyzer modes.

Setting Display



- n **DISPLAY:** Changes the display option. After running automatic measurement, toggle this key between **Results** and **Settings**.
 - Y **RESULTS:** Shows actual measurement results on the display screen.
 - Y **SETTINGS:** Shows measurement parameters set for the automatic measurement.
- n **DISPLAY RESULTS:** Changes the display format of measurement results. This key becomes activated when the **Results** is set as the display option. Toggle this key between **Full** and **Quick** to check measurement results in different format.
 - Y **FULL:** Shows detailed measurement results, including actual measurement readings with pass/fail color indication.
 - Y **QUICK:** Shows quick view of pass/fail results.
- n **VIEW CARRIER:** Selects a carrier to be displayed among up to 10 carriers. This key becomes activated when the **Results** is set as the display option.

POWER STATISTICS CCDF

Power Statistics Complementary Cumulative Distribution Function (CCDF) measurement characterizes the power statistics of input signal. It provides PAR (Peak to Average power Ratio) versus different probabilities.

Setting Mode

| Step | Description |
|-----------------------------------|--|
| 1. Connect the cable | Connect a cable directly or indirectly as shown in the section Connecting a Cable on page 7 of this chapter. |
| 2. Select the mode MODE | Press the MODE hard key. |

| | |
|---|---|
| <p>[Signal Analyzer] [WCDMA] [Power Statistics CCDF]</p> | <p>Press the Signal Analyzer soft key. Press the WCDMA soft key. Press the Power Statistics CCDF soft key.</p> |
|---|---|

Setting Frequency

| Step | Description |
|---|--|
| <p>1. Set the frequency</p> <p>FREQ/DIST</p> <p>[Unit] <Freq> or <Channel></p> <p><i>When Freq is selected:</i></p> <p>[Center Frequency] Enter a value [GHz], [MHz], [kHz], or [Hz]</p> <p><i>When Channel is selected:</i></p> <p>[Channel Standard] Select a channel standard</p> <p>[Select] or ENTER</p> <p>[Channel Number] Enter a value [Forward]</p> | <p>Press the FREQ/DIST hard key.</p> <p>Press the Unit soft key. Toggle this key between Freq and Channel. A set of Freq/Dist screen menu changes accordingly.</p> <p>Press the Center Frequency soft key. Use the numeric keys, the rotary knob, or the arrow keys. When using the numeric keys, the input is completed by selecting one of the unit soft keys.</p> <p>Press the Channel Standard soft key. If this channel standard shows its default setting Band Global, go set the channel number directly. Press the arrow keys, rotate the knob, or press the Page Up and Page Down soft keys to highlight a frequency band to select.</p> <p>Press the Select soft key or the ENTER hard key.</p> <p>Press the Channel Number soft key. Use the numeric keys to input value and press the Forward soft key to complete the input. The instrument automatically displays its corresponding center frequency value for the channel number.</p> |



- n **UNIT:** Determines the way how to set the frequency band either with standard band or custom frequency band. Toggling this key between **Freq** and **Channel** changes a set of Freq/Dist screen menu automatically. When the **Channel** is selected, the instrument sets the **Channel Standard** setting to **Band Global** as default so that the user can set the **Channel Number** directly without choosing a standard channel band from the list.

- n **CENTER FREQUENCY:** Changes the center frequency setting. Use the rotary knob or the arrow keys. Or use the numeric keys to input a certain value and press one of the unit soft keys to complete the input.
- n **FREQUENCY STEP:** Defines the amount of frequency to be increased or decreased when using the rotary knob or the arrow keys to change the **Center Frequency**. This frequency step size can be entered by using numeric keys and the unit soft keys.
- n **CHANNEL NUMBER:** Enters a channel number. The instrument automatically displays its corresponding center frequency value for the channel number.
- n **CHANNEL STEP:** Defines the amount of channel to be increased or decreased when using the rotary knob or the arrow keys to change the **Channel Number**. This channel step size can be entered by using numeric keys and the **Enter** soft key.
- n **CHANNEL STANDARD:** When the channel standard is selected from the list, the center frequency information on the display screen will be mapped accordingly to the selected channel standard. The channel standards available in the instrument are listed in the Appendix C – Band, Frequency & Channel Standard.

Setting Amplitude

| Step | Description |
|--|---|
| 1. Set the reference/attenuation level AMP/SCALE [Auto Scale] or [Attenuation] <Manual> Enter an attenuation value | Press the AMP/SCALE hard key. Press the Auto Scale soft key to automatically set optimum levels of reference and attenuation. Press the Attenuation soft key. The Auto mode is set by default. This key toggles between the Auto and Manual . Press the Attenuation soft key to highlight the Manual mode and change the attenuation value to optimize S/N. Use the numeric keys or the rotary knob that changes in a 5 dB step. The attenuation setting range is 0 to 50 dB. |

AMP/SCALE



- n **AUTO SCALE:** The instrument can automatically set the scale to the minimum and maximum values on the Y-axis of the graph for optimum display of the traces measured. Each time the **Auto Scale** is selected, the top and bottom scales are set to the minimum and maximum values with margin on the Y-axis of the display screen.

n ATTENUATION

- Y **AUTO:** Input attenuator's value is automatically set depending on the reference level. This is the default operation mode, so it is recommended to use this mode unless a special measurement condition is needed.
- Y **MANUAL:** Sets the attenuator's value for the **Spectrum Analyzer RF In 50 Ω** port.

Setting Sweep Mode

SWEEP

This hot key is used to set the sweep parameters. The user input window must be inactive first to get the Sweep hot key function other than the number input.

- n **SWEEP MODE:** Sets the sweep method. Toggle between **Continue** and **Single**.

| Step | Description |
|--|---|
| 1. Set the sweep mode SWEEP [Sweep Mode] | Press the SWEEP hot key. Press the Sweep Mode soft key. Toggle between Continue and Single . |

Setting Trigger Source

TRIGGER

This hot key is used to select the trigger source among **Internal**, **External**, and **GPS**. The user input window must be inactive first to get the Trigger hot key function other than the number input.

Setting External Clock

To enhance the reliability of modulation analysis measurements the JD740A series must be synchronized with the Base Station. When an external clock is not supplied, the JD740A series works with a built-in internal high-accuracy time base. In this case, some measurement results may exhibit inaccurate values. Therefore, it is highly recommended to use the same reference clock as signal source. Trigger mode can be changed by using the **TRIGGER** hot key.

EXTERNAL CLOCK OPERATING STANDARDS

| Clock | Type | Reference | Port | Switching Standard |
|--------------------|----------|--------------------|---------------|--|
| External Reference | Internal | Internal 10 MHz | | Default |
| | External | External Ref Clock | Ext Ref (SMA) | Manual switching (Input signal level >-3 dBm) |
| | GPS | GPS Clock | GPS (SMA) | Automatic switching (GPS signal received) |
| Trigger | Internal | Internal Trigger | | Default |
| | External | External Trigger | Trigger (SMA) | Manual switching |
| | GPS | GPS | GPS (SMA) | Manual switching |

CONNECTION

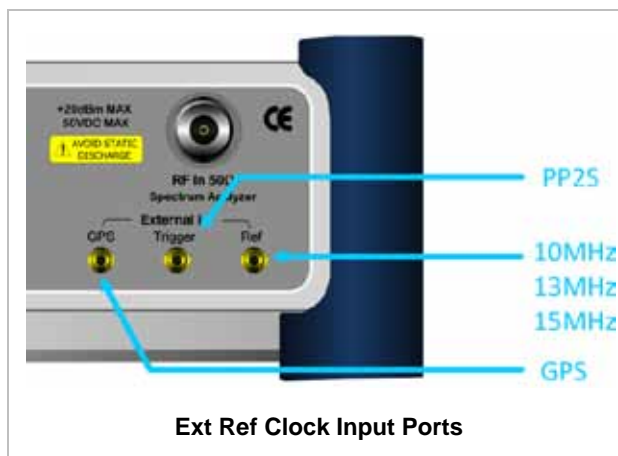

ENABLING EXTERNAL REFERENCE

| Step | Description |
|---|--|
| 1. Connect an external reference | Connect one of the external references or a GPS antenna to the JD740A series. |
| 2. Change reference clock SYSTEM [Frequency Reference] [External 10 MHz], [External 13 MHz], [External 15 MHz] or [GPS] | Press the SYSTEM hot key. Press the Frequency Reference soft key to select one of the external reference clocks or GPS. Press one of the soft keys to choose among External 10 MHz , External 13 MHz , External 15 MHz , and GPS . |

EXTERNAL REFERENCE INDICATOR INFORMATION

Each indicator tells different locking status according to a connection. When a GPS antenna is connected, longitude and latitude information will be displayed on the screen.

| Type | Indicator | Description |
|----------|--|----------------------------------|
| Internal |  (Green) | Locked |
| External |  (Green) | Locked |
| |  (Red) | Unlocked |
| GPS |  (Green) | Locked |
| |  (Yellow) | Locking in progress |
| |  (Gray) | Unable to lock or antenna failed |

Measurement Procedure

| Step | Description |
|--|---|
| 1. Set the measurement parameters MEASURE SETUP [CCDF Length] Enter a value [Enter] | Press the MEASURE SETUP hot key. Press the CCDF Length soft key. Use the numeric keys to input value. Press the Enter soft key. |

WCDMA Power Statistics CCDF Measurement Procedure

MEASURE SETUP



- n **CCDF LENGTH:** Sets the length of the CCDF which is the number of measurements to be averaged. To change the value, use the numeric keys and press the **Enter** soft key or the **ENTER** hard key to complete to the input (value range 1 to 100).

Measurement Example

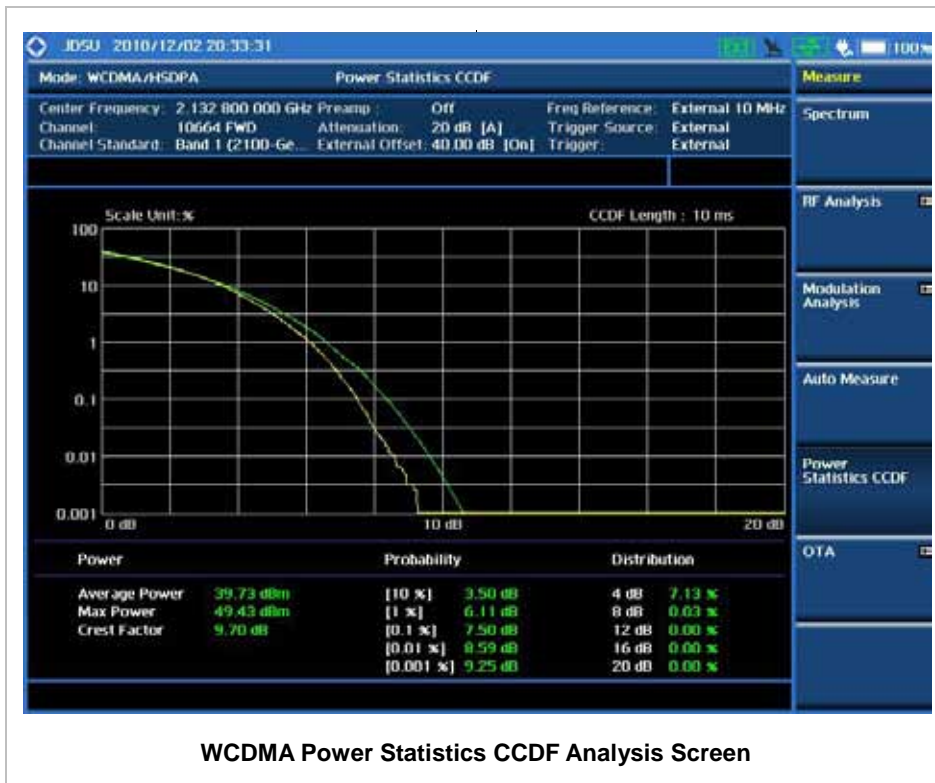

WCDMA OTA MEASUREMENTS

This Over The Air (OTA) measurement has scramble scanner, multipath profile, and Code Domain power screens. Scramble scanner displays six scrambling codes and powers to inform neighbor cells existence and its power. The multipath profile graph helps the user to determine testing area's RF environmental condition. The Code Domain power shows not only modulation performance metric but also amplifier capacity and code utilization metric. The Amplifier capacity (code utilization) measurement is an estimate of the amount of power amplifier capacity (code utilization) that is being used expressed in percent of maximum.

WCDMA/HSDPA OTA Measurements provide the following essential measurements.

- n Channel Scanner
- n Scramble Scanner
- n Multipath Profile
- n Code Domain Power
- n Route Map

Setting Mode

Connecting a GPS antenna with the instrument is a mandatory for the OTA measurements.

| Step | Description |
|---|---|
| 1. Connect the antenna | Connect antennas as shown in the section Connecting a Cable on page 8 of this chapter. |
| 2. Select the mode MODE [Signal Analyzer] [WCDMA] [OTA] [Channel Scanner], [Scramble Scanner], [Multipath Profile], [Code Domain Power], or [Route Map] | Press the MODE hard key. Press the Signal Analyzer soft key. Press the WCDMA soft key. Press the OTA soft key. Press one of the measurement mode soft keys to select. |

Setting Frequency

Setting frequency described here is not applicable to the OTA Channel Scanner mode. For the OTA Channel Scanner mode, refer to its measurement procedure.

| Step | Description |
|---|--|
| 1. Set the frequency FREQ/DIST [Unit] <Freq> or <Channel> <i>When Freq is selected:</i> [Center Frequency] Enter a value [GHz], [MHz], [kHz], or [Hz] <i>When Channel is selected:</i> [Channel Standard] Select a channel standard | Press the FREQ/DIST hard key. Press the Unit soft key. Toggle this key between Freq and Channel . A set of Freq/Dist screen menu changes accordingly. Press the Center Frequency soft key. Use the numeric keys, the rotary knob, or the arrow keys. When using the numeric keys, the input is completed by selecting one of the unit soft keys. Press the Channel Standard soft key. If this channel standard shows its default setting Band Global, go set the channel number directly. Press the arrow keys, rotate the knob, or press the Page Up and Page Down soft keys to highlight a frequency band to |

| | |
|---|--|
| <p>[Select] or ENTER</p> | <p>select. Press the Select soft key or the ENTER hard key.</p> |
| <p>[Channel Number] Enter a value [Forward]</p> | <p>Press the Channel Number soft key. Use the numeric keys to input value and press the Forward soft key to complete the input. The instrument automatically displays its corresponding center frequency value for the channel number.</p> |

FREQ/DIST



- n **UNIT:** Determines the way how to set the frequency band either with standard band or custom frequency band. Toggling this key between **Freq** and **Channel** changes a set of Freq/Dist screen menu automatically. When the **Channel** is selected, the instrument sets the **Channel Standard** setting to **Band Global** as default so that the user can set the **Channel Number** directly without choosing a standard channel band from the list.
- n **CENTER FREQUENCY:** Changes the center frequency setting. Use the rotary knob or the arrow keys. Or use the numeric keys to input a certain value and press one of the unit soft keys to complete the input.
- n **FREQUENCY STEP:** Defines the amount of frequency to be increased or decreased when using the rotary knob or the arrow keys to change the **Center Frequency**. This frequency step size can be entered by using numeric keys and the unit soft keys.
- n **CHANNEL NUMBER:** Enters a channel number. The instrument automatically displays its corresponding center frequency value for the channel number.
- n **CHANNEL STEP:** Defines the amount of channel to be increased or decreased when using the rotary knob or the arrow keys to change the **Channel Number**. This channel step size can be entered by using numeric keys and the **Enter** soft key.
- n **CHANNEL STANDARD:** When the channel standard is selected from the list, the center frequency information on the display screen will be mapped accordingly to the selected channel standard. The channel standards available in the instrument are listed in the Appendix C – Band, Frequency & Channel Standard.

Setting Amplitude

| Step | Description |
|--|---|
| <p>1. Set the reference/attenuation level AMP/SCALE</p> | <p>Press the AMP/SCALE hard key.</p> |

| | |
|--|---|
| <p>[Auto Scale]</p> <p>or</p> | <p>Press the Auto Scale soft key to automatically set optimum levels of reference and attenuation.</p> |
| <p>[Reference Level]</p> <p>Enter a reference level value</p> <p>[dBm] or ENTER</p> | <p>Press the Reference Level soft key to set manually.</p> <p>Use the numeric keys or the rotary knob that changes in a 10 dB step.</p> <p>Press the dBm soft key or the ENTER hard key.</p> |
| <p>[Attenuation]</p> <p><Manual></p> <p>Enter an attenuation value</p> | <p>Press the Attenuation soft key. The Auto mode is set by default. This key toggles between the Auto and Manual.</p> <p>Press the Attenuation soft key to highlight the Manual mode and change the attenuation value to optimize S/N.</p> <p>Use the numeric keys or the rotary knob that changes in a 5 dB step. The attenuation setting range is 0 to 50 dB.</p> |

AMP/SCALE



- n **AUTO SCALE:** The instrument can automatically set the scale to the minimum and maximum values on the Y-axis of the graph for optimum display of the traces measured. Each time the **Auto Scale** is selected, the top and bottom scales are set to the minimum and maximum values with margin on the Y-axis of the display screen.
- n **REFERENCE:** Sets the display of measurement result to relative or absolute value. Toggle between **Abs** for absolute and **Rel** for relative. *This key is used in the Code Domain Power mode and the Route Map mode.*
 - Y **ABS:** The code domain power is measured absolute to channel power.
 - Y **REL:** The code domain power is measured relative to channel power.
- n **REFERENCE LEVEL:** Sets the maximum Y-axis range. In the OTA Code Domain Power mode, this key is activated only when the **Reference** is set to absolute mode. *This key is used in the Channel Scanner mode and the Code Domain Power mode.*
- n **ATTENUATION**
 - Y **AUTO:** Input attenuator's value is automatically set depending on the reference level. This is the default operation mode, so it is recommended to use this mode unless a special measurement condition is needed.
 - Y **MANUAL:** Sets the attenuator's value for the **Spectrum Analyzer RF In 50 Ω** port.
- n **PREAMP:** Turns on or off the internal pre-amplifier. Preamp results in a correction being applied to compensate for the gain of the preamp so that amplitude readings show the value at the input connector. This soft key toggles between the **On** and **Off**. When it is set to On, the allowable attenuation input range is from 0 dB to 10 dB in a multiple of 5. If the attenuation value is manually

set greater than 10 dB, the instrument will automatically turn off the pre-amplifier to display low level signal properly on the screen.

- n **UNITS:** Sets the scale unit on the display among **dBm**, **dBV**, **dBmV**, **dBuV**, **V**, and **W**.
- n **EXTERNAL OFFSET:** Sets an external offset value. An offset consists of a cable loss and a user offset and the measurement result shows the value reflecting both offset values. When the external offset value is set at 40 dB in the Spectrum mode, the measurement result compensates 40 dB at both the Spectrum Analyzer and Signal Analyzer modes.

Setting Sweep Mode

SWEEP



This hot key is used to set the sweep parameters. The user input window must be inactive first to get the Sweep hot key function other than the number input.

- n **SWEEP MODE:** Sets the sweep method. Toggle between **Continue** and **Single**.

| Step | Description |
|--|---|
| 1. Set the sweep mode SWEEP [Sweep Mode] | Press the SWEEP hot key. Press the Sweep Mode soft key. Toggle between Continue and Single . |

Setting Trigger Source

TRIGGER



This hot key is used to select the trigger source among **Internal**, **External**, and **GPS**. The user input window must be inactive first to get the Trigger hot key function other than the number input. For OTA measurement, a GPS antenna should be connected and the trigger source should be set to **GPS**.

Setting External Clock

To enhance the reliability of modulation analysis measurements the JD740A series must be synchronized with the Base Station. When an external clock is not supplied, the JD740A series works with a built-in internal high-accuracy time base. In this case, some measurement results may exhibit inaccurate values. Therefore, it is highly recommended to use the same reference clock as signal source. Trigger mode can be changed by using the **TRIGGER** hot key.

EXTERNAL CLOCK OPERATING STANDARDS

| Clock | Type | Reference | Port | Switching Standard |
|--------------------|----------|--------------------|---------------|--|
| External Reference | Internal | Internal 10 MHz | | Default |
| | External | External Ref Clock | Ext Ref (SMA) | Manual switching (Input signal level >-3 dBm) |
| | GPS | GPS Clock | GPS (SMA) | Automatic switching (GPS signal received) |
| Trigger | Internal | Internal Trigger | | Default |
| | External | External Trigger | Trigger (SMA) | Manual switching |
| | GPS | GPS | GPS (SMA) | Manual switching |

CONNECTION

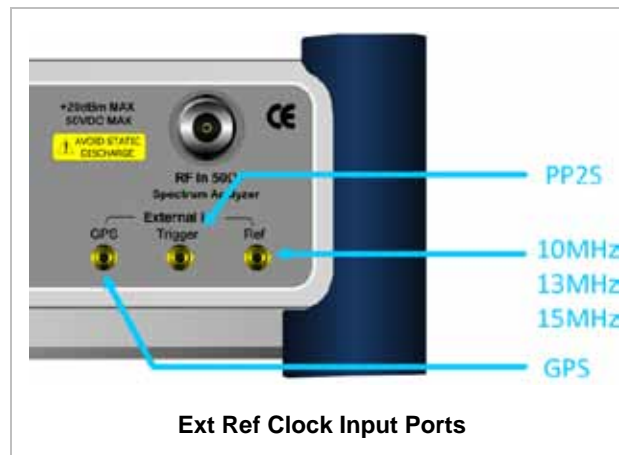



ENABLING GPS EXTERNAL REFERENCE

| Step | Description |
|--|--|
| 1. Connect a GPS antenna | Connect a GPS antenna to the JD740A series. |
| 2. Change reference clock SYSTEM [Frequency Reference] [GPS] | Press the SYSTEM hot key. Press the Frequency Reference soft key. Press the GPS soft key to perform OTA measurements. |

GPS EXTERNAL REFERENCE INDICATOR INFORMATION

When a GPS antenna is connected, the instrument automatically detects it. Each indicator tells different locking status depending on its connection. If it is successfully locked, the instrument will display "GPS" and longitude and latitude information on the screen. If it is unlocked or the antenna is

disconnected, the display will be automatically switched to "Internal".

| Type | Indicator | Description |
|------|--|----------------------------------|
| GPS |  (Green) | Locked |
| |  (Yellow) | Locking in progress |
| |  (Gray) | Unable to lock or antenna failed |

WCDMA OTA CHANNEL SCANNER

Measurement Procedure

| Step | Description |
|---|--|
| 1. Set the measurement mode MEASURE [OTA] [Channel Scanner] | Press the MEASURE hot key. Press the OTA soft key. Press the Channel Scanner soft key. |
| 2. Set the frequency FREQ/DIST [Edit List] [Add] or [Delete] | Press the FREQ/DIST hard key. Press the Edit List soft key to add, delete, or edit the list of channels to be scanned and a list of channels will pop up. Press the Add soft key to add a channel to the list. To change a channel standard, use the rotary knob to highlight the channel standard and then press the center of the rotary knob or the ENTER hard key. In the band list pop-up window, use the rotary knob or the arrow keys to highlight a channel band and then press the center of the rotary knob or the ENTER hard key. To change the channel number or frequency, use the rotary knob to highlight the channel number or the frequency and then press the center of the rotary knob or the ENTER hard key. Use numeric keys to enter a value and then press the ENTER hard key to complete the entry. In the Edit List window, use the rotary knob or the arrow keys to highlight a channel to delete and then press the |

| | |
|---|---|
| | Delete hard key. |
| <p>3. Set the averaging</p> <p>BW/AVG</p> <p>[Average]</p> <p>Enter a value</p> <p>[Enter] or ENTER</p> | <p>Press the BW/AVG hard key.</p> <p>Press the Average soft key.</p> <p>Use the numeric keys to input value between 1 and 100.</p> <p>Press the Enter soft key or the ENTER hard key.</p> |

WCDMA OTA Channel Scanner Measurement Procedure

FREQ/DIST



- n **EDIT LIST:** Adds new channel(s) to be measured or deletes or edits existing channel standard(s) in the pop-up list window.

BW/AVG



- n **AVERAGE:** Sets the number of measurements to be averaged for the trace presentation. A maximum of 100 times of averaging can be set.

Setting Limit

LIMIT



This hot key is used to set the threshold value for the limit line on the display screen. It turns on or off the limit or band limit settings of the measurement for pass/fail indication. The user input window must be inactive first to get the Limit hot key function other than the number input.

| Step | Description |
|--|---|
| <p>1. Select the limit line</p> <p>LIMIT</p> <p>[Limit Line]</p> <p><On> or <Off></p> <p>Enter a value</p> <p>[dBm] or ENTER</p> | <p>Press the LIMIT hot key.</p> <p>Press the Limit Line soft key to toggle between On and Off.</p> <p>This will enable or disable the limit line on the display screen.</p> <p>Use the numeric keys to input value.</p> <p>Press the dBm unit soft key or the ENTER hard key.</p> |

- n **LIMIT LINE:** Enables or disables the test limit. Toggle the **Limit Line** soft key between **On** and **Off**. When the display line is set to on, use the numeric keys to enter a limit value and then press the **dBm** unit soft key or the **ENTER** hard key.

Measurement Example

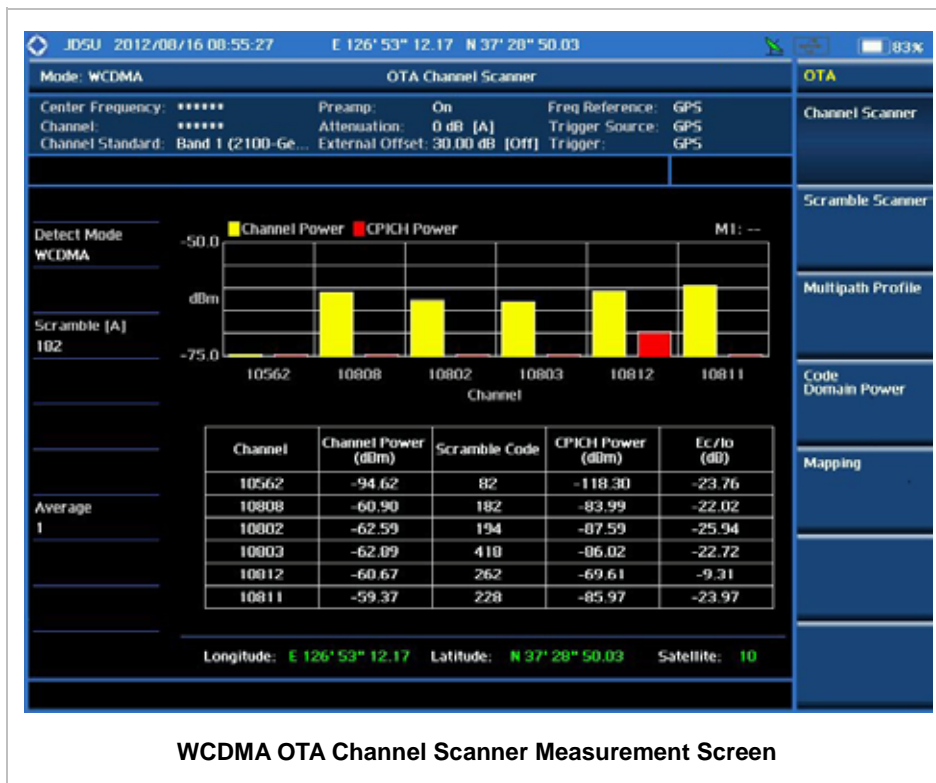

WCDMA OTA SCRAMBLE SCANNER

The WCDMA mobile receives signals from multiple base stations that all of these signals share the same spectrum and are present at the same time. Each base station has unique scrambling code assigned to the particular base station and it differentiates its signal from other base stations in the area.

Measurement Procedure

| Step | Description |
|--|--|
| 1. Set the measurement mode MEASURE [OTA] [Scramble Scanner] | Press the MEASURE hot key. Press the OTA soft key. Press the Scramble Scanner soft key. |
| 2. Set the measurement parameter MEASURE SETUP [Auto Save] | Press the MEASURE SETUP hot key. Press the Auto Save soft key. Toggle between On and |

| | |
|---------------|------|
| <On> or <Off> | Off. |
|---------------|------|

WCDMA OTA Scramble Scanner Measurement Procedure

MEASURE SETUP



- n **AUTO SAVE:** Enables or disables automatic saving of the measurement data to an external USB memory. When it turns on, the measurements will be recorded into the default file (logging.ota) or a user-named file.

Measurement Example



WCDMA OTA Scramble Scanner Measurement Screen

WCDMA OTA MULTIPATH PROFILE

The Multipath Profile enables the user to determine RF environmental conditions of testing area. It indicates the amount of power of the dominant pilot signal that is dispersed outside the main correlation peak due to multipath echoes that are expressed in dB. This value should be very small ideally.

The multipath profile is the result of portions of the original broadcast signal arriving at the receiving antenna out of phase. This can be caused by the signal being reflected off objects such as buildings, or being refracted through the atmosphere differently from the main signal.

Measurement Procedure

| Step | Description |
|---|---|
| 1. Set the measurement mode MEASURE [OTA] [Multipath Profile] | Press the MEASURE hot key. Press the OTA soft key. Press the Multipath Profile soft key. |

WCDMA OTA Multipath Profile Measurement Procedure

Measurement Example

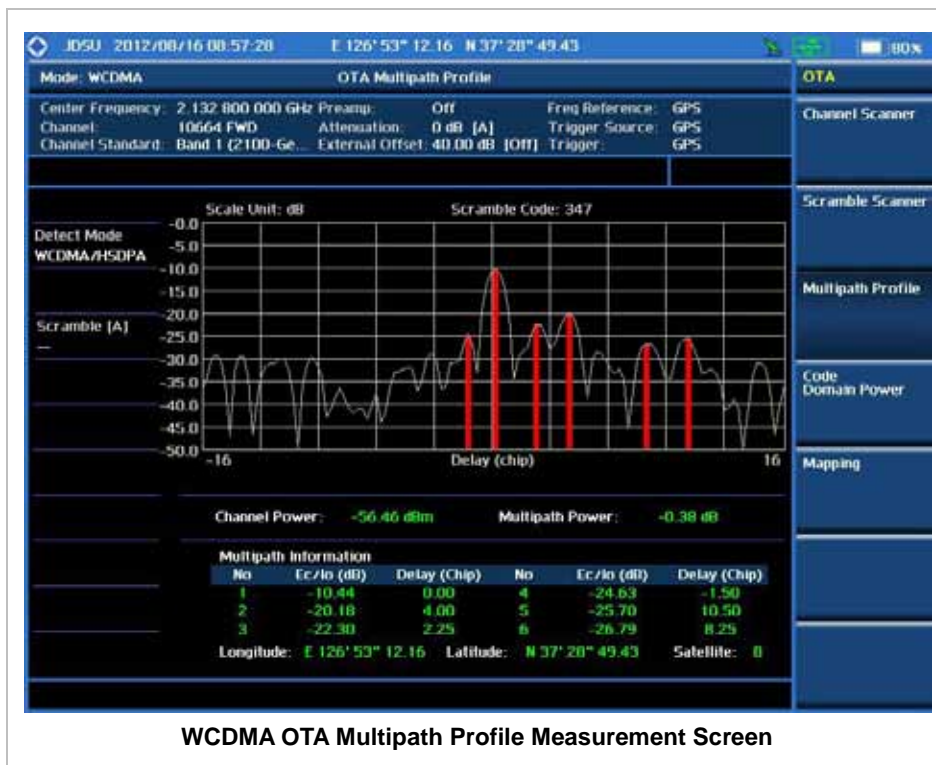

WCDMA OTA Multipath Profile Measurement Screen

WCDMA OTA CODE DOMAIN POWER

Channels with high correlation factors are determined to be active channels and are indicated as such on the display. Once the channels are decoded, the analyzer determines the power of each channel

relative to the total signal power.

This measurement helps to verify that each code channel is operating at its proper level and helps to identify problems throughout the transmitter design from the coding to the RF section. System imperfections, such as the non-linearity of amplifiers, will present themselves as an undesired distribution of power in the code domain.

Measurement Procedure

| Step | Description |
|---|---|
| 1. Set the measurement mode MEASURE [OTA] [Code Domain Power] | Press the MEASURE hot key. Press the OTA soft key. Press the Code Domain Power soft key. |
| 2. Set the measurement parameters MEASURE SETUP [Scramble] <Auto> or <Manual> Enter a value [Enter] or ENTER [Detect Mode] <HSDPA> , <WCDMA> or <HSDPA+> [Threshold] Enter a value [dB] or ENTER [S-CCPCH] [S-CCPCH] <On> or <Off> [Spread Factor] [4] , [8] , [16] , [32] , [64] , [128] , or [256] [Channel Number] Enter a value [Enter] or ENTER [PICH] [PICH] <On> or <Off> | Press the MEASURE SETUP hot key. Press the Scramble soft key. Toggle between Auto and Manual . Use the numeric keys to input value between 0 and 511. Press the Enter soft key or the ENTER hard key. Press the Detect Mode soft key. Each time this soft key is pressed, the selection changes. Press the Threshold soft key. Use the numeric keys to input value between -50 and 0. Press the unit soft key or the ENTER hard key. Press the S-CCPCH soft key. Press the S-CCPCH soft key in the S-CCPCH menu bar. Toggle this soft key between On and Off . Press the Spread Factor soft key. Press one of the spread factor soft keys to select. Press the Channel Number soft key. Use the numeric keys to input value. Press the Enter soft key or the ENTER hard key. Press the PICH soft key. Press the PICH soft key in the PICH menu bar. Toggle this soft key between On and Off . |

| | |
|---|---|
| <p>[Spread Factor] [4], [8], [16], [32], [64], [128], or [256]</p> | <p>Press the Spread Factor soft key. Press one of the spread factor soft keys to select.</p> |
| <p>[Channel Number] Enter a value [Enter] or ENTER</p> | <p>Press the Channel Number soft key. Use the numeric keys to input value. Press the Enter soft key or the ENTER hard key.</p> |
| <p>[Max Amplifier Power] Enter a value [dBm] or ENTER</p> | <p>Press the Max Amplifier Power soft key. Use the numeric keys to input value. Press the unit soft key or the ENTER hard key.</p> |
| <p>[More (1/2)]</p> | <p>Press the More (1/2) soft key to get more soft keys.</p> |
| <p>[CPICH Power] Enter a value [dBm] or ENTER</p> | <p>Press the CPICH Power soft key. Use the numeric keys to input value. Press the unit soft key or the ENTER hard key.</p> |
| <p>[CPICH Dominance >] Enter a value [dBm] or ENTER</p> | <p>Press the CPICH Dominance > soft key. Use the numeric keys to input value. Press the unit soft key or the ENTER hard key.</p> |
| <p>[Multipath Power <] Enter a value [dBm] or ENTER</p> | <p>Press the Multipath Power < soft key. Use the numeric keys to input value. Press the unit soft key or the ENTER hard key.</p> |
| <p>[Auto Save] <On> or <Off></p> | <p>Press the Auto Save soft key. Toggle between On and Off.</p> |

WCDMA OTA Code Domain Measurement Procedure

MEASURE SETUP



- n **SCRAMBLE:** Sets the scramble code to **Auto** or **Manual**. Toggle between **Auto** and **Manual**. To change the value in the **Manual** mode, use the numeric keys to enter a value between 0 and 511 and press the **Enter** soft key or the **ENTER** hard key to complete to the input.
- n **DETECT MODE:** Selects the signal standard of **HSDPA**, **WCDMA** or **HSDPA+**. Default setting is **HSDPA**. Each time this soft key is pressed, the selection changes.
- n **TRHESHOLD:** Sets the threshold value. Default setting is -27 dB. Use the numeric keys to enter a value between -50 and 0 and then press the unit soft key or the **ENTER** hard key to complete to the input.
- n **S-CCPCH:** Sets S-CCPCH information of the system to be tested.
- Y **S-CCPCH:** Enables or disables the S-CCPCH. Toggle between **On** and **Off**.

- Y **SPREAD FACTOR:** Selects the spreading factor among **4, 8, 16, 32, 64, 128,** and **256.**
- Y **CHANNEL NUMBER:** Sets the channel number. Use the numeric keys to enter a value and press the **Enter** soft key or the **ENTER** hard key to complete to the input.
- n **PICH:** Sets PICH information of the system to be tested.
 - Y **PICH:** Enables or disables the PICH. Toggle between **On** and **Off.**
 - Y **SPREAD FACTOR:** Selects the spreading factor among **4, 8, 16, 32, 64, 128,** and **256.**
 - Y **CHANNEL NUMBER:** Sets the channel number. Use the numeric keys to enter a value and press the **Enter** soft key or the **ENTER** hard key to complete to the input.
- n **MAX AMPLIFIER POWER:** Sets the maximum amp power. Press this soft key and rotate the knob or press the arrow keys to enter a value. Or use the numeric keys and press the **dBm** unit soft key to complete the input.
- n **CPICH POWER:** Sets the CPICH power. Press this soft key and rotate the knob or press the arrow keys to enter a value. Or use the numeric keys and press the **dBm** unit soft key to complete the input.
- n **CPICH DOMINANCE >:** Sets the threshold for CPICH dominance. 10 is recommended. Color of the CPICH Dominance indicator on the left bottom corner of the screen is based on this set value.
- n **MULTIPATH POWER <:** Sets the threshold for multipath power. 1 is recommended. Color of the Multipath Power indicator on the left bottom corner of the screen is based on this set value.
- n **AUTO SAVE:** Enables or disables automatic saving of the measurement data to an external USB memory. When it turns on, the measurements will be recorded into the default file (logging.ota) or a user-named file.

Setting Limit



This hot key is used to set the threshold value for the limit line on the display screen. It turns on or off the limit or band limit settings of the measurement for pass/fail indication. The user input window must be inactive first to get the Limit hot key function other than the number input.

| Step | Description |
|---|---|
| 1. Select the limit LIMIT [Modulation Test Limits] [Frequency Error] [Test Limits] | Press the LIMIT hot key. Press the Modulation Test Limits soft key. Press the Frequency Error soft key. Press the Test Limits soft key. Toggle between On and |

| | |
|---|---|
| <p><On> or <Off> [High Limit] [Low Limit]</p> <p>[EVM] [Test Limit] <On> or <Off> [High Limit]</p> <p>[PCDE] [Test Limit] <On> or <Off> [High Limit]</p> <p>[Carrier Feed Through] [Test Limit] <On> or <Off> [High Limit]</p> <p>[CPICH] [Test Limits] <On> or <Off> [High Limit (Abs)] [Low Limit (Abs)] or [High Limit (Rel)] [Low Limit (Rel)]</p> <p>[Max Inactive] [Test Limit] <On> or <Off> [High Limit]</p> | <p>Off. Use the numeric keys and input a number in ppm. Use the numeric keys and input a number in ppm.</p> <p>Press the EVM soft key. Press the Test Limit soft key. Toggle between On and Off. Use the numeric keys and input a number in %.</p> <p>Press the PCDE soft key. Press the Test Limit soft key. Toggle between On and Off. Use the numeric keys and input a number in dB.</p> <p>Press the Carrier Feed Through soft key. Press the Test Limit soft key. Toggle between On and Off. Use the numeric keys and input a number in dB.</p> <p>Press the CPICH soft key. Press the Test Limits soft key. Toggle between On and Off. Use the numeric keys and input a number in dBm. Use the numeric keys and input a number in dBm.</p> <p>Use the numeric keys and input a number in dB. Use the numeric keys and input a number in dB.</p> <p>Press the Max Inactive soft key. Press the Test Limit soft key. Toggle between On and Off. Use the numeric keys and input a number in dB.</p> |
| <p>2. Enable beep LIMIT [Beep] <On> or <Off></p> | <p>Press the LIMIT hot key. Press the Beep soft key to toggle between On and Off and select one. This will make audible alarm if the measurement result goes beyond the limit.</p> |

- n **FREQUENCY ERROR:** Sets the frequency error limit.
- Y **TEST LIMITS:** Enables or disables the test limit(s). Toggle the **Test Limits** soft key between **On** and **Off**.
- Y **HIGH LIMIT:** Sets the upper limit. Use the numeric keys to input value and press the unit soft key or the **ENTER** hard key to complete the input.

- **LOW LIMIT:** Sets the lower limit. Use the numeric keys to input value and press the unit soft key or the **ENTER** hard key to complete the input.
- n **EVM:** Sets the error vector magnitude limit.
 - **TEST LIMIT:** Enables or disables the test limit(s). Toggle the **Test Limit** soft key between **On** and **Off**.
 - **HIGH LIMIT:** Sets the upper limit. Use the numeric keys to input value and press the unit soft key or the **ENTER** hard key to complete the input.
- n **PCDE:** Sets the peak code domain error limit.
 - **TEST LIMIT:** Enables or disables the test limit(s). Toggle the **Test Limit** soft key between **On** and **Off**.
 - **HIGH LIMIT:** Sets the upper limit. Use the numeric keys to input value and press the unit soft key or the **ENTER** hard key to complete the input.
- n **CARRIER FEED THROUGH:** Is a result of the RF carrier signal feeding through the I/Q modulator and riding on the output circuitry without being modulated. Sets the limit of carrier feed through.
 - **TEST LIMIT:** Enables or disables the test limit(s). Toggle the **Test Limit** soft key between **On** and **Off**.
 - **HIGH LIMIT:** Sets the upper limit. Use the numeric keys to input value and press the unit soft key or the **ENTER** hard key to complete the input.
- n **CPICH:** Sets the CPICH power limit.
 - **TEST LIMITS:** Enables or disables the test limit(s). Toggle the **Test Limits** soft key between **On** and **Off**.
 - **HIGH LIMIT (ABS):** Sets the upper limit. Use the numeric keys to input value and press the unit soft key or the **ENTER** hard key to complete the input.
 - **LOW LIMIT (ABS):** Sets the lower limit. Use the numeric keys to input value and press the unit soft key or the **ENTER** hard key to complete the input.
 - **HIGH LIMIT (REL):** Sets the upper limit. Use the numeric keys to input value and press the unit soft key or the **ENTER** hard key to complete the input.
 - **LOW LIMIT (REL):** Sets the lower limit. Use the numeric keys to input value and press the unit soft key or the **ENTER** hard key to complete the input.
- n **MAX INACTIVE:** Sets the limit of the highest level among inactive channels.
 - **TEST LIMIT:** Enables or disables the test limit. Toggle the **Test Limit** soft key between **On** and **Off**.
 - **HIGH LIMIT:** Sets the upper limit. Use the numeric keys to input value and press the unit soft key or the **ENTER** hard key to complete the input.

Measurement Example

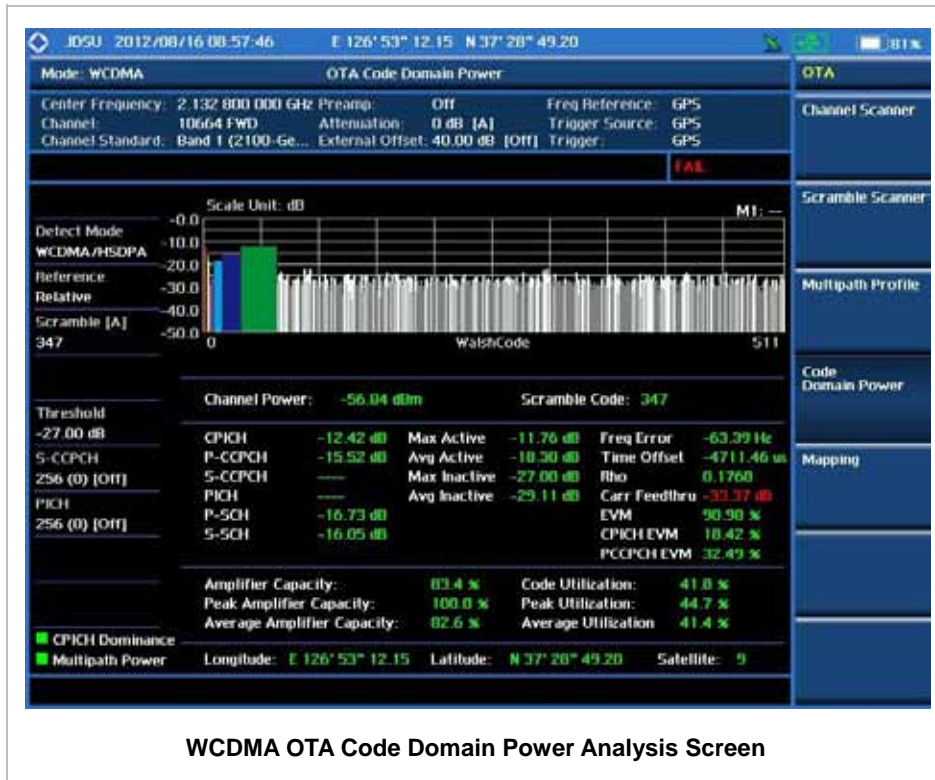

WCDMA OTA Code Domain Power Analysis Screen

WCDMA ROUTE MAP

The JD740A Series provides indoor and outdoor mapping function that allows a user to collect data of points in an indoor or outdoor environment and track the received signals and coverage of RF transmitters plotting real time directly on top of a loaded floor plan or a map.

Measurement Procedure

| Step | Description |
|---|---|
| 1. Set the measurement mode MEASURE [OTA] [Route Map] | Press the MEASURE hot key. Press the OTA soft key. Press the Route Map soft key. |
| 2. Set the measurement parameters MEASURE SETUP | Press the MEASURE SETUP hot key. |

| | |
|---|--|
| <p>[Load Map]</p> | <p>After plugging in a USB drive, press the Load Map soft key to load a map file created in JMapCreator and copied into the USB drive.</p> |
| <p>[Plot Point] [Position] or [GPS]</p> | <p>Press the Plot Point soft key to get option menu. Press the Position soft key without a GPS antenna or the GPS with one. Selecting GPS activates the Screen Mode soft key to be set.</p> |
| <p>[Plot Item] [CPICH Power] or [Ec/Io]</p> | <p>Press the Plot Item soft key. Select either CPICH Power or Ec/Io as needed.</p> |
| <p>[Screen Mode] <Map> or <Full></p> | <p>Press the Screen Mode soft key. Toggle this key between Map and Full.</p> |
| <p>[Plot] <Start> or <Stop></p> | <p>Press the Plot soft key to start or stop plotting. Toggle this key between Start and Stop.</p> |

MEASURE SETUP



Sets the measurement parameters for the Route Map. The legend displayed in different colors at the bottom of the screen can be set with the **Limit** hot key.

- n **PLOT:** Starts or stops a measurement in order to plot received signals or collected data on top of a loaded map. Toggle this key between **Start** and **Stop**. The instrument does not automatically save collected data. After stopping the current route mapping, the user needs to save the result with the **Save** hot key for later use. If not, all the collected data for the route will be lost.
- n **PLOT POINT:** Selects a method of plotting points.
- Y **POSITION:** Measures data without GPS in an indoor environment. After starting to plot, press the **Enter** hard key or the center of the rotary knob as you move with the instrument. Each time the user presses the key or the knob, the instrument plots a point on top of the loaded map. Use the arrow keys to change direction of route and the rotary knob to change distance. If the instrument has the screen with touch screen, directly touch the screen in order to collect data.
- Y **GPS:** Automatically collects data with GPS in an outdoor environment and plots points as the user moves in a vehicle.
- n **PLOT ITEM:** Selects either **CPICH Power** or **Ec/Io**. The instrument collects the strongest scramble data from its Scramble Scanner and plots them.
- n **SCREEN MODE:** Selects either **Map** or **Full**, depending on how to show collected points on the screen. Selecting GPS for the Plot Point activates this key. Numbers shown next to the points

represent their scramble codes. The instrument displays scramble code of the start point and those of the points with different scramble codes from the right previous ones.

Y **MAP:** Displays collected points only that can be seen within the boundary of the loaded map. If a point is off the map, the instrument displays an arrow indicating the direction of the current location on the map and the distance from the center to the location at the top of the screen.

Y **FULL:** Displays all the measured points for the route on the screen without the map.

n **LOAD MAP:** Loads a floor plan or a map file created in **JDMapCreator**. The JDMapCreator converts and resizes any scanned floor plan or layout so that it can be loaded and fit to the instrument display.

Setting Limit



This hot key is used to set threshold values for the legend displayed on the screen. The different colors of the legend indicate the quality of the measured data depending on their threshold setting. The user input window must be inactive first to get the Limit hot key function other than the number input.

| Step | Description |
|----------------------|---|
| 1. Set the limit | |
| Limit | Press the LIMIT hot key. |
| [CPICH Power] | Press the CPICH Power soft key to set its threshold. |
| [Excellent] | Press the Excellent soft key. |
| Enter a value | Use the rotary knob or the numeric keys. |
| [Enter] | Press the Enter soft key. |
| [Very Good] | Press the Very Good soft key. |
| Enter a value | Use the rotary knob or the numeric keys. |
| [Enter] | Press the Enter soft key. |
| [Good] | Press the Good soft key. |
| Enter a value | Use the rotary knob or the numeric keys. |
| [Enter] | Press the Enter soft key. |
| [Fair] | Press the Fair soft key. |
| Enter a value | Use the rotary knob or the numeric keys. |
| [Enter] | Press the Enter soft key. |
| [Poor] | Press the Poor soft key. |
| Enter a value | Use the rotary knob or the numeric keys. |
| [Enter] | Press the Enter soft key. |
| [Ec/Io] | Press the Ec/Io soft key to set its threshold. |

| | |
|---|---|
| <p>[Good] Enter a value [Enter]</p> <p>[Fair] Enter a value [Enter]</p> <p>[Poor] Enter a value [Enter]</p> | <p>Press the Good soft key. Use the rotary knob or the numeric keys.</p> <p>Press the Enter soft key.</p> <p>Press the Fair soft key. Use the rotary knob or the numeric keys.</p> <p>Press the Enter soft key.</p> <p>Press the Poor soft key. Use the rotary knob or the numeric keys.</p> <p>Press the Enter soft key.</p> |
|---|---|

Measurement Example



Route Map Measurement Screen (Map View)

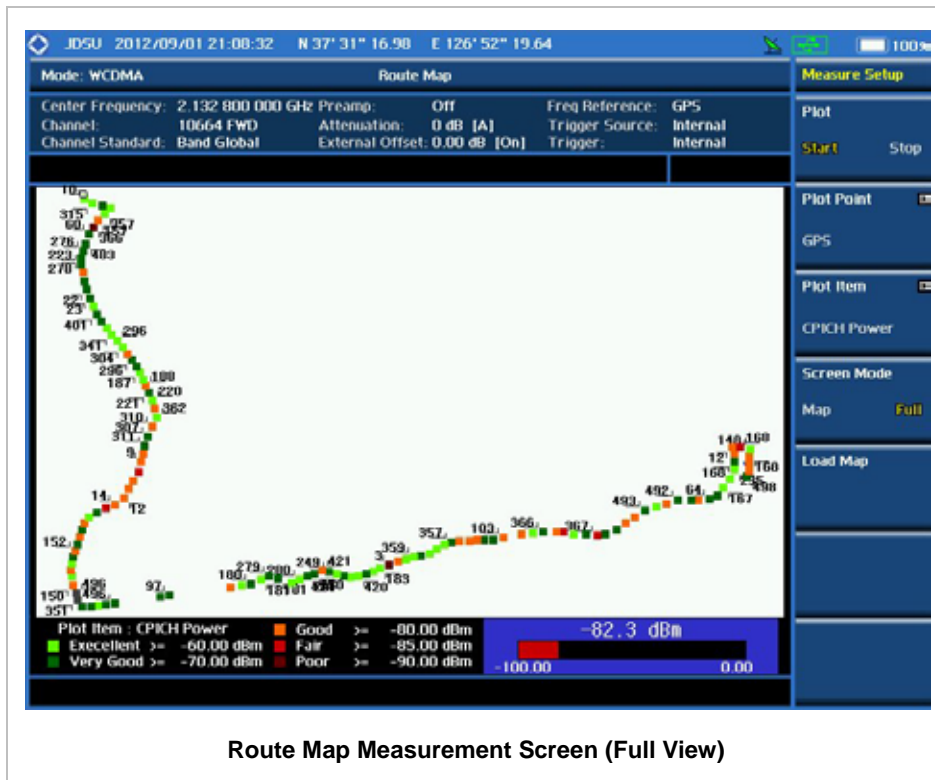

Route Map Measurement Screen (Full View)

ANALYSIS

Using Marker

MARKER



Marker is used to get the information about a specific trace. Six markers can be set on the display and each marker can be used independently. The X and Y coordinates of the trace are displayed when the marker is placed on any position of the trace. The position displaying the marker's X and Y coordinates may be slightly different for each measurement mode and refer to the description of each measurement. There are three different marker types available: Normal, Delta, and Delta pair. Marker position can be set manually by entering numeric values (frequency) when one of the marker types is selected.

- n **SELECT MARKER:** Selects an active marker whose position can be changed with the rotary knob or the arrow keys. The assigned number of the active marker is displayed in the **Select Marker** menu box and the active marker number is also displayed right next to the active marker on the trace when the **Marker View** is set to **On**.
- n **MARKER VIEW:** Displays the selected marker on the screen or hides it. When the **Marker View**

is turned off and then on again in the same measurement mode, markers appear at the previous positions. If a measurement mode is changed, markers are not restored to their previous positions.

- n **NORMAL:** This Normal marker type provides the reading of a marker position on the trace along with the marker number between 1 and 6.
- n **DELTA:** This Delta marker type is associated with a Normal marker. A Normal marker must be set before a Delta marker is set. When the Delta marker is set, the position set by the Delta marker becomes the reference position of the Normal marker and the marker's X and Y values displays the difference compared with the Delta marker.
- n **DELTA PAIR:** This Delta Pair marker type is associated with a Normal marker. A Normal marker must be set before a Delta Pair marker is set. When the Delta Pair marker is set, the position set by the Delta Pair marker becomes the reference position of the Normal marker and the marker's X and Y values displays the difference compared with the Delta Pair marker. The reference position will be varied in accordance with trace change.
- n **MARKER ALL OFF:** Turns all the markers the screen off. When the Marker View is selected for those markers, the instrument displays those markers back at the previous position. If a measurement mode is changed, current settings are not restored.
- n **MARKERà :** Sets the X coordinate of the active marker as selected.
 - ÿ **MARKERà CENTER:** Sets the frequency of the active marker to the center frequency of spectrum analyzer.
 - ÿ **MARKERà START:** Sets the frequency of the active marker to the start frequency of spectrum analyzer.
 - ÿ **MARKERà STOP:** Sets the frequency of the active marker to the stop frequency of spectrum analyzer.

Using Peak Search

PEAK SEARCH

Each time the Peak Search soft key is pressed, the active marker is positioned at the highest peak of the trace.

- n **PEAK SEARCH:** Moves the active marker to the highest peak of the trace.
- n **NEXT PEAK:** Moves the active marker to the second highest peak of the trace.
- n **NEXT PEAK RIGHT:** Moves the active marker to the highest peak to the right of its current position.
- n **NEXT PEAK LEFT:** Moves the active marker to the highest peak to the left of its current position.

- n **MIN SEARCH:** Moves the active marker to the lowest peak of the trace.
- n **ALWAYS PEAK:** When the **Always Peak** is set to On, the instrument moves the active marker automatically to the highest peak of the trace every time the trace is refreshed.

TD-SCDMA Signal Analyzer

This TD-SCDMA Signal Analyzer function is optional that the JD740AA series offers as the Option 025. It allows the user to test TD-SCDMA/HSDPA systems. The TD-SCDMA OTA Analyzer which is the Option 045 can be added to the TD-SCDMA Signal Analyzer for Over The Air measurement.

In this Chapter

| | |
|-------------------------------------|----|
| Using TD-SCDMA Signal Analyzer..... | 4 |
| Display Overview..... | 5 |
| Connecting a Cable..... | 7 |
| Direct Connection..... | 7 |
| Indirect Connection..... | 7 |
| Over The Air (OTA)..... | 8 |
| Spectrum Analysis Measurement..... | 9 |
| Setting Mode..... | 9 |
| Setting Frequency..... | 9 |
| Setting Amplitude..... | 10 |
| Setting Averaging..... | 12 |
| Setting Sweep Mode..... | 12 |
| Setting Trigger Source..... | 12 |
| Setting External Clock..... | 13 |
| Setting Trace and Display..... | 14 |
| Measurement Procedure..... | 15 |
| Measurement Example..... | 15 |
| RF Analysis Measurements..... | 16 |
| Setting Mode..... | 16 |
| Setting Frequency..... | 17 |
| Setting Amplitude..... | 18 |
| Setting Averaging..... | 19 |
| Setting Sweep Mode..... | 20 |
| Setting Trigger Source..... | 20 |
| Setting External Clock..... | 20 |
| Channel Power..... | 22 |
| Measurement Procedure..... | 22 |
| Setting Limit..... | 23 |
| Measurement Example..... | 24 |
| Occupied Bandwidth..... | 24 |
| Measurement Procedure..... | 24 |
| Setting Limit..... | 25 |
| Measurement Example..... | 26 |
| Spectrum Emission Mask (SEM)..... | 26 |
| Measurement Procedure..... | 27 |

| | |
|---|----|
| Setting Limit | 27 |
| Measurement Example | 28 |
| ACLR | 28 |
| Measurement Procedure | 28 |
| Setting Limit | 29 |
| Measurement Example | 30 |
| Multi-ACLR | 30 |
| Measurement Procedure | 30 |
| Setting Limit | 32 |
| Measurement Example | 32 |
| Spurious Emissions | 33 |
| Measurement Procedure | 33 |
| Setting Limit | 35 |
| Measurement Example | 36 |
| Power vs Time Analysis Measurements | 36 |
| Setting Mode | 37 |
| Setting Frequency | 37 |
| Setting Amplitude | 38 |
| Setting Sweep Mode | 40 |
| Setting External Clock | 40 |
| Power vs Time (Slot) | 42 |
| Measurement Procedure | 42 |
| Setting Limit | 43 |
| Measurement Example | 45 |
| Power vs Time (Frame) | 46 |
| Measurement Procedure | 46 |
| Setting Limit | 47 |
| Measurement Example | 49 |
| Power vs Time (Mask) | 50 |
| Measurement Procedure | 50 |
| Setting Limit | 51 |
| Measurement Example | 53 |
| Timogram | 53 |
| Measurement Procedure | 53 |
| Measurement Example | 55 |
| Modulation Analysis Measurements | 56 |
| Setting Mode | 56 |
| Setting Frequency | 56 |
| Setting Amplitude | 58 |
| Setting Sweep Mode | 59 |
| Setting External Clock | 59 |
| Constellation | 61 |
| Measurement Procedure | 61 |
| Setting Limit | 63 |
| Measurement Example | 64 |
| Midamble Power | 65 |
| Measurement Procedure | 65 |
| Measurement Example | 66 |
| Code Power | 67 |
| Measurement Procedure | 67 |
| Setting Limit | 68 |
| Measurement Example | 69 |
| Code Error | 70 |

| | |
|--|----|
| Measurement Procedure | 70 |
| Setting Limit | 71 |
| Measurement Example | 72 |
| Auto Measurement | 72 |
| Setting Mode | 73 |
| Setting Frequency | 73 |
| Setting Limit | 74 |
| Measurement Procedure | 76 |
| Setting Display | 78 |
| TD-SCDMA OTA Measurements | 79 |
| Setting Mode | 79 |
| Setting Frequency | 80 |
| Setting Amplitude | 81 |
| Setting Sweep Mode | 82 |
| Setting Trigger Source | 83 |
| Setting External Clock..... | 83 |
| TD-SCDMA OTA Sync-DL ID Scanner | 84 |
| Measurement Procedure | 84 |
| Measurement Example | 85 |
| TD-SCDMA OTA Sync-DL ID vs Tau | 86 |
| Measurement Procedure | 86 |
| Setting Display | 86 |
| Measurement Example | 87 |
| TD-SCDMA OTA Sync-DL ID Multipath..... | 87 |
| Measurement Procedure | 87 |
| Setting Display | 88 |
| Measurement Example | 88 |
| TD-SCDMA OTA Sync-DL ID Analyzer..... | 88 |
| Measurement Procedure | 88 |
| Measurement Example | 89 |
| TD-SCDMA Route Map | 90 |
| Measurement Procedure | 90 |
| Setting Limit | 92 |
| Measurement Example | 92 |
| Analysis | 93 |
| Using Marker..... | 94 |
| Using Peak Search | 95 |

(Rev. 6.0)

USING TD-SCDMA SIGNAL ANALYZER

The Time Division-Synchronous Code Division Multiple Access, also known as TD-SCDMA, is a 3G mobile telecommunications standard that is pursued by the Chinese Academy of Telecommunications Technology (CATT) in the People's Republic of China. The TD-SCDMA uses the TDD scheme while the WCDMA uses the FDD.

This TD-SCDMA Signal Analyzer can be used for testing of TD-SCDMA/HSDPA systems, made according to the following standard documentation.

- n 3GPP TS 25.105 Base Station radio transmission and reception (TDD)
- n 3GPP TS 25.142 Base Station conformance testing (TDD)
- n 3GPP TS 25.222 Multiplexing and channel coding (TDD)
- n 3GPP TS 25.223 Spreading and modulation (TDD)

The instrument automatically makes standard defined measurements using the measurement methods and limits as defined in the standard. The detailed results allow the user to analyze TD-SCDMA/HSDPA system performance. The user may alter the measurement parameters for specialized analysis. Pass/Fail testing with standard defined or user defined upper and lower limits and the Pass/Fail indicator help the user to determine base station performance easily.

The JD740AA series provides the following analysis tools for TD-SCDMA system.

- n Spectrum Analysis
- n RF Analysis
 - Y Channel Power
 - Y Occupied Bandwidth
 - Y Spectrum Emission Mask
 - Y Adjacent Channel Leakage Power Ratio (ACLR)
 - Y Multi-ACLR
 - Y Spurious Emissions
- n Power vs Time
 - Y Power vs Time (Slot)
 - Y Power vs Time (Frame)

- Y Power vs Time (Mask)
- Y Timogram
- n Modulation Analysis
 - Y Constellation
 - Y Midamble Power
 - Y Code Power
 - Y Code Error
- n Auto Measure
- n Over The Air (OTA)
 - Y Sync-DL ID Scanner
 - Y Sync-DL ID vs Tau
 - Y Sync-DL ID Multipath
 - Y Sync-DL ID Analyzer
 - Y Route Map

DISPLAY OVERVIEW

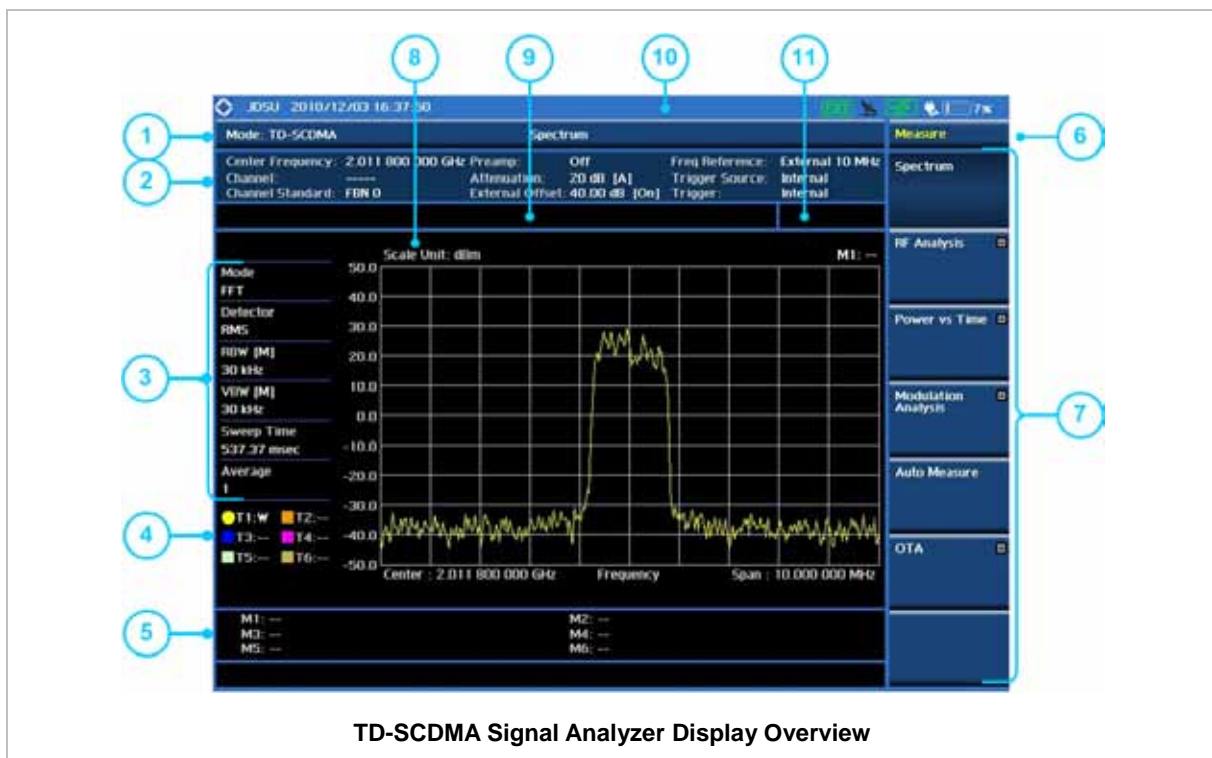

Measurement Mode Information: TD-SCDMA Signal Analyzer

Spectrum Input Level Setting Information: This window shows the most common settings or parameters of each measurement.

- Frequency and Channel Setting
- Amplitude Setting (Preamp, Attenuation, External Offset)
- Reference Setting (Frequency, Trigger)

Measurement Setting Information

- Spectrum Analyzer Operation Mode Information
- Detector Type Setting Information
- Spectrum Setting Information (RBW, VBW)
[A]: Auto mode, [M]: Manual mode
- Sweep Time Information: Displays current sweep time
- Average Number Information set through BW/AVG hard key. It shows the number of traces to be averaged.

Trace Information

- C: Captured
- M: Max Hold
- m: Min Hold
- W: Write Current Trace (Indicates current active trace)
- L: Loaded
- F: Trace View Off

Information on Marker Table displays up to 6 markers

Screen Menu Title

Screen Menu and Sub-menu

Scale Unit Information: dBm, dBV, dBmV, dBuV, V, and W

User Input Window: Activates when user input menu or key is selected. Pressing ESC hard key will cancel or deactivate user input window. Inactivate user input window before using hot keys.

NOTE: It is very important to inactivate the user input window when you intend to use the hot key menu on the numeric keys.

System Information

- Date and Time
- Positioning Information (Longitude and Latitude). It is available only when a GPS antenna is connected. Frequency reference is automatically set to GPS in the System menu when a GPS antenna is connected.
- Frequency Reference Indicator: INT for internal and EXT for external. The EXT icon is green when an external reference is locked or red when the external reference is not locked. When a GPS antenna is connected, this space will be blank.
- GPS Indicator: Color of the GPS icon changes among green, yellow and gray depending on locking status.

- USB Indicator
 - DC Input Power Indicator
 - Battery Indicator
- Pass/Fail Indicator

CONNECTING A CABLE

Direct Connection

Connect the **Spectrum Analyzer RF In 50 Ω** port of the JD740AA series and the PA output port of BTS.

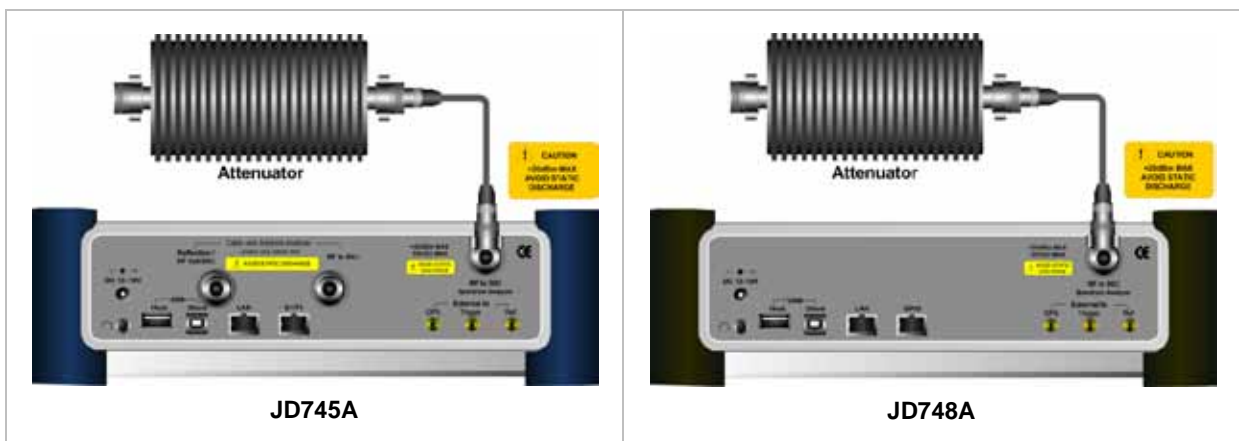

Indirect Connection

Connect the **Spectrum Analyzer RF In 50 Ω** port of the JD740AA series and the monitor port of BTS.

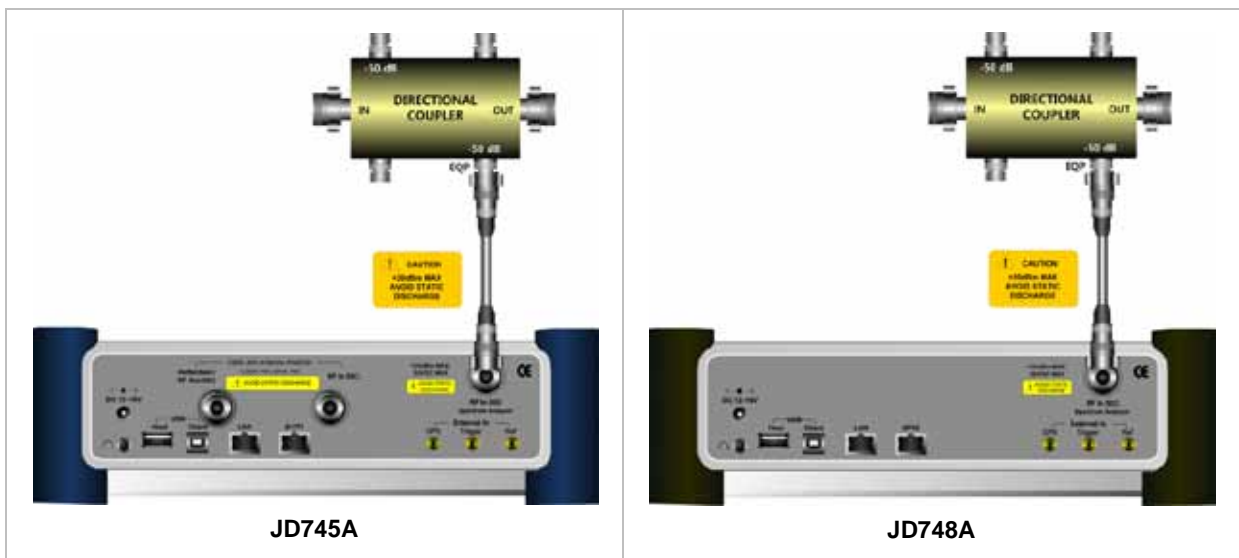



The maximum power for the **Spectrum Analyzer RF In 50 Ω** port is +20 dBm (0.1 Watt). If the input signal level to be measured is greater than +20 dBm, use a **High Power Attenuator** to prevent damage when you directly connect the signal to the instrument. Or connect a signal from the coupling port of a directional coupler.

Over The Air (OTA)

Connect an Omni/directional RF antenna to the **Spectrum Analyzer RF In 50 Ω** port of the JD740AA series and then a GPS antenna to the **GPS** port of the JD740AA series.

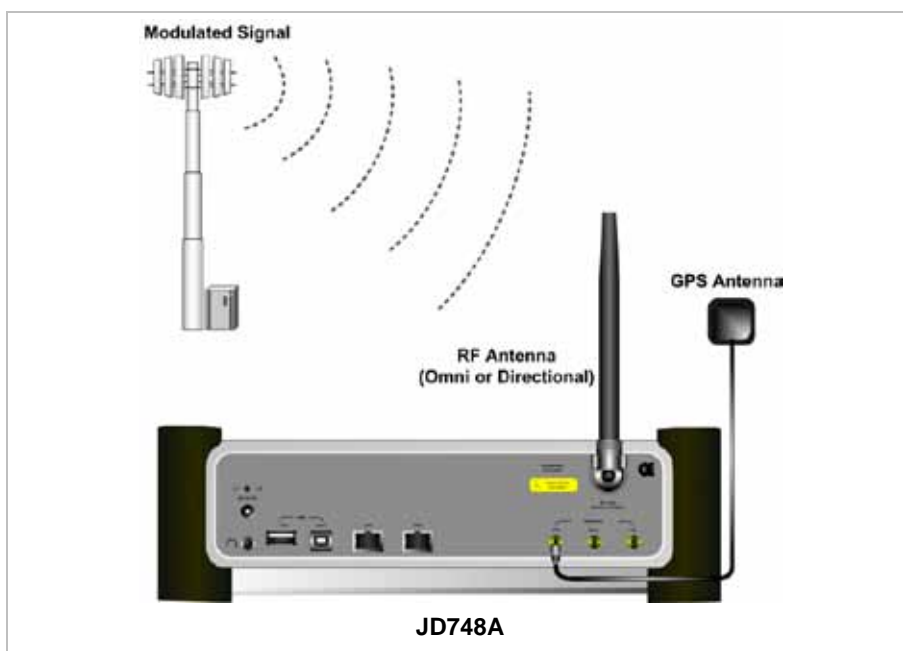
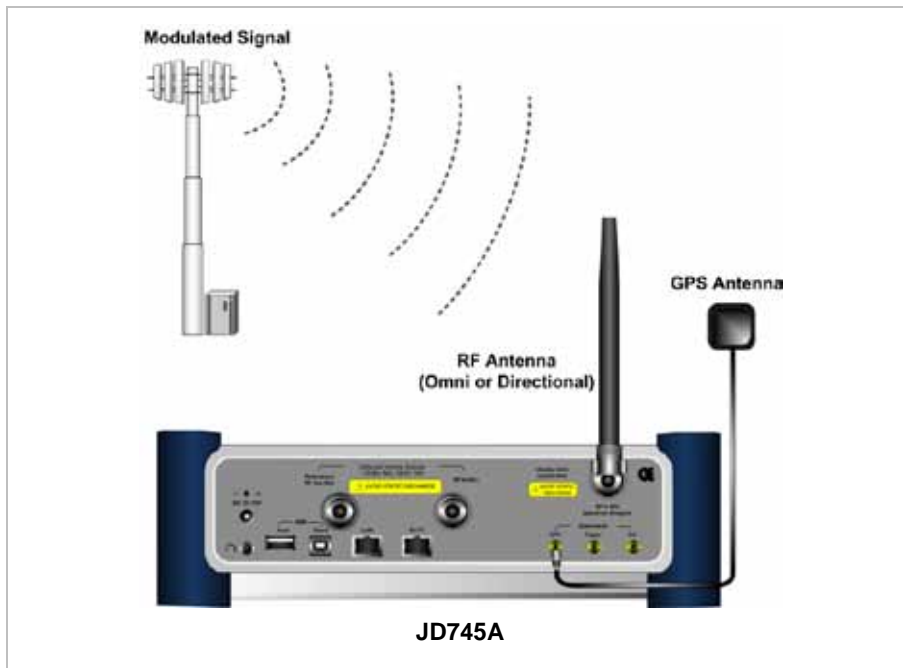



If the input signal level to be measured is less than 0 dBm, set 0 dB attenuation or turn on the preamp to have better dynamic range for the OTA testing.

SPECTRUM ANALYSIS MEASUREMENT

Setting Mode

| Step | Description |
|--|---|
| 1. Connect the cable | Connect a cable directly or indirectly as shown in the section Connecting a Cable on page 7 of this chapter. |
| 2. Select the mode MODE [Signal Analyzer] [More (1/2)] [TD-SCDMA] [Spectrum] | Press the MODE hard key. Press the Signal Analyzer soft key. Press the More (1/2) soft key to get more soft keys. Press the TD-SCDMA soft key. Press the Spectrum soft key. (Spectrum mode is set by default.) |

Setting Frequency

| Step | Description |
|--|---|
| 1. Set the frequency FREQ/DIST [Unit] <Freq> or <Channel> | Press the FREQ/DIST hard key. Press the Unit soft key. Toggle this key between Freq and Channel . A set of Freq/Dist screen menu changes accordingly. |
| <i>When Freq is selected:</i> [Center Frequency] Enter a value [GHz], [MHz], [kHz], or [Hz] | Press the Center Frequency soft key. Use the numeric keys, the rotary knob, or the arrow keys. When using the numeric keys, the input is completed by selecting one of the unit soft keys. |
| <i>When Channel is selected:</i> [Channel Standard] Select a channel standard | Press the Channel Standard soft key. Press the arrow keys, rotate the knob, or press the Page Up and Page Down soft keys to highlight a frequency band to |

| | |
|---|--|
| <p>[Select] or ENTER</p> | <p>select. Press the Select soft key or the ENTER hard key.</p> |
| <p>[Channel Number] Enter a value [Forward]</p> | <p>Press the Channel Number soft key. Use the numeric keys to input value and press the Forward soft key to complete the input. The instrument automatically displays its corresponding center frequency value for the channel number.</p> |

FREQ/DIST



- n **UNIT:** Determines the way how to set the frequency band either with standard band or custom frequency band. Toggling this key between **Freq** and **Channel** changes a set of Freq/Dist screen menu automatically.
- n **CENTER FREQUENCY:** Changes the center frequency setting. Use the rotary knob or the arrow keys. Or use the numeric keys to input a certain value and press one of the unit soft keys to complete the input.
- n **FREQUENCY STEP:** Defines the amount of frequency to be increased or decreased when using the rotary knob or the arrow keys to change the **Center Frequency**. This frequency step size can be entered by using numeric keys and the unit soft keys.
- n **CHANNEL NUMBER:** Enters a channel number. The instrument automatically displays its corresponding center frequency value for the channel number.
- n **CHANNEL STEP:** Defines the amount of channel to be increased or decreased when using the rotary knob or the arrow keys to change the **Channel Number**. This channel step size can be entered by using numeric keys and the **Enter** soft key.
- n **CHANNEL STANDARD:** When the channel standard is selected from the list, the center frequency information on the display screen will be mapped accordingly to the selected channel standard. The channel standards available in the instrument are listed in the Appendix C – Band, Frequency & Channel Standard.

Setting Amplitude

| Step | Description |
|--|--|
| <p>1. Set the reference/attenuation level AMP/SCALE [Auto Scale]</p> | <p>Press the AMP/SCALE hard key. Press the Auto Scale soft key to automatically set optimum levels of reference and attenuation.</p> |

| | |
|--|---|
| or | |
| [Reference Level] Enter a reference level value | Press the Reference Level soft key to set manually. Use the numeric keys or the rotary knob that changes in a 10 dB step. |
| [dBm] or ENTER | Press the dBm soft key or the ENTER hard key. |
| [Attenuation] <Manual> Enter an attenuation value | Press the Attenuation soft key. The Auto mode is set by default. This key toggles between the Auto and Manual . Press the Attenuation soft key to highlight the Manual mode and change the attenuation value to optimize S/N. Use the numeric keys or the rotary knob that changes in a 5 dB step. The attenuation setting range is 0 to 50 dB. |

AMP/SCALE



- n **AUTO SCALE:** The instrument can automatically set the scale to the minimum and maximum values on the Y-axis of the graph for optimum display of the traces measured. Each time the **Auto Scale** is selected, the top and bottom scales are set to the minimum and maximum values with margin on the Y-axis of the display screen and attenuation is set to its optimum value.
- n **REFERENCE LEVEL:** Sets the maximum Y-axis range.
- n **SCALE/DIV:** Is used only for the Spectrum measurement screen. It represents the value of one division on the horizontal scale. The default value is 10 dB per division and the Y-Scale is set to 100 dB. Selecting the **Scale/Div** soft key enables to set the value to 1 dB per division with the numeric keys or the rotary knob.
- n **ATTENUATION**
 - Y **AUTO:** Input attenuator's value is automatically set depending on the reference level. This is the default operation mode, so it is recommended to use this mode unless a special measurement condition is needed.
 - Y **MANUAL:** Sets the attenuator's value for the **Spectrum Analyzer RF In 50 Ω** port.
- n **PREAMP:** Turns on or off the internal pre-amplifier. Preamp results in a correction being applied to compensate for the gain of the preamp so that amplitude readings show the value at the input connector. This soft key toggles between the **On** and **Off**. When it is set to On, the allowable attenuation input range is from 0 dB to 10 dB in a multiple of 5. If the attenuation value is manually set greater than 10 dB, the instrument will automatically turn off the pre-amplifier to display low level signal properly on the screen.
- n **UNITS:** Sets the scale unit on the display among **dBm**, **dBV**, **dBmV**, **dBuV**, **V**, and **W**.
- n **EXTERNAL OFFSET:** Sets an external offset value. An offset consists of a cable loss and a user

offset and the measurement result shows the value reflecting both offset values. When the external offset value is set at 40 dB in the Spectrum mode, the measurement result compensates 40 dB at both the Spectrum Analyzer and Signal Analyzer modes.

Setting Averaging

BW/AVG



- n **AVERAGE:** Sets the number of measurements to be averaged for the trace presentation. A maximum of 100 times of averaging can be set.

| Step | Description |
|--|--|
| 1. Set the averaging BW/AVG [Average] | Press the BW/AVG hard key. Press the Average soft key. |
| 2. Enter number of averaging to set | Use the numeric keys and input a number between 1 and 100. When the averaging reaches to the number set here, a new measurement value replaces the earliest measurement value in sequence. |
| 3. [Enter] or ENTER | Press the Enter soft key or the ENTER hard key. |

Setting Sweep Mode

SWEEP



This hot key is used to set the sweep parameters. The user input window must be inactive first to get the Sweep hot key function other than the number input.

- n **SWEEP MODE:** Sets the sweep method. Toggle between **Continue** and **Single**.

| Step | Description |
|---|---|
| 1. Set the sweep mode SWEEP [Sweep Mode] | Press the SWEEP hot key. Press the Sweep Mode soft key. Toggle between Continue and Single . |

Setting Trigger Source

TRIGGER



This hot key is used to select the trigger source among **Internal**, **External**, and **GPS**. The user input window must be inactive first to get the Trigger hot key function other than the number input.

Setting External Clock

To enhance the reliability of modulation analysis measurements the JD740AA series must be synchronized with the Base Station. When an external clock is not supplied, the JD740AA series works with a built-in internal high-accuracy time base. In this case, some measurement results may exhibit inaccurate values. Therefore, it is highly recommended to use the same reference clock as signal source. Trigger mode can be changed by using the **TRIGGER** hot key.

EXTERNAL CLOCK OPERATING STANDARDS

| Clock | Type | Reference | Port | Switching Standard |
|--------------------|----------|--------------------|---------------|--|
| External Reference | Internal | Internal 10 MHz | | Default |
| | External | External Ref Clock | Ext Ref (SMA) | Manual switching (Input signal level >-3 dBm) |
| | GPS | GPS Clock | GPS (SMA) | Automatic switching (GPS signal received) |
| Trigger | Internal | Internal Trigger | | Default |
| | External | External Trigger | Trigger (SMA) | Manual switching |
| | GPS | GPS | GPS (SMA) | Manual switching |

CONNECTION

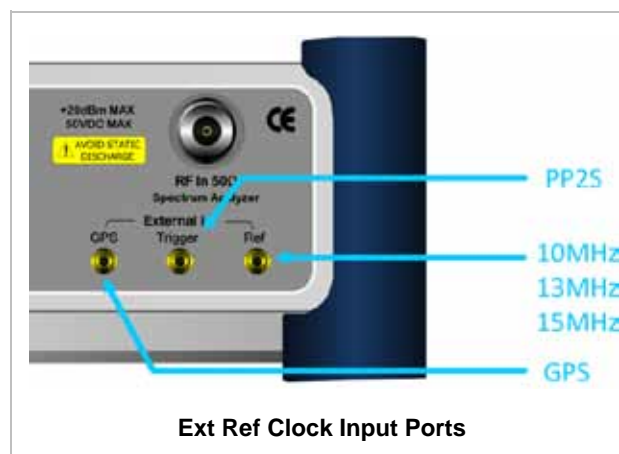

ENABLING EXTERNAL REFERENCE

| Step | Description |
|--|--|
| 1. Connect an external reference | Connect one of the external references or a GPS antenna to the JD740AA series. |
| 2. Change reference clock SYSTEM [Frequency Reference] [External 10 MHz], [External 13 MHz], [External 15 MHz] or [GPS] | Press the SYSTEM hot key. Press the Frequency Reference soft key to select one of the external reference clocks or GPS. Press one of the soft keys to choose among External 10 MHz , External 13 MHz , External 15 MHz , and GPS . |

EXTERNAL REFERENCE INDICATOR INFORMATION

Each indicator tells different locking status according to a connection. When a GPS antenna is connected, longitude and latitude information will be displayed on the screen.

| Type | Indicator | Description |
|----------|--|----------------------------------|
| Internal |  (Green) | Locked |
| External |  (Green) | Locked |
| |  (Red) | Unlocked |
| GPS |  (Green) | Locked |
| |  (Yellow) | Locking in progress |
| |  (Gray) | Unable to lock or antenna failed |

Setting Trace and Display

TRACE/DISPLAY

- n **SELECT TRACE:** Selects an active trace from T1 to T6. Trace numbers are assigned to each captured trace or loaded trace. Pressing one of the 6 trace number soft keys sets the selected trace number as the active trace on the display screen.
- n **CLEAR WRITE:** Clears the selected trace and writes or assigns the current trace.
- n **MAX HOLD:** Sets the active trace to display the maximum response of the input signal. Active trace compares newly acquired data with the trace shown on the screen and displays the bigger trace on the display screen.
- n **MIN HOLD:** Sets the active trace to display the minimum response of the input signal. Active trace compares newly acquired data with the trace shown on the screen and displays the smaller trace

on the display screen.

- n **CAPTURE:** Captures a current trace on the display screen with the selected trace number.
- n **TRACE VIEW:** Displays the trace of the selected trace number on the display screen or hides it from the display screen. Press the **Select Trace** soft key to select a trace number and then press the **Trace View** soft key to toggle between the **Off** to hide and **On** to restore a hidden trace.
- n **TRACE CLEAR ALL:** Deletes all traces from the instrument and initializes the trace settings.

Measurement Procedure

| Step | Description |
|--|---|
| 1. Select the measurement mode MEASURE [Spectrum] | Press the MEASURE hot key. Press the Spectrum soft key. |
| 2. Set the measurement parameters MEASURE SETUP [Slot Number] [TS0], [TS1], [TS2], [TS3], [TS4], [TS5], or [TS6] | Press the MEASURE SETUP hot key. Press the Slot Number soft key. Press one of the soft keys to select the time slot number. |

TD-SCDMA Spectrum Measurement Procedure

MEASURE SETUP



- n **DELAY:** Sets the delay in micro seconds. This key is used only when there is a time offset in the signals to be measured.
- n **SLOT NUMBER:** Sets the time slot number to be displayed on the measurement screen. Select the slot number among **TS0, TS1, TS2, TS3, TS4, TS5** and **TS6**.

Measurement Example

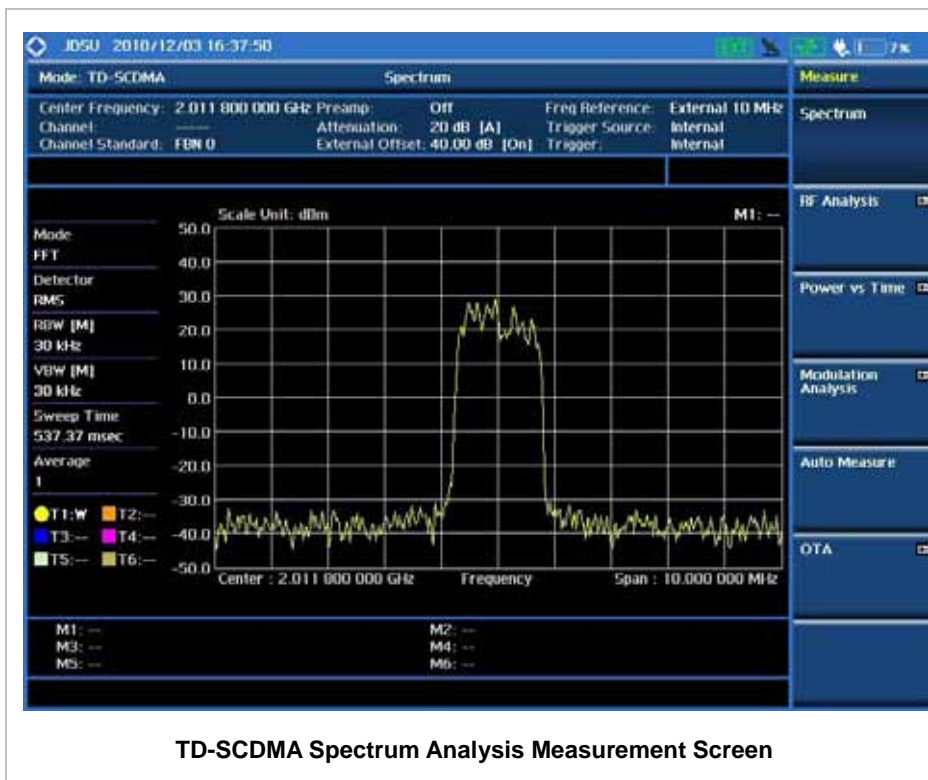

RF ANALYSIS MEASUREMENTS

RF Analysis in TD-SCDMA Signal Analyzer provides single-button measurements for the following measurements.

- n Channel Power
- n Occupied Bandwidth
- n Spectrum Emission Mask
- n Adjacent Channel Leakage Power Ratio (ACLR)
- n Multi-ACLR
- n Spurious Emissions

Setting Mode

| Step | Description |
|----------------------|--|
| 1. Connect the cable | Connect a cable directly or indirectly as shown in the |

| | |
|--|--|
| | section Connecting a Cable on page 7 of this chapter. |
| <p>2. Select the mode</p> <p>MODE</p> <p>[Signal Analyzer]</p> <p>[More (1/2)]</p> <p>[TD-SCDMA]</p> <p>[RF Analysis]</p> <p>[Channel Power],</p> <p>[Occupied BW],</p> <p>[Spectrum Emission Mask],</p> <p>[ACLR],</p> <p>[Multi-ACLR], or</p> <p>[Spurious Emissions]</p> | <p>Press the MODE hard key.</p> <p>Press the Signal Analyzer soft key.</p> <p>Press the More (1/2) soft key to get more soft keys.</p> <p>Press the TD-SCDMA soft key.</p> <p>Press the RF Analysis soft key.</p> <p>Press one of the measurement mode soft keys to select.</p> |

Setting Frequency

This setting is not used in the Multi-ACLR mode and the Spurious Emissions mode.

| Step | Description |
|--|--|
| <p>1. Set the frequency</p> <p>FREQ/DIST</p> <p>[Unit]</p> <p><Freq> or <Channel></p> <p><i>When Freq is selected:</i></p> <p>[Center Frequency]</p> <p>Enter a value</p> <p>[GHz], [MHz], [kHz], or [Hz]</p> <p><i>When Channel is selected:</i></p> <p>[Channel Standard]</p> <p>Select a channel standard</p> <p>[Select] or ENTER</p> <p>[Channel Number]</p> <p>Enter a value</p> <p>[Forward]</p> | <p>Press the FREQ/DIST hard key.</p> <p>Press the Unit soft key. Toggle this key between Freq and Channel. A set of Freq/Dist screen menu changes accordingly.</p> <p>Press the Center Frequency soft key.</p> <p>Use the numeric keys, the rotary knob, or the arrow keys.</p> <p>When using the numeric keys, the input is completed by selecting one of the unit soft keys.</p> <p>Press the Channel Standard soft key.</p> <p>Press the arrow keys, rotate the knob, or press the Page Up and Page Down soft keys to highlight a frequency band to select.</p> <p>Press the Select soft key or the ENTER hard key.</p> <p>Press the Channel Number soft key.</p> <p>Use the numeric keys to input value and press the Forward soft key to complete the input. The instrument automatically displays its corresponding center frequency value for the</p> |

channel number.

FREQ/DIST



- n **UNIT:** Determines the way how to set the frequency band either with standard band or custom frequency band. Toggling this key between **Freq** and **Channel** changes a set of Freq/Dist screen menu automatically.
- n **CENTER FREQUENCY:** Changes the center frequency setting. Use the rotary knob or the arrow keys. Or use the numeric keys to input a certain value and press one of the unit soft keys to complete the input.
- n **FREQUENCY STEP:** Defines the amount of frequency to be increased or decreased when using the rotary knob or the arrow keys to change the **Center Frequency**. This frequency step size can be entered by using numeric keys and the unit soft keys.
- n **CHANNEL NUMBER:** Enters a channel number. The instrument automatically displays its corresponding center frequency value for the channel number.
- n **CHANNEL STEP:** Defines the amount of channel to be increased or decreased when using the rotary knob or the arrow keys to change the **Channel Number**. This channel step size can be entered by using numeric keys and the **Enter** soft key.
- n **CHANNEL STANDARD:** When the channel standard is selected from the list, the center frequency information on the display screen will be mapped accordingly to the selected channel standard. The channel standards available in the instrument are listed in the Appendix C – Band, Frequency & Channel Standard.

Setting Amplitude

| Step | Description |
|---|--|
| 1. Set the reference/attenuation level AMP/SCALE [Auto Scale] or [Reference Level] Enter a reference level value [dBm] or ENTER | Press the AMP/SCALE hard key. Press the Auto Scale soft key to automatically set optimum levels of reference and attenuation. Press the Reference Level soft key to set manually. Use the numeric keys or the rotary knob that changes in a 10 dB step. Press the dBm soft key or the ENTER hard key. |

| | |
|--|---|
| <p>[Attenuation]</p> <p><Manual></p> <p>Enter an attenuation value</p> | <p>Press the Attenuation soft key. The Auto mode is set by default. This key toggles between the Auto and Manual.</p> <p>Press the Attenuation soft key to highlight the Manual mode and change the attenuation value to optimize S/N.</p> <p>Use the numeric keys or the rotary knob that changes in a 5 dB step. The attenuation setting range is 0 to 50 dB.</p> |
|--|---|

AMP/SCALE



- n **AUTO SCALE:** The instrument can automatically set the scale to the minimum and maximum values on the Y-axis of the graph for optimum display of the traces measured. Each time the **Auto Scale** is selected, the top and bottom scales are set to the minimum and maximum values with margin on the Y-axis of the display screen.
- n **REFERENCE LEVEL:** Sets the maximum Y-axis range.
- n **SCALE/DIV:** Is used only for the Spectrum measurement screen. It represents the value of one division on the horizontal scale. The default value is 10 dB per division and the Y-Scale is set to 100 dB. Selecting the **Scale/Div** soft key enables to set the value to 1 dB per division with the numeric keys or the rotary knob.
- n **ATTENUATION**
 - Y **AUTO:** Input attenuator's value is automatically set depending on the reference level. This is the default operation mode, so it is recommended to use this mode unless a special measurement condition is needed.
 - Y **MANUAL:** Sets the attenuator's value for the **Spectrum Analyzer RF In 50 Ω** port.
- n **PREAMP:** Turns on or off the internal pre-amplifier. Preamp results in a correction being applied to compensate for the gain of the preamp so that amplitude readings show the value at the input connector. This soft key toggles between the **On** and **Off**. When it is set to On, the allowable attenuation input range is from 0 dB to 10 dB in a multiple of 5. If the attenuation value is manually set greater than 10 dB, the instrument will automatically turn off the pre-amplifier to display low level signal properly on the screen.
- n **UNITS:** Sets the scale unit on the display among **dBm**, **dBV**, **dBmV**, **dBuV**, **V**, and **W**.
- n **EXTERNAL OFFSET:** Sets an external offset value. An offset consists of a cable loss and a user offset and the measurement result shows the value reflecting both offset values. When the external offset value is set at 40 dB in the Spectrum mode, the measurement result compensates 40 dB at both the Spectrum Analyzer and Signal Analyzer modes.

Setting Averaging

BW/AVG 

- n **AVERAGE:** Sets the number of measurements to be averaged for the trace presentation. A maximum of 100 times of averaging can be set. *This setting is not used in the Spurious Emissions mode.*

| Step | Description |
|---|--|
| 1. Set the averaging BW/AVG [Average] | Press the BW/AVG hard key. Press the Average soft key. |
| 2. Enter number of averaging to set | Use the numeric keys and input a number between 1 and 100. When the averaging reaches to the number set here, a new measurement value replaces the earliest measurement value in sequence. |
| 3. [Enter] or ENTER | Press the Enter soft key or the ENTER hard key. |

Setting Sweep Mode

SWEEP 

This hot key is used to set the sweep parameters. The user input window must be inactive first to get the Sweep hot key function other than the number input.

- n **SWEEP MODE:** Sets the sweep method. Toggle between **Continue** and **Single**.

| Step | Description |
|--|---|
| 1. Set the sweep mode SWEEP [Sweep Mode] | Press the SWEEP hot key. Press the Sweep Mode soft key. Toggle between Continue and Single . |

Setting Trigger Source

TRIGGER 

This hot key is used to select the trigger source among **Internal**, **External**, and **GPS**. The user input window must be inactive first to get the Trigger hot key function other than the number input.

Setting External Clock

To enhance the reliability of modulation analysis measurements the JD740AA series must be synchronized with the Base Station. When an external clock is not supplied, the JD740AA series works with a built-in internal high-accuracy time base. In this case, some measurement results may exhibit inaccurate values. Therefore, it is highly recommended to use the same reference clock as signal source. Trigger mode can be changed by using the **TRIGGER** hot key.

EXTERNAL CLOCK OPERATING STANDARDS

| Clock | Type | Reference | Port | Switching Standard |
|--------------------|----------|--------------------|---------------|--|
| External Reference | Internal | Internal 10 MHz | | Default |
| | External | External Ref Clock | Ext Ref (SMA) | Manual switching (Input signal level >-3 dBm) |
| | GPS | GPS Clock | GPS (SMA) | Automatic switching (GPS signal received) |
| Trigger | Internal | Internal Trigger | | Default |
| | External | External Trigger | Trigger (SMA) | Manual switching |
| | GPS | GPS | GPS (SMA) | Manual switching |

CONNECTION

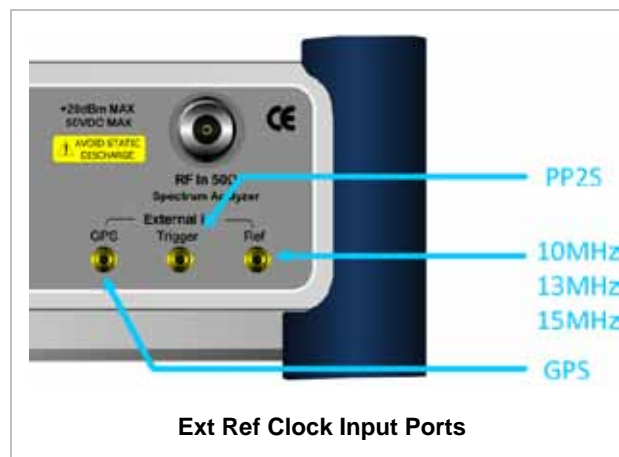

ENABLING EXTERNAL REFERENCE

| Step | Description |
|--|--|
| 1. Connect an external reference | Connect one of the external references or a GPS antenna to the JD740A series. |
| 2. Change reference clock SYSTEM [Frequency Reference] | Press the SYSTEM hot key. Press the Frequency Reference soft key to select one of the |

| | |
|---|---|
| <p>[External 10 MHz], [External 13 MHz], [External 15 MHz] or [GPS]</p> | <p>external reference clocks or GPS. Press one of the soft keys to choose among External 10 MHz, External 13 MHz, External 15 MHz, and GPS.</p> |
|---|---|

EXTERNAL REFERENCE INDICATOR INFORMATION

Each indicator tells different locking status according to a connection. When a GPS antenna is connected, longitude and latitude information will be displayed on the screen.

| Type | Indicator | Description |
|----------|---|----------------------------------|
| Internal |  (Green) | Locked |
| External |  (Green) | Locked |
| |  (Red) | Unlocked |
| GPS |  (Green) | Locked |
| |  (Yellow) | Locking in progress |
| |  (Gray) | Unable to lock or antenna failed |

CHANNEL POWER

The Channel Power measurement determines the average power of an RF signal burst at or above a specified threshold value.

The purpose of the Channel Power measurement is to determine the power delivered to the antenna system on the RF channel under test. The instrument acquires a TD-SCDMA signal in the time domain. The average power level above the threshold is then computed and displayed.

Measurement Procedure

| Step | Description |
|---|--|
| <p>1. Set the measurement mode MEASURE [RF Analysis] [Channel Power]</p> | <p>Press the MEASURE hot key. Press the RF Analysis soft key. Press the Channel Power soft key.</p> |

| | |
|---|--|
| <p>2. Set the measurement parameters</p> <p>MEASURE SETUP</p> <p>[Slot Number]</p> <p>[TS0], [TS1], [TS2], [TS3], [TS4], [TS5], or [TS6]</p> | <p>Press the MEASURE SETUP hot key.</p> <p>Press the Slot Number soft key.</p> <p>Press one of the soft keys to select the time slot number.</p> |
|---|--|

TD-SCDMA Channel Power Measurement Procedure

MEASURE SETUP 

- n **DELAY:** Sets the delay in micro seconds. This key is used only when there is a time offset in the signals to be measured.
- n **SLOT NUMBER:** Sets the time slot number to be displayed on the measurement screen. Select the slot number among **TS0, TS1, TS2, TS3, TS4, TS5** and **TS6**.

Setting Limit

LIMIT 

This hot key is used to set the threshold value for the limit line on the display screen. It turns on or off the limit or band limit settings of the measurement for pass/fail indication. The user input window must be inactive first to get the Limit hot key function other than the number input.

| Step | Description |
|--|--|
| <p>1. Select the limit</p> <p>LIMIT</p> <p>[RF Test Limits]</p> <p>[Channel Power]</p> <p>[Test Limits]</p> <p><On> or <Off></p> <p>[High Limit]</p> <p>Enter a value</p> <p>[dBm] or ENTER</p> <p>[Low Limit]</p> <p>Enter a value</p> <p>[dBm] or ENTER</p> | <p>Press the LIMIT hot key.</p> <p>Press the RF Test Limits soft key.</p> <p>Press the Channel Power soft key.</p> <p>Press the Test Limits soft key to toggle between On and Off and select one.</p> <p>Press the High Limit soft key to set the upper limit of the Pass/Fail criteria. Use the numeric keys to input value.</p> <p>Press the unit soft key or the ENTER hard key.</p> <p>Press the Low Limit soft key to set the lower limit of the Pass/Fail criteria. Use the numeric keys to input value.</p> <p>Press the unit soft key or the ENTER hard key.</p> |
| <p>2. Enable beep</p> <p>LIMIT</p> <p>[Beep]</p> <p><On> or <Off></p> | <p>Press the LIMIT hot key.</p> <p>Press the Beep soft key to toggle between On and Off and select one. This will make audible alarm if the measurement result goes beyond the limit.</p> |

- n **TEST LIMITS:** Enables or disables Pass/Fail results on the display screen. Toggle the **Test Limits** soft key to set it to **On** or **Off**.
- n **HIGH LIMIT:** Sets the upper limit of the Pass/Fail criteria. Use the numeric keys to enter a threshold or limit value and press the unit soft key or the **ENTER** hard key to complete the input.
- n **LOW LIMIT:** Sets the lower limit of the Pass/Fail criteria. Use the numeric keys to enter a threshold or limit value and press the unit soft key or the **ENTER** hard key to complete the input.

Measurement Example

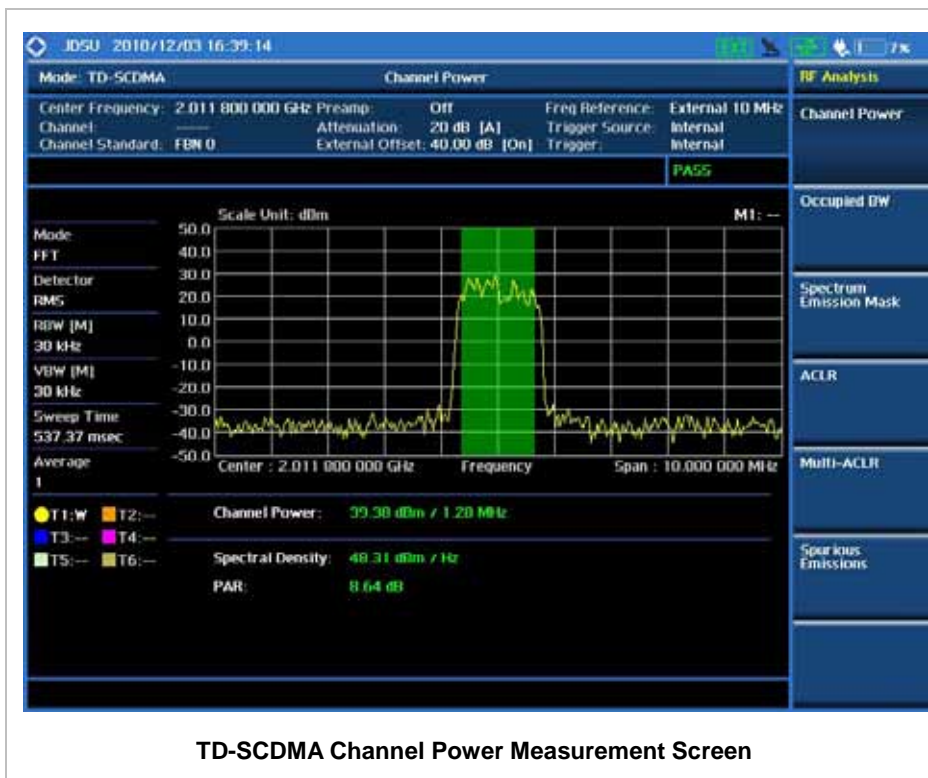

TD-SCDMA Channel Power Measurement Screen

OCCUPIED BANDWIDTH

Occupied bandwidth is a measure of the bandwidth containing 99% of the total integrated power for transmitted spectrum and is centered on the assigned channel frequency.

Measurement Procedure

| Step | Description |
|---|---|
| 1. Set the measurement mode MEASURE [RF Analysis] [Occupied BW] | Press the MEASURE hot key. Press the RF Analysis soft key. Press the Occupied BW soft key. |
| 2. Set the measurement parameters MEASURE SETUP [Slot Number] [TS0], [TS1], [TS2], [TS3], [TS4], [TS5], or [TS6] | Press the MEASURE SETUP hot key. Press the Slot Number soft key. Press one of the soft keys to select the time slot number. |

TD-SCDMA Occupied BW Measurement Procedure

MEASURE SETUP



- n **DELAY:** Sets the delay in micro seconds. This key is used only when there is a time offset in the signals to be measured.
- n **SLOT NUMBER:** Sets the time slot number to be displayed on the measurement screen. Select the slot number among **TS0**, **TS1**, **TS2**, **TS3**, **TS4**, **TS5** and **TS6**.

Setting Limit

LIMIT



This hot key is used to set the threshold value for the limit line on the display screen. It turns on or off the limit or band limit settings of the measurement for pass/fail indication. The user input window must be inactive first to get the Limit hot key function other than the number input.

| Step | Description |
|---|--|
| 1. Select the limit LIMIT [RF Test Limits] [Occupied BW] [Test Limit] <On> or <Off> [High Limit] Enter a value [MHz], [kHz], or [Hz] | Press the LIMIT hot key. Press the RF Test Limits soft key. Press the Occupied BW soft key. Press the Test Limit soft key to toggle between On and Off and select one. Press the High Limit soft key to set the upper limit of the Pass/Fail criteria. Use the numeric keys to input value. Press the unit soft key to select. |
| 2. Enable beep LIMIT | Press the LIMIT hot key. |

| | |
|---|--|
| <p>[Beep] <On> or <Off></p> | <p>Press the Beep soft key to toggle between On and Off and select one. This will make audible alarm if the measurement result goes beyond the limit.</p> |
|---|--|

- n **TEST LIMIT:** Enables or disables Pass/Fail results on the display screen. Toggle the **Test Limit** soft key to set it to **On** or **Off**.
- n **HIGH LIMIT:** Sets the upper limit of the Pass/Fail criteria. Use the numeric keys to enter a threshold or limit value and press one of the unit soft keys to complete the input.

Measurement Example

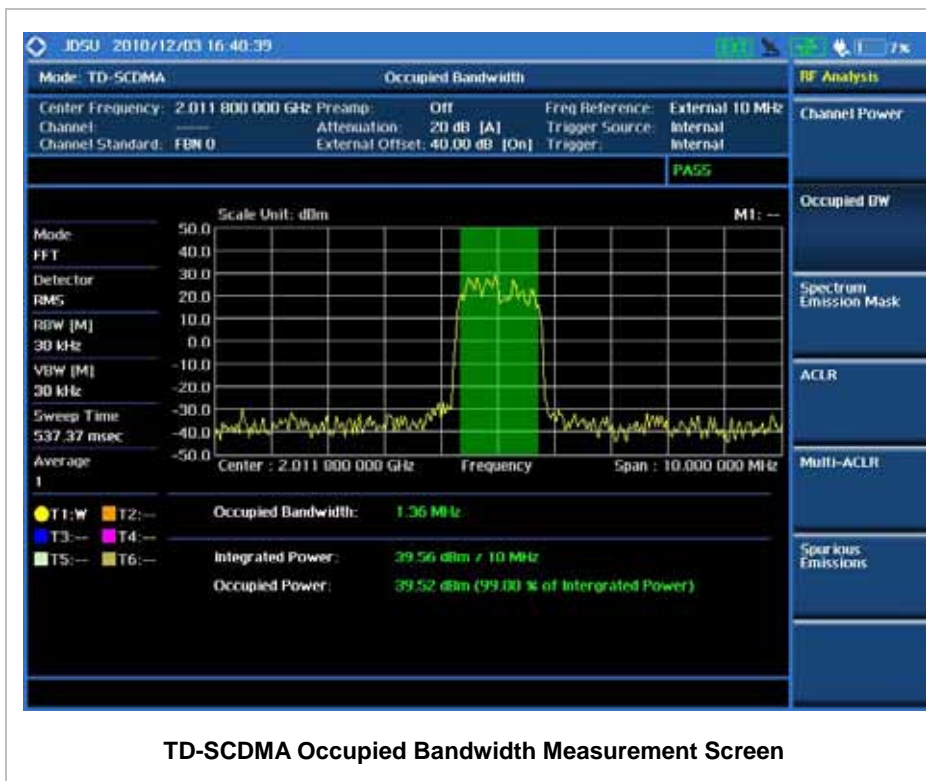

SPECTRUM EMISSION MASK (SEM)

The Spectrum Emission Mask (SEM) measurement required by 3GPP2 specifications encompasses different power limits and different measurement bandwidths (resolution bandwidths) at various frequency offsets. It may be expressed as a ratio of power spectral densities between the carrier and the specified offset frequency band. It provides useful figures-of-merit for the spectral re-growth and emissions produced by components and circuit blocks, without the rigor of performing a full SEM measurement.

The SEM measures spurious signal levels in up to five pairs of offset or region frequencies and relates them to the carrier power.

Measurement Procedure

| Step | Description |
|---|--|
| 1. Set the measurement mode MEASURE [RF Analysis] [Spectrum Emission Mask] | Press the MEASURE hot key. Press the RF Analysis soft key. Press the Spectrum Emission Mask soft key. |
| 2. Set the measurement parameters MEASURE SETUP [Mask Type] [~ 26 dBm], [26~34 dBm], or [34 dBm ~] | Press the MEASURE SETUP hot key. Press the Mask Type soft key. Press one of the soft keys to select a mask type range. |

TD-SCDMA Spectrum Emission Mask Measurement Procedure

MEASURE SETUP



- n **DELAY:** Sets the delay in micro seconds. This key is used only when there is a time offset in the signals to be measured.
- n **MASK TYPE:** Selects the mask type in accordance with the output power of the base station.

Setting Limit

LIMIT



This hot key is used to set the threshold value for the limit line on the display screen. It turns on or off the limit or band limit settings of the measurement for pass/fail indication. The user input window must be inactive first to get the Limit hot key function other than the number input.

| Step | Description |
|---|---|
| 1. Select the limit LIMIT [RF Test Limits] [Spectrum Emission Mask] [Test Limit] | Press the LIMIT hot key. Press the RF Test Limits soft key. Press the Spectrum Emission Mask soft key. Press the Test Limit soft key to toggle between On and |

| | |
|---|--|
| <On> or <Off> | Off and select one. |
| 2. Enable beep LIMIT [Beep] <On> or <Off> | Press the LIMIT hot key. Press the Beep soft key to toggle between On and Off and select one. This will make audible alarm if the measurement result goes beyond the limit. |

- n **TEST LIMIT:** Enables or disables Pass/Fail results on the display screen. Toggle the **Test Limit** soft key to set it to **On** or **Off**.

Measurement Example

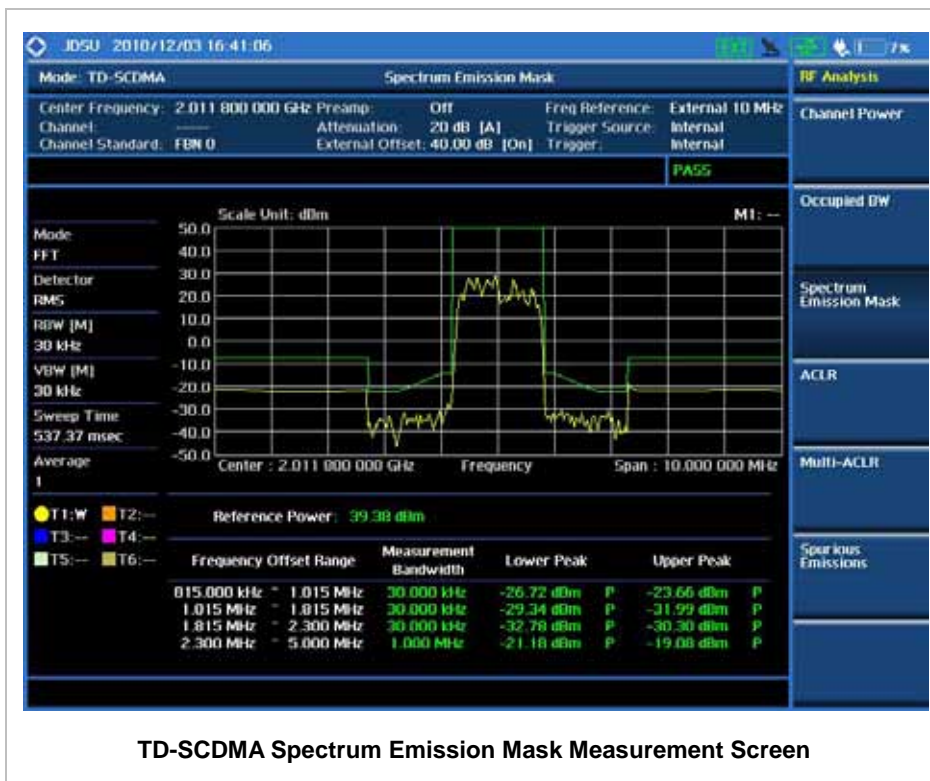

ACLR

Adjacent Channel Leakage power Ratio (ACLR) measures the amount of interference or power in an adjacent frequency channel according to the standards.

Measurement Procedure

| Step | Description |
|---|---|
| 1. Set the measurement mode MEASURE [RF Analysis] [ACLR] | Press the MEASURE hot key. Press the RF Analysis soft key. Press the ACLR soft key. |
| 2. Set the measurement parameters MEASURE SETUP [Slot Number] [TS0], [TS1], [TS2], [TS3], [TS4], [TS5], or [TS6] | Press the MEASURE SETUP hot key. Press the Slot Number soft key. Press one of the soft keys to select the time slot number. |

TD-SCDMA ACLR Measurement Procedure

MEASURE SETUP



- n **DELAY:** Sets the delay in micro seconds. This key is used only when there is a time offset in the signals to be measured.
- n **SLOT NUMBER:** Sets the time slot number to be displayed on the measurement screen. Select the slot number among **TS0**, **TS1**, **TS2**, **TS3**, **TS4**, **TS5** and **TS6**.

Setting Limit

LIMIT



This hot key is used to set the threshold value for the limit line on the display screen. It turns on or off the limit or band limit settings of the measurement for pass/fail indication. The user input window must be inactive first to get the Limit hot key function other than the number input.

| Step | Description |
|--|--|
| 1. Select the limit LIMIT [RF Test Limits] [ACLR] [Test Limit] <On> or <Off> | Press the LIMIT hot key. Press the RF Test Limits soft key. Press the ACLR soft key. Press the Test Limit soft key to toggle between On and Off and select one. |
| 2. Enable beep LIMIT [Beep] <On> or <Off> | Press the LIMIT hot key. Press the Beep soft key to toggle between On and Off and select one. This will make audible alarm if the measurement result goes beyond the limit. |

- n **TEST LIMIT:** Enables or disables Pass/Fail results on the display screen. Toggle the **Test Limit** soft key to set it to **On** or **Off**.

Measurement Example



MULTI-ACLR

The Multi-ACLR measurement is used to perform multi-channel ACLR measurements with as many channels as possible. It helps the user to measure ACLR in multi-channel transmitting Base Station environment.

Measurement Procedure

| Step | Description |
|--|--|
| 1. Set the measurement mode MEASURE [RF Analysis] [Multi-ACLR] | Press the MEASURE hot key. Press the RF Analysis soft key. Press the Multi-ACLR soft key. |

| | |
|---|--|
| <p>2. Set the measurement parameters</p> <p>MEASURE SETUP</p> <p>[Unit] <Freq> or <Channel></p> <p><i>When Freq is selected:</i></p> <p>[Lowest Frequency] Enter a value [GHz], [MHz], [kHz], or [Hz]</p> <p>[Highest Frequency] Enter a value [GHz], [MHz], [kHz], or [Hz]</p> <p><i>When Channel is selected:</i></p> <p>[Channel Standard] Select a channel standard</p> <p>[Select] or ENTER</p> <p>[Lowest Channel] Enter a value [Forward]</p> <p>[Highest Channel] Enter a value [Forward]</p> | <p>Press the MEASURE SETUP hot key.</p> <p>Press the Unit soft key. Toggle this key between Freq and Channel. A set of Freq/Dist screen menu changes accordingly.</p> <p>Press the Lowest Frequency soft key. Use the numeric keys to input value. Press one of the unit soft keys to select.</p> <p>Press the Highest Frequency soft key. Use the numeric keys to input value. Press one of the unit soft keys to select.</p> <p>Press the Channel Standard soft key. Press the arrow keys, rotate the knob, or press the Page Up and Page Down soft keys to highlight a frequency band to select. Press the Select soft key or the ENTER hard key.</p> <p>Press the Lowest Channel soft key. Use the numeric keys to input value. Press the Forward soft key.</p> <p>Press the Highest Channel soft key. Use the numeric keys to input value. Press the Forward soft key.</p> |
|---|--|

TD-SCDMA Multi-ACLR Measurement Procedure

MEASURE SETUP



- n **UNIT:** Determines the way how to set the frequency band either with standard band or custom frequency band. Toggling this key between **Freq** and **Channel** changes a set of Freq/Dist screen menu automatically.
- n **LOWEST FREQUENCY:** Sets the center frequency of the far left end on the display. Use the numeric keys to enter a value and press one of the unit soft keys to complete the input.
- n **HIGHEST FREQUENCY:** Sets the center frequency of the far right end on the display. Use the numeric keys to enter a value and press one of the unit soft keys to complete the input.
- n **LOWEST CHANNEL:** Sets the channel number of the far left end on the display.
- n **HIGHEST CHANNEL:** Sets the channel number of the far right end on the display.
- n **CHANNEL STANDARD:** When the channel standard is selected from the list, the center

frequency information on the display screen will be mapped accordingly to the selected channel standard. The channel standards available in the instrument are listed in the Appendix C – Band, Frequency & Channel Standard.

Setting Limit



This hot key is used to set the threshold value for the limit line on the display screen. It turns on or off the limit or band limit settings of the measurement for pass/fail indication. The user input window must be inactive first to get the Limit hot key function other than the number input.

| Step | Description |
|--|--|
| 1. Select the limit LIMIT [RF Test Limits] [Multi-ACLR] [Test Limit] <On> or <Off> | Press the LIMIT hot key. Press the RF Test Limits soft key. Press the Multi-ACLR soft key. Press the Test Limit soft key to toggle between On and Off and select one. |
| 2. Enable beep LIMIT [Beep] <On> or <Off> | Press the LIMIT hot key. Press the Beep soft key to toggle between On and Off and select one. This will make audible alarm if the measurement result goes beyond the limit. |

- n **TEST LIMIT:** Enables or disables Pass/Fail results on the display screen. Toggle the **Test Limit** soft key to set it to **On** or **Off**.

Measurement Example



SPURIOUS EMISSIONS

Out-of-band emissions are unwanted emissions immediately outside the channel bandwidth resulting from the modulation process and non-linearity in the transmitter but excluding spurious emissions. The Spurious Emissions measurement is to identify and determine the power level of out-of-band spurious emission within the necessary channel bandwidth and modulated signal measured at the RF port of the Base Station.

Measurement Procedure

| Step | Description |
|--|--|
| 1. Set the measurement mode MEASURE [RF Analysis] [Spurious Emissions] | Press the MEASURE hot key. Press the RF Analysis soft key. Press the Spurious Emissions soft key. |
| 2. Set the measurement parameters MEASURE SETUP [Range Table] [Range] | Press the MEASURE SETUP hot key. Press the Range Table soft key. Press the Range soft key. |

| | |
|---|--|
| Enter a value [Enter] [Start Frequency] Enter a value [GHz], [MHz], [kHz], or [Hz] [Stop Frequency] Enter a value [GHz], [MHz], [kHz], or [Hz] [Start Limit] Enter a value [dBm] [Stop Limit] Enter a value [dBm] [Attenuation] Enter a value [dB] or ENTER [RBW] Enter a value [GHz], [MHz], [kHz], or [Hz] [VBW] Enter a value [GHz], [MHz], [kHz], or [Hz] [Measure Type] <Examine> or <Full> [Average] Enter a value [Enter] or ENTER | Use the numeric keys to select the range number. Press the Enter soft key. Press the Start Frequency soft key. Use the numeric keys. Press one of the unit soft keys to select. Press the Stop Frequency soft key. Use the numeric keys. Press one of the unit soft keys to select. Press the Start Limit soft key. Use the numeric keys. Press the unit soft key to complete the input. Press the Stop Limit soft key. Use the numeric keys. Press the unit soft key to complete the input. Press the Attenuation soft key. Use the numeric keys to enter input value in the multiple of 5. Press the dB unit soft key or the ENTER hard key. Press the RBW soft key. Use the numeric keys. Press one of the unit soft keys to select. Press the VBW soft key. Use the numeric keys. Press one of the unit soft keys to select. Press the Measure Type soft key to toggle between Examine and Full . Press the Average soft key. Use the numeric keys to enter a value. Press the Enter soft key or the ENTER hard key. |
|---|--|

TD-SCDMA Spurious Emissions Measurement Procedure

MEASURE SETUP 

Sets the measurement parameters including range table and measurement type. The measurement settings can be saved and recalled as a file. Also, JDViewer, PC application software allows the user to set the parameters in the user’s computer to import into the instrument.

- n **RANGE TABLE:** Sets the range table parameters.
- Y **RANGE:** Adds a new range number or selects one of the existing range numbers to show or hide the particular frequency range in the range table at the bottom of the screen. Use the numeric keys to enter a range number and press the **Enter** soft key to complete the input.

Each time the **Range** soft key is press, it toggles between **On** and **Off**.

- Y **START FREQUENCY:** Sets or changes the start frequency value to be measured for the selected range number in the Range menu. Use the numeric keys to enter a value and press one of the unit soft keys.
- Y **STOP FREQUENCY:** Sets or changes the stop frequency value to be measured for the selected range number in the Range menu. Use the numeric keys to enter a value and press one of the unit soft keys.
- Y **START LIMIT:** Sets the start value of the limit line for the displayed range.
- Y **STOP LIMIT:** Sets the stop value of the limit line for the displayed range.
- Y **ATTENUATION:** Sets the attenuation value in the multiple of 5.
- Y **RBW:** Sets the resolution bandwidth for the selected range number in the Range menu.
- Y **VBW:** Sets the video bandwidth for the selected range number in the Range menu.
- n **MEASURE TYPE:** Sets the measurement type to **Examine** or **Full**. Toggle between **Examine** and **Full**. Examine mode will show selected range only. The instrument will automatically switch and show all ranges when Full is selected.
- n **RANGE:** Selects the range number to be displayed on the screen. This key is activated only when the **Measure Type** is set to **Examine** mode. Use the numeric keys to select one of the existing range numbers that are configured in the Range Table menu. Pressing the **Enter** soft key completes the input and changes the display.
- n **AVERAGE:** Sets the frequency the number of trace to be averaged.

Setting Limit



This hot key is used to set the threshold value for the limit line on the display screen. It turns on or off the limit or band limit settings of the measurement for pass/fail indication. The user input window must be inactive first to get the Limit hot key function other than the number input.

| Step | Description |
|--|--|
| 1. Select the limit LIMIT [RF Test Limits] [Spurious Emissions] [Test Limit] <On> or <Off> | Press the LIMIT hot key. Press the RF Test Limits soft key. Press the Spurious Emissions soft key. Press the Test Limit soft key to toggle between On and Off and select one. |

| | |
|--|---|
| <p>2. Enable beep</p> <p>LIMIT</p> <p>[Beep]</p> <p><On> or <Off></p> | <p>Press the LIMIT hot key.</p> <p>Press the Beep soft key to toggle between On and Off and select one. This will make audible alarm if the measurement result goes beyond the limit.</p> |
|--|---|

- n **TEST LIMIT:** Enables or disables Pass/Fail results on the display screen. Toggle the **Test Limit** soft key to set it to **On** or **Off**.

Measurement Example

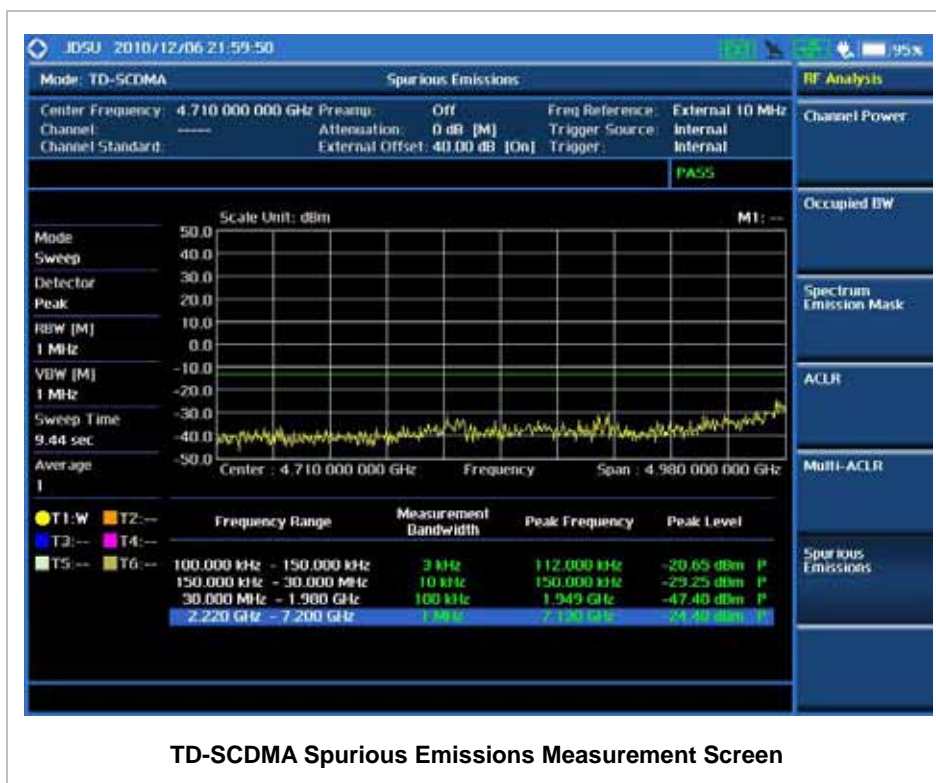

POWER VS TIME ANALYSIS MEASUREMENTS

The Power vs Time (P vs T) measurement analyzes the amplitude profile and timing of the burst signal and provides a time mask for the signal. It measures the mean transmit power during the “useful part” of TD-SCDMA bursts and verifies that the power ramp fits within the defined mask. TD-SCDMA is a Time Division Multiple Access (TDMA) scheme with seven time slots, or bursts, per RF channel and by using the “Multi-Slot” function, up to seven slots in a frame can be viewed at one time.

The TD-SCDMA Signal Analyzer provides following measurements.

- n Power vs Time (Slot)
- n Power vs Time (Frame)
- n Power vs Time (Mask)
- n Timogram

Setting Mode

| Step | Description |
|--|---|
| 1. Connect the cable | Connect a cable directly or indirectly as shown in the section Connecting a Cable on page 7 of this chapter. |
| 2. Select the mode MODE [Signal Analyzer] [More (1/2)] [TD-SCDMA] [Power vs Time] [Power vs Time (Slot)], [Power vs Time (Frame)], [Power vs Time (Mask)] ,or [Timogram] | Press the MODE hard key. Press the Signal Analyzer soft key. Press the More (1/2) soft key to get more soft keys. Press the TD-SCDMA soft key. Press the Power vs Time soft key. Press one of the measurement mode soft keys to select. |

Setting Frequency

| Step | Description |
|---|---|
| 1. Set the frequency FREQ/DIST [Unit] <Freq> or <Channel> <i>When Freq is selected:</i> [Center Frequency] Enter a value [GHz], [MHz], [kHz], or [Hz] <i>When Channel is selected:</i> | Press the FREQ/DIST hard key. Press the Unit soft key. Toggle this key between Freq and Channel . A set of Freq/Dist screen menu changes accordingly. Press the Center Frequency soft key. Use the numeric keys, the rotary knob, or the arrow keys. When using the numeric keys, the input is completed by selecting one of the unit soft keys. |

| | |
|---|--|
| <p>[Channel Standard] Select a channel standard</p> | <p>Press the Channel Standard soft key. Press the arrow keys, rotate the knob, or press the Page Up and Page Down soft keys to highlight a frequency band to select.</p> |
| <p>[Select] or ENTER</p> | <p>Press the Select soft key or the ENTER hard key.</p> |
| <p>[Channel Number] Enter a value [Forward]</p> | <p>Press the Channel Number soft key. Use the numeric keys to input value and press the Forward soft key to complete the input. The instrument automatically displays its corresponding center frequency value for the channel number.</p> |

FREQ/DIST 

- n **UNIT:** Determines the way how to set the frequency band either with standard band or custom frequency band. Toggling this key between **Freq** and **Channel** changes a set of Freq/Dist screen menu automatically.
- n **CENTER FREQUENCY:** Changes the center frequency setting. Use the rotary knob or the arrow keys. Or use the numeric keys to input a certain value and press one of the unit soft keys to complete the input.
- n **FREQUENCY STEP:** Defines the amount of frequency to be increased or decreased when using the rotary knob or the arrow keys to change the **Center Frequency**. This frequency step size can be entered by using numeric keys and the unit soft keys.
- n **CHANNEL NUMBER:** Enters a channel number. The instrument automatically displays its corresponding center frequency value for the channel number.
- n **CHANNEL STEP:** Defines the amount of channel to be increased or decreased when using the rotary knob or the arrow keys to change the **Channel Number**. This channel step size can be entered by using numeric keys and the **Enter** soft key.
- n **CHANNEL STANDARD:** When the channel standard is selected from the list, the center frequency information on the display screen will be mapped accordingly to the selected channel standard. The channel standards available in the instrument are listed in the Appendix C – Band, Frequency & Channel Standard.

Setting Amplitude

| Step | Description |
|--|---|
| <p>1. Set the reference/attenuation level AMP/SCALE</p> | <p>Press the AMP/SCALE hard key.</p> |

| | |
|---|---|
| <p>[Auto Scale]</p> <p>or</p> | <p>Press the Auto Scale soft key to automatically set optimum levels of reference and attenuation.</p> |
| <p>[Reference Level] Enter a reference level value</p> | <p>Press the Reference Level soft key to set manually. Use the numeric keys or the rotary knob that changes in a 10 dB step.</p> |
| <p>[dBm] or ENTER</p> | <p>Press the dBm soft key or the ENTER hard key.</p> |
| <p>[Attenuation] <Manual></p> | <p>Press the Attenuation soft key. The Auto mode is set by default. This key toggles between the Auto and Manual. Press the Attenuation soft key to highlight the Manual mode and change the attenuation value to optimize S/N.</p> |
| <p>Enter an attenuation value</p> | <p>Use the numeric keys or the rotary knob that changes in a 5 dB step. The attenuation setting range is 0 to 50 dB.</p> |

AMP/SCALE



- n **AUTO SCALE:** The instrument can automatically set the scale to the minimum and maximum values on the Y-axis of the graph for optimum display of the traces measured. Each time the **Auto Scale** is selected, the top and bottom scales are set to the minimum and maximum values with margin on the Y-axis of the display screen.
- n **REFERENCE LEVEL:** Sets the maximum Y-axis range.
- n **ATTENUATION**
 - Y **AUTO:** Input attenuator's value is automatically set depending on the reference level. This is the default operation mode, so it is recommended to use this mode unless a special measurement condition is needed.
 - Y **MANUAL:** Sets the attenuator's value for the **Spectrum Analyzer RF In 50 Ω** port.
- n **PREAMP:** Turns on or off the internal pre-amplifier. Preamp results in a correction being applied to compensate for the gain of the preamp so that amplitude readings show the value at the input connector. This soft key toggles between the **On** and **Off**. When it is set to On, the allowable attenuation input range is from 0 dB to 10 dB in a multiple of 5. If the attenuation value is manually set greater than 10 dB, the instrument will automatically turn off the pre-amplifier to display low level signal properly on the screen.
- n **EXTERNAL OFFSET:** Sets an external offset value. An offset consists of a cable loss and a user offset and the measurement result shows the value reflecting both offset values. When the external offset value is set at 40 dB in the Spectrum mode, the measurement result compensates 40 dB at both the Spectrum Analyzer and Signal Analyzer modes.

Setting Sweep Mode



This hot key is used to set the sweep parameters. The user input window must be inactive first to get the Sweep hot key function other than the number input.

- n **SWEEP MODE:** Sets the sweep method. Toggle between **Continue** and **Single**.

| Step | Description |
|---|---|
| 1. Set the sweep mode SWEEP [Sweep Mode] | Press the SWEEP hot key. Press the Sweep Mode soft key. Toggle between Continue and Single . |

Setting External Clock

To enhance the reliability of modulation analysis measurements the JD740A series must be synchronized with the Base Station. When an external clock is not supplied, the JD740A series works with a built-in internal high-accuracy time base. In this case, some measurement results may exhibit inaccurate values. Therefore, it is highly recommended to use the same reference clock as signal source. Trigger mode can be changed by using the **TRIGGER** hot key.

EXTERNAL CLOCK OPERATING STANDARDS

| Clock | Type | Reference | Port | Switching Standard |
|--------------------|----------|--------------------|---------------|--|
| External Reference | Internal | Internal 10 MHz | | Default |
| | External | External Ref Clock | Ext Ref (SMA) | Manual switching (Input signal level >-3 dBm) |
| | GPS | GPS Clock | GPS (SMA) | Automatic switching (GPS signal received) |
| Trigger | Internal | Internal Trigger | | Default |
| | External | External Trigger | Trigger (SMA) | Manual switching |
| | GPS | GPS | GPS (SMA) | Manual switching |

CONNECTION

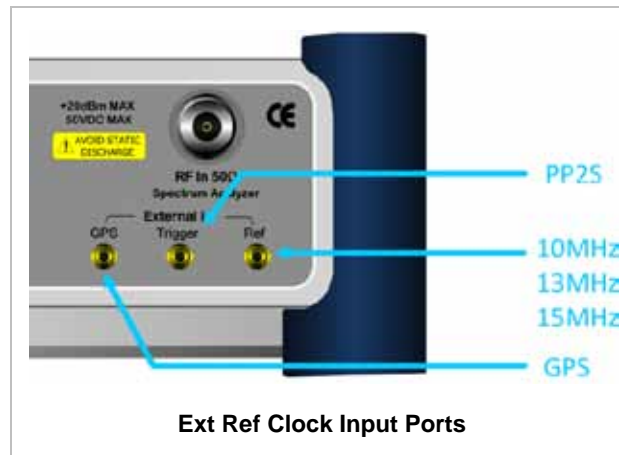

ENABLING EXTERNAL REFERENCE

| Step | Description |
|--|--|
| 1. Connect an external reference | Connect one of the external references or a GPS antenna to the JD740A series. |
| 2. Change reference clock SYSTEM [Frequency Reference] [External 10 MHz], [External 13 MHz], [External 15 MHz] or [GPS] | Press the SYSTEM hot key. Press the Frequency Reference soft key to select one of the external reference clocks or GPS. Press one of the soft keys to choose among External 10 MHz , External 13 MHz , External 15 MHz , and GPS . |

EXTERNAL REFERENCE INDICATOR INFORMATION

Each indicator tells different locking status according to a connection. When a GPS antenna is connected, longitude and latitude information will be displayed on the screen.

| Type | Indicator | Description |
|----------|-----------|----------------------------------|
| Internal | (Green) | Locked |
| External | (Green) | Locked |
| | (Red) | Unlocked |
| GPS | (Green) | Locked |
| | (Yellow) | Locking in progress |
| | (Gray) | Unable to lock or antenna failed |

POWER VS TIME (SLOT)

Measurement Procedure

| Step | Description |
|---|---|
| 1. Set the measurement mode MEASURE [Power vs Time] [Power vs Time (Slot)] | Press the MEASURE hot key. Press the Power vs Time soft key. Press the Power vs Time (Slot) soft key. |
| 2. Set the measurement parameters MEASURE SETUP [Spread Factor] [DL Auto], [UL Auto], [SF1], [SF2], [SF4], [SF8], or [SF16] [Max User] Enter a value [Enter] or ENTER [Slot Number] [TS0], [TS1], [TS2], [TS3], [TS4], [TS5], or [TS6] | Press the MEASURE SETUP hot key. Press the Spread Factor soft key. Press the soft key to choose. Press the Max User soft key to set the maximum number. Use the numeric keys to input an even number. Press the Enter soft key or the ENTER hard key. Press the Slot Number soft key. Press one of the soft keys to select the time slot number. |

TD-SCDMA Power vs Time (Slot) Measurement Procedure

MEASURE SETUP



- n **SPREAD FACTOR:** Sets the spread factor by selecting among **DL Auto** (Auto detection for Downlink), **UL Auto** (Auto detection for Uplink), **SF1**, **SF2**, **SF4**, **SF8**, and **SF16**.
- n **MAX USER:** Sets the number of users up to 16. The number must be an even number. Use the numeric keys to input value and press the **Enter** soft key to complete the input.
- n **SLOT NUMBER:** Sets the time slot number to be displayed on the measurement screen. Select the slot number among **TS0**, **TS1**, **TS2**, **TS3**, **TS4**, **TS5** and **TS6**.
- n **DELAY:** Sets the delay in micro seconds. This key is used only when there is a time offset in the signals to be measured.
- n **MISCELLANEOUS**
 - Y **DETECT MODE:** Sets the modulation type to **Auto**, **QPSK/8PSK**, **QPSK**, **8PSK**, or **16QAM**.

- Y **SCRAMBLE:** Sets the type of detecting method to determine scrambling estimation.
 - **SPEC:** Searches based on TD-SCDMA specification. Searches “Sync Sequence Number” from 0 to 31 and determines “Scrambling Code Number” using sync sequence number.
 - **FULL:** Fully searches “Scrambling Code Number” from 0 to 127.
- Y **MID SF MAP:** Sets the type of detecting method to determine Midamble spreading factor estimation either in full search or maximum power search.
 - **MAX:** Determines spread factor of Midamble using the maximum power of received Midamble.
 - **SPEC:** Searches based on TD-SCDMA specification, “Default Midamble Allocation”.

Setting Limit



This hot key is used to set the threshold value for the limit line on the display screen. It turns on or off the limit or band limit settings of the measurement for pass/fail indication. The user input window must be inactive first to get the Limit hot key function other than the number input.

| Step | Description |
|---|--|
| 1. Select the limit LIMIT [PvsT Test Limits] [Slot Power] [Test Limits] <On> or <Off> [High Limit] Enter a value [dBm] or ENTER [Low Limit] Enter a value [dBm] or ENTER [DwPTS Power] [Test Limits] <On> or <Off> [High Limit] Enter a value [dBm] or ENTER | Press the LIMIT hot key. Press the PvsT Test Limits soft key. Press the Slot Power soft key. Press the Test Limits soft key to toggle between On and Off and select one. Press the High Limit soft key to set the upper limit of the Pass/Fail criteria. Use the numeric keys to input value. Press the unit soft key or the ENTER hard key. Press the Low Limit soft key to set the lower limit of the Pass/Fail criteria. Use the numeric keys to input value. Press the unit soft key or the ENTER hard key. Press the DwPTS Power soft key. Press the Test Limits soft key to toggle between On and Off and select one. Press the High Limit soft key to set the upper limit of the Pass/Fail criteria. Use the numeric keys to input value. Press the unit soft key or the ENTER hard key. |

| | |
|---|--|
| <p>[Low Limit] Enter a value [dBm] or ENTER</p> <p>[UpPTS Power] [Test Limits] <On> or <Off></p> <p>[High Limit] Enter a value [dBm] or ENTER</p> <p>[Low Limit] Enter a value [dBm] or ENTER</p> <p>[On/Off Ratio] [Test Limits] <On> or <Off></p> <p>[High Limit] Enter a value [dB] or ENTER</p> <p>[Low Limit] Enter a value [dB] or ENTER</p> | <p>Press the Low Limit soft key to set the lower limit of the Pass/Fail criteria. Use the numeric keys to input value. Press the unit soft key or the ENTER hard key.</p> <p>Press the UpPTS Power soft key.</p> <p>Press the Test Limits soft key to toggle between On and Off and select one.</p> <p>Press the High Limit soft key to set the upper limit of the Pass/Fail criteria. Use the numeric keys to input value. Press the unit soft key or the ENTER hard key.</p> <p>Press the Low Limit soft key to set the lower limit of the Pass/Fail criteria. Use the numeric keys to input value. Press the unit soft key or the ENTER hard key.</p> <p>Press the On/Off Ratio soft key.</p> <p>Press the Test Limits soft key to toggle between On and Off and select one.</p> <p>Press the High Limit soft key to set the upper limit of the Pass/Fail criteria. Use the numeric keys to input value. Press the unit soft key or the ENTER hard key.</p> <p>Press the Low Limit soft key to set the lower limit of the Pass/Fail criteria. Use the numeric keys to input value. Press the unit soft key or the ENTER hard key.</p> |
| <p>2. Enable beep LIMIT [Beep] <On> or <Off></p> | <p>Press the LIMIT hot key.</p> <p>Press the Beep soft key to toggle between On and Off and select one. This will make audible alarm if the measurement result goes beyond the limit.</p> |

- n **SLOT POWER:** Sets limits of the power of the slots.
- Y **TEST LIMITS:** Enables or disables Pass/Fail results on the display screen. Toggle the **Test Limits** soft key to set it to **On** or **Off**.
- Y **HIGH LIMIT:** Sets the upper limit of the Pass/Fail criteria. Use the numeric keys to enter a threshold or limit value and press the **dBm** unit soft key or the **ENTER** hard key to complete the input.
- Y **LOW LIMIT:** Sets the lower limit of the Pass/Fail criteria. Use the numeric keys to enter a threshold or limit value and press the **dBm** unit soft key or the **ENTER** hard key to complete the input.
- n **DwPTS POWER:** Sets limits of the power in the Downlink Pilot Signal.
- Y **TEST LIMITS:** Enables or disables Pass/Fail results on the display screen. Toggle the **Test Limits** soft key to set it to **On** or **Off**.

- Y **HIGH LIMIT:** Sets the upper limit of the Pass/Fail criteria. Use the numeric keys to enter a threshold or limit value and press the **dBm** unit soft key or the **ENTER** hard key to complete the input.
- Y **LOW LIMIT:** Sets the lower limit of the Pass/Fail criteria. Use the numeric keys to enter a threshold or limit value and press the **dBm** unit soft key or the **ENTER** hard key to complete the input.
- n **UpPTS POWER:** Sets limits of the power in the Uplink Pilot Signal.
 - Y **TEST LIMITS:** Enables or disables Pass/Fail results on the display screen. Toggle the **Test Limits** soft key to set it to **On** or **Off**.
 - Y **HIGH LIMIT:** Sets the upper limit of the Pass/Fail criteria. Use the numeric keys to enter a threshold or limit value and press the **dBm** unit soft key or the **ENTER** hard key to complete the input.
 - Y **LOW LIMIT:** Sets the lower limit of the Pass/Fail criteria. Use the numeric keys to enter a threshold or limit value and press the **dBm** unit soft key or the **ENTER** hard key to complete the input.
- n **ON/OFF RATIO:** Sets limits of the ratio of the power between on and off portions of the Downlink slots.
 - Y **TEST LIMITS:** Enables or disables Pass/Fail results on the display screen. Toggle the **Test Limits** soft key to set it to **On** or **Off**.
 - Y **HIGH LIMIT:** Sets the upper limit of the Pass/Fail criteria. Use the numeric keys to enter a threshold or limit value and press the **dB** unit soft key or the **ENTER** hard key to complete the input.
 - Y **LOW LIMIT:** Sets the lower limit of the Pass/Fail criteria. Use the numeric keys to enter a threshold or limit value and press the **dB** unit soft key or the **ENTER** hard key to complete the input.

Measurement Example

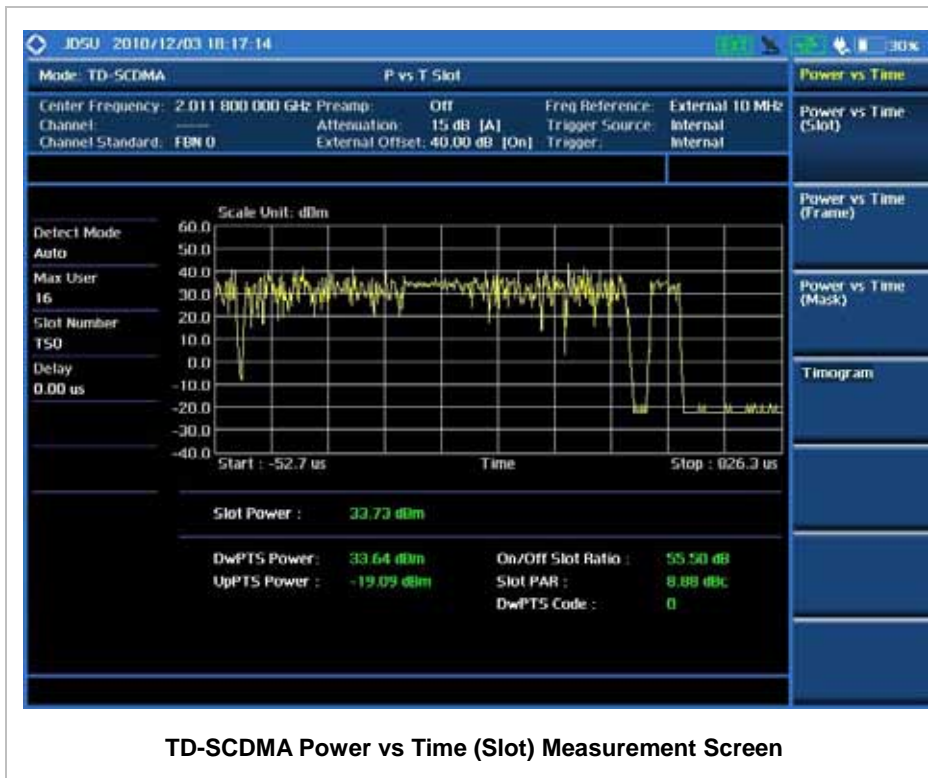

TD-SCDMA Power vs Time (Slot) Measurement Screen

POWER VS TIME (FRAME)

Measurement Procedure

| Step | Description |
|---|---|
| 1. Set the measurement mode MEASURE [Power vs Time] [Power vs Time (Frame)] | Press the MEASURE hot key. Press the Power vs Time soft key. Press the Power vs Time (Frame) soft key. |
| 2. Set the measurement parameters MEASURE SETUP [Spread Factor] [DL Auto], [UL Auto], [SF1], [SF2], [SF4], [SF8], or [SF16] [Max User] Enter a value [Enter] or ENTER | Press the MEASURE SETUP hot key. Press the Spread Factor soft key. Press the soft key to choose. Press the Max User soft key to set the maximum number. Use the numeric keys to input an even number. Press the Enter soft key or the ENTER hard key. |

| | |
|--|---|
| <p>[Slot Number] [TS0], [TS1], [TS2], [TS3], [TS4], [TS5], or [TS6]</p> | <p>Press the Slot Number soft key. Press one of the soft keys to select the time slot number.</p> |
|--|---|

TD-SCDMA Power vs Time (Frame) Measurement Procedure

MEASURE SETUP



- n **SPREAD FACTOR:** Sets the spread factor by selecting among **DL Auto** (Auto detection for Downlink), **UL Auto** (Auto detection for Uplink), **SF1**, **SF2**, **SF4**, **SF8**, and **SF16**.
- n **MAX USER:** Sets the number of users up to 16. The number must be an even number. Use the numeric keys to input value and press the **Enter** soft key to complete the input.
- n **SLOT NUMBER:** Sets the time slot number to be displayed on the measurement screen. Select the slot number among **TS0**, **TS1**, **TS2**, **TS3**, **TS4**, **TS5** and **TS6**.
- n **DELAY:** Sets the delay in micro seconds. This key is used only when there is a time offset in the signals to be measured.
- n **MISCELLANEOUS**
 - Y **DETECT MODE:** Sets the modulation type to **Auto**, **QPSK/8PSK**, **QPSK**, **8PSK**, or **16QAM**.
 - Y **SCRAMBLE:** Sets the type of detecting method to determine scrambling estimation.
 - **SPEC:** Searches based on TD-SCDMA specification. Searches “Sync Sequence Number” from 0 to 31 and determines “Scrambling Code Number” using sync sequence number.
 - **FULL:** Fully searches “Scrambling Code Number” from 0 to 127.
 - Y **MID SF MAP:** Sets the type of detecting method to determine Midamble spreading factor estimation either in full search or maximum power search.
 - **MAX:** Determines spread factor of Midamble using the maximum power of received Midamble.
 - **SPEC:** Searches based on TD-SCDMA specification, “Default Midamble Allocation”.

Setting Limit

LIMIT



This hot key is used to set the threshold value for the limit line on the display screen. It turns on or off the limit or band limit settings of the measurement for pass/fail indication. The user input window must be inactive first to get the Limit hot key function other than the number input.

| Step | Description |
|---|---|
| <p>1. Select the limit</p> <p>LIMIT</p> <p>[PvsT Test Limits]</p> <p>[Slot Power]</p> <p>[Test Limits]</p> <p><On> or <Off></p> <p>[High Limit]</p> <p>Enter a value</p> <p>[dBm] or ENTER</p> <p>[Low Limit]</p> <p>Enter a value</p> <p>[dBm] or ENTER</p> <p>[DwPTS Power]</p> <p>[Test Limits]</p> <p><On> or <Off></p> <p>[High Limit]</p> <p>Enter a value</p> <p>[dBm] or ENTER</p> <p>[Low Limit]</p> <p>Enter a value</p> <p>[dBm] or ENTER</p> <p>[UpPTS Power]</p> <p>[Test Limits]</p> <p><On> or <Off></p> <p>[High Limit]</p> <p>Enter a value</p> <p>[dBm] or ENTER</p> <p>[Low Limit]</p> <p>Enter a value</p> <p>[dBm] or ENTER</p> | <p>Press the LIMIT hot key.</p> <p>Press the PvsT Test Limits soft key.</p> <p>Press the Slot Power soft key.</p> <p>Press the Test Limits soft key to toggle between On and Off and select one.</p> <p>Press the High Limit soft key to set the upper limit of the Pass/Fail criteria. Use the numeric keys to input value.</p> <p>Press the unit soft key or the ENTER hard key.</p> <p>Press the Low Limit soft key to set the lower limit of the Pass/Fail criteria. Use the numeric keys to input value.</p> <p>Press the unit soft key or the ENTER hard key.</p> <p>Press the DwPTS Power soft key.</p> <p>Press the Test Limits soft key to toggle between On and Off and select one.</p> <p>Press the High Limit soft key to set the upper limit of the Pass/Fail criteria. Use the numeric keys to input value.</p> <p>Press the unit soft key or the ENTER hard key.</p> <p>Press the Low Limit soft key to set the lower limit of the Pass/Fail criteria. Use the numeric keys to input value.</p> <p>Press the unit soft key or the ENTER hard key.</p> <p>Press the UpPTS Power soft key.</p> <p>Press the Test Limits soft key to toggle between On and Off and select one.</p> <p>Press the High Limit soft key to set the upper limit of the Pass/Fail criteria. Use the numeric keys to input value.</p> <p>Press the unit soft key or the ENTER hard key.</p> <p>Press the Low Limit soft key to set the lower limit of the Pass/Fail criteria. Use the numeric keys to input value.</p> <p>Press the unit soft key or the ENTER hard key.</p> |
| <p>2. Enable beep</p> <p>LIMIT</p> <p>[Beep]</p> <p><On> or <Off></p> | <p>Press the LIMIT hot key.</p> <p>Press the Beep soft key to toggle between On and Off and select one. This will make audible alarm if the measurement result goes beyond the limit.</p> |

n **SLOT POWER:** Sets limits of the power of the slots.

Y **TEST LIMITS:** Enables or disables Pass/Fail results on the display screen. Toggle the **Test Limits** soft key to set it to **On** or **Off**.

Y **HIGH LIMIT:** Sets the upper limit of the Pass/Fail criteria. Use the numeric keys to enter a

- threshold or limit value and press the **dBm** unit soft key or the **ENTER** hard key to complete the input.
- Y **LOW LIMIT:** Sets the lower limit of the Pass/Fail criteria. Use the numeric keys to enter a threshold or limit value and press the **dBm** unit soft key or the **ENTER** hard key to complete the input.
 - n **DwPTS POWER:** Sets limits of the power in the Downlink Pilot Signal.
 - Y **TEST LIMITS:** Enables or disables Pass/Fail results on the display screen. Toggle the **Test Limits** soft key to set it to **On** or **Off**.
 - Y **HIGH LIMIT:** Sets the upper limit of the Pass/Fail criteria. Use the numeric keys to enter a threshold or limit value and press the **dBm** unit soft key or the **ENTER** hard key to complete the input.
 - Y **LOW LIMIT:** Sets the lower limit of the Pass/Fail criteria. Use the numeric keys to enter a threshold or limit value and press the **dBm** unit soft key or the **ENTER** hard key to complete the input.
 - n **UpPTS POWER:** Sets limits of the power in the Uplink Pilot Signal.
 - Y **TEST LIMITS:** Enables or disables Pass/Fail results on the display screen. Toggle the **Test Limits** soft key to set it to **On** or **Off**.
 - Y **HIGH LIMIT:** Sets the upper limit of the Pass/Fail criteria. Use the numeric keys to enter a threshold or limit value and press the **dBm** unit soft key or the **ENTER** hard key to complete the input.
 - Y **LOW LIMIT:** Sets the lower limit of the Pass/Fail criteria. Use the numeric keys to enter a threshold or limit value and press the **dBm** unit soft key or the **ENTER** hard key to complete the input.
 - n **ON/OFF RATIO:** *This key is not used in this measurement.*

Measurement Example

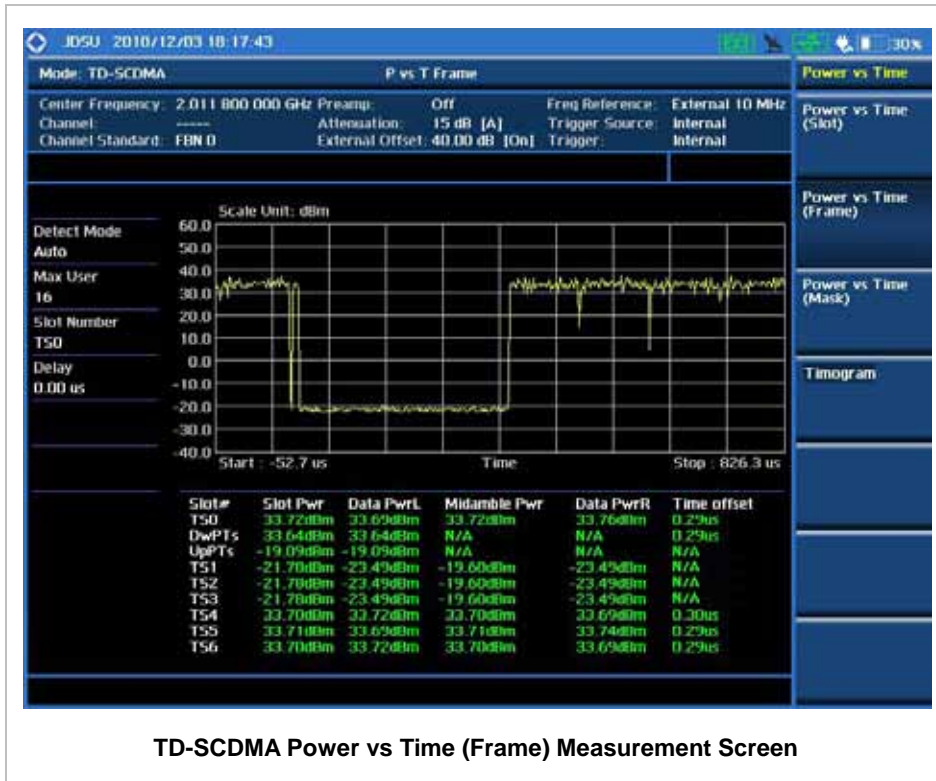

TD-SCDMA Power vs Time (Frame) Measurement Screen

POWER VS TIME (MASK)

Measurement Procedure

| Step | Description |
|--|---|
| 1. Set the measurement mode MEASURE [Power vs Time] [Power vs Time (Mask)] | Press the MEASURE hot key. Press the Power vs Time soft key. Press the Power vs Time (Mask) soft key. |
| 2. Set the measurement parameters MEASURE SETUP [Spread Factor] [DL Auto], [UL Auto], [SF1], [SF2], [SF4], [SF8], or [SF16] [Max User] Enter a value [Enter] or ENTER [Slot Number] | Press the MEASURE SETUP hot key. Press the Spread Factor soft key. Press the soft key to choose. Press the Max User soft key to set the maximum number. Use the numeric keys to input an even number. Press the Enter soft key or the ENTER hard key. Press the Slot Number soft key. |

[TS0], [TS1], [TS2], [TS3],
[TS4], [TS5], or [TS6]

Press one of the soft keys to select the time slot number.

TD-SCDMA Power vs Time (Mask) Measurement Procedure

MEASURE SETUP



- n **SPREAD FACTOR:** Sets the spread factor by selecting among **DL Auto** (Auto detection for Downlink), **UL Auto** (Auto detection for Uplink), **SF1**, **SF2**, **SF4**, **SF8**, and **SF16**.
- n **MAX USER:** Sets the number of users up to 16. The number must be an even number. Use the numeric keys to input value and press the **Enter** soft key to complete the input.
- n **SLOT NUMBER:** Sets the time slot number to be displayed on the measurement screen. Select the slot number among **TS0**, **TS1**, **TS2**, **TS3**, **TS4**, **TS5** and **TS6**.
- n **DELAY:** Sets the delay in micro seconds. This key is used only when there is a time offset in the signals to be measured.
- n **MISCELLANEOUS**
 - Y **DETECT MODE:** Sets the modulation type to **Auto**, **QPSK/8PSK**, **QPSK**, **8PSK**, or **16QAM**.
 - Y **SCRAMBLE:** Sets the type of detecting method to determine scrambling estimation.
 - **SPEC:** Searches based on TD-SCDMA specification. Searches “Sync Sequence Number” from 0 to 31 and determines “Scrambling Code Number” using sync sequence number.
 - **FULL:** Fully searches “Scrambling Code Number” from 0 to 127.
 - Y **MID SF MAP:** Sets the type of detecting method to determine Midamble spreading factor estimation either in full search or maximum power search.
 - **MAX:** Determines spread factor of Midamble using the maximum power of received Midamble.
 - **SPEC:** Searches based on TD-SCDMA specification, “Default Midamble Allocation”.

Setting Limit

LIMIT



This hot key is used to set the threshold value for the limit line on the display screen. It turns on or off the limit or band limit settings of the measurement for pass/fail indication. The user input window must be inactive first to get the Limit hot key function other than the number input.

| Step | Description |
|--|--|
| <p>1. Select the limit</p> <p>LIMIT</p> <p>[PvsT Test Limits]</p> <p>[Slot Power]</p> <p>[Test Limits]</p> <p><On> or <Off></p> <p>[High Limit]</p> <p>Enter a value</p> <p>[dBm] or ENTER</p> <p>[Low Limit]</p> <p>Enter a value</p> <p>[dBm] or ENTER</p> <p>[On/Off Ratio]</p> <p>[Test Limits]</p> <p><On> or <Off></p> <p>[High Limit]</p> <p>Enter a value</p> <p>[dB] or ENTER</p> <p>[Low Limit]</p> <p>Enter a value</p> <p>[dB] or ENTER</p> | <p>Press the LIMIT hot key.</p> <p>Press the PvsT Test Limits soft key.</p> <p>Press the Slot Power soft key.</p> <p>Press the Test Limits soft key to toggle between On and Off and select one.</p> <p>Press the High Limit soft key to set the upper limit of the Pass/Fail criteria. Use the numeric keys to input value.</p> <p>Press the unit soft key or the ENTER hard key.</p> <p>Press the Low Limit soft key to set the lower limit of the Pass/Fail criteria. Use the numeric keys to input value.</p> <p>Press the unit soft key or the ENTER hard key.</p> <p>Press the On/Off Ratio soft key.</p> <p>Press the Test Limits soft key to toggle between On and Off and select one.</p> <p>Press the High Limit soft key to set the upper limit of the Pass/Fail criteria. Use the numeric keys to input value.</p> <p>Press the unit soft key or the ENTER hard key.</p> <p>Press the Low Limit soft key to set the lower limit of the Pass/Fail criteria. Use the numeric keys to input value.</p> <p>Press the unit soft key or the ENTER hard key.</p> |
| <p>2. Enable beep</p> <p>LIMIT</p> <p>[Beep]</p> <p><On> or <Off></p> | <p>Press the LIMIT hot key.</p> <p>Press the Beep soft key to toggle between On and Off and select one. This will make audible alarm if the measurement result goes beyond the limit.</p> |

- n **SLOT POWER:** Sets limits of the power of the slots.
- Y **TEST LIMITS:** Enables or disables Pass/Fail results on the display screen. Toggle the **Test Limits** soft key to set it to **On** or **Off**.
- Y **HIGH LIMIT:** Sets the upper limit of the Pass/Fail criteria. Use the numeric keys to enter a threshold or limit value and press the **dBm** unit soft key or the **ENTER** hard key to complete the input.
- Y **LOW LIMIT:** Sets the lower limit of the Pass/Fail criteria. Use the numeric keys to enter a threshold or limit value and press the **dBm** unit soft key or the **ENTER** hard key to complete the input.
- n **DwPTS POWER:** *This key is not used in this measurement.*
- n **UpPTS POWER:** *This key is not used in this measurement.*
- n **ON/OFF RATIO:** Sets limits of the ratio of the power between on and off portions of the Downlink

slots.

- Y **TEST LIMITS:** Enables or disables Pass/Fail results on the display screen. Toggle the **Test Limits** soft key to set it to **On** or **Off**.
- Y **HIGH LIMIT:** Sets the upper limit of the Pass/Fail criteria. Use the numeric keys to enter a threshold or limit value and press the **dB** unit soft key or the **ENTER** hard key to complete the input.
- Y **LOW LIMIT:** Sets the lower limit of the Pass/Fail criteria. Use the numeric keys to enter a threshold or limit value and press the **dB** unit soft key or the **ENTER** hard key to complete the input.

Measurement Example

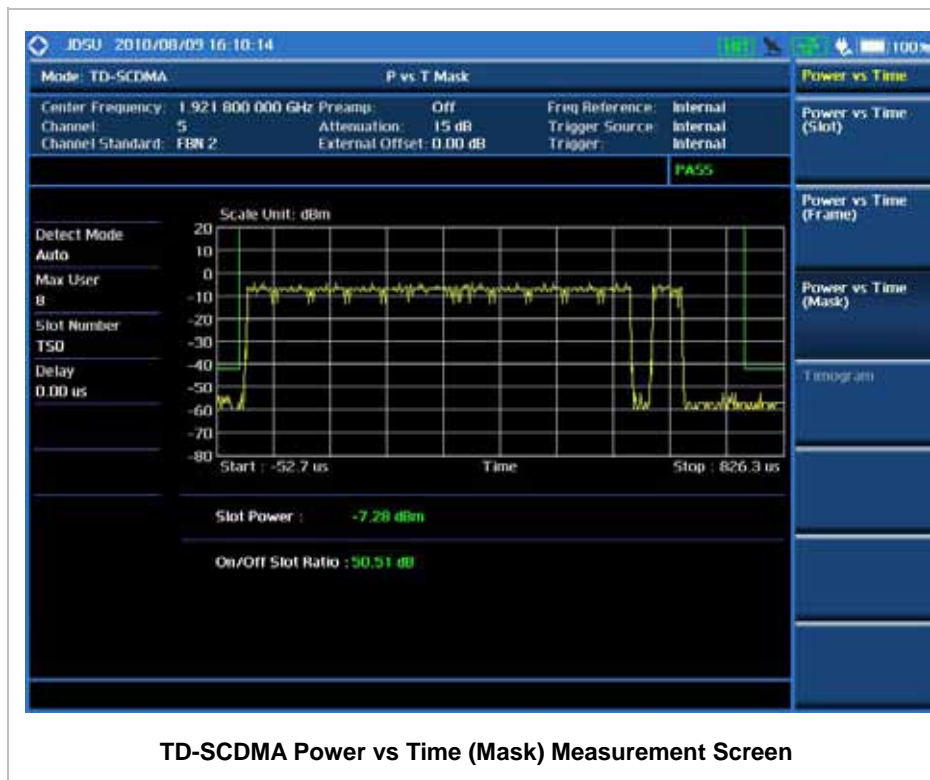

TIMOGRAM

Measurement Procedure

| Step | Description |
|------|--------------------------|
| 1. | Set the measurement mode |

| | |
|--|---|
| <p>MEASURE [Power vs Time] [Timogram]</p> | <p>Press the MEASURE hot key. Press the Power vs Time soft key. Press the Timogram soft key.</p> |
| <p>2. Set the measurement parameters MEASURE SETUP [Spread Factor] [DL Auto], [UL Auto], [SF1], [SF2], [SF4], [SF8], or [SF16]</p> <p>[Max User] Enter a value [Enter] or ENTER</p> <p>[Time Interval] Enter a value [Enter] or ENTER</p> <p>[Auto Save] <On> or <Off></p> | <p>Press the MEASURE SETUP hot key. Press the Spread Factor soft key. Press the soft key to choose.</p> <p>Press the Max User soft key to set the maximum number. Use the numeric keys to input an even number. Press the Enter soft key or the ENTER hard key.</p> <p>Press the Time Interval soft key. Use the numeric keys to input value in sec. Press the Enter soft key or the ENTER hard key.</p> <p>Press the Auto Save soft key. Toggle between On and Off.</p> |
| <p>3. Analyze the measurement result [Time Cursor] <On> or <Off></p> | <p>Press the Time Cursor soft key. Toggle between On and Off.</p> |

TD-SCDMA Timogram Measurement Procedure

MEASURE SETUP



- n **RESET/RESTART:** Restarts the measurement.
- n **AUTO SAVE:** Enables or disables automatic saving of the measurement data to an external USB memory. When it turns on, the measurements will be recorded into the default file (codogram.cod) or a user-named file.
- n **TIME CURSOR:** Enables or disables the time cursor indicator. When the time cursor is enabled after specifying a number, measurement is put on hold and information of the specific number is updated on the measurement screen.
- n **TIME INTERVAL:** Sets the time interval in sec. Use the numeric keys to enter a value and press the **Enter** soft key or the **ENTER** hard key to complete to the input. 0 is the fastest measurement speed. As the time interval gets larger, the measurement speed is reduced.
- n **SPREAD FACTOR:** Sets the spread factor by selecting among **DL Auto** (Auto detection for Downlink), **UL Auto** (Auto detection for Uplink), **SF1, SF2, SF4, SF8, and SF16**.
- n **MAX USER:** Sets the number of users up to 16. The number must be an even number. Use the numeric keys to input value and press the **Enter** soft key to complete the input.

n MISCELLANEOUS

- Y **DELAY:** Sets the delay in micro seconds. This key is used only when there is a time offset in the signals to be measured.
- Y **DETECT MODE:** Sets the modulation type to **Auto**, **QPSK/8PSK**, **QPSK**, **8PSK**, or **16QAM**.
- Y **SCRAMBLE:** Sets the type of detecting method to determine scrambling estimation.
 - **SPEC:** Searches based on TD-SCDMA specification. Searches Sync Sequence Number from 0 to 31 and determines Scrambling Code Number using sync sequence number.
 - **FULL:** Fully searches "Scrambling Code Number" from 0 to 127.
- Y **MID SF MAP:** Sets the type of detecting method to determine Midamble spreading factor estimation either in full search or maximum power search.
 - **MAX:** Determines spread factor of Midamble using the maximum power of received Midamble.
 - **SPEC:** Searches based on TD-SCDMA specification, Default Midamble Allocation.

Measurement Example



TD-SCDMA Timogram Measurement Screen

MODULATION ANALYSIS MEASUREMENTS

TD-SCDMA receivers rely on the frequency or phase quality of the QPSK or 8-PSK signal in order to achieve the expected carrier to noise performance. A transmitter with high frequency or phase error is often still able to support phone calls during a functional test. This measurement displays the frequency errors numerically and graphically, showing the binary representation of the demodulated data bits of the received signal using Constellation, Midamble Power, Code Power, and Code Error screens.

Modulation Analysis in TD-SCDMA Signal Analyzer provides single-button measurements for the following essential measurements.

- n Constellation
- n Midamble Power
- n Code Power
- n Code Error

Setting Mode

| Step | Description |
|--|---|
| 1. Connect the cable | Connect a cable directly or indirectly as shown in the section Connecting a Cable on page 7 of this chapter. |
| 2. Select the mode MODE [Signal Analyzer] [More (1/2)] [TD-SCDMA] [Modulation Analysis] [Constellation], [Midamble Power], [Code Power], or [Code Error] | Press the MODE hard key. Press the Signal Analyzer soft key. Press the More (1/2) soft key to get more soft keys. Press the TD-SCDMA soft key. Press the Modulation Analysis soft key. Press one of the measurement mode soft keys to select. |

Setting Frequency

| Step | Description |
|--|--|
| <p>1. Set the frequency</p> <p>FREQ/DIST</p> <p>[Unit]</p> <p><Freq> or <Channel></p> <p><i>When Freq is selected:</i></p> <p>[Center Frequency]</p> <p>Enter a value</p> <p>[GHz], [MHz], [kHz], or [Hz]</p> <p><i>When Channel is selected:</i></p> <p>[Channel Standard]</p> <p>Select a channel standard</p> <p>[Select] or ENTER</p> <p>[Channel Number]</p> <p>Enter a value</p> <p>[Forward]</p> | <p>Press the FREQ/DIST hard key.</p> <p>Press the Unit soft key. Toggle this key between Freq and Channel. A set of Freq/Dist screen menu changes accordingly.</p> <p>Press the Center Frequency soft key.</p> <p>Use the numeric keys, the rotary knob, or the arrow keys.</p> <p>When using the numeric keys, the input is completed by selecting one of the unit soft keys.</p> <p>Press the Channel Standard soft key.</p> <p>Press the arrow keys, rotate the knob, or press the Page Up and Page Down soft keys to highlight a frequency band to select.</p> <p>Press the Select soft key or the ENTER hard key.</p> <p>Press the Channel Number soft key.</p> <p>Use the numeric keys to input value and press the Forward soft key to complete the input. The instrument automatically displays its corresponding center frequency value for the channel number.</p> |

FREQ/DIST 

- n **UNIT:** Determines the way how to set the frequency band either with standard band or custom frequency band. Toggling this key between **Freq** and **Channel** changes a set of Freq/Dist screen menu automatically.
- n **CENTER FREQUENCY:** Changes the center frequency setting. Use the rotary knob or the arrow keys. Or use the numeric keys to input a certain value and press one of the unit soft keys to complete the input.
- n **FREQUENCY STEP:** Defines the amount of frequency to be increased or decreased when using the rotary knob or the arrow keys to change the **Center Frequency**. This frequency step size can be entered by using numeric keys and the unit soft keys.
- n **CHANNEL NUMBER:** Enters a channel number. The instrument automatically displays its corresponding center frequency value for the channel number.
- n **CHANNEL STEP:** Defines the amount of channel to be increased or decreased when using the

rotary knob or the arrow keys to change the **Channel Number**. This channel step size can be entered by using numeric keys and the **Enter** soft key.

- n **CHANNEL STANDARD:** When the channel standard is selected from the list, the center frequency information on the display screen will be mapped accordingly to the selected channel standard. The channel standards available in the instrument are listed in the table in the Appendix C – Band, Frequency & Channel Standard.

Setting Amplitude

| Step | Description |
|--|---|
| 1. Set the reference/attenuation level AMP/SCALE [Auto Scale] or [Reference Level] Enter a reference level value [dBm] or ENTER [Attenuation] <Manual> Enter an attenuation value | Press the AMP/SCALE hard key. Press the Auto Scale soft key to automatically set optimum levels of reference and attenuation. Press the Reference Level soft key to set manually. Use the numeric keys or the rotary knob that changes in a 10 dB step. Press the dBm soft key or the ENTER hard key. Press the Attenuation soft key. The Auto mode is set by default. This key toggles between the Auto and Manual . Press the Attenuation soft key to highlight the Manual mode and change the attenuation value to optimize S/N. Use the numeric keys or the rotary knob that changes in a 5 dB step. The attenuation setting range is 0 to 50 dB. |

AMP/SCALE



- n **AUTO SCALE:** The instrument can automatically set the scale to the minimum and maximum values on the Y-axis of the graph for optimum display of the traces measured. Each time the **Auto Scale** is selected, the top and bottom scales are set to the minimum and maximum values with margin on the Y-axis of the display screen.
- n **REFERENCE:** Sets the display of measurement result to relative or absolute value. Toggle between **Abs** for absolute and **Rel** for relative. *This key is not used in the Constellation mode.*
 - Y **ABS:** The code domain power is measured absolute to channel power.
 - Y **REL:** The code domain power is measured relative to channel power.

- n **REFERENCE LEVEL:** Sets the maximum Y-axis range. This key is activated only when the **Reference** is set to **Abs** mode. *This key is not used in the Constellation mode.*
- n **ATTENUATION**
 - Y **AUTO:** Input attenuator's value is automatically set depending on the reference level. This is the default operation mode, so it is recommended to use this mode unless a special measurement condition is needed.
 - Y **MANUAL:** Sets the attenuator's value for the **Spectrum Analyzer RF In 50 Ω** port.
- n **PREAMP:** Turns on or off the internal pre-amplifier. Preamp results in a correction being applied to compensate for the gain of the preamp so that amplitude readings show the value at the input connector. This soft key toggles between the **On** and **Off**. When it is set to **On**, the allowable attenuation input range is from 0 dB to 10 dB in a multiple of 5. If the attenuation value is manually set greater than 10 dB, the instrument will automatically turn off the pre-amplifier to display low level signal properly on the screen.
- n **EXTERNAL OFFSET:** Sets an external offset value. An offset consists of a cable loss and a user offset and the measurement result shows the value reflecting both offset values. When the external offset value is set at 40 dB in the Spectrum mode, the measurement result compensates 40 dB at both the Spectrum Analyzer and Signal Analyzer modes.

Setting Sweep Mode



This hot key is used to set the sweep parameters. The user input window must be inactive first to get the Sweep hot key function other than the number input.

- n **SWEEP MODE:** Sets the sweep method. Toggle between **Continue** and **Single**.

| Step | Description |
|--|---|
| 1. Set the sweep mode SWEEP [Sweep Mode] | Press the SWEEP hot key. Press the Sweep Mode soft key. Toggle between Continue and Single . |

Setting External Clock

To enhance the reliability of modulation analysis measurements the JD740A series must be synchronized with the Base Station. When an external clock is not supplied, the JD740A series works with a built-in internal high-accuracy time base. In this case, some measurement results may exhibit inaccurate values. Therefore, it is highly recommended to use the same reference clock as signal

source. Trigger mode can be changed by using the **TRIGGER** hot key.

EXTERNAL CLOCK OPERATING STANDARDS

| Clock | Type | Reference | Port | Switching Standard |
|--------------------|----------|--------------------|---------------|--|
| External Reference | Internal | Internal 10 MHz | | Default |
| | External | External Ref Clock | Ext Ref (SMA) | Manual switching (Input signal level >-3 dBm) |
| | GPS | GPS Clock | GPS (SMA) | Automatic switching (GPS signal received) |
| Trigger | Internal | Internal Trigger | | Default |
| | External | External Trigger | Trigger (SMA) | Manual switching |
| | GPS | GPS | GPS (SMA) | Manual switching |

CONNECTION

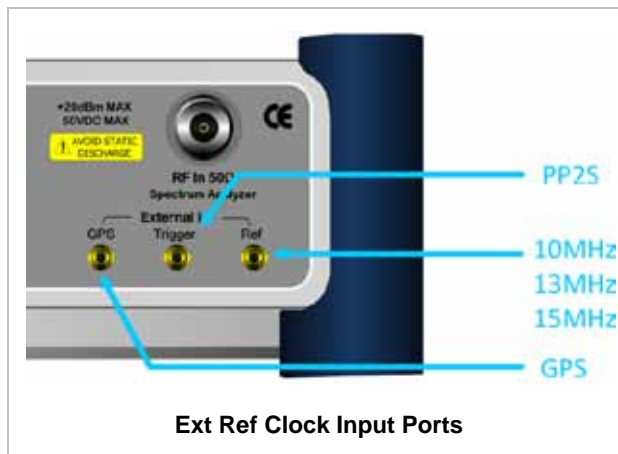

ENABLING EXTERNAL REFERENCE

| Step | Description |
|---|--|
| 1. Connect an external reference | Connect one of the external references or a GPS antenna to the JD740A series. |
| 2. Change reference clock SYSTEM [Frequency Reference] [External 10 MHz], [External 13 MHz], [External 15 MHz] or | Press the SYSTEM hot key. Press the Frequency Reference soft key to select one of the external reference clocks or GPS. Press one of the soft keys to choose among External 10 MHz , External 13 MHz , External 15 MHz , and GPS . |

| | |
|-------|--|
| [GPS] | |
|-------|--|

EXTERNAL REFERENCE INDICATOR INFORMATION

Each indicator tells different locking status according to a connection. When a GPS antenna is connected, longitude and latitude information will be displayed on the screen.

| Type | Indicator | Description |
|----------|--|----------------------------------|
| Internal |  (Green) | Locked |
| External |  (Green) | Locked |
| |  (Red) | Unlocked |
| GPS |  (Green) | Locked |
| |  (Yellow) | Locking in progress |
| |  (Gray) | Unable to lock or antenna failed |

CONSTELLATION

The Constellation is used to analyze transmitter modulation performance. The JD740A series displays the constellation diagram with modulation metrics.

Measurement Procedure

| Step | Description |
|--|--|
| 1. Set the measurement mode MEASURE [Modulation Analysis] [Constellation] | Press the MEASURE hot key. Press the Modulation Analysis soft key. Press the Constellation soft key. |
| 2. Set the measurement parameters MEASURE SETUP [Scramble] <Auto> or <Manual> [Spread Factor] [DL Auto], [UL Auto], [SF1], [SF2], [SF4], [SF8], or [SF16] | Press the MEASURE SETUP hot key. Press the Scramble soft key. The Auto mode is set by default. Toggle between Auto and Manual . Press the Spread Factor soft key. Press the soft key to choose. |

| | |
|--|--|
| <p>[Max User] Enter a value [Enter] or ENTER</p> | <p>Press the Max User soft key to set the maximum number. Use the numeric keys to input an even number. Press the Enter soft key or the ENTER hard key.</p> |
| <p>[Slot Number] [TS0], [TS1], [TS2], [TS3], [TS4], [TS5], or [TS6]</p> | <p>Press the Slot Number soft key. Press one of the soft keys to select the time slot number.</p> |

TD-SCDMA Constellation Measurement Procedure

MEASURE SETUP



- n **SCRAMBLE:** Sets the scramble code to **Auto** or **Manual**. Toggle between **Auto** and **Manual**. To change the value in the **Manual** mode, use the numeric keys to enter a value between 0 and 511 and press the **Enter** soft key or the **ENTER** hard key to complete the input.
- n **SPREAD FACTOR:** Sets the spread factor by selecting among **DL Auto**, **UL Auto**, **SF1**, **SF2**, **SF4**, **SF8**, and **SF16**.
- n **MAX USER:** Sets the number of users up to 16. The number must be an even number. Use the numeric keys to input value and press the **Enter** soft key to complete the input.
- n **SLOT NUMBER:** Sets the time slot number to be displayed on the measurement screen. Select the slot number among **TS0**, **TS1**, **TS2**, **TS3**, **TS4**, **TS5** and **TS6**.
- n **MISCELLANEOUS**
 - Y **DELAY:** Sets the delay in micro seconds. This key is used only when there is a time offset in the signals to be measured.
 - Y **SCRAMBLE:** Sets the type of detecting method to determine scrambling estimation.
 - **SPEC:** Searches based on TD-SCDMA specification. Searches “Sync Sequence Number” from 0 to 31 and determines “Scrambling Code Number” using sync sequence number.
 - **FULL:** Fully searches “Scrambling Code Number” from 0 to 127.
 - Y **MID SF MAP:** Sets the type of detecting method to determine Midamble spreading factor estimation either in full search or maximum power search.
 - **MAX:** Determines spread factor of Midamble using the maximum power of received Midamble.
 - **SPEC:** Searches based on TD-SCDMA specification, “Default Midamble Allocation”.
 - Y **DETECT MODE:** Sets the modulation type to **Auto**, **QPSK/8PSK**, **QPSK**, **8PSK**, or **16QAM**.

- Y **TRHESHOLD:** Sets the relative threshold value. Its default setting is -27 dB. To change the value, use the numeric keys to enter a value between -50 and 0 and press the **Enter** soft key or the **ENTER** hard key to complete to the input.

Setting Limit



This hot key is used to set the threshold value for the limit line on the display screen. It turns on or off the limit or band limit settings of the measurement for pass/fail indication. The user input window must be inactive first to get the Limit hot key function other than the number input.

| Step | Description |
|---|--|
| 1. Select the limit LIMIT [Modulation Test Limits] [Frequency Error] [Test Limits] <On> or <Off> [High Limit] [Low Limit] [EVM RMS] [Test Limit] <On> or <Off> [High Limit] [PCDE] [Test Limit] <On> or <Off> [High Limit] | Press the LIMIT hot key. Press the Modulation Test Limits soft key. Press the Frequency Error soft key. Press the Test Limits soft key. Toggle between On and Off . Use the numeric keys and input a number in ppm. Use the numeric keys and input a number in ppm. Press the EVM RMS soft key. Press the Test Limit soft key. Toggle between On and Off . Use the numeric keys and input a number in %. Press the PCDE soft key. Press the Test Limit soft key. Toggle between On and Off . Use the numeric keys and input a number in dB. |
| 2. Enable beep LIMIT [Beep] <On> or <Off> | Press the LIMIT hot key. Press the Beep soft key to toggle between On and Off and select one. This will make audible alarm if the measurement result goes beyond the limit. |

- n **FREQUENCY ERROR:** Sets the frequency error limit.
- Y **TEST LIMITS:** Enables or disables the test limit(s). Toggle the **Test Limits** soft key between **On** and **Off**.
- Y **HIGH LIMIT:** Sets the upper limit. Use the numeric keys to input value and press the unit soft

- key or the **ENTER** hard key to complete the input.
- Y **LOW LIMIT:** Sets the lower limit. Use the numeric keys to input value and press the unit soft key or the **ENTER** hard key to complete the input.
- n **EVM RMS:** Sets the error vector magnitude rms limit.
- Y **TEST LIMIT:** Enables or disables the test limit(s). Toggle the **Test Limit** soft key between **On** and **Off**.
- Y **HIGH LIMIT:** Sets the upper limit. Use the numeric keys to input value and press the **Enter** soft key or the **ENTER** hard key to complete the input.
- n **PCDE:** Sets the peak code domain error limit.
- Y **TEST LIMIT:** Enables or disables the test limit(s). Toggle the **Test Limit** soft key between **On** and **Off**.
- Y **HIGH LIMIT:** Sets the upper limit. Use the numeric keys to input value and press the unit soft key or the **ENTER** hard key to complete the input.
- n **MAX INACTIVE:** *This key is not used in the Constellation mode.*

Measurement Example

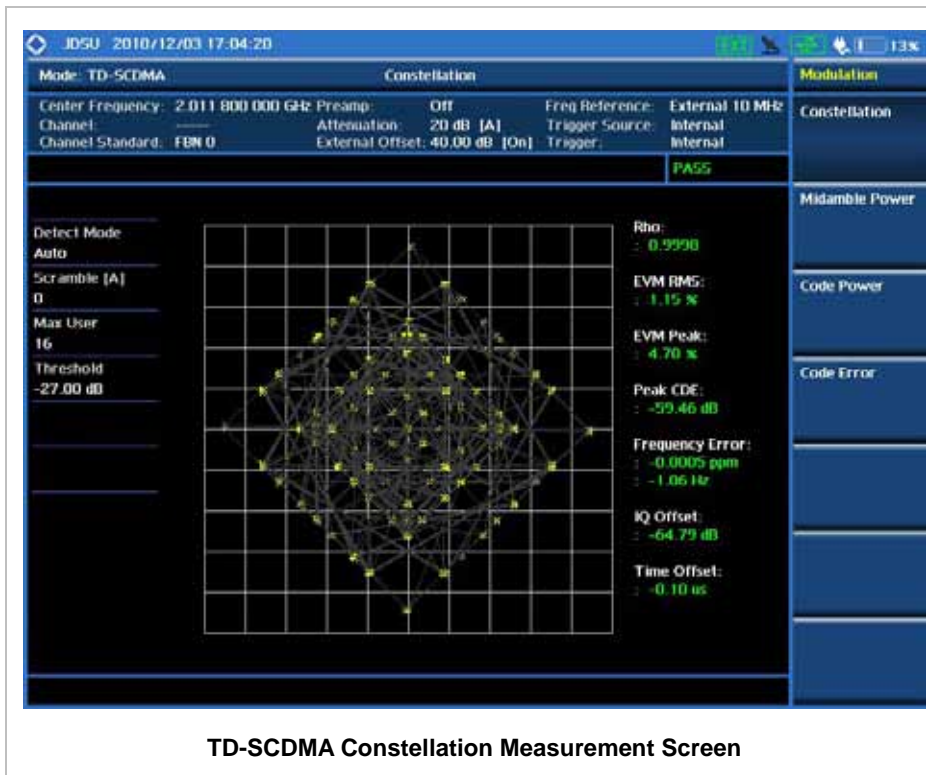

MIDAMBLE POWER

Measurement Procedure

| Step | Description |
|---|---|
| 1. Set the measurement mode MEASURE [Modulation Analysis] [Midamble Power] | Press the MEASURE hot key. Press the Modulation Analysis soft key. Press the Midamble Power soft key. |
| 2. Set the measurement parameters MEASURE SETUP [Scramble] <Auto> or <Manual> [Spread Factor] [DL Auto], [UL Auto], [SF1], [SF2], [SF4], [SF8], or [SF16] [Max User] Enter a value [Enter] or ENTER [Slot Number] [TS0], [TS1], [TS2], [TS3], [TS4], [TS5], or [TS6] | Press the MEASURE SETUP hot key. Press the Scramble soft key. The Auto mode is set by default. Toggle between Auto and Manual . Press the Spread Factor soft key. Press the soft key to choose. Press the Max User soft key to set the maximum number. Use the numeric keys to input an even number. Press the Enter soft key or the ENTER hard key. Press the Slot Number soft key. Press one of the soft keys to select the time slot number. |

TD-SCDMA Midamble Power Measurement Procedure

MEASURE SETUP



- n **SCRAMBLE:** Sets the scramble code to **Auto** or **Manual**. Toggle between **Auto** and **Manual**. To change the value in the **Manual** mode, use the numeric keys to enter a value between 0 and 511 and press the **Enter** soft key or the **ENTER** hard key to complete the input.
- n **SPREAD FACTOR:** Sets the spread factor by selecting among **DL Auto**, **UL Auto**, **SF1**, **SF2**, **SF4**, **SF8**, and **SF16**.
- n **MAX USER:** Sets the number of users up to 16. The number must be an even number. Use the numeric keys to input value and press the **Enter** soft key to complete the input.
- n **SLOT NUMBER:** Sets the time slot number to be displayed on the measurement screen. Select the slot number among **TS0**, **TS1**, **TS2**, **TS3**, **TS4**, **TS5** and **TS6**.
- n **MISCELLANEOUS**

- Y **DELAY:** Sets the delay in micro seconds. This key is used only when there is a time offset in the signals to be measured.
- Y **SCRAMBLE:** Sets the type of detecting method to determine scrambling estimation.
 - **SPEC:** Searches based on TD-SCDMA specification. Searches “Sync Sequence Number” from 0 to 31 and determines “Scrambling Code Number” using sync sequence number.
 - **FULL:** Fully searches “Scrambling Code Number” from 0 to 127.
- Y **MID SF MAP:** Sets the type of detecting method to determine Midamble spreading factor estimation either in full search or maximum power search.
 - **MAX:** Determines spread factor of Midamble using the maximum power of received Midamble.
 - **SPEC:** Searches based on TD-SCDMA specification, “Default Midamble Allocation”.
- Y **DETECT MODE:** Sets the modulation type to **Auto**, **QPSK/8PSK**, **QPSK**, **8PSK**, or **16QAM**.
- Y **TRHESHOLD:** Sets the relative threshold value. Its default setting is -27 dB. To change the value, use the numeric keys to enter a value between -50 and 0 and press the **Enter** soft key or the **ENTER** hard key to complete to the input.

Measurement Example

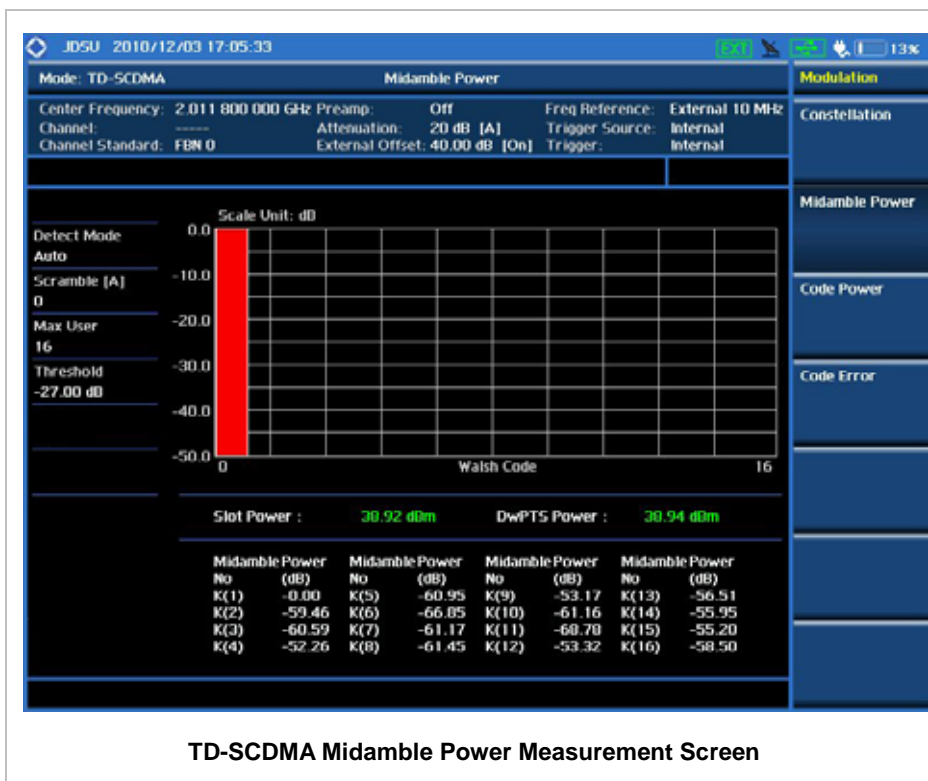

CODE POWER

Measurement Procedure

| Step | Description |
|---|---|
| 1. Set the measurement mode MEASURE [Modulation Analysis] [Code Power] | Press the MEASURE hot key. Press the Modulation Analysis soft key. Press the Code Power soft key. |
| 2. Set the measurement parameters MEASURE SETUP [Scramble] <Auto> or <Manual> [Spread Factor] [DL Auto], [UL Auto], [SF1], [SF2], [SF4], [SF8], or [SF16] [Max User] Enter a value [Enter] or ENTER [Slot Number] [TS0], [TS1], [TS2], [TS3], [TS4], [TS5], or [TS6] | Press the MEASURE SETUP hot key. Press the Scramble soft key. The Auto mode is set by default. Toggle between Auto and Manual . Press the Spread Factor soft key. Press the soft key to choose. Press the Max User soft key to set the maximum number. Use the numeric keys to input an even number. Press the Enter soft key or the ENTER hard key. Press the Slot Number soft key. Press one of the soft keys to select the time slot number. |

TD-SCDMA Code Power Measurements Procedure

MEASURE SETUP



- n **SCRAMBLE:** Sets the scramble code to **Auto** or **Manual**. Toggle between **Auto** and **Manual**. To change the value in the **Manual** mode, use the numeric keys to enter a value between 0 and 511 and press the **Enter** soft key or the **ENTER** hard key to complete to the input.
- n **SPREAD FACTOR:** Sets the spread factor by selecting among **DL Auto**, **UL Auto**, **SF1**, **SF2**, **SF4**, **SF8**, and **SF16**.
- n **MAX USER:** Sets the number of users up to 16. The number must be an even number. Use the numeric keys to input value and press the **Enter** soft key to complete the input.
- n **SLOT NUMBER:** Sets the time slot number to be displayed on the measurement screen. Select the slot number among **TS0**, **TS1**, **TS2**, **TS3**, **TS4**, **TS5** and **TS6**.

n **MISCELLANEOUS**

- Y **DELAY:** Sets the delay in micro seconds. This key is used only when there is a time offset in the signals to be measured.
- Y **SCRAMBLE:** Sets the type of detecting method to determine scrambling estimation.
 - **SPEC:** Searches based on TD-SCDMA specification. Searches “Sync Sequence Number” from 0 to 31 and determines “Scrambling Code Number” using sync sequence number.
 - **FULL:** Fully searches “Scrambling Code Number” from 0 to 127.
- Y **MID SF MAP:** Sets the type of detecting method to determine Midamble spreading factor estimation either in full search or maximum power search.
 - **MAX:** Determines spread factor of Midamble using the maximum power of received Midamble.
 - **SPEC:** Searches based on TD-SCDMA specification, “Default Midamble Allocation”.
- Y **DETECT MODE:** Sets the modulation type to **Auto**, **QPSK/8PSK**, **QPSK**, **8PSK**, or **16QAM**.
- Y **TRHESHOLD:** Sets the relative threshold value. Its default setting is -27 dB. To change the value, use the numeric keys to enter a value between -50 and 0 and press the **Enter** soft key or the **ENTER** hard key to complete to the input.

Setting Limit



This hot key is used to set the threshold value for the limit line on the display screen. It turns on or off the limit or band limit settings of the measurement for pass/fail indication. The user input window must be inactive first to get the Limit hot key function other than the number input.

| Step | Description |
|---|--|
| 1. Select the limit LIMIT [Modulation Test Limits] [Max Inactive] [Test Limit] <On> or <Off> [High Limit] | Press the LIMIT hot key. Press the Modulation Test Limits soft key. Press the Max Inactive soft key. Press the Test Limit soft key. Toggle between On and Off . Use the numeric keys and input a number in dB. |
| 2. Enable beep LIMIT | Press the LIMIT hot key. |

| | |
|--|--|
| <p>[Beep] <On> or <Off></p> | <p>Press the Beep soft key to toggle between On and Off and select one. This will make audible alarm if the measurement result goes beyond the limit.</p> |
|--|--|

- n **FREQUENCY ERROR:** This key is not used in the Code Power mode.
- n **EVM RMS:** This key is not used in the Code Power mode.
- n **PCDE:** This key is not used in the Code Power mode.
- n **MAX INACTIVE:** Sets the limit of the highest level among inactive channels.
- Y **TEST LIMIT:** Enables or disables the test limit. Toggle the **Test Limit** soft key between **On** and **Off**.
- Y **HIGH LIMIT:** Sets the upper limit. Use the numeric keys to input value and press the unit soft key or the **ENTER** hard key to complete the input.

Measurement Example



TD-SCDMA Code Power Measurement Screen

CODE ERROR

Measurement Procedure

| Step | Description |
|--|---|
| 1. Set the measurement mode MEASURE [Modulation Analysis] [Code Error] | Press the MEASURE hot key. Press the Modulation Analysis soft key. Press the Code Error soft key. |
| 2. Set the measurement parameters MEASURE SETUP [Scramble] <Auto> or <Manual> [Spread Factor] [DL Auto], [UL Auto], [SF1], [SF2], [SF4], [SF8], or [SF16] [Max User] Enter a value [Enter] or ENTER [Slot Number] [TS0], [TS1], [TS2], [TS3], [TS4], [TS5], or [TS6] | Press the MEASURE SETUP hot key. Press the Scramble soft key. The Auto mode is set by default. Toggle between Auto and Manual . Press the Spread Factor soft key. Press the soft key to choose. Press the Max User soft key to set the maximum number. Use the numeric keys to input an even number. Press the Enter soft key or the ENTER hard key. Press the Slot Number soft key. Press one of the soft keys to select the time slot number. |

TD-SCDMA Code Error Measurements Procedure

MEASURE SETUP



- n **SCRAMBLE:** Sets the scramble code to **Auto** or **Manual**. Toggle between **Auto** and **Manual**. To change the value in the **Manual** mode, use the numeric keys to enter a value between 0 and 511 and press the **Enter** soft key or the **ENTER** hard key to complete to the input.
- n **SPREAD FACTOR:** Sets the spread factor by selecting among **DL Auto**, **UL Auto**, **SF1**, **SF2**, **SF4**, **SF8**, and **SF16**.
- n **MAX USER:** Sets the number of users up to 16. The number must be an even number. Use the numeric keys to input value and press the **Enter** soft key to complete the input.
- n **SLOT NUMBER:** Sets the time slot number to be displayed on the measurement screen. Select the slot number among **TS0**, **TS1**, **TS2**, **TS3**, **TS4**, **TS5** and **TS6**.

n **MISCELLANEOUS**

- Y **DELAY:** Sets the delay in micro seconds. This key is used only when there is a time offset in the signals to be measured.
- Y **SCRAMBLE:** Sets the type of detecting method to determine scrambling estimation.
 - **SPEC:** Searches based on TD-SCDMA specification. Searches “Sync Sequence Number” from 0 to 31 and determines “Scrambling Code Number” using sync sequence number.
 - **FULL:** Fully searches “Scrambling Code Number” from 0 to 127.
- Y **MID SF MAP:** Sets the type of detecting method to determine Midamble spreading factor estimation either in full search or maximum power search.
 - **MAX:** Determines spread factor of Midamble using the maximum power of received Midamble.
 - **SPEC:** Searches based on TD-SCDMA specification, “Default Midamble Allocation”.
- Y **DETECT MODE:** Sets the modulation type to **Auto**, **QPSK/8PSK**, **QPSK**, **8PSK**, or **16QAM**.
- Y **TRHESHOLD:** Sets the relative threshold value. Its default setting is -27 dB. To change the value, use the numeric keys to enter a value between -50 and 0 and press the **Enter** soft key or the **ENTER** hard key to complete to the input.

Setting Limit



This hot key is used to set the threshold value for the limit line on the display screen. It turns on or off the limit or band limit settings of the measurement for pass/fail indication. The user input window must be inactive first to get the Limit hot key function other than the number input.

| Step | Description |
|---|--|
| 1. Select the limit LIMIT [Modulation Test Limits] [Max Inactive] [Test Limit] <On> or <Off> [High Limit] | Press the LIMIT hot key. Press the Modulation Test Limits soft key. Press the Max Inactive soft key. Press the Test Limit soft key. Toggle between On and Off . Use the numeric keys and input a number in dB. |
| 2. Enable beep LIMIT | Press the LIMIT hot key. |

| | |
|--|--|
| <p>[Beep] <On> or <Off></p> | <p>Press the Beep soft key to toggle between On and Off and select one. This will make audible alarm if the measurement result goes beyond the limit.</p> |
|--|--|

- n **FREQUENCY ERROR:** This key is not used in the Code Error mode.
- n **EVM RMS:** This key is not used in the Code Error mode.
- n **PCDE:** This key is not used in the Code Error mode.
- n **MAX INACTIVE:** Sets the limit of the highest level among inactive channels.
- Y **TEST LIMIT:** Enables or disables the test limit. Toggle this soft key between **On** and **Off**.
- Y **HIGH LIMIT:** Sets the upper limit. Use the numeric keys to input value and press the unit soft key or the **ENTER** hard key to complete the input.

Measurement Example



TD-SCDMA Code Error Measurement Screen (Fail)

AUTO MEASUREMENT

The Auto Measure function of the JD740A series allows a complete signal profiling covering RF

characterization and modulation quality parameters of up to 10 different carriers, particularly useful on an overlay architecture where base stations are transmitting in different frequencies.

The Auto Measure can be easily executed either by selecting a menu in the instrument or by running a programmed scenario in the PC-based application so that the instrument automatically configure and perform tests on every aspect of all the carriers.

Setting Mode

| Step | Description |
|--|--|
| 1. Connect the cable | Connect a cable directly or indirectly as shown in the section Connecting a Cable on page 7 of this chapter. |
| 2. Select the mode MODE [Signal Analyzer] [More (1/2)] [TD-SCDMA] [Auto Measure] | Press the MODE hard key. Press the Signal Analyzer soft key. Press the More (1/2) soft key to get more soft keys. Press the TD-SCDMA soft key. Press the Auto Measure soft key. |

Following settings are required only when you run Auto Measure on the instrument using “Current” configuration setting. Additional settings are not required when you run Auto Measure using a scenario generated in the PC application software, JDViewer.

Setting Frequency

| Step | Description |
|---|---|
| 1. Set the frequency FREQ/DIST [Unit] <Freq> or <Channel> <i>When Freq is selected:</i> [Center Frequency] Enter a value [GHz], [MHz], [kHz], or [Hz] <i>When Channel is selected:</i> | Press the FREQ/DIST hard key. Press the Unit soft key. Toggle this key between Freq and Channel . A set of Freq/Dist screen menu changes accordingly. Press the Center Frequency soft key. Use the numeric keys, the rotary knob, or the arrow keys. When using the numeric keys, the input is completed by selecting one of the unit soft keys. |

| | |
|---|--|
| <p>[Channel Standard] Select a channel standard</p> | <p>Press the Channel Standard soft key. Press the arrow keys, rotate the knob, or press the Page Up and Page Down soft keys to highlight a frequency band to select.</p> |
| <p>[Select] or ENTER</p> | <p>Press the Select soft key or the ENTER hard key.</p> |
| <p>[Channel Number] Enter a value [Forward]</p> | <p>Press the Channel Number soft key. Use the numeric keys to input value and press the Forward soft key to complete the input. The instrument automatically displays its corresponding center frequency value for the channel number.</p> |

FREQ/DIST



- n **UNIT:** Determines the way how to set the frequency band either with standard band or custom frequency band. Toggling this key between **Freq** and **Channel** changes a set of Freq/Dist screen menu automatically.
- n **CENTER FREQUENCY:** Changes the center frequency setting. Use the rotary knob or the arrow keys. Or use the numeric keys to input a certain value and press one of the unit soft keys to complete the input.
- n **FREQUENCY STEP:** Defines the amount of frequency to be increased or decreased when using the rotary knob or the arrow keys to change the **Center Frequency**. This frequency step size can be entered by using numeric keys and the unit soft keys.
- n **CHANNEL NUMBER:** Enters a channel number. The instrument automatically displays its corresponding center frequency value for the channel number.
- n **CHANNEL STEP:** Defines the amount of channel to be increased or decreased when using the rotary knob or the arrow keys to change the **Channel Number**. This channel step size can be entered by using numeric keys and the **Enter** soft key.
- n **CHANNEL STANDARD:** When the channel standard is selected from the list, the center frequency information on the display screen will be mapped accordingly to the selected channel standard. The channel standards available in the instrument are listed in the Appendix C – Band, Frequency & Channel Standard.

Setting Limit

LIMIT



This hot key is used to set the threshold value for the limit line on the display screen. It turns on or off

the limit or band limit settings of the measurement for pass/fail indication. The user input window must be inactive first to get the Limit hot key function other than the number input.

| Step | Description |
|--|--|
| <p>1. Set the RF test limit</p> <p>LIMIT</p> <p>[RF Test Limits]</p> <p>[Channel Power]</p> <p>[Test Limits] <On> or <Off></p> <p>[High Limit] Enter a value [dBm] or ENTER</p> <p>[Low Limit] Enter a value [dBm] or ENTER</p> <p>[Occupied BW]</p> <p>[Test Limit] <On> or <Off></p> <p>[High Limit] Enter a value [MHz], [kHz], or [Hz]</p> <p>[Spectrum Emission Mask]</p> <p>[Test Limit] <On> or <Off></p> <p>[ACLR]</p> <p>[Test Limit] <On> or <Off></p> <p>[Multi-ACLR]</p> <p>[Test Limit] <On> or <Off></p> <p>[Spurious Emissions]</p> <p>[Test Limit] <On> or <Off></p> | <p>Press the LIMIT hot key.</p> <p>Press the RF Test Limits soft key.</p> <p>Press the Channel Power soft key.</p> <p>Press the Test Limits soft key to toggle between On and Off and select one.</p> <p>Press the High Limit soft key to set the upper limit of the Pass/Fail criteria. Use the numeric keys to input value.</p> <p>Press the unit soft key or the ENTER hard key.</p> <p>Press the Low Limit soft key to set the lower limit of the Pass/Fail criteria. Use the numeric keys to input value.</p> <p>Press the unit soft key or the ENTER hard key.</p> <p>Press the Occupied BW soft key.</p> <p>Press the Test Limit soft key to toggle between On and Off and select one.</p> <p>Press the High Limit soft key to set the upper limit of the Pass/Fail criteria. Use the numeric keys to input value.</p> <p>Press the unit soft key to select.</p> <p>Press the Spectrum Emission Mask soft key.</p> <p>Press the Test Limit soft key to toggle between On and Off and select one.</p> <p>Press the ACLR soft key.</p> <p>Press the Test Limit soft key to toggle between On and Off and select one.</p> <p>Press the Multi-ALPR soft key.</p> <p>Press the Test Limit soft key to toggle between On and Off and select one.</p> <p>Press the Spurious Emissions soft key.</p> <p>Press the Test Limit soft key to toggle between On and Off and select one.</p> |
| <p>2. Enable beep</p> <p>LIMIT</p> <p>[Beep] <On> or <Off></p> | <p>Press the LIMIT hot key.</p> <p>Press the Beep soft key to toggle between On and Off and select one. This will make audible alarm if the</p> |

| | |
|--|---|
| | measurement result goes beyond the limit. |
|--|---|

- n **CHANNEL POWER:** Sets the test limit parameters.
 - Y **TEST LIMITS:** Enables or disables Pass/Fail results on the display screen. Toggle the **Test Limits** soft key to set it to **On** or **Off**.
 - Y **HIGH LIMIT:** Sets the upper limit of the Pass/Fail criteria. Use the numeric keys to enter a threshold or limit value and press the **dBm** unit soft key or the **ENTER** hard key to complete the input.
 - Y **LOW LIMIT:** Sets the lower limit of the Pass/Fail criteria. Use the numeric keys to enter a threshold or limit value and press the **dBm** unit soft key or the **ENTER** hard key to complete the input.
- n **OCCUPIED BW:** Sets the test limit parameters.
 - Y **TEST LIMIT:** Enables or disables Pass/Fail results on the display screen. Toggle the **Test Limit** soft key to set it to **On** or **Off**.
 - Y **HIGH LIMIT:** Sets the upper limit of the Pass/Fail criteria. Use the numeric keys to enter a threshold or limit value and press one of the unit soft keys to complete the input.
- n **SPECTRUM EMISSION MASK:** Sets the test limit parameter.
 - Y **TEST LIMIT:** Enables or disables Pass/Fail results on the display screen. Toggle the **Test Limit** soft key to set it to **On** or **Off**.
- n **ACLR:** Sets the test limit parameter.
 - Y **TEST LIMIT:** Enables or disables Pass/Fail results on the display screen. Toggle the **Test Limit** soft key to set it to **On** or **Off**.
- n **MULTI-ACLR:** Sets the test limit parameter.
 - Y **TEST LIMIT:** Enables or disables Pass/Fail results on the display screen. Toggle the **Test Limit** soft key to set it to **On** or **Off**.
- n **SPURIOUS EMISSIONS:** Sets the test limit parameter.
 - Y **TEST LIMIT:** Enables or disables Pass/Fail results on the display screen. Toggle the **Test Limit** soft key to set it to **On** or **Off**.

Measurement Procedure

| Step | Description |
|--------------------|-------------|
| 1. Select the mode | |

| | |
|---|--|
| <p>MEASURE [Auto Measure]</p> | <p>Press the MEASURE hot key. Press the Auto Measure soft key.</p> |
| <p>2. Set the measurement parameters</p> <p>MEASURE SETUP</p> <p>[Configuration] <Current> or <Scenario></p> <p>[Load Scenario]</p> <p>[Test Time] <Now> or <Schedule></p> <p>[Set Timing]</p> <p>[Start Time (HH:MM)] Enter a value [HHMM]</p> <p>[Stop Time (HH:MM)] Enter a value [HHMM]</p> <p>[Time Interval] Enter a value [Min]</p> <p>[Save Result] [File Name]</p> <p>[Save to] <Internal> or <USB></p> <p>[Save Screen] <All> or <Fail></p> <p>[Settings]</p> <p>[Slot Number] [TS0], [TS1], [TS2], [TS3], [TS4], [TS5], or [TS6]</p> <p>[Scramble] <Auto> or <Manual></p> <p>[Run Test]</p> | <p>Press the MEASURE SETUP hot key. Press the Configuration soft key to select the mode. Toggle this soft key between Current and Scenario.</p> <p>Press the Load Scenario soft key to load a scenario file. This key is active only when the Configuration is set to Scenario.</p> <p>Press the Test Time soft key to select when to run a test. Toggle this soft key between Now and Schedule.</p> <p>Press the Set Timing soft key. This key is activated only when the Test Time is set to Schedule. Press the Start Time soft key. Use the numeric keys to input value in HH:MM format. Press the HHMM soft key to complete the input. Press the Stop Time soft key. Use the numeric keys to input value in HH:MM format. Press the HHMM soft key to complete the input. Press the Time Interval soft key. Use the numeric keys to input value in minutes. Press the Min soft key to complete the input.</p> <p>Press the Save Result soft key. Press the File Name soft key to assign a specific name to the test result. Press the Save to soft key to select where to save the test result. Toggle this soft key between Internal and USB. Press the Save Screen soft key to choose its save option. Toggle this soft key between All and Fail. This key is activated only when the Save to is set to USB.</p> <p>Press the Settings soft key. Press the Slot Number soft key. Press one of the soft keys to select the time slot number.</p> <p>Press the Scramble soft key. The Auto mode is set by default. Toggle between Auto and Manual.</p> <p>Press the Run Test soft key to run a test.</p> |

TD-SCDMA Auto Measurement Procedure

MEASURE SETUP



- n **RUN TEST:** Starts a test.
- n **CONFIGURATION:** Selects the measurement configuration to be used. When the **Current** is selected, the instrument runs a test using current carrier frequency (single carrier) and determines pass/fail based on the instrument's limit settings. Select the **Scenario** to run a test with a programmed scenario.
- n **LOAD SCENARIO:** Selects and loads a scenario file generated by the PC application software, JDViewer. This soft key is activated only when the **Configuration** is set to **Scenario**.
- n **TEST TIME:** Selects the test time. When **Now** is selected, the instrument runs a test only once. When **Schedule** is selected, the instrument repeats tests as defined in the **Set Timing** menu.
- n **SET TIMING:** Sets the **Start Time**, **Stop Time**, and **Time Interval** of a scheduled measurement. This soft key is activated only when the **Test Time** is set to **Schedule**.
- n **SAVE RESULT:** Sets parameters for saving measurement results. The instrument automatically saves measurement results in *.CSV format as well so that they can be imported in an application software that supports the CSV format.
 - Y **FILE NAME:** Sets the measurement result file name.
 - Y **SAVE TO:** Sets the destination where the result to be saved, **Internal** or **USB**.
 - Y **SAVE SCREEN:** Selects what results to be saved into a USB drive. Toggle this soft key between **All** for all the measurement items and **Fail** for failed items only. This key is activated only when the **Save to** is set to **USB**.
- n **SETTINGS:** Sets the scramble code and the time slot number.
 - Y **SCRAMBLE:** Sets the scramble code to **Auto** or **Manual**. Toggle between **Auto** and **Manual**. To change the value in the **Manual** mode, use the numeric keys to enter a value between 0 and 511 and press the **Enter** soft key or the **ENTER** hard key to complete to the input.
 - Y **SLOT NUMBER:** Sets the time slot number to be displayed on the measurement screen. Select the slot number among **TS0**, **TS1**, **TS2**, **TS3**, **TS4**, **TS5** and **TS6**.
 - Y **EXTERNAL OFFSET:** Sets an external offset value. An offset consists of a cable loss and a user offset and the measurement result shows the value reflecting both offset values. When the external offset value is set at 40 dB in the Spectrum mode, the measurement result compensates 40 dB at both the Spectrum Analyzer and Signal Analyzer modes.

Setting Display

TRACE/DISPLAY 

- n **DISPLAY:** Changes the display option. After running automatic measurement, toggle this key between **Results** and **Settings**.
 - Y **RESULTS:** Shows actual measurement results on the display screen.
 - Y **SETTINGS:** Shows measurement parameters set for the automatic measurement.
- n **DISPLAY RESULTS:** Changes the display format of measurement results. This key becomes activated when the **Results** is set as the display option. Toggle this key between **Full** and **Quick** to check measurement results in different format.
 - Y **FULL:** Shows detailed measurement results, including actual measurement readings with pass/fail color indication.
 - Y **QUICK:** Shows quick view of pass/fail results.
- n **VIEW CARRIER:** Selects a carrier to be displayed among up to 10 carriers. This key becomes activated when the **Results** is set as the display option.

TD-SCDMA OTA MEASUREMENTS

TD-SCDMA OTA Measurements provide the following essential measurements.

- n Sync-DL ID Scanner
- n Sync-DL ID vs Tau
- n Sync-DL ID Multipath
- n Sync-DL ID Analyzer
- n Route Map

Setting Mode

Connecting a GPS antenna with the instrument is a mandatory for the OTA measurements.

| Step | Description |
|------------------------|--|
| 1. Connect the antenna | Connect antennas as shown in the Connecting a Cable on page 8 of this chapter. |

| | |
|---|--|
| <p>2. Select the mode</p> <p>MODE</p> <p>[Signal Analyzer]</p> <p>[More (1/2)]</p> <p>[TD-SCDMA]</p> <p>[OTA]</p> <p>[Sync-DL ID Scanner],</p> <p>[Sync-DL ID vs Tau],</p> <p>[Sync-DL ID Multipath],</p> <p>[Sync-DL ID Analyzer], or</p> <p>[Mapping]</p> | <p>Press the MODE hard key.</p> <p>Press the Signal Analyzer soft key.</p> <p>Press the More (1/2) soft key to get more soft keys.</p> <p>Press the TD-SCDMA soft key.</p> <p>Press the OTA soft key.</p> <p>Press one of the measurement mode soft keys to select.</p> |
|---|--|

Setting Frequency

| Step | Description |
|--|--|
| <p>1. Set the frequency</p> <p>FREQ/DIST</p> <p>[Unit]</p> <p><Freq> or <Channel></p> <p><i>When Freq is selected:</i></p> <p>[Center Frequency]</p> <p>Enter a value</p> <p>[GHz], [MHz], [kHz], or [Hz]</p> <p><i>When Channel is selected:</i></p> <p>[Channel Standard]</p> <p>Select a channel standard</p> <p>[Select] or ENTER</p> <p>[Channel Number]</p> <p>Enter a value</p> <p>[Forward]</p> | <p>Press the FREQ/DIST hard key.</p> <p>Press the Unit soft key. Toggle this key between Freq and Channel. A set of Freq/Dist screen menu changes accordingly.</p> <p>Press the Center Frequency soft key.</p> <p>Use the numeric keys, the rotary knob, or the arrow keys.</p> <p>When using the numeric keys, the input is completed by selecting one of the unit soft keys.</p> <p>Press the Channel Standard soft key.</p> <p>Press the arrow keys, rotate the knob, or press the Page Up and Page Down soft keys to highlight a frequency band to select.</p> <p>Press the Select soft key or the ENTER hard key.</p> <p>Press the Channel Number soft key.</p> <p>Use the numeric keys to input value and press the Forward soft key to complete the input. The instrument automatically displays its corresponding center frequency value for the channel number.</p> |

FREQ/DIST



- n **UNIT:** Determines the way how to set the frequency band either with standard band or custom frequency band. Toggling this key between **Freq** and **Channel** changes a set of Freq/Dist screen menu automatically.
- n **CENTER FREQUENCY:** Changes the center frequency setting. Use the rotary knob or the arrow keys. Or use the numeric keys to input a certain value and press one of the unit soft keys to complete the input.
- n **FREQUENCY STEP:** Defines the amount of frequency to be increased or decreased when using the rotary knob or the arrow keys to change the **Center Frequency**. This frequency step size can be entered by using numeric keys and the unit soft keys.
- n **CHANNEL NUMBER:** Enters a channel number. The instrument automatically displays its corresponding center frequency value for the channel number.
- n **CHANNEL STEP:** Defines the amount of channel to be increased or decreased when using the rotary knob or the arrow keys to change the **Channel Number**. This channel step size can be entered by using numeric keys and the **Enter** soft key.
- n **CHANNEL STANDARD:** When the channel standard is selected from the list, the center frequency information on the display screen will be mapped accordingly to the selected channel standard. The channel standards available in the instrument are listed in the Appendix C – Band, Frequency & Channel Standard.

Setting Amplitude

| Step | Description |
|---|---|
| <p>1. Set the reference/attenuation level</p> <p>AMP/SCALE</p> <p>[Auto Scale]</p> <p>or</p> <p>[Reference Level]</p> <p>Enter a reference level value</p> <p>[dBm] or ENTER</p> <p>[Attenuation]</p> <p><Manual></p> <p>Enter an attenuation value</p> | <p>Press the AMP/SCALE hard key.</p> <p>Press the Auto Scale soft key to automatically set optimum levels of reference and attenuation.</p> <p>Press the Reference Level soft key to set manually.</p> <p>Use the numeric keys or the rotary knob that changes in a 10 dB step.</p> <p>Press the dBm soft key or the ENTER hard key.</p> <p>Press the Attenuation soft key. The Auto mode is set by default. This key toggles between the Auto and Manual.</p> <p>Press the Attenuation soft key to highlight the Manual mode and change the attenuation value to optimize S/N.</p> <p>Use the numeric keys or the rotary knob that changes in a 5 dB step. The attenuation setting range is 0 to 50 dB.</p> |

AMP/SCALE



- n **AUTO SCALE:** The instrument can automatically set the scale to the minimum and maximum values on the Y-axis of the graph for optimum display of the traces measured. Each time the **Auto Scale** is selected, the top and bottom scales are set to the minimum and maximum values with margin on the Y-axis of the display screen.
- n **REFERENCE LEVEL:** Sets the maximum Y-axis range. *This key is used in the Route Map mode.*
- n **ATTENUATION**
 - Y **AUTO:** Input attenuator's value is automatically set depending on the reference level. This is the default operation mode, so it is recommended to use this mode unless a special measurement condition is needed.
 - Y **MANUAL:** Sets the attenuator's value for the **Spectrum Analyzer RF In 50 Ω** port.
- n **PREAMP:** Turns on or off the internal pre-amplifier. Preamp results in a correction being applied to compensate for the gain of the preamp so that amplitude readings show the value at the input connector. This soft key toggles between the **On** and **Off**. When it is set to On, the allowable attenuation input range is from 0 dB to 10 dB in a multiple of 5. If the attenuation value is manually set greater than 10 dB, the instrument will automatically turn off the pre-amplifier to display low level signal properly on the screen.
- n **EXTERNAL OFFSET:** Sets an external offset value. An offset consists of a cable loss and a user offset and the measurement result shows the value reflecting both offset values. When the external offset value is set at 40 dB in the Spectrum mode, the measurement result compensates 40 dB at both the Spectrum Analyzer and Signal Analyzer modes.

Setting Sweep Mode

SWEEP



This hot key is used to set the sweep parameters. The user input window must be inactive first to get the Sweep hot key function other than the number input.

- n **SWEEP MODE:** Sets the sweep method. Toggle between **Continue** and **Single**.

| Step | Description |
|--|---|
| 1. Set the sweep mode SWEEP [Sweep Mode] | Press the SWEEP hot key. Press the Sweep Mode soft key. Toggle between Continue and Single . |

Setting Trigger Source

TRIGGER

This hot key is used to select the trigger source among **Internal**, **External**, and **GPS**. The user input window must be inactive first to get the Trigger hot key function other than the number input. For OTA measurement, a GPS antenna should be connected and the trigger source should be set to **GPS**.

Setting External Clock

To enhance the reliability of modulation analysis measurements the JD740A series must be synchronized with the Base Station. When an external clock is not supplied, the JD740A series works with a built-in internal high-accuracy time base. In this case, some measurement results may exhibit inaccurate values. Therefore, it is highly recommended to use the same reference clock as signal source. Trigger mode can be changed by using the **TRIGGER** hot key.

EXTERNAL CLOCK OPERATING STANDARDS

| Clock | Type | Reference | Port | Switching Standard |
|--------------------|----------|--------------------|---------------|--|
| External Reference | Internal | Internal 10 MHz | | Default |
| | External | External Ref Clock | Ext Ref (SMA) | Manual switching (Input signal level >-3 dBm) |
| | GPS | GPS Clock | GPS (SMA) | Automatic switching (GPS signal received) |
| Trigger | Internal | Internal Trigger | | Default |
| | External | External Trigger | Trigger (SMA) | Manual switching |
| | GPS | GPS | GPS (SMA) | Manual switching |

CONNECTION

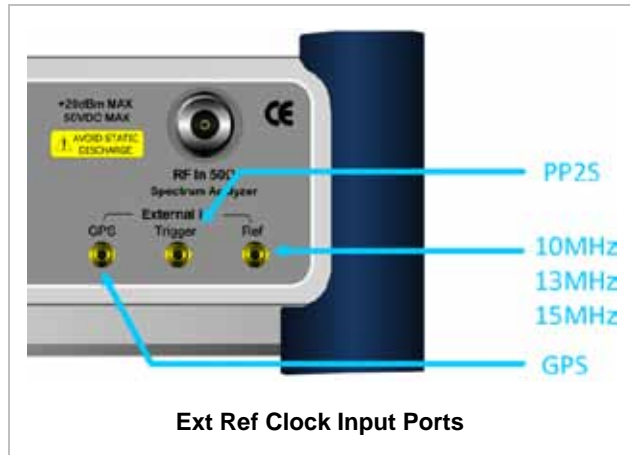

ENABLING GPS EXTERNAL REFERENCE

| Step | Description |
|--|--|
| 1. Connect a GPS antenna | Connect a GPS antenna to the JD740A series. |
| 2. Change reference clock SYSTEM [Frequency Reference] [GPS] | Press the SYSTEM hot key. Press the Frequency Reference soft key. Press the GPS soft key to perform OTA measurements. |

GPS EXTERNAL REFERENCE INDICATOR INFORMATION

When a GPS antenna is connected, the instrument automatically detects it. Each indicator tells different locking status depending on its connection. If it is successfully locked, the instrument will display "GPS" and longitude and latitude information on the screen. If it is unlocked or the antenna is disconnected, the display will be automatically switched to "Internal".

| Type | Indicator | Description |
|------|-----------|----------------------------------|
| GPS | (Green) | Locked |
| | (Yellow) | Locking in progress |
| | (Gray) | Unable to lock or antenna failed |

TD-SCDMA OTA SYNC-DL ID SCANNER

Measurement Procedure

| Step | Description |
|---|---|
| 1. Set the measurement mode MEASURE [OTA] [Sync-DL ID Scanner] | Press the MEASURE hot key. Press the OTA soft key. Press the Sync-DL ID Scanner soft key. |
| 2. Set the measurement parameters MEASURE SETUP [Sync-DL ID] <Auto> or <Manual> | Press the MEASURE SETUP hot key. Press the Sync-DL ID soft key. Toggle between Auto and Manual . |

TD-SCDMA OTA Sync-DL ID Scanner Measurement Procedure

MEASURE SETUP



- n **SYNC-DL ID:** Sets the Sync-DL ID to **Auto** or **Manual**. Toggle between **Auto** and **Manual**.
- n **MISCELLANEOUS**
- Y **DELAY:** Sets the delay in micro seconds. This key is used only when there is a time offset in the signals to be measured.

Measurement Example

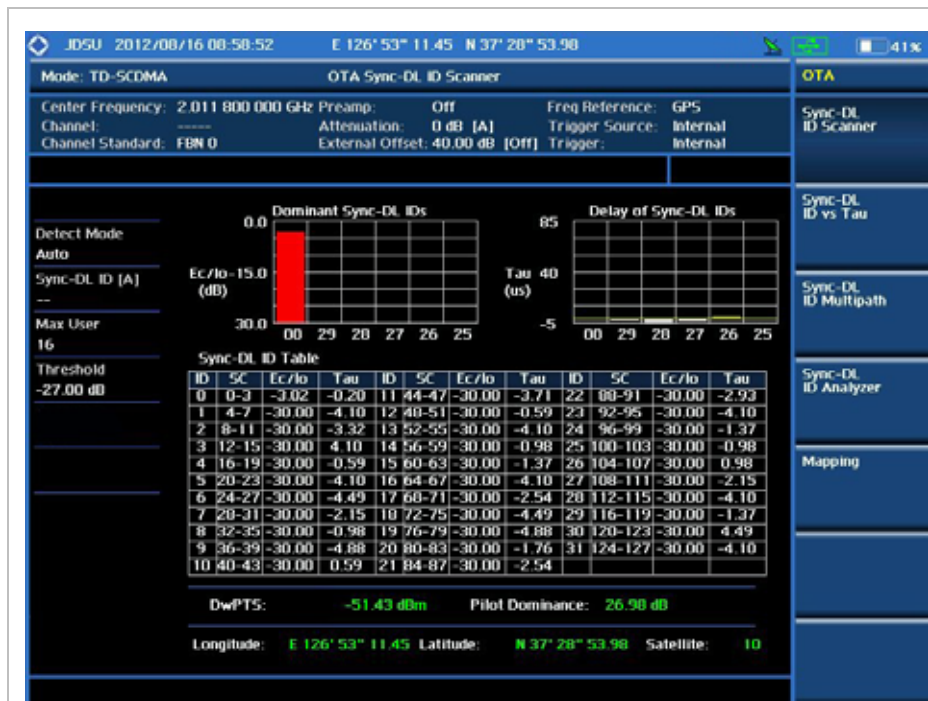

TD-SCDMA OTA Sync-DL ID Scanner Measurement Screen

TD-SCDMA OTA SYNC-DL ID vs TAU

Measurement Procedure

| Step | Description |
|---|---|
| 1. Set the measurement mode MEASURE [OTA] [Sync-DL ID vs Tau] | Press the MEASURE hot key. Press the OTA soft key. Press the Sync-DL ID vs Tau soft key. |
| 2. Set the measurement parameters MEASURE SETUP [Sync-DL ID] <Auto> or <Manual> [Auto Save] <On> or <Off> | Press the MEASURE SETUP hot key. Press the Sync-DL ID soft key. Toggle between Auto and Manual . Press the Auto Save soft key. Toggle between On and Off . |

TD-SCDMA OTA Sync-DL ID vs Tau Measurement Procedure

MEASURE SETUP



- n **SYNC-DL ID:** Sets the Sync-DL ID to **Auto** or **Manual**. Toggle between **Auto** and **Manual**.
- n **AUTO SAVE:** Enables or disables automatic saving of the measurement data to an external USB memory. When it turns on, the measurements will be recorded into the default file (logging.ota) or a user-named file.
- n **MISCELLANEOUS**
 - Y **DELAY:** Sets the delay in micro seconds. This key is used only when there is a time offset in the signals to be measured.

Setting Display

TRACE/DISPLAY



- n **Tau LENGTH:** Sets the Tau length. Default setting is 85. Every time this soft key is pressed, the selection moves among **40**, **85**, and **120** in micro-second.

Measurement Example

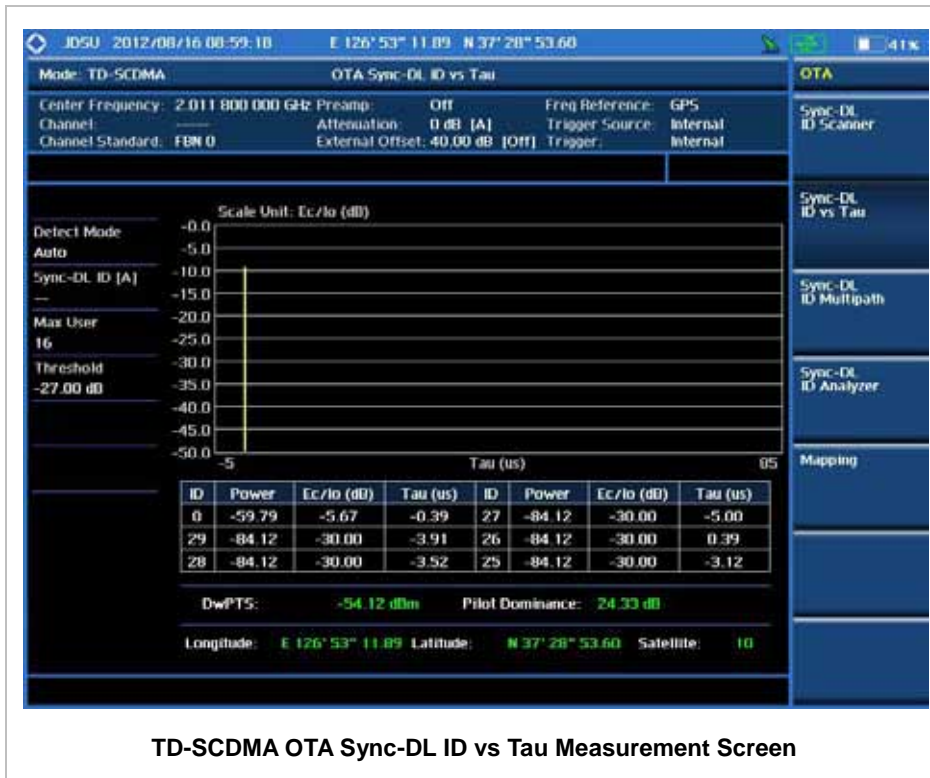

TD-SCDMA OTA Sync-DL ID vs Tau Measurement Screen

TD-SCDMA OTA SYNC-DL ID MULTIPATH

Measurement Procedure

| Step | Description |
|---|---|
| 1. Set the measurement mode MEASURE [OTA] [Sync-DL ID Multipath] | Press the MEASURE hot key. Press the OTA soft key. Press the Sync-DL ID Multipath soft key. |
| 2. Set the measurement parameters MEASURE SETUP [Sync-DL ID] <Auto> or <Manual> | Press the MEASURE SETUP hot key. Press the Sync-DL ID soft key. Toggle between Auto and Manual . |

TD-SCDMA OTA Sync-DL ID Multipath Measurement Procedure

MEASURE SETUP



- n **SYNC-DL ID:** Sets the Sync-DL ID to **Auto** or **Manual**. Toggle between **Auto** and **Manual**.
- n **MISCELLANEOUS**
 - Y **DELAY:** Sets the delay in micro seconds. This key is used only when there is a time offset in the signals to be measured.

Setting Display



TRACE/DISPLAY

- n **Tau LENGTH:** Sets the Tau length. Default setting is 85. Every time this soft key is pressed, the selection moves among **40**, **85**, and **120** in micro-second.

Measurement Example

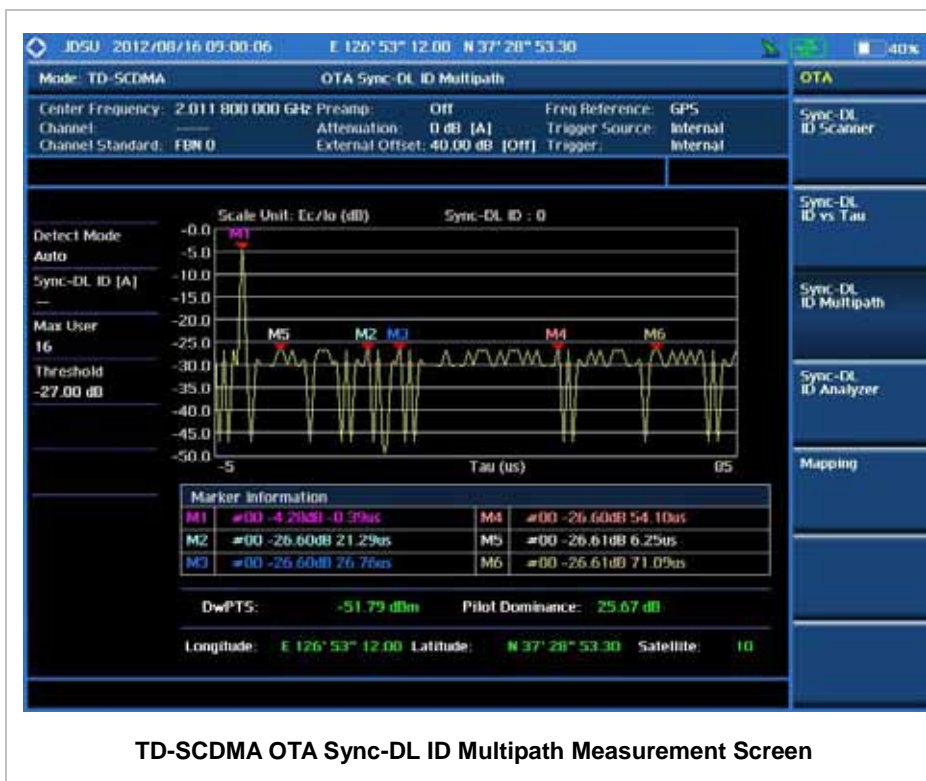

TD-SCDMA OTA SYNC-DL ID ANALYZER

Measurement Procedure

| Step | Description |
|---|---|
| 1. Set the measurement mode MEASURE [OTA] [Sync-DL ID Analyzer] | Press the MEASURE hot key. Press the OTA soft key. Press the Sync-DL ID Analyzer soft key. |
| 2. Set the measurement parameters MEASURE SETUP [Sync-DL ID] <Auto> or <Manual> [Auto Save] <On> or <Off> | Press the MEASURE SETUP hot key. Press the Sync-DL ID soft key. Toggle between Auto and Manual . Press the Auto Save soft key. Toggle between On and Off . |

TD-SCDMA OTA Sync-DL ID Analyzer Measurement Procedure

MEASURE SETUP



- n **SYNC-DL ID:** Sets the Sync-DL ID to **Auto** or **Manual**. Toggle between **Auto** and **Manual**.
- n **AUTO SAVE:** Enables or disables automatic saving of the measurement data to an external USB memory. When it turns on, the measurements will be recorded into the default file (logging.ota) or a user-named file.
- n **MISCELLANEOUS**
 - Y **DELAY:** Sets the delay in micro seconds. This key is used only when there is a time offset in the signals to be measured.

Measurement Example

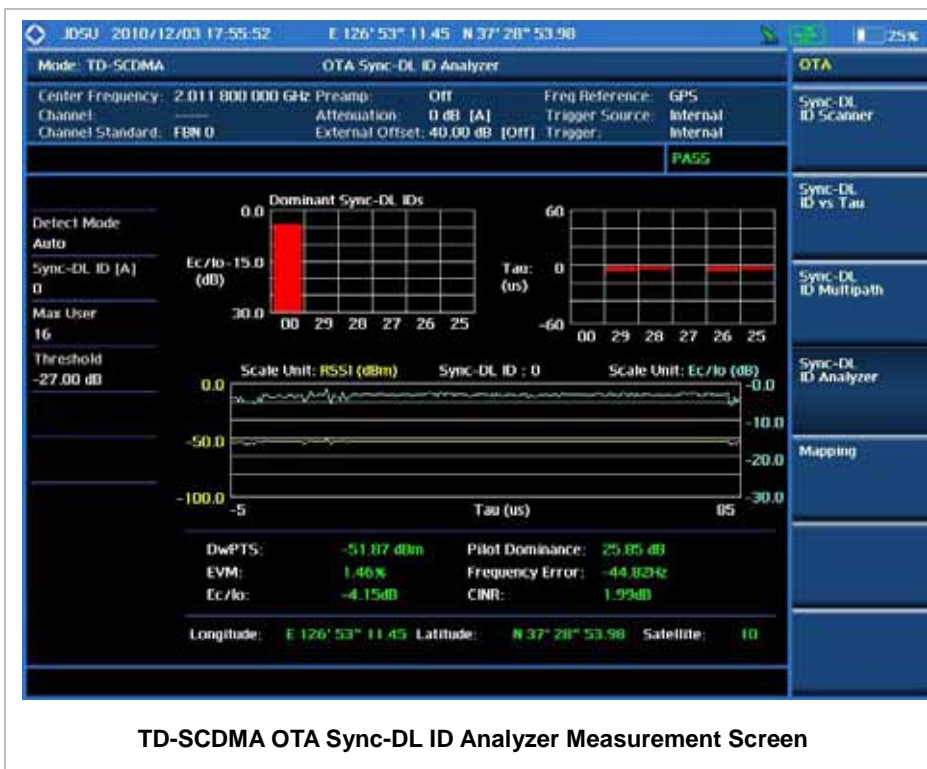

TD-SCDMA OTA Sync-DL ID Analyzer Measurement Screen

TD-SCDMA ROUTE MAP

The JD740A Series provides indoor and outdoor mapping function that allows a user to collect data of points in an indoor or outdoor environment and track the received signals and coverage of RF transmitters plotting real time directly on top of a loaded floor plan or a map.

Measurement Procedure

| Step | Description |
|---|--|
| 1. Set the measurement mode MEASURE [OTA] [Route Map] | Press the MEASURE hot key. Press the OTA soft key. Press the Route Map soft key. |
| 2. Set the measurement parameters MEASURE SETUP [Load Map] | Press the MEASURE SETUP hot key. After plugging in a USB drive, press the Load Map soft key to load a map file created in JDMAPCreator and copied into the USB drive. |

| | |
|---|--|
| <p>[Plot Point] [Position] or [GPS]</p> | <p>Press the Plot Point soft key to get option menu. Press the Position soft key without a GPS antenna or the GPS with one. Selecting GPS activates the Screen Mode soft key to be set.</p> |
| <p>[Screen Mode] <Map> or <Full></p> | <p>Press the Screen Mode soft key. Toggle this key between Map and Full.</p> |
| <p>[Plot] <Start> or <Stop></p> | <p>Press the Plot soft key to start or stop plotting. Toggle this key between Start and Stop.</p> |

MEASURE SETUP



Sets the measurement parameters for the Route Map. The legend displayed in different colors at the bottom of the screen can be set with the **Limit** hot key.

- n **PLOT:** Starts or stops a measurement in order to plot received signals or collected data on top of a loaded map. Toggle this key between **Start** and **Stop**. The instrument does not automatically save collected data. After stopping the current route mapping, the user needs to save the result with the **Save** hot key for later use. If not, all the collected data for the route will be lost.
- n **PLOT POINT:** Selects a method of plotting points. The instrument collects the strongest DwPTS data and plots them.
 - Y **POSITION:** Measures data without GPS in an indoor environment. After starting to plot, press the **Enter** hard key or the center of the rotary knob as you move with the instrument. Each time the user presses the key or the knob, the instrument plots a point on top of the loaded map. Use the arrow keys to change direction of route and the rotary knob to change distance. If the instrument has the screen with touch screen, directly touch the screen in order to collect data.
 - Y **GPS:** Automatically collects data with GPS in an outdoor environment and plots points as the user moves in a vehicle.
- n **SCREEN MODE:** Selects either **Map** or **Full**, depending on how to show collected points on the screen. Selecting GPS for the Plot Point activates this key. Numbers shown next to the points represent their DwPTS IDs. The instrument displays DwPTS ID of the start point and those of the points with different DwPTS IDs from the right previous ones.
 - Y **MAP:** Displays collected points only that can be seen within the boundary of the loaded map. If a point is off the map, the instrument displays an arrow indicating the direction of the current location on the map and the distance from the center to the location at the top of the screen.
 - Y **FULL:** Displays all the points measured for route on the screen without the map.

- n **LOAD MAP:** Loads a floor plan or a map file created in **JDMapCreator**. The JDMapCreator converts and resizes any scanned floor plan or layout so that it can be loaded and fit to the instrument display.

Setting Limit



This hot key is used to set threshold values for the legend displayed on the screen. The different colors of the legend indicate the quality of the measured data depending on their threshold setting. The user input window must be inactive first to get the Limit hot key function other than the number input.

| Step | Description |
|---|--|
| <p>1. Set the limit</p> <p>Limit</p> <p>[Excellent] Enter a value [Enter]</p> <p>[Very Good] Enter a value [Enter]</p> <p>[Good] Enter a value [Enter]</p> <p>[Fair] Enter a value [Enter]</p> <p>[Poor] Enter a value [Enter]</p> | <p>Press the LIMIT hot key to set the threshold.</p> <p>Press the Excellent soft key.</p> <p>Use the rotary knob or the numeric keys.</p> <p>Press the Enter soft key.</p> <p>Press the Very Good soft key.</p> <p>Use the rotary knob or the numeric keys.</p> <p>Press the Enter soft key.</p> <p>Press the Good soft key.</p> <p>Use the rotary knob or the numeric keys.</p> <p>Press the Enter soft key.</p> <p>Press the Fair soft key.</p> <p>Use the rotary knob or the numeric keys.</p> <p>Press the Enter soft key.</p> <p>Press the Poor soft key.</p> <p>Use the rotary knob or the numeric keys.</p> <p>Press the Enter soft key.</p> |

Measurement Example



Route Map Measurement Screen (Map View)



Route Map Measurement Screen (Full View)

ANALYSIS

Using Marker



Marker is used to get the information about a specific trace. Six markers can be set on the display and each marker can be used independently. The X and Y coordinates of the trace are displayed when the marker is placed on any position of the trace. The position displaying the marker's X and Y coordinates may be slightly different for each measurement mode and refer to the description of each measurement. There are three different marker types available: Normal, Delta, and Delta pair. Marker position can be set manually by entering numeric values (frequency) when one of the marker types is selected.

- n **SELECT MARKER:** Selects an active marker whose position can be changed with the rotary knob or the arrow keys. The assigned number of the active marker is displayed in the **Select Marker** menu box and the active marker number is also displayed right next to the active marker on the trace when the **Marker View** is set to **On**.
- n **MARKER VIEW:** Displays the selected marker on the screen or hides it. When the **Marker View** is turned off and then on again in the same measurement mode, markers appear at the previous positions. If a measurement mode is changed, markers are not restored to their previous positions.
- n **NORMAL:** This Normal marker type provides the reading of a marker position on the trace along with the marker number between 1 and 6.
- n **DELTA:** This Delta marker type is associated with a Normal marker. A Normal marker must be set before a Delta marker is set. When the Delta marker is set, the position set by the Delta marker becomes the reference position of the Normal marker and the marker's X and Y values displays the difference compared with the Delta marker.
- n **DELTA PAIR:** This Delta Pair marker type is associated with a Normal marker. A Normal marker must be set before a Delta Pair marker is set. When the Delta Pair marker is set, the position set by the Delta Pair marker becomes the reference position of the Normal marker and the marker's X and Y values displays the difference compared with the Delta Pair marker. The reference position will be varied in accordance with trace change.
- n **MARKER ALL OFF:** Turns all the markers the screen off. When the Marker View is selected for those markers, the instrument displays those markers back at the previous position. If a measurement mode is changed, current settings are not restored.
- n **MARKER \rightarrow :** Sets the X coordinate of the active marker as selected.
 - Y **MARKER \rightarrow CENTER:** Sets the frequency of the active marker to the center frequency of spectrum analyzer.
 - Y **MARKER \rightarrow START:** Sets the frequency of the active marker to the start frequency of spectrum analyzer.

- **MARKERà STOP:** Sets the frequency of the active marker to the stop frequency of spectrum analyzer.

Using Peak Search

PEAK SEARCH



Each time the Peak Search soft key is pressed, the active marker is positioned at the highest peak of the trace.

- n **PEAK SEARCH:** Moves the active marker to the highest peak of the trace.
- n **NEXT PEAK:** Moves the active marker to the second highest peak of the trace.
- n **NEXT PEAK RIGHT:** Moves the active marker to the highest peak to the right of its current position.
- n **NEXT PEAK LEFT:** Moves the active marker to the highest peak to the left of its current position.
- n **MIN SEARCH:** Moves the active marker to the lowest peak of the trace.
- n **ALWAYS PEAK:** When the **Always Peak** is set to On, the instrument moves the active marker automatically to the highest peak of the trace every time the trace is refreshed.

Mobile WiMAX Signal Analyzer

This Mobile WiMAX Signal Analyzer function is optional that the JD740AA series offers as the Option 026. It allows the user to analyze Mobile WiMAX system performance. The user may alter the measurement parameters for specialized analysis. The Mobile WiMAX OTA Analyzer which is the Option 046 can be added to the Mobile WiMAX Signal Analyzer for Over The Air measurement.

In this Chapter

| | |
|--|----|
| Using Mobile WiMAX Signal Analyzer | 4 |
| Display Overview | 5 |
| Connecting a Cable | 6 |
| Direct Connection..... | 6 |
| Indirect Connection | 7 |
| Over The Air (OTA) | 7 |
| Spectrum Analysis Measurement..... | 9 |
| Setting Mode | 9 |
| Setting Frequency | 9 |
| Setting Amplitude | 10 |
| Setting Averaging | 12 |
| Setting Sweep Mode | 12 |
| Setting Trigger Source | 12 |
| Setting External Clock..... | 13 |
| Setting Trace and Display | 14 |
| Measurement Procedure | 15 |
| Measurement Example | 16 |
| RF Analysis Measurements..... | 17 |
| Setting Mode | 17 |
| Setting Frequency | 17 |
| Setting Amplitude | 19 |
| Setting Averaging | 20 |
| Setting Sweep Mode | 20 |
| Setting Trigger Source | 21 |
| Setting External Clock..... | 21 |
| Channel Power | 23 |
| Measurement Procedure | 23 |
| Setting Limit | 24 |
| Measurement Example | 25 |
| Occupied Bandwidth..... | 26 |
| Measurement Procedure | 26 |
| Setting Limit | 28 |
| Measurement Example | 28 |

| | |
|---|----|
| Spectrum Emission Mask (SEM)..... | 29 |
| Measurement Procedure | 29 |
| Setting Limit | 31 |
| Measurement Example | 31 |
| Spurious Emissions | 32 |
| Measurement Procedure | 32 |
| Setting Limit | 34 |
| Measurement Example | 35 |
| Power vs Time (Frame) Measurement | 35 |
| Setting Mode | 35 |
| Setting Frequency | 36 |
| Setting Amplitude | 37 |
| Setting Sweep Mode | 38 |
| Setting Trigger Source | 39 |
| Setting External Clock..... | 39 |
| Measurement Procedure | 40 |
| Setting Limit | 42 |
| Measurement Example | 45 |
| Modulation Analysis Measurements..... | 46 |
| Setting Mode | 46 |
| Setting Frequency | 46 |
| Setting Amplitude | 48 |
| Setting Sweep Mode | 49 |
| Setting Trigger Source | 49 |
| Setting External Clock..... | 49 |
| Constellation..... | 51 |
| Measurement Procedure | 51 |
| Setting Limit | 53 |
| Measurement Example | 55 |
| Spectral Flatness..... | 55 |
| Measurement Procedure | 55 |
| Setting Limit | 57 |
| Measurement Example | 58 |
| EVM vs Subcarrier..... | 59 |
| Measurement Procedure | 59 |
| Setting Limit | 61 |
| Measurement Example | 63 |
| EVM vs Symbol | 63 |
| Measurement Procedure | 63 |
| Setting Limit | 65 |
| Measurement Example | 67 |
| Auto Measurement | 68 |
| Setting Mode | 68 |
| Setting Frequency | 68 |
| Setting Limit | 70 |
| Measurement Procedure | 71 |
| Setting Display | 73 |
| Power Statistics CCDF | 74 |
| Setting Mode | 74 |
| Setting Frequency | 74 |
| Setting Amplitude | 76 |
| Setting Sweep Mode | 76 |
| Setting Trigger Source | 77 |

| | |
|---|----|
| Setting External Clock..... | 77 |
| Measurement Procedure | 78 |
| Measurement Example | 79 |
| Mobile WiMAX OTA Measurements | 79 |
| Setting Mode | 80 |
| Setting Frequency | 80 |
| Setting Amplitude | 82 |
| Setting Sweep Mode | 83 |
| Setting Trigger Source | 83 |
| Setting External Clock..... | 83 |
| Mobile WiMAX OTA Preamble Scanner | 85 |
| Measurement Procedure | 85 |
| Measurement Example | 86 |
| Mobile WiMAX OTA Multipath Profile | 87 |
| Measurement Procedure | 87 |
| Measurement Example | 89 |
| Mobile WiMAX OTA Preamble Power Trend | 89 |
| Measurement Procedure | 89 |
| Measurement Example | 91 |
| Mobile WiMAX Route Map | 92 |
| Measurement Procedure | 92 |
| Setting Limit | 94 |
| Measurement Example | 95 |
| Analysis | 96 |
| Using Marker..... | 96 |
| Using Peak Search | 97 |

(Rev. 6.0)

USING MOBILE WiMAX SIGNAL ANALYZER

The Mobile WiMAX Signal Analyzer performs power and spectrum measurements as well as modulation analysis to test the proper transmitter performance of Mobile WiMAX systems. It performs conformance testing according to the following standards providing a simple Pass/Fail indication on each test.

- n IEEE 802.16e-2005
- n WiBro (Korean Mobile WiMAX OFDMA Service)

The Mobile WiMAX Signal Analyzer of the JD740AA series provides the following analysis tools for Mobile WiMAX system. The user may alter the measurement parameters for specialized analysis.

- n Spectrum Analysis
- n RF Analysis
 - Y Channel Power
 - Y Occupied Bandwidth
 - Y Spectrum Emission Mask
 - Y Spurious Emissions
- n Power vs Time (Frame)
- n Modulation Analysis
 - Y Constellation
 - Y Spectral Flatness
 - Y EVM vs Subcarrier
 - Y EVM vs Symbol
- n Auto Measure
- n Power Statistics CCDF
- n Over The Air (OTA)
 - Y Preamble Scanner
 - Y Multipath Profile
 - Y Preamble Power Trend
 - Y Route Map

DISPLAY OVERVIEW

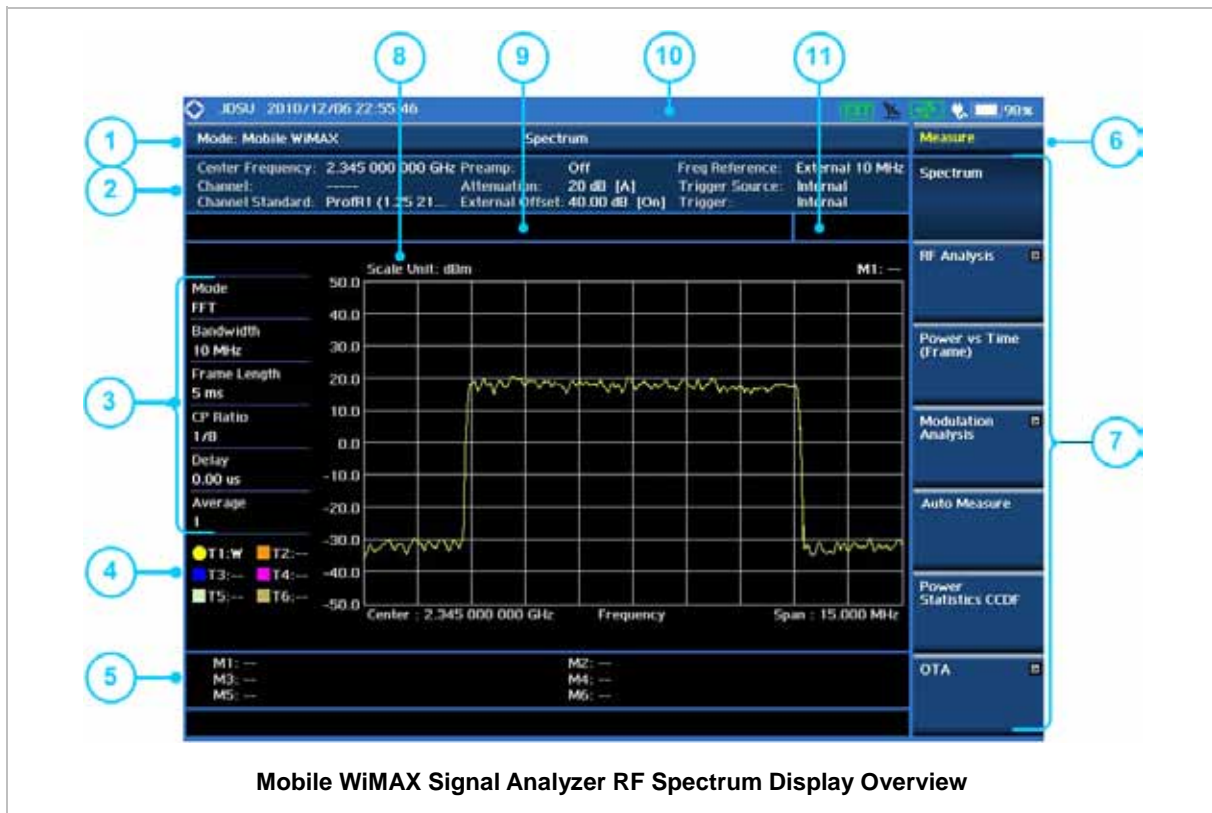

Measurement Mode Information: Mobile WiMAX Signal Analyzer

Spectrum Input Level Setting Information: This window shows the most common settings or parameters of each measurement.

- Frequency and Channel Setting
- Amplitude Setting (Preamp, Attenuation, External Offset)
- Reference Setting (Frequency, Trigger)

Measurement Setting Information

- Spectrum Analyzer Operation Mode Information
- Detector Type Setting Information
- Spectrum Setting Information (RBW, VBW)
- [A]: Auto mode, [M]: Manual mode
- Sweep Time Information: Displays current sweep time
- Average Number Information set through BW/AVG hard key. It shows the number of traces to be averaged.

Trace Information

- C: Captured
- M: Max Hold
- m: Min Hold
- W: Write Current Trace (Indicates current active trace)
- L: Loaded
- F: Trace View Off

Information on Marker Table displays up to 6 markers

Screen Menu Title

Screen Menu and Sub-menu

Scale Unit Information: dBm, dBV, dBmV, dBuV, V, and W

User Input Window: Activates when user input menu or key is selected. Pressing ESC hard key will cancel or deactivate user input window. Inactivate user input window before using hot keys.

NOTE: It is very important to inactivate the user input window when you intend to use the hot key menu on the numeric keys.

System Information

- Date and Time
- Positioning Information (Longitude and Latitude). It is available only when a GPS antenna is connected. Frequency reference is automatically set to GPS in the System menu when a GPS antenna is connected.
- Frequency Reference Indicator: INT for internal and EXT for external. The EXT icon is green when an external reference is locked or red when the external reference is not locked. When a GPS antenna is connected, this space will be blank.
- GPS Indicator: Color of the GPS icon changes among green, yellow and gray depending on locking status.
- USB Indicator
- DC Input Power Indicator
- Battery Indicator

Pass/Fail Indicator

CONNECTING A CABLE

Direct Connection

Connect the **Spectrum Analyzer RF In 50 Ω** port of the JD740A series and the PA output port of BTS.

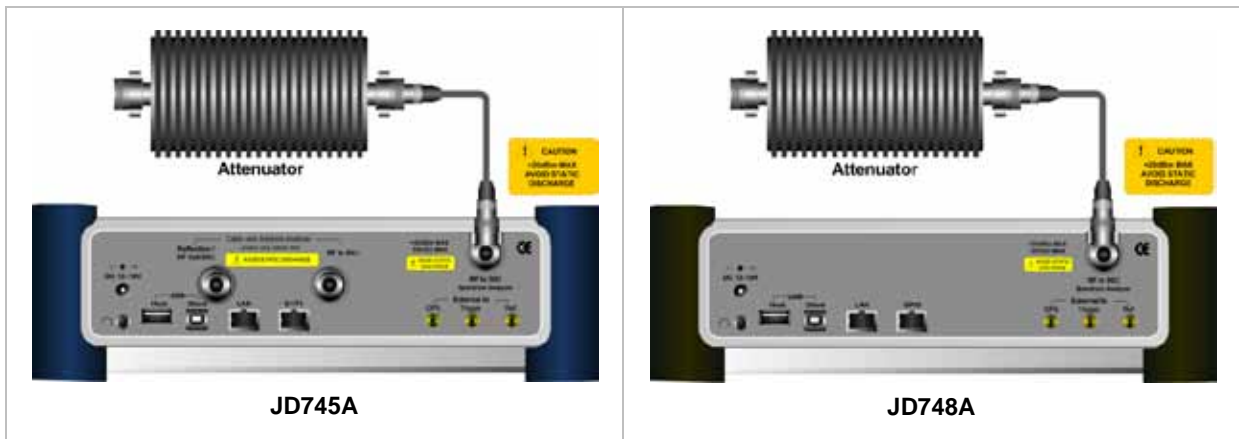

Indirect Connection

Connect the **Spectrum Analyzer RF In 50 Ω** port of the JD740A series and the monitor port of BTS.

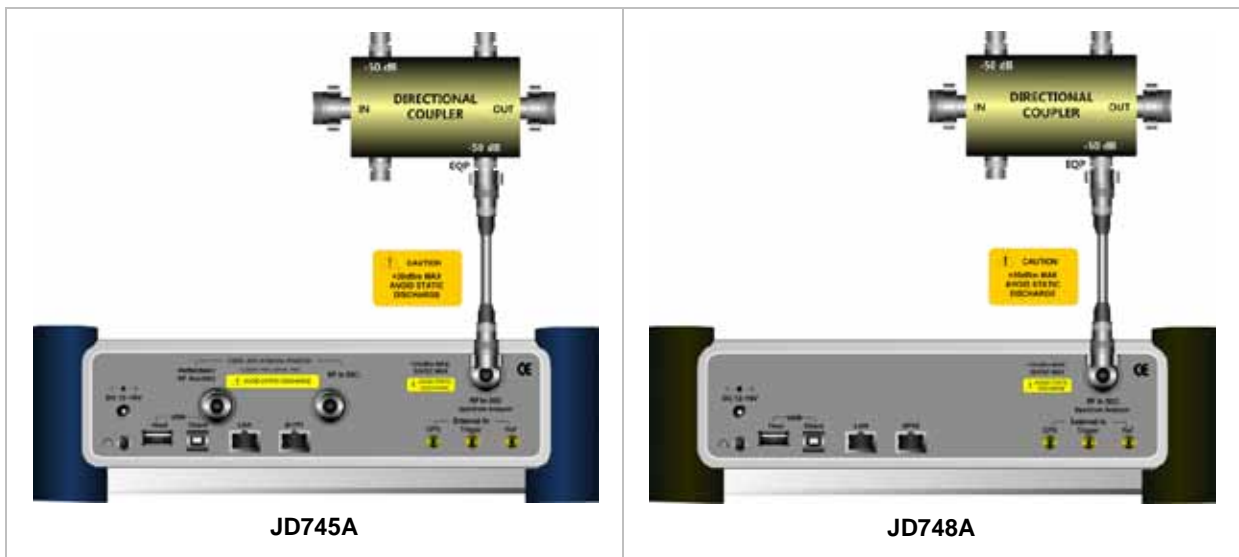

The maximum power for the **Spectrum Analyzer RF In 50 Ω** port is +20 dBm (0.1 Watt). If the input signal level to be measured is greater than +20 dBm, use a **High Power Attenuator** to prevent damage when you directly connect the signal to the instrument. Or connect a signal from the coupling port of a directional coupler.

Over The Air (OTA)

Connect an Omni/directional RF antenna to the **Spectrum Analyzer RF In 50 Ω** port of the JD740A series and then a GPS antenna to the **GPS** port of the JD740A series.

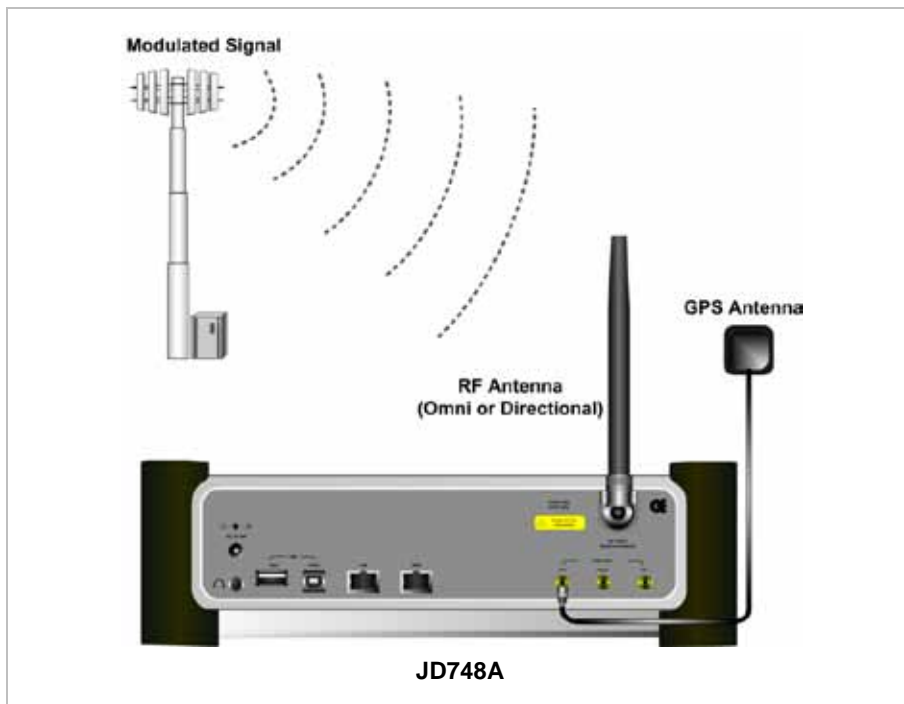
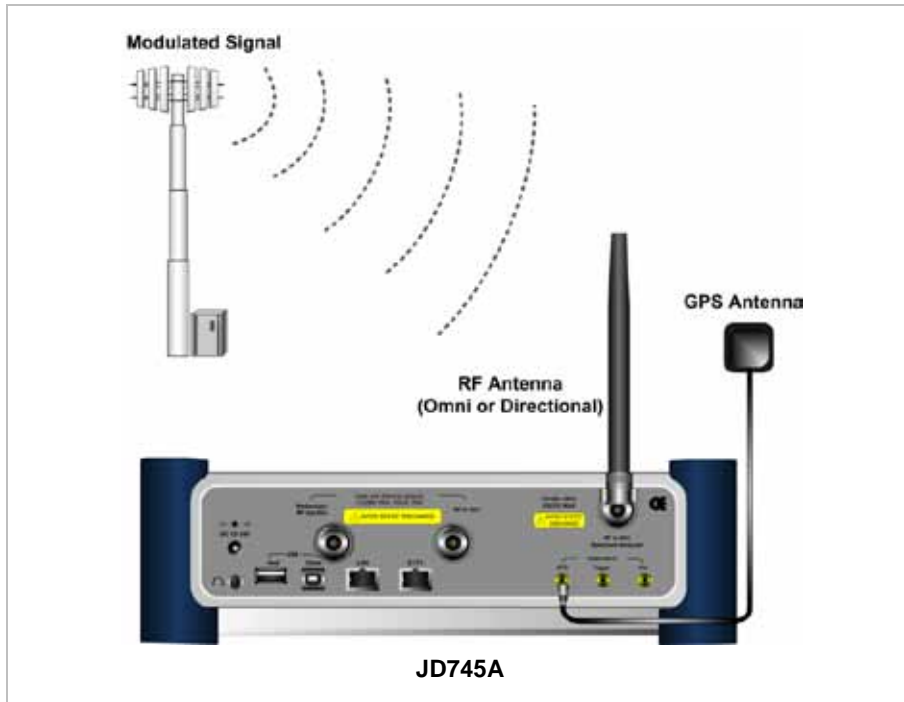

If the input signal level to be measured is less than 0 dBm, set 0 dB attenuation or turn on the preamp to have better dynamic range for the OTA testing.

SPECTRUM ANALYSIS MEASUREMENT

Setting Mode

| Step | Description |
|--|---|
| 1. Connect the cable | Connect a cable directly or indirectly as shown in the section Connecting a Cable on page 6 of this chapter. |
| 2. Select the mode MODE [Signal Analyzer] [More (1/2)] [Mobile WiMAX] [Spectrum] | Press the MODE hard key. Press the Signal Analyzer soft key. Press the More (1/2) soft key to get more soft keys. Press the Mobile WiMAX soft key. Press the Spectrum soft key. (Spectrum mode is set by default.) |

Setting Frequency

| Step | Description |
|--|---|
| 1. Set the frequency FREQ/DIST [Unit] <Freq> or <Channel> | Press the FREQ/DIST hard key. Press the Unit soft key. Toggle this key between Freq and Channel . A set of Freq/Dist screen menu changes accordingly. |
| <i>When Freq is selected:</i> [Center Frequency] Enter a value [GHz], [MHz], [kHz], or [Hz] | Press the Center Frequency soft key. Use the numeric keys, the rotary knob, or the arrow keys. When using the numeric keys, the input is completed by selecting one of the unit soft keys. |
| <i>When Channel is selected:</i> [Channel Standard] Select a channel standard [Select] or ENTER | Press the Channel Standard soft key. Press the arrow keys, rotate the knob, or press the Page Up and Page Down soft keys to highlight a frequency band to select. Press the Select soft key or the ENTER hard key. |
| [Channel Number] Enter a value [Forward] | Press the Channel Number soft key. Use the numeric keys to input value and press the Forward soft key to complete the input. The instrument automatically |

| | |
|--|---|
| | displays its corresponding center frequency value for the channel number. |
|--|---|

FREQ/DIST



- n **UNIT:** Determines the way how to set the frequency band either with standard band or custom frequency band. Toggling this key between **Freq** and **Channel** changes a set of Freq/Dist screen menu automatically.
- n **CENTER FREQUENCY:** Changes the center frequency setting. Use the rotary knob or the arrow keys. Or use the numeric keys to input a certain value and press one of the unit soft keys to complete the input.
- n **FREQUENCY STEP:** Defines the amount of frequency to be increased or decreased when using the rotary knob or the arrow keys to change the **Center Frequency**. This frequency step size can be entered by using numeric keys and the unit soft keys.
- n **CHANNEL NUMBER:** Enters a channel number. The instrument automatically displays its corresponding center frequency value for the channel number.
- n **CHANNEL STEP:** Defines the amount of channel to be increased or decreased when using the rotary knob or the arrow keys to change the **Channel Number**. This channel step size can be entered by using numeric keys and the **Enter** soft key.
- n **CHANNEL STANDARD:** When the channel standard is selected from the list, the center frequency information on the display screen will be mapped accordingly to the selected channel standard. The channel standards available in the instrument are listed in the Appendix C – Band, Frequency & Channel Standard.

Setting Amplitude

| Step | Description |
|---|--|
| 1. Set the reference/attenuation level AMP/SCALE [Auto Scale] | Press the AMP/SCALE hard key. Press the Auto Scale soft key to automatically set optimum levels of reference and attenuation. |
| or | |
| [Reference Level] Enter a reference level value | Press the Reference Level soft key to set manually. Use the numeric keys or the rotary knob that changes in a 10 dB step. |
| [dBm] or ENTER | Press the dBm soft key or the ENTER hard key. |

| | |
|--|---|
| <p>[Attenuation]</p> <p><Manual></p> <p>Enter an attenuation value</p> | <p>Press the Attenuation soft key. The Auto mode is set by default. This key toggles between the Auto and Manual.</p> <p>Press the Attenuation soft key to highlight the Manual mode and change the attenuation value to optimize S/N.</p> <p>Use the numeric keys or the rotary knob that changes in a 5 dB step. The attenuation setting range is 0 to 50 dB.</p> |
|--|---|

AMP/SCALE



- n **AUTO SCALE:** The instrument can automatically set the scale to the minimum and maximum values on the Y-axis of the graph for optimum display of the traces measured. Each time the **Auto Scale** is selected, the top and bottom scales are set to the minimum and maximum values with margin on the Y-axis of the display screen.
- n **REFERENCE LEVEL:** Sets the maximum Y-axis range when using the Spectrum Analyzer or Signal Analyzer function.
- n **SCALE/DIV:** Is used only for the Spectrum measurement screen. It represents the value of one division on the horizontal scale. The default value is 10 dB per division and the Y-Scale is set to 100 dB. Selecting the **Scale/Div** soft key enables to set the value to 1 dB per division with the numeric keys or the rotary knob.
- n **ATTENUATION**
 - Y **AUTO:** Input attenuator's value is automatically set depending on the reference level. This is the default operation mode, so it is recommended to use this mode unless a special measurement condition is needed.
 - Y **MANUAL:** Sets the attenuator's value for the **Spectrum Analyzer RF In 50 Ω** port.
- n **PREAMP:** Turns on or off the internal pre-amplifier. Preamp results in a correction being applied to compensate for the gain of the preamp so that amplitude readings show the value at the input connector. This soft key toggles between the **On** and **Off**. When it is set to On, the allowable attenuation input range is from 0 dB to 10 dB in a multiple of 5. If the attenuation value is manually set greater than 10 dB, the instrument will automatically turn off the pre-amplifier to display low level signal properly on the screen.
- n **UNITS:** Sets the scale unit on the display among **dBm**, **dBV**, **dBmV**, **dBuV**, **V**, and **W**.
- n **EXTERNAL OFFSET:** Sets an external offset value. An offset consists of a cable loss and a user offset and the measurement result shows the value reflecting both offset values. When the external offset value is set at 40 dB in the Spectrum mode, the measurement result compensates 40 dB at both the Spectrum Analyzer and Signal Analyzer modes.

Setting Averaging

BW/AVG



- n **AVERAGE:** Sets the number of measurements to be averaged for the trace presentation. A maximum of 100 times of averaging can be set.

| Step | Description |
|---|---|
| 1. Set the averaging BW/AVG [Average] | Press the BW/AVG hard key. Press the Average soft key. |
| 2. Enter number of averaging to set | Use the numeric keys and input a number between 1 and 100. When the averaging reaches to the number set here, a new measurement value replaces the earliest measurement value in sequence. |
| 3. [Enter] or ENTER | Press the Enter soft key or the ENTER hard key. |

Setting Sweep Mode

SWEEP



This hot key is used to set the sweep parameters. The user input window must be inactive first to get the Sweep hot key function other than the number input.

- n **SWEEP MODE:** Sets the sweep method. Toggle between **Continue** and **Single**.

| Step | Description |
|--|---|
| 1. Set the sweep mode SWEEP [Sweep Mode] | Press the SWEEP hot key. Press the Sweep Mode soft key. Toggle between Continue and Single . |

Setting Trigger Source

TRIGGER



This hot key is used to select the trigger source among **Internal**, **External**, and **GPS**. The user input window must be inactive first to get the Trigger hot key function other than the number input.

Setting External Clock

To enhance the reliability of modulation analysis measurements the JD740A series must be synchronized with the Base Station. When an external clock is not supplied, the JD740A series works with a built-in internal high-accuracy time base. In this case, some measurement results may exhibit inaccurate values. Therefore, it is highly recommended to use the same reference clock as signal source. Trigger mode can be changed by using the **TRIGGER** hot key.

EXTERNAL CLOCK OPERATING STANDARDS

| Clock | Type | Reference | Port | Switching Standard |
|--------------------|----------|--------------------|---------------|--|
| External Reference | Internal | Internal 10 MHz | | Default |
| | External | External Ref Clock | Ext Ref (SMA) | Manual switching (Input signal level >-3 dBm) |
| | GPS | GPS Clock | GPS (SMA) | Automatic switching (GPS signal received) |
| Trigger | Internal | Internal Trigger | | Default |
| | External | External Trigger | Trigger (SMA) | Manual switching |
| | GPS | GPS | GPS (SMA) | Manual switching |

CONNECTION

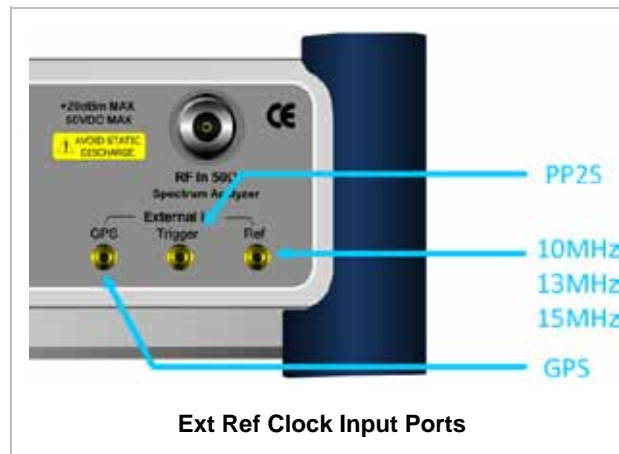

ENABLING EXTERNAL REFERENCE

| Step | Description |
|----------------------------------|---|
| 1. Connect an external reference | Connect one of the external references or a GPS antenna to the JD740A series. |

| | |
|--|---|
| <p>2. Change reference clock</p> <p>SYSTEM</p> <p>[Frequency Reference]</p> <p>[External 10 MHz], [External 13 MHz], [External 15 MHz], or [GPS]</p> | <p>Press the SYSTEM hot key.</p> <p>Press the Frequency Reference soft key to select one of the external reference clocks or GPS.</p> <p>Press one of the soft keys to choose among External 10 MHz, External 13 MHz, External 15 MHz, and GPS.</p> |
|--|---|

EXTERNAL REFERENCE INDICATOR INFORMATION

Each indicator tells different locking status according to a connection. When a GPS antenna is connected, longitude and latitude information will be displayed on the screen.

| Type | Indicator | Description |
|----------|--|----------------------------------|
| Internal |  (Green) | Locked |
| External |  (Green) | Locked |
| |  (Red) | Unlocked |
| GPS |  (Green) | Locked |
| |  (Yellow) | Locking in progress |
| |  (Gray) | Unable to lock or antenna failed |

Setting Trace and Display

TRACE/DISPLAY

- n **SELECT TRACE:** Selects an active trace from T1 to T6. Trace numbers are assigned to each captured trace or loaded trace. Pressing one of the 6 trace number soft keys sets the selected trace number as the active trace on the display screen.
- n **CLEAR WRITE:** Clears the selected trace and writes or assigns the current trace.
- n **MAX HOLD:** Sets the active trace to display the maximum response of the input signal. Active trace compares newly acquired data with the trace shown on the screen and displays the bigger trace on the display screen.
- n **MIN HOLD:** Sets the active trace to display the minimum response of the input signal. Active trace compares newly acquired data with the trace shown on the screen and displays the smaller trace on the display screen.
- n **CAPTURE:** Captures a current trace on the display screen with the selected trace number.
- n **TRACE VIEW:** Displays the trace of the selected trace number on the display screen or hides it

from the display screen. Press the **Select Trace** soft key to select a trace number and then press the **Trace View** soft key to toggle between the **Off** to hide and **On** to restore a hidden trace.

- n **TRACE CLEAR ALL:** Deletes all traces from the instrument and initializes the trace settings.

Measurement Procedure

| Step | Description |
|---|---|
| 1. Select the measurement mode MEASURE [Spectrum] | Press the MEASURE hot key. Press the Spectrum soft key. |
| 2. Set the measurement parameters MEASURE SETUP [System Config] [Bandwidth] [7 MHz (8/7)], [8.75 MHz (8/7)], or [10 MHz (28/25)] [Frame Length] <5 ms> or <10 ms> [TTG (RTG)] Enter a value [uSec] [CP Ratio] <1/32>, <1/16>, <1/8>, or <1/4> [DL Symbols] Enter a value [Enter] [UL Symbols] Enter a value [Enter] | Press the MEASURE SETUP hot key. Press the System Config soft key. Press the Bandwidth soft key. Press one of the soft keys to select. Press the Frame Length soft key. Toggle between 5 ms and 10 ms to select one. Press the TTG (RTG) soft key. Use the numeric keys to input value. Press the unit soft key to complete the input. Press the CP Ratio soft key. Each time this soft key is pressed the selection moves. Press the DL Symbols soft key. Use the numeric keys to input value. Press the Enter soft key to complete the input. Press the UL Symbols soft key. Use the numeric keys to input value. Press the Enter soft key to complete the input. |

Mobile WiMAX Spectrum Measurement Procedure

MEASURE SETUP



- n **SYSTEM CONFIG:** Sets the system configuration.

Y **BANDWIDTH:** Selects the nominal channel bandwidths to be measured.

- **7 MHz (8/7):** Sets the channel bandwidth to 7 MHz with sampling factor 8/7. In conjunction with nominal channel bandwidth.
- **8.75 MHz (8/7):** Sets the channel bandwidth to 8.75 MHz with sampling factor 8/7.

- **10 MHz (28/25):** Sets the channel bandwidth to 10 MHz with sampling factor 28/25.
- Y **FRAME LENGTH:** Sets the length of a frame. Toggle this soft key between **5 ms** and **10 ms**.
- Y **TTG (RTG):** Sets the transmit/receive transition gap between the last sample of the downlink (DL) burst and the first sample of the subsequent uplink (UL) burst.
- Y **CP RATIO:** Sets the Cyclic Prefix (CP) ratio among **1/4**, **1/8**, **1/16**, and **1/32**. Each time this soft key is pressed the selection moves. A copy of the last Tg of the useful symbol period, termed CP, is used to collect multipath, while maintaining the orthogonality of the tones.
- Y **DL SYMBOLS:** Sets the number of downlink symbols.
- Y **UL SYMBOLS:** Sets the number of uplink symbols.
- n **DELAY:** Sets the delay in micro seconds. This key is used only when there is a time offset in the signals to be measured.
- n **START SYMBOL:** *This key is not applicable to the Spectrum mode.*
- n **STOP SYMBOL:** *This key is not applicable to the Spectrum mode.*

Measurement Example

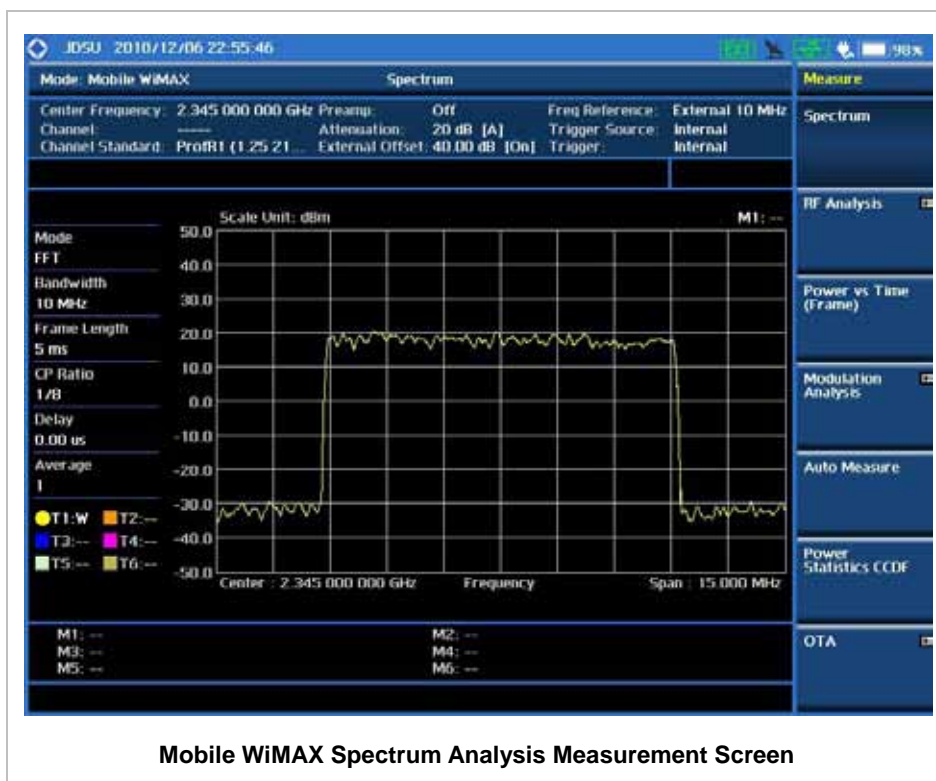

RF ANALYSIS MEASUREMENTS

RF Analysis in Mobile WiMAX Signal Analyzer provides single-button measurements for the following measurements.

- n Channel Power
- n Occupied Bandwidth
- n Spectrum Emission Mask
- n Spurious Emissions

Setting Mode

| Step | Description |
|---|---|
| 1. Connect the cable | Connect a cable directly or indirectly as shown in the section Connecting a Cable on page 6 of this chapter. |
| 2. Select the mode MODE [Signal Analyzer] [More (1/2)] [Mobile WiMAX] [RF Analysis] [Channel Power], [Occupied BW], [Spectrum Emission Mask], or [Spurious Emissions] | Press the MODE hard key. Press the Signal Analyzer soft key. Press the More (1/2) soft key to get more soft keys. Press the Mobile WiMAX soft key. Press the RF Analysis soft key. Press one of the measurement mode soft keys to select. |

Setting Frequency

This setting is not used in the Spurious Emissions mode.

| Step | Description |
|---|--|
| 1. Set the frequency FREQ/DIST [Unit] <Freq> or <Channel> | Press the FREQ/DIST hard key. Press the Unit soft key. Toggle this key between Freq and Channel . A set of Freq/Dist screen menu changes accordingly. |

| | |
|--|--|
| <p><u>When Freq is selected:</u></p> <p>[Center Frequency] Enter a value [GHz], [MHz], [kHz], or [Hz]</p> | <p>Press the Center Frequency soft key. Use the numeric keys, the rotary knob, or the arrow keys. When using the numeric keys, the input is completed by selecting one of the unit soft keys.</p> |
| <p><u>When Channel is selected:</u></p> <p>[Channel Standard] Select a channel standard</p> <p>[Select] or ENTER</p> | <p>Press the Channel Standard soft key. Press the arrow keys, rotate the knob, or press the Page Up and Page Down soft keys to highlight a frequency band to select. Press the Select soft key or the ENTER hard key.</p> |
| <p>[Channel Number] Enter a value [Forward]</p> | <p>Press the Channel Number soft key. Use the numeric keys to input value and press the Forward soft key to complete the input. The instrument automatically displays its corresponding center frequency value for the channel number.</p> |

FREQ/DIST



- n **UNIT:** Determines the way how to set the frequency band either with standard band or custom frequency band. Toggling this key between **Freq** and **Channel** changes a set of Freq/Dist screen menu automatically.
- n **CENTER FREQUENCY:** Changes the center frequency setting. Use the rotary knob or the arrow keys. Or use the numeric keys to input a certain value and press one of the unit soft keys to complete the input.
- n **FREQUENCY STEP:** Defines the amount of frequency to be increased or decreased when using the rotary knob or the arrow keys to change the **Center Frequency**. This frequency step size can be entered by using numeric keys and the unit soft keys.
- n **CHANNEL NUMBER:** Enters a channel number. The instrument automatically displays its corresponding center frequency value for the channel number.
- n **CHANNEL STEP:** Defines the amount of channel to be increased or decreased when using the rotary knob or the arrow keys to change the **Channel Number**. This channel step size can be entered by using numeric keys and the **Enter** soft key.
- n **CHANNEL STANDARD:** When the channel standard is selected from the list, the center frequency information on the display screen will be mapped accordingly to the selected channel standard. The channel standards available in the instrument are listed in the Appendix C – Band, Frequency & Channel Standard.

Setting Amplitude

| Step | Description |
|--|---|
| 1. Set the reference/attenuation level | |
| AMP/SCALE | Press the AMP/SCALE hard key. |
| [Auto Scale] | Press the Auto Scale soft key to automatically set optimum levels of reference and attenuation. |
| or | |
| [Reference Level] | Press the Reference Level soft key to set manually. |
| Enter a reference level value | Use the numeric keys or the rotary knob that changes in a 10 dB step. |
| [dBm] or ENTER | Press the dBm soft key or the ENTER hard key. |
| [Attenuation] | Press the Attenuation soft key. The Auto mode is set by default. This key toggles between the Auto and Manual . |
| <Manual> | Press the Attenuation soft key to highlight the Manual mode and change the attenuation value to optimize S/N. |
| Enter an attenuation value | Use the numeric keys or the rotary knob that changes in a 5 dB step. The attenuation setting range is 0 to 50 dB. |

AMP/SCALE



- n **AUTO SCALE:** The instrument can automatically set the scale to the minimum and maximum values on the Y-axis of the graph for optimum display of the traces measured. Each time the **Auto Scale** is selected, the top and bottom scales are set to the minimum and maximum values with margin on the Y-axis of the display screen.
- n **REFERENCE LEVEL:** Sets the maximum Y-axis range.
- n **SCALE/DIV:** Is used only for the Spectrum measurement screen. It represents the value of one division on the horizontal scale. The default value is 10 dB per division and the Y-Scale is set to 100 dB. Selecting the **Scale/Div** soft key enables to set the value to 1 dB per division with the numeric keys or the rotary knob.
- n **ATTENUATION**
 - Y **AUTO:** Input attenuator's value is automatically set depending on the reference level. This is the default operation mode, so it is recommended to use this mode unless a special measurement condition is needed.
 - Y **MANUAL:** Sets the attenuator's value for the **Spectrum Analyzer RF In 50 Ω** port.

- n **PREAMP:** Turns on or off the internal pre-amplifier. Preamp results in a correction being applied to compensate for the gain of the preamp so that amplitude readings show the value at the input connector. This soft key toggles between the **On** and **Off**. When it is set to On, the allowable attenuation input range is from 0 dB to 10 dB in a multiple of 5. If the attenuation value is manually set greater than 10 dB, the instrument will automatically turn off the pre-amplifier to display low level signal properly on the screen.
- n **UNITS:** Sets the scale unit on the display among **dBm**, **dBV**, **dBmV**, **dBuV**, **V**, and **W**.
- n **EXTERNAL OFFSET:** Sets an external offset value. An offset consists of a cable loss and a user offset and the measurement result shows the value reflecting both offset values. When the external offset value is set at 40 dB in the Spectrum mode, the measurement result compensates 40 dB at both the Spectrum Analyzer and Signal Analyzer modes.

Setting Averaging



- n **AVERAGE:** Sets the number of measurements to be averaged for the trace presentation. A maximum of 100 times of averaging can be set. *This setting is not used in the Spurious Emissions mode.*

| Step | Description |
|---|--|
| 1. Set the averaging BW/AVG [Average] | Press the BW/AVG hard key. Press the Average soft key. |
| 2. Enter number of averaging to set | Use the numeric keys and input a number between 1 and 100. When the averaging reaches to the number set here, a new measurement value replaces the earliest measurement value in sequence. |
| 3. [Enter] or ENTER | Press the Enter soft key or the ENTER hard key. |

Setting Sweep Mode



This hot key is used to set the sweep parameters. The user input window must be inactive first to get the Sweep hot key function other than the number input.

- n **SWEEP MODE:** Sets the sweep method. Toggle between **Continue** and **Single**.

| Step | Description |
|---|---|
| 1. Set the sweep mode SWEEP [Sweep Mode] | Press the SWEEP hot key. Press the Sweep Mode soft key. Toggle between Continue and Single . |

Setting Trigger Source



This hot key is used to select the trigger source among **Internal**, **External**, and **GPS**. The user input window must be inactive first to get the Trigger hot key function other than the number input.

Setting External Clock

To enhance the reliability of modulation analysis measurements the JD740A series must be synchronized with the Base Station. When an external clock is not supplied, the JD740A series works with a built-in internal high-accuracy time base. In this case, some measurement results may exhibit inaccurate values. Therefore, it is highly recommended to use the same reference clock as signal source. Trigger mode can be changed by using the **TRIGGER** hot key.

EXTERNAL CLOCK OPERATING STANDARDS

| Clock | Type | Reference | Port | Switching Standard |
|--------------------|----------|--------------------|---------------|--|
| External Reference | Internal | Internal 10 MHz | | Default |
| | External | External Ref Clock | Ext Ref (SMA) | Manual switching (Input signal level >-3 dBm) |
| | GPS | GPS Clock | GPS (SMA) | Automatic switching (GPS signal received) |
| Trigger | Internal | Internal Trigger | | Default |
| | External | External Trigger | Trigger (SMA) | Manual switching |
| | GPS | GPS | GPS (SMA) | Manual switching |

CONNECTION

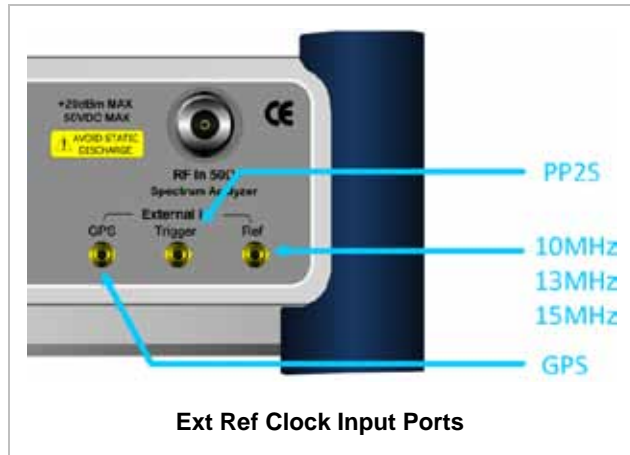







ENABLING EXTERNAL REFERENCE

| Step | Description |
|---|--|
| 1. Connect an external reference | Connect one of the external references or a GPS antenna to the JD740A series. |
| 2. Change reference clock SYSTEM [Frequency Reference] [External 10 MHz], [External 13 MHz], [External 15 MHz] or [GPS] | Press the SYSTEM hot key. Press the Frequency Reference soft key to select one of the external reference clocks or GPS. Press one of the soft keys to choose among External 10 MHz , External 13 MHz , External 15 MHz , and GPS . |

EXTERNAL REFERENCE INDICATOR INFORMATION

Each indicator tells different locking status according to a connection. When a GPS antenna is connected, longitude and latitude information will be displayed on the screen.

| Type | Indicator | Description |
|----------|--|----------------------------------|
| Internal |  (Green) | Locked |
| External |  (Green) | Locked |
| |  (Red) | Unlocked |
| GPS |  (Green) | Locked |
| |  (Yellow) | Locking in progress |
| |  (Gray) | Unable to lock or antenna failed |

CHANNEL POWER

The Channel Power measurement is a common test used in the wireless industry to measure the total transmitted power of a radio within a defined frequency channel. It acquires a number of points representing the input signal in the time domain, transforms this information into the frequency domain using Fast Fourier Transform (FFT) and then calculates the channel power. The effective resolution bandwidth of the frequency domain trace is proportional to the number of points acquired for the FFT.

The channel power measurement identifies the total RF power, power spectral density (PSD) and peak to average ratio (PAR) of the signal in the Mobile WiMAX channel bandwidth.

Measurement Procedure

| Step | Description |
|---|---|
| 1. Set the measurement mode MEASURE [RF Analysis] [Channel Power] | Press the MEASURE hot key. Press the RF Analysis soft key. Press the Channel Power soft key. |
| 2. Set the measurement parameters MEASURE SETUP [System Config] [Bandwidth] [7 MHz (8/7)], [8.75 MHz (8/7)], or [10 MHz (28/25)] [Frame Length] <5 ms> or <10 ms> [TTG (RTG)] Enter a value [uSec] [CP Ratio] <1/32>, <1/16>, <1/8>, or <1/4> [DL Symbols] Enter a value [Enter] [UL Symbols] Enter a value [Enter] [Start Symbol] | Press the MEASURE SETUP hot key. Press the System Config soft key. Press the Bandwidth soft key. Press one of the soft keys to select the bandwidth. Press the Frame Length soft key. Toggle between 5 ms and 10 ms to select one. Press the TTG (RTG) soft key. Use the numeric keys to input value. Press the unit soft key to complete the input. Press the CP Ratio soft key. Each time the soft key is pressed the selection moves. Press the DL Symbols soft key. Use the numeric keys to input value. Press the Enter soft key to complete the input. Press the UL Symbols soft key. Use the numeric keys to input value. Press the Enter soft key to complete the input. Press the Start Symbol soft key. |

| | |
|---|--|
| Enter a value [Enter] | Use the numeric keys to input value. Press the Enter soft key to complete the input. |
| [Stop Symbol] Enter a value [Enter] | Press the Stop Symbol soft key. Use the numeric keys to input value. Press the Enter soft key to complete the input. |

Mobile WiMAX Channel Power Measurement Procedure

MEASURE SETUP



- n **SYSTEM CONFIG:** Sets the system configuration.
- Y **BANDWIDTH:** Selects the nominal channel bandwidths to be measured.
 - **7 MHz (8/7):** Sets the channel bandwidth to 7 MHz with sampling factor 8/7. In conjunction with nominal channel bandwidth.
 - **8.75 MHz (8/7):** Sets the channel bandwidth to 8.75 MHz with sampling factor 8/7.
 - **10 MHz (28/25):** Sets the channel bandwidth to 10 MHz with sampling factor 28/25.
- Y **FRAME LENGTH:** Sets the length of a frame. Toggle this soft key between **5 ms** and **10 ms**.
- Y **TTG (RTG):** Sets the transmit/receive transition gap between the last sample of the downlink (DL) burst and the first sample of the subsequent uplink (UL) burst.
- Y **CP RATIO:** Sets the Cyclic Prefix (CP) ratio among **1/4**, **1/8**, **1/16**, and **1/32**. Each time this soft key is pressed the selection moves. A copy of the last Tg of the useful symbol period, termed CP, is used to collect multipath, while maintaining the orthogonality of the tones.
- Y **DL SYMBOLS:** Sets the number of downlink symbols.
- Y **UL SYMBOLS:** Sets the number of uplink symbols.
- n **DELAY:** Sets the delay in micro seconds. This key is used only when there is a time offset in the signals to be measured.
- n **START SYMBOL:** Sets the start symbol.
- n **STOP SYMBOL:** Sets the stop symbol.

Setting Limit

LIMIT



This hot key is used to set the threshold value for the limit line on the display screen. It turns on or off the limit or band limit settings of the measurement for pass/fail indication. The user input window must

be inactive first to get the Limit hot key function other than the number input.

| Step | Description |
|---|---|
| 1. Select the limit LIMIT [RF Test Limits] [Channel Power] [Test Limits] <On> or <Off> [High Limit] Enter a value [dBm] or ENTER [Low Limit] Enter a value [dBm] or ENTER | Press the LIMIT hot key. Press the RF Test Limits soft key. Press the Channel Power soft key. Press the Test Limits soft key to toggle between On and Off and select one. Press the High Limit soft key to set the upper limit of the Pass/Fail criteria. Use the numeric keys to input value. Press the unit soft key or the ENTER hard key. Press the Low Limit soft key to set the lower limit of the Pass/Fail criteria. Use the numeric keys to input value. Press the unit soft key or the ENTER hard key. |
| 2. Enable beep LIMIT [Beep] <On> or <Off> | Press the LIMIT hot key. Press the Beep soft key to toggle between On and Off and select one. This will make audible alarm if the measurement result goes beyond the limit. |

- n **TEST LIMITS:** Enables or disables Pass/Fail results on the display screen. Toggle the **Test Limits** soft key to set it to **On** or **Off**.
- n **HIGH LIMIT:** Sets the upper limit of the Pass/Fail criteria. Use the numeric keys to enter a threshold or limit value and press the **dBm** unit soft key or the **ENTER** hard key to complete the input.
- n **LOW LIMIT:** Sets the lower limit of the Pass/Fail criteria. Use the numeric keys to enter a threshold or limit value and press the **dBm** unit soft key or the **ENTER** hard key to complete the input.

Measurement Example



Mobile WiMAX Channel Power Measurement Screen

OCCUPIED BANDWIDTH

The Occupied Bandwidth measures the spectrum shape of the carrier. It is defined as the bandwidth which includes 99% of the transmitted power among total transmitted power.

Measurement Procedure

| Step | Description |
|---|--|
| 1. Set the measurement mode MEASURE [RF Analysis] [Occupied BW] | Press the MEASURE hot key. Press the RF Analysis soft key. Press the Occupied BW soft key. |
| 2. Set the measurement parameters MEASURE SETUP [System Config] [Bandwidth] [7 MHz (8/7)], [8.75 MHz (8/7)], or [10 MHz (28/25)] | Press the MEASURE SETUP hot key. Press the System Config soft key. Press the Bandwidth soft key. Press one of the soft keys to select the bandwidth. |

| | |
|--|--|
| <p>[Frame Length] <5 ms> or <10 ms></p> <p>[TTG (RTG)] Enter a value</p> <p>[uSec]</p> <p>[CP Ratio] <1/32>, <1/16>, <1/8>, or <1/4></p> <p>[DL Symbols] Enter a value</p> <p>[Enter]</p> <p>[UL Symbols] Enter a value</p> <p>[Enter]</p> <p>[Start Symbol] Enter a value</p> <p>[Enter]</p> <p>[Stop Symbol] Enter a value</p> <p>[Enter]</p> | <p>Press the Frame Length soft key. Toggle between 5 ms and 10 ms to select one.</p> <p>Press the TTG (RTG) soft key.</p> <p>Use the numeric keys to input value.</p> <p>Press the unit soft key to complete the input.</p> <p>Press the CP Ratio soft key. Each time the soft key is pressed the selection moves.</p> <p>Press the DL Symbols soft key.</p> <p>Use the numeric keys to input value.</p> <p>Press the Enter soft key to complete the input.</p> <p>Press the UL Symbols soft key.</p> <p>Use the numeric keys to input value.</p> <p>Press the Enter soft key to complete the input.</p> <p>Press the Start Symbol soft key.</p> <p>Use the numeric keys to input value.</p> <p>Press the Enter soft key to complete the input.</p> <p>Press the Stop Symbol soft key.</p> <p>Use the numeric keys to input value.</p> <p>Press the Enter soft key to complete the input.</p> |
|--|--|

Mobile WiMAX Occupied BW Measurement Procedure

MEASURE SETUP



- n **SYSTEM CONFIG:** Sets the system configuration.
- Y **BANDWIDTH:** Selects the nominal channel bandwidths to be measured.
 - **7 MHz (8/7):** Sets the channel bandwidth to 7 MHz with sampling factor 8/7. In conjunction with nominal channel bandwidth.
 - **8.75 MHz (8/7):** Sets the channel bandwidth to 8.75 MHz with sampling factor 8/7.
 - **10 MHz (28/25):** Sets the channel bandwidth to 10 MHz with sampling factor 28/25.
- Y **FRAME LENGTH:** Sets the length of a frame. Toggle this soft key between **5 ms** and **10 ms**.
- Y **TTG (RTG):** Sets the transmit/receive transition gap between the last sample of the downlink (DL) burst and the first sample of the subsequent uplink (UL) burst.
- Y **CP RATIO:** Sets the Cyclic Prefix (CP) ratio among **1/4**, **1/8**, **1/16**, and **1/32**. Each time this soft key is pressed the selection moves. A copy of the last Tg of the useful symbol period, termed CP, is used to collect multipath, while maintaining the orthogonality of the tones.
- Y **DL SYMBOLS:** Sets the number of downlink symbols.

- Y **UL SYMBOLS:** Sets the number of uplink symbols.
- n **DELAY:** Sets the delay in micro seconds. This key is used only when there is a time offset in the signals to be measured.
- n **START SYMBOL:** Sets the start symbol.
- n **STOP SYMBOL:** Sets the stop symbol.

Setting Limit



This hot key is used to set the threshold value for the limit line on the display screen. It turns on or off the limit or band limit settings of the measurement for pass/fail indication. The user input window must be inactive first to get the Limit hot key function other than the number input.

| Step | Description |
|--|--|
| 1. Select the limit LIMIT [RF Test Limits] [Occupied BW] [Test Limit] <On> or <Off> [High Limit] Enter a value [MHz], [kHz], or [Hz] | Press the LIMIT hot key. Press the RF Test Limits soft key. Press the Occupied BW soft key. Press the Test Limit soft key to toggle between On and Off and select one. Press the High Limit soft key to set the upper limit of the Pass/Fail criteria. Use the numeric keys to input value. Press the unit soft key to select. |
| 2. Enable beep LIMIT [Beep] <On> or <Off> | Press the LIMIT hot key. Press the Beep soft key to toggle between On and Off and select one. This will make audible alarm if the measurement result goes beyond the limit. |

- n **TEST LIMIT:** Enables or disables Pass/Fail results on the display screen. Toggle the **Test Limit** soft key to set it to **On** or **Off**.
- n **HIGH LIMIT:** Sets the upper limit of the Pass/Fail criteria. Use the numeric keys to enter a threshold or limit value and press one of the unit soft keys to complete the input.

Measurement Example

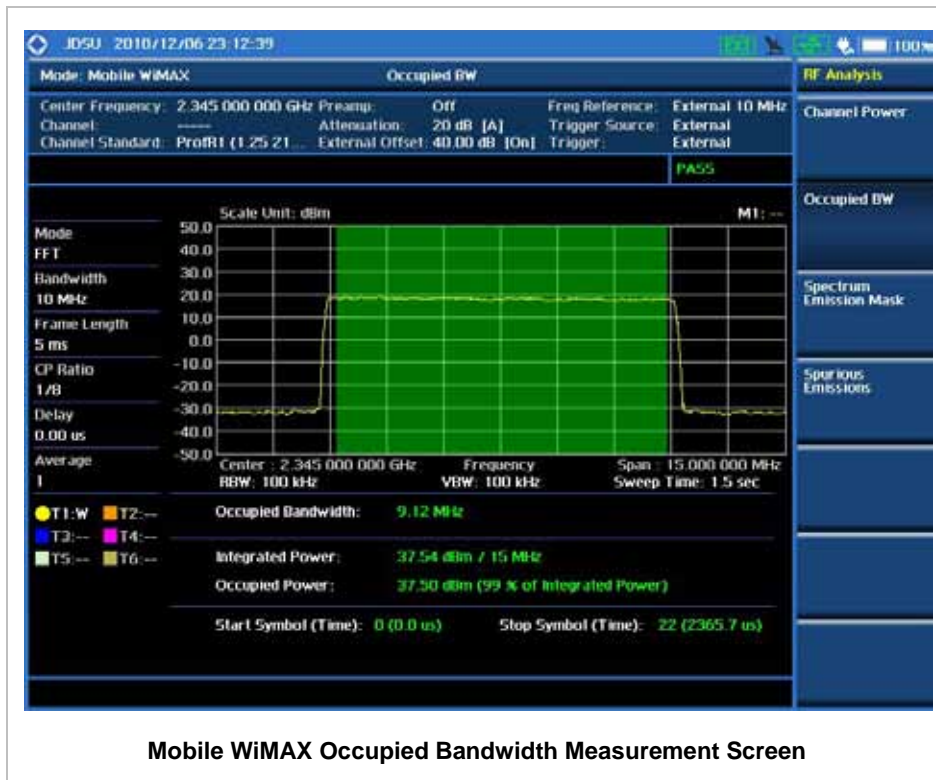

Mobile WiMAX Occupied Bandwidth Measurement Screen

SPECTRUM EMISSION MASK (SEM)

The Spectrum Emission Mask (SEM) measurement compares the total power level within the defined carrier bandwidth and the given offset channels according to the standards.

Measurement Procedure

| Step | Description |
|---|--|
| 1. Set the measurement mode MEASURE [RF Analysis] [Spectrum Emission Mask] | Press the MEASURE hot key. Press the RF Analysis soft key. Press the Spectrum Emission Mask soft key. |
| 2. Set the measurement parameters MEASURE SETUP [System Config] [Bandwidth] [7 MHz (8/7)], [8.75 MHz (8/7)], or [10 MHz (28/25)] | Press the MEASURE SETUP hot key. Press the System Config soft key. Press the Bandwidth soft key. Press one of the soft keys to select the bandwidth. |

| | |
|--|--|
| <p>[Frame Length] <5 ms> or <10 ms></p> <p>[TTG (RTG)] Enter a value</p> <p>[uSec]</p> <p>[CP Ratio] <1/32>, <1/16>, <1/8>, or <1/4></p> <p>[DL Symbols] Enter a value</p> <p>[Enter]</p> <p>[UL Symbols] Enter a value</p> <p>[Enter]</p> <p>[Start Symbol] Enter a value</p> <p>[Enter]</p> <p>[Stop Symbol] Enter a value</p> <p>[Enter]</p> | <p>Press the Frame Length soft key. Toggle between 5 ms and 10 ms to select one.</p> <p>Press the TTG (RTG) soft key.</p> <p>Use the numeric keys to input value.</p> <p>Press the unit soft key to complete the input.</p> <p>Press the CP Ratio soft key. Each time the soft key is pressed the selection moves.</p> <p>Press the DL Symbols soft key.</p> <p>Use the numeric keys to input value.</p> <p>Press the Enter soft key to complete the input.</p> <p>Press the UL Symbols soft key.</p> <p>Use the numeric keys to input value.</p> <p>Press the Enter soft key to complete the input.</p> <p>Press the Start Symbol soft key.</p> <p>Use the numeric keys to input value.</p> <p>Press the Enter soft key to complete the input.</p> <p>Press the Stop Symbol soft key.</p> <p>Use the numeric keys to input value.</p> <p>Press the Enter soft key to complete the input.</p> |
|--|--|

Mobile WiMAX Spectrum Emission Mask Measurement Procedure

MEASURE SETUP



- n **SYSTEM CONFIG:** Sets the system configuration.
- Y **BANDWIDTH:** Selects the nominal channel bandwidths to be measured.
 - **7 MHz (8/7):** Sets the channel bandwidth to 7 MHz with sampling factor 8/7. In conjunction with nominal channel bandwidth.
 - **8.75 MHz (8/7):** Sets the channel bandwidth to 8.75 MHz with sampling factor 8/7.
 - **10 MHz (28/25):** Sets the channel bandwidth to 10 MHz with sampling factor 28/25.
- Y **FRAME LENGTH:** Sets the length of a frame. Toggle this soft key between **5 ms** and **10 ms**.
- Y **TTG (RTG):** Sets the transmit/receive transition gap between the last sample of the downlink (DL) burst and the first sample of the subsequent uplink (UL) burst.
- Y **CP RATIO:** Sets the Cyclic Prefix (CP) ratio among **1/4**, **1/8**, **1/16**, and **1/32**. Each time this soft key is pressed the selection moves. A copy of the last Tg of the useful symbol period, termed CP, is used to collect multipath, while maintaining the orthogonality of the tones.
- Y **DL SYMBOLS:** Sets the number of downlink symbols.

- Y **UL SYMBOLS:** Sets the number of uplink symbols.
- n **DELAY:** Sets the delay in micro seconds. This key is used only when there is a time offset in the signals to be measured.
- n **START SYMBOL:** Sets the start symbol.
- n **STOP SYMBOL:** Sets the stop symbol.

Setting Limit



This hot key is used to set the threshold value for the limit line on the display screen. It turns on or off the limit or band limit settings of the measurement for pass/fail indication. The user input window must be inactive first to get the Limit hot key function other than the number input.

| Step | Description |
|---|--|
| 1. Select the limit mode LIMIT [RF Test Limits] [Spectrum Emission Mask] [Test Limit] <On> or <Off> | Press the LIMIT hot key. Press the RF Test Limits soft key. Press the Spectrum Emission Mask soft key. Press the Test Limit soft key to toggle between On and Off and select one. |
| 2. Enable beep LIMIT [Beep] <On> or <Off> | Press the LIMIT hot key. Press the Beep soft key to toggle between On and Off and select one. This will make audible alarm if the measurement result goes beyond the limit. |

- n **TEST LIMIT:** Enables or disables Pass/Fail results on the display screen. Toggle the **Test Limit** soft key to set it to **On** or **Off**.

Measurement Example

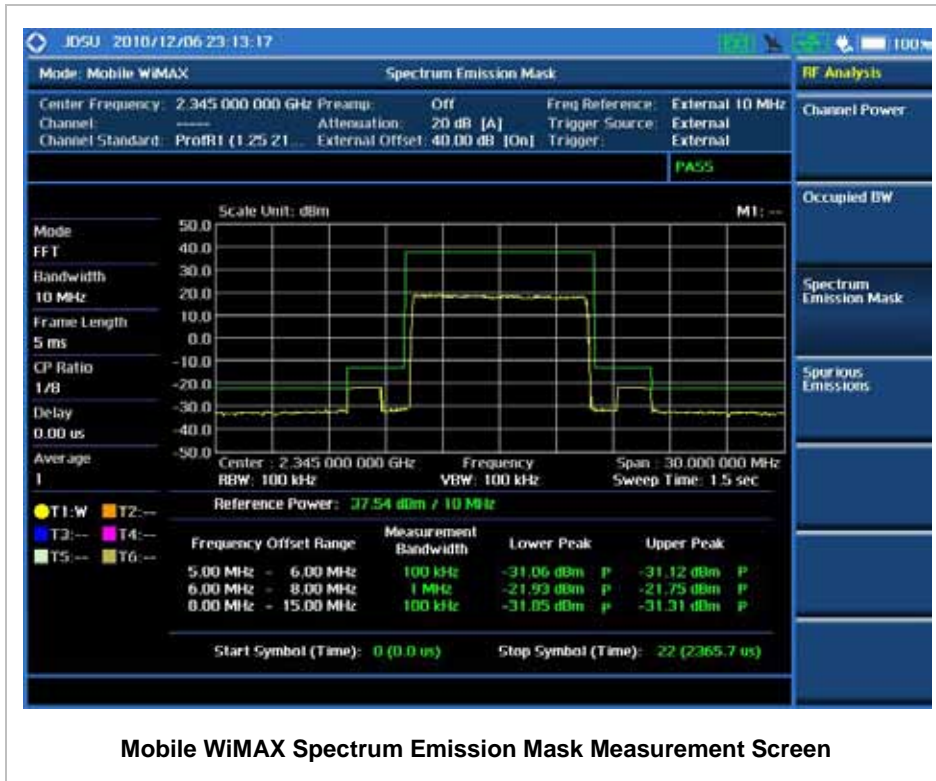

SPURIOUS EMISSIONS

Out-of-band emissions are unwanted emissions immediately outside the channel bandwidth resulting from the modulation process and non-linearity in the transmitter but excluding spurious emissions. The Spurious Emissions measurement is to identify and determine the power level of out-of-band spurious emission within the necessary channel bandwidth and modulated signal measured at the RF port of the Base Station.

Measurement Procedure

| Step | Description |
|--|--|
| 1. Set the measurement mode MEASURE [RF Analysis] [Spurious Emissions] | Press the MEASURE hot key. Press the RF Analysis soft key. Press the Spurious Emissions soft key. |
| 2. Set the measurement parameters MEASURE SETUP [Range Table] [Range] | Press the MEASURE SETUP hot key. Press the Range Table soft key. Press the Range soft key. |

| | |
|---|--|
| Enter a value [Enter] [Start Frequency] | Use the numeric keys to select the range number. Press the Enter soft key. Press the Start Frequency soft key. |
| Enter a value [GHz], [MHz], [kHz], or [Hz] [Stop Frequency] | Use the numeric keys. Press one of the unit soft keys to select. Press the Stop Frequency soft key. |
| Enter a value [GHz], [MHz], [kHz], or [Hz] [Start Limit] | Use the numeric keys. Press one of the unit soft keys to select. Press the Start Limit soft key. |
| Enter a value [dBm] [Stop Limit] | Use the numeric keys. Press the unit soft key to complete the input. Press the Stop Limit soft key. |
| Enter a value [dBm] [Attenuation] | Use the numeric keys. Press the unit soft key to complete the input. Press the Attenuation soft key. |
| Enter a value [dB] or ENTER [RBW] | Use the numeric keys to enter input value in the multiple of 5. Press the dB unit soft key or the ENTER hard key. Press the RBW soft key. |
| Enter a value [GHz], [MHz], [kHz], or [Hz] [VBW] | Use the numeric keys. Press one of the unit soft keys to select. Press the VBW soft key. |
| Enter a value [GHz], [MHz], [kHz], or [Hz] [Measure Type] | Use the numeric keys. Press one of the unit soft keys to select. Press the Measure Type soft key to toggle between Examine and Full . |
| <Examine> or <Full> [Average] | |
| Enter a value [Enter] or ENTER | Press the Average soft key. Use the numeric keys to enter a value. Press the Enter soft key or the ENTER hard key. |

Mobile WiMAX Spurious Emissions Measurement Procedure

MEASURE SETUP



Sets the measurement parameters including range table and measurement type. The measurement settings can be saved and recalled as a file. Also, JDViewer, PC application software allows the user to set the parameters in the user’s computer to import into the instrument.

- n **RANGE TABLE:** Sets the range table parameters.
- Y **RANGE:** Adds a new range number or selects one of the existing range numbers to show or hide the particular frequency range in the range table at the bottom of the screen. Use the numeric keys to enter a range number and press the **Enter** soft key to complete the input.

Each time the **Range** soft key is press, it toggles between **On** and **Off**.

- Y **START FREQUENCY:** Sets or changes the start frequency value to be measured for the selected range number in the Range menu. Use the numeric keys to enter a value and press one of the unit soft keys.
- Y **STOP FREQUENCY:** Sets or changes the stop frequency value to be measured for the selected range number in the Range menu. Use the numeric keys to enter a value and press one of the unit soft keys.
- Y **START LIMIT:** Sets the start value of the limit line for the displayed range.
- Y **STOP LIMIT:** Sets the stop value of the limit line for the displayed range.
- Y **ATTENUATION:** Sets the attenuation value in the multiple of 5.
- Y **RBW:** Sets the resolution bandwidth for the selected range number in the Range menu.
- Y **VBW:** Sets the video bandwidth for the selected range number in the Range menu.
- n **MEASURE TYPE:** Sets the measurement type to **Examine** or **Full**. Toggle between **Examine** and **Full**. Examine mode will show selected range only. The instrument will automatically switch and show all ranges when Full is selected.
- n **RANGE:** Selects the range number to be displayed on the screen. This key is activated only when the **Measure Type** is set to **Examine** mode. Use the numeric keys to select one of the existing range numbers that are configured in the Range Table menu. Pressing the **Enter** soft key completes the input and changes the display.
- n **AVERAGE:** Sets the frequency the number of trace to be averaged.

Setting Limit



This hot key is used to set the threshold value for the limit line on the display screen. It turns on or off the limit or band limit settings of the measurement for pass/fail indication. The user input window must be inactive first to get the Limit hot key function other than the number input.

| Step | Description |
|---|--|
| 1. Select the limit LIMIT [RF Test Limits] [Spurious Emissions] [Test Limit] <On> or <Off> | Press the LIMIT hot key. Press the RF Test Limits soft key. Press the Spurious Emissions soft key. Press the Test Limit soft key to toggle between On and Off and select one. |

| | |
|--|---|
| <p>2. Enable beep</p> <p>LIMIT</p> <p>[Beep]</p> <p><On> or <Off></p> | <p>Press the LIMIT hot key.</p> <p>Press the Beep soft key to toggle between On and Off and select one. This will make audible alarm if the measurement result goes beyond the limit.</p> |
|--|---|

- n **TEST LIMIT:** Enables or disables Pass/Fail results on the display screen. Toggle the **Test Limit** soft key to set it to **On** or **Off**.

Measurement Example

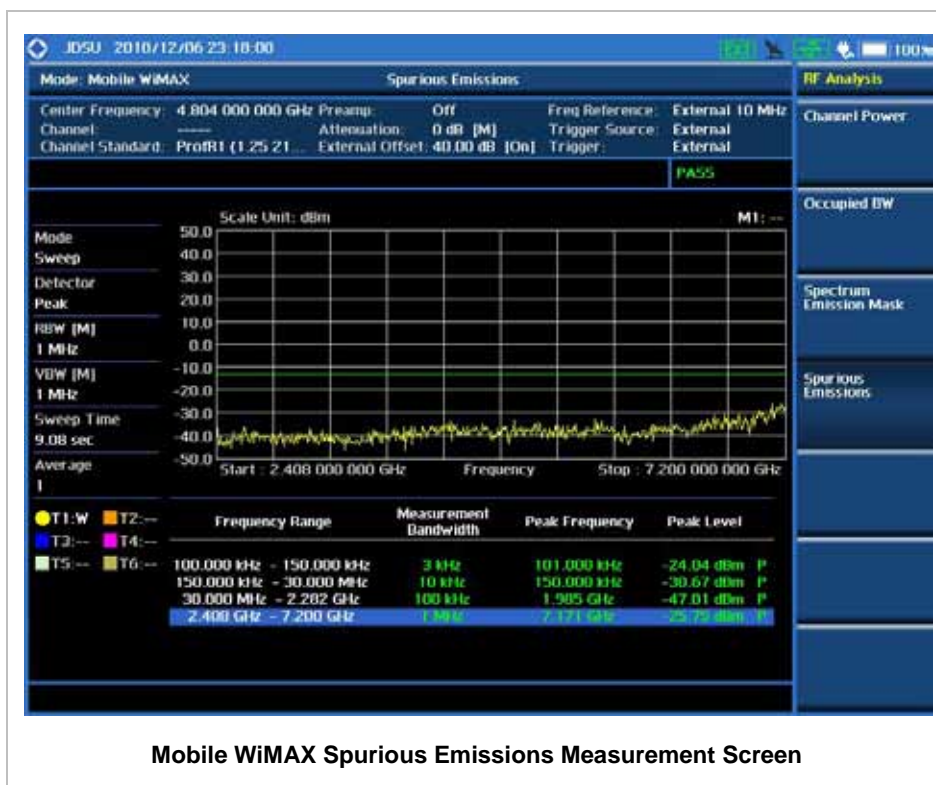

POWER VS TIME (FRAME) MEASUREMENT

The Power vs Time (Frame) in Mobile WiMAX Signal Analyzer measures the modulation envelope in the time domain, showing the power of each time slot in a Mobile WiMAX signal.

Setting Mode

| Step | Description |
|---|---|
| 1. Connect the cable | Connect a cable directly or indirectly as shown in the section Connecting a Cable on page 6 of this chapter. |
| 2. Select the mode MODE [Signal Analyzer] [More (1/2)] [Mobile WiMAX] [Power vs Time (Frame)] | Press the MODE hard key. Press the Signal Analyzer soft key. Press the More (1/2) soft key to get more soft keys. Press the Mobile WiMAX soft key. Press the Power vs Time (Frame) soft key. |

Setting Frequency

| Step | Description |
|---|--|
| 1. Set the frequency FREQ/DIST [Unit] <Freq> or <Channel> <i>When Freq is selected:</i> [Center Frequency] Enter a value [GHz], [MHz], [kHz], or [Hz] <i>When Channel is selected:</i> [Channel Standard] Select a channel standard [Select] or ENTER [Channel Number] Enter a value [Forward] | Press the FREQ/DIST hard key. Press the Unit soft key. Toggle this key between Freq and Channel . A set of Freq/Dist screen menu changes accordingly. Press the Center Frequency soft key. Use the numeric keys, the rotary knob, or the arrow keys. When using the numeric keys, the input is completed by selecting one of the unit soft keys. Press the Channel Standard soft key. Press the arrow keys, rotate the knob, or press the Page Up and Page Down soft keys to highlight a frequency band to select. Press the Select soft key or the ENTER hard key. Press the Channel Number soft key. Use the numeric keys to input value and press the Forward soft key to complete the input. The instrument automatically displays its corresponding center frequency value for the channel number. |

FREQ/DIST



n **UNIT:** Determines the way how to set the frequency band either with standard band or custom

frequency band. Toggling this key between **Freq** and **Channel** changes a set of Freq/Dist screen menu automatically.

- n **CENTER FREQUENCY:** Changes the center frequency setting. Use the rotary knob or the arrow keys. Or use the numeric keys to input a certain value and press one of the unit soft keys to complete the input.
- n **FREQUENCY STEP:** Defines the amount of frequency to be increased or decreased when using the rotary knob or the arrow keys to change the **Center Frequency**. This frequency step size can be entered by using numeric keys and the unit soft keys.
- n **CHANNEL NUMBER:** Enters a channel number. The instrument automatically displays its corresponding center frequency value for the channel number.
- n **CHANNEL STEP:** Defines the amount of channel to be increased or decreased when using the rotary knob or the arrow keys to change the **Channel Number**. This channel step size can be entered by using numeric keys and the **Enter** soft key.
- n **CHANNEL STANDARD:** When the channel standard is selected from the list, the center frequency information on the display screen will be mapped accordingly to the selected channel standard. The channel standards available in the instrument are listed in the Appendix C – Band, Frequency & Channel Standard.

Setting Amplitude

| Step | Description |
|---|---|
| 1. Set the reference/attenuation level AMP/SCALE [Auto Scale] | Press the AMP/SCALE hard key. Press the Auto Scale soft key to automatically set optimum levels of reference and attenuation. |
| or | |
| [Reference Level] Enter a reference level value | Press the Reference Level soft key to set manually. Use the numeric keys or the rotary knob that changes in a 10 dB step. |
| [dBm] or ENTER | Press the dBm soft key or the ENTER hard key. |
| [Attenuation] <Manual> Enter an attenuation value | Press the Attenuation soft key. The Auto mode is set by default. This key toggles between the Auto and Manual . Press the Attenuation soft key to highlight the Manual mode and change the attenuation value to optimize S/N. Use the numeric keys or the rotary knob that changes in a 5 dB step. The attenuation setting range is 0 to 50 dB. |

AMP/SCALE



- n **AUTO SCALE:** The instrument can automatically set the scale to the minimum and maximum values on the Y-axis of the graph for optimum display of the traces measured. Each time the **Auto Scale** is selected, the top and bottom scales are set to the minimum and maximum values with margin on the Y-axis of the display screen.
- n **REFERENCE LEVEL:** Sets the maximum Y-axis range.
- n **ATTENUATION**
 - Y **AUTO:** Input attenuator's value is automatically set depending on the reference level. This is the default operation mode, so it is recommended to use this mode unless a special measurement condition is needed.
 - Y **MANUAL:** Sets the attenuator's value for the **Spectrum Analyzer RF In 50 Ω** port.
- n **PREAMP:** Turns on or off the internal pre-amplifier. Preamp results in a correction being applied to compensate for the gain of the preamp so that amplitude readings show the value at the input connector. This soft key toggles between the **On** and **Off**. When it is set to On, the allowable attenuation input range is from 0 dB to 10 dB in a multiple of 5. If the attenuation value is manually set greater than 10 dB, the instrument will automatically turn off the pre-amplifier to display low level signal properly on the screen.
- n **EXTERNAL OFFSET:** Sets an external offset value. An offset consists of a cable loss and a user offset and the measurement result shows the value reflecting both offset values. When the external offset value is set at 40 dB in the Spectrum mode, the measurement result compensates 40 dB at both the Spectrum Analyzer and Signal Analyzer modes.

Setting Sweep Mode

SWEEP



This hot key is used to set the sweep parameters. The user input window must be inactive first to get the Sweep hot key function other than the number input.

- n **SWEEP MODE:** Sets the sweep method. Toggle between **Continue** and **Single**.

| Step | Description |
|--|---|
| 1. Set the sweep mode SWEEP [Sweep Mode] | Press the SWEEP hot key. Press the Sweep Mode soft key. Toggle between Continue and Single . |

Setting Trigger Source



This hot key is used to select the trigger source among **Internal**, **External**, and **GPS**. The user input window must be inactive first to get the Trigger hot key function other than the number input.

Setting External Clock

To enhance the reliability of modulation analysis measurements the JD740A series must be synchronized with the Base Station. When an external clock is not supplied, the JD740A series works with a built-in internal high-accuracy time base. In this case, some measurement results may exhibit inaccurate values. Therefore, it is highly recommended to use the same reference clock as signal source. Trigger mode can be changed by using the **TRIGGER** hot key.

EXTERNAL CLOCK OPERATING STANDARDS

| Clock | Type | Reference | Port | Switching Standard |
|--------------------|----------|--------------------|---------------|--|
| External Reference | Internal | Internal 10 MHz | | Default |
| | External | External Ref Clock | Ext Ref (SMA) | Manual switching (Input signal level >-3 dBm) |
| | GPS | GPS Clock | GPS (SMA) | Automatic switching (GPS signal received) |
| Trigger | Internal | Internal Trigger | | Default |
| | External | External Trigger | Trigger (SMA) | Manual switching |
| | GPS | GPS | GPS (SMA) | Manual switching |

CONNECTION

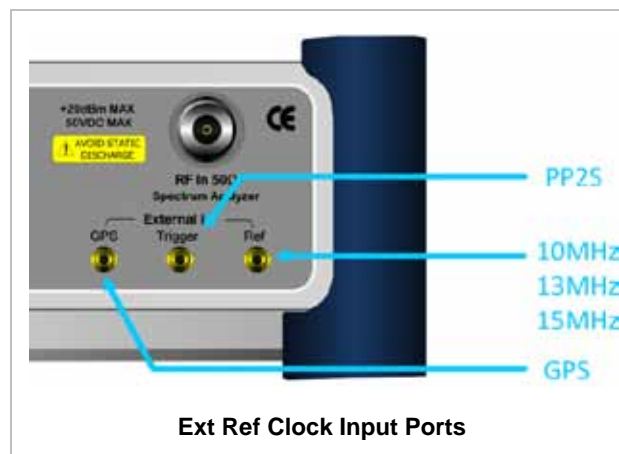

ENABLING EXTERNAL REFERENCE

| Step | Description |
|--|--|
| 1. Connect an external reference | Connect one of the external references or a GPS antenna to the JD740A series. |
| 2. Change reference clock SYSTEM [Frequency Reference] [External 10 MHz], [External 13 MHz], [External 15 MHz] or [GPS] | Press the SYSTEM hot key. Press the Frequency Reference soft key to select one of the external reference clocks or GPS. Press one of the soft keys to choose among External 10 MHz , External 13 MHz , External 15 MHz , and GPS . |

EXTERNAL REFERENCE INDICATOR INFORMATION

Each indicator tells different locking status according to a connection. When a GPS antenna is connected, longitude and latitude information will be displayed on the screen.

| Type | Indicator | Description |
|----------|--|----------------------------------|
| Internal |  (Green) | Locked |
| External |  (Green) | Locked |
| |  (Red) | Unlocked |
| GPS |  (Green) | Locked |
| |  (Yellow) | Locking in progress |
| |  (Gray) | Unable to lock or antenna failed |

Measurement Procedure

| Step | Description |
|---|--|
| 1. Set the measurement mode MEASURE [Power vs Time (Frame)] | Press the MEASURE hot key. Press the Power vs Time (Frame) soft key. |
| 2. Set the measurement parameters MEASURE SETUP [System Config] [Bandwidth] [7 MHz (8/7)], [8.75 MHz (8/7)], or | Press the MEASURE SETUP hot key. Press the System Config soft key. Press the Bandwidth soft key. Press one of the soft keys to select the bandwidth. |

| | |
|--|---|
| <p>[10 MHz (28/25)] [Frame Length] <5 ms> or <10 ms> [TTG (RTG)] Enter a value [uSec] [CP Ratio] <1/32>, <1/16>, <1/8>, or <1/4></p> | <p>Press the Frame Length soft key. Toggle between 5 ms and 10 ms to select one. Press the TTG (RTG) soft key. Use the numeric keys to input value. Press the unit soft key to complete the input. Press the CP Ratio soft key. Each time the soft key is pressed the selection moves.</p> |
| <p>[DL Symbols] Enter a value [Enter] [UL Symbols] Enter a value [Enter]</p> | <p>Press the DL Symbols soft key. Use the numeric keys to input value. Press the Enter soft key to complete the input. Press the UL Symbols soft key. Use the numeric keys to input value. Press the Enter soft key to complete the input.</p> |
| <p>[Start Symbol] Enter a value [Enter]</p> | <p>Press the Start Symbol soft key. Use the numeric keys to input value. Press the Enter soft key to complete the input.</p> |
| <p>[Stop Symbol] Enter a value [Enter]</p> | <p>Press the Stop Symbol soft key. Use the numeric keys to input value. Press the Enter soft key to complete the input.</p> |
| <p>[Preamble Index] <Auto> or <Manual></p> | <p>Press the Preamble Index soft key. Toggle between Auto and Manual to select one.</p> |
| <p>[Search Type] <Full> or <Window></p> | <p>Press the Search Type soft key. Toggle between Full and Window to select one.</p> |
| <p>[Video Filter] <On> or <Off></p> | <p>Press the Video Filter soft key. Toggle between On and Off.</p> |

Mobile WiMAX Power vs Time (Frame) Measurement Procedure

MEASURE SETUP



- n **SYSTEM CONFIG:** Sets the system configuration.
- Y **BANDWIDTH:** Selects the nominal channel bandwidths to be measured.
 - **7 MHz (8/7):** Sets the channel bandwidth to 7 MHz with sampling factor 8/7. In conjunction with nominal channel bandwidth.
 - **8.75 MHz (8/7):** Sets the channel bandwidth to 8.75 MHz with sampling factor 8/7.
 - **10 MHz (28/25):** Sets the channel bandwidth to 10 MHz with sampling factor 28/25.

- Y **FRAME LENGTH:** Sets the length of a frame. Toggle this soft key between **5 ms** and **10 ms**.
- Y **TTG (RTG):** Sets the transmit/receive transition gap between the last sample of the downlink (DL) burst and the first sample of the subsequent uplink (UL) burst.
- Y **CP RATIO:** Sets the Cyclic Prefix (CP) ratio among **1/4**, **1/8**, **1/16**, and **1/32**. Each time this soft key is pressed the selection moves. A copy of the last Tg of the useful symbol period, termed CP, is used to collect multipath, while maintaining the orthogonality of the tones.
- Y **DL SYMBOLS:** Sets the number of downlink symbols.
- Y **UL SYMBOLS:** Sets the number of uplink symbols.
- n **START SYMBOL:** Sets the start symbol.
- n **STOP SYMBOL:** Sets the stop symbol.
- n **PREAMBLE INDEX:** Selects the preamble search methods, **Auto** or **Manual**.
- n **VIDEO FILTER:** Turns the video filter mode on or off.
- n **MISCELLANEOUS**
 - Y **DETECT MODE:** Selects the modulation type to be detected among **Auto**, **QPSK**, **16QAM**, and **64QAM**. Each time this soft key is pressed, the selection moves.
 - Y **DELAY:** Sets the delay in micro seconds. This key is used only when there is a time offset in the signals to be measured.

Setting Limit



This hot key is used to set the threshold value for the limit line on the display screen. It turns on or off the limit or band limit settings of the measurement for pass/fail indication. The user input window must be inactive first to get the Limit hot key function other than the number input.

| Step | Description |
|--|---|
| 1. Select the limit LIMIT [PvsT Test Limits] [Preamble Power] [Test Limits] <On> or <Off> [High Limit] [Low Limit] | Press the LIMIT hot key. Press the PvsT Test Limits soft key. Press the Preamble Power soft key. Press the Test Limits soft key. Toggle between On and Off . Use the numeric keys and input a number in dBm. Use the numeric keys and input a number in dBm. |

| | |
|--|---|
| <p>[DL Burst Power] [Test Limits] <On> or <Off> [High Limit] [Low Limit]</p> <p>[Up Burst Power] [Test Limits] <On> or <Off> [High Limit] [Low Limit]</p> <p>[Frame Average Power] [Test Limits] <On> or <Off> [High Limit] [Low Limit]</p> <p>[Time Offset] [Test Limits] <On> or <Off> [High Limit] [Low Limit]</p> <p>[IQ Origin Offset] [Test Limit] <On> or <Off> [High Limit]</p> | <p>Press the DL Burst Power soft key. Press the Test Limits soft key. Toggle between On and Off. Use the numeric keys and input a number in dBm. Use the numeric keys and input a number in dBm.</p> <p>Press the Up Burst Power soft key. Press the Test Limits soft key. Toggle between On and Off. Use the numeric keys and input a number in dBm. Use the numeric keys and input a number in dBm.</p> <p>Press the Frame Average Power soft key. Press the Test Limits soft key. Toggle between On and Off. Use the numeric keys and input a number in dBm. Use the numeric keys and input a number in dBm.</p> <p>Press the Time Offset soft key. Press the Test Limit soft key. Toggle between On and Off. Use the numeric keys and input a number in us. Use the numeric keys and input a number in us.</p> <p>Press the IQ Origin Offset soft key. Press the Test Limit soft key. Toggle between On and Off. Use the numeric keys and input a number in dB.</p> |
| <p>2. Enable beep LIMIT [Beep] <On> or <Off></p> | <p>Press the LIMIT hot key. Press the Beep soft key to toggle between On and Off and select one. This will make audible alarm if the measurement result goes beyond the limit.</p> |

n **PREAMBLE POWER:** Sets the preamble power limits.

Y **TEST LIMITS:** Enables or disables the test limits. Toggle the **Test Limits** soft key between **On** and **Off**.

Y **HIGH LIMIT:** Sets the upper limit. Use the numeric keys to input value and press the unit soft key or the **ENTER** hard key to complete the input.

Y **LOW LIMIT:** Sets the lower limit. Use the numeric keys to input value and press the unit soft key or the **ENTER** hard key to complete the input.

- n **DL BURST POWER:** Sets the downlink burst power limits.
 - Y **TEST LIMITS:** Enables or disables the test limits. Toggle the **Test Limits** soft key between **On** and **Off**.
 - Y **HIGH LIMIT:** Sets the upper limit. Use the numeric keys to input value and press the unit soft key or the **ENTER** hard key to complete the input.
 - Y **LOW LIMIT:** Sets the lower limit. Use the numeric keys to input value and press the unit soft key or the **ENTER** hard key to complete the input.
- n **UP BURST POWER:** Sets the uplink burst power limits.
 - Y **TEST LIMITS:** Enables or disables the test limits. Toggle the **Test Limits** soft key between **On** and **Off**.
 - Y **HIGH LIMIT:** Sets the upper limit. Use the numeric keys to input value and press the unit soft key or the **ENTER** hard key to complete the input.
 - Y **LOW LIMIT:** Sets the lower limit. Use the numeric keys to input value and press the unit soft key or the **ENTER** hard key to complete the input.
- n **FRAME AVERAGE POWER:** Sets the frame average power limits.
 - Y **TEST LIMITS:** Enables or disables the test limits. Toggle the **Test Limits** soft key between **On** and **Off**.
 - Y **HIGH LIMIT:** Sets the upper limit. Use the numeric keys to input value and press the unit soft key or the **ENTER** hard key to complete the input.
 - Y **LOW LIMIT:** Sets the lower limit. Use the numeric keys to input value and press the unit soft key or the **ENTER** hard key to complete the input.
- n **TIME OFFSET:** Sets the offset time limits.
 - Y **TEST LIMITS:** Enables or disables the test limits. Toggle the **Test Limits** soft key between **On** and **Off**.
 - Y **HIGH LIMIT:** Sets the upper limit. Use the numeric keys to input value and press the unit soft key or the **ENTER** hard key to complete the input.
 - Y **LOW LIMIT:** Sets the lower limit. Use the numeric keys to input value and press the unit soft key or the **ENTER** hard key to complete the input.
- n **IQ ORIGIN OFFSET:** Sets the IQ origin offset limit.
 - Y **TEST LIMIT:** Enables or disables the test limit. Toggle the **Test Limit** soft key between **On** and **Off**.
 - Y **HIGH LIMIT:** Sets the upper limit. Use the numeric keys to input value and press the unit soft key or the **ENTER** hard key to complete the input.

Measurement Example

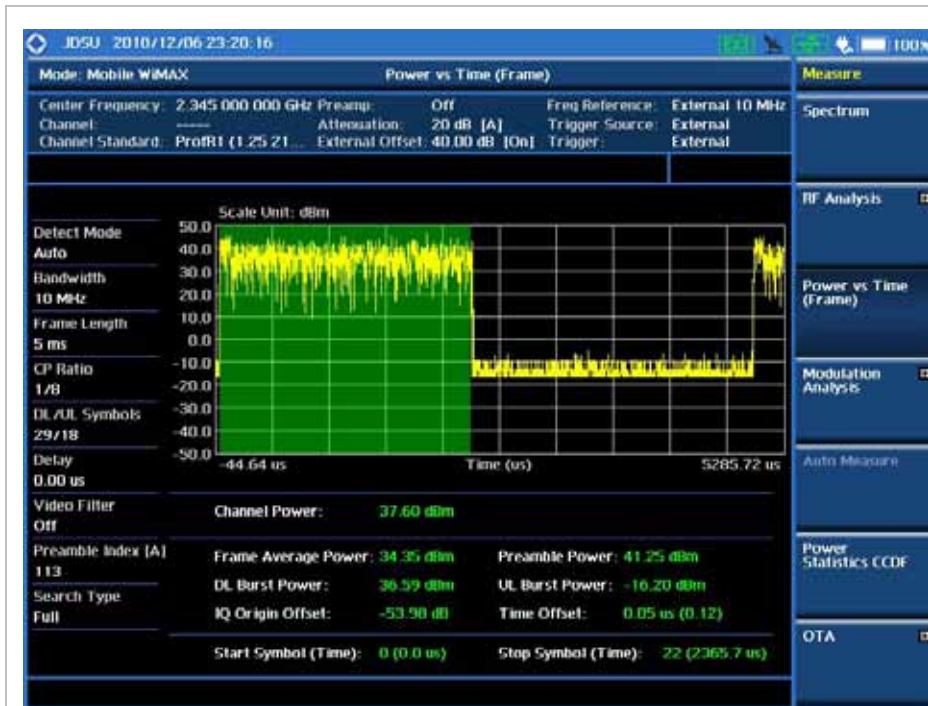

Mobile WiMAX Power vs Time (Frame) Measurement Screen

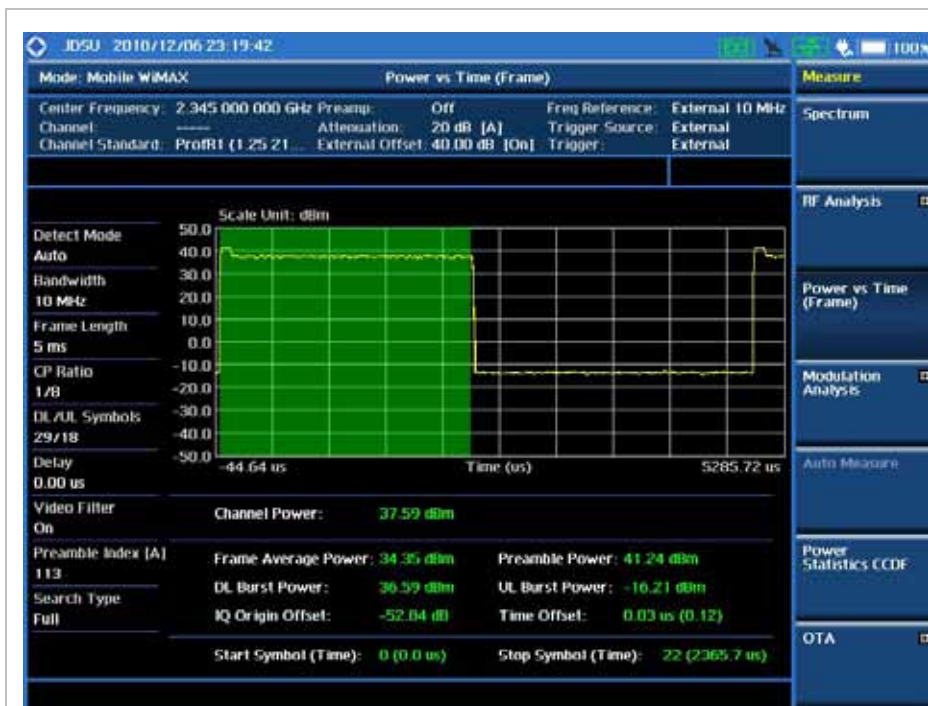

Mobile WiMAX Power vs Time (Frame) Measurement Screen (with Filter)

MODULATION ANALYSIS MEASUREMENTS

Modulation Analysis in Mobile WiMAX Signal Analyzer provides single-button measurements for the following essential measurements.

- n Constellation
- n Spectral Flatness
- n EVM vs Subcarrier
- n EVM vs Symbol

Setting Mode

| Step | Description |
|---|---|
| 1. Connect the cable | Connect a cable directly or indirectly as shown in the section Connecting a Cable on page 6 of this chapter. |
| 2. Select the mode MODE [Signal Analyzer] [More (1/2)] [Mobile WiMAX] [Modulation Analysis] [Constellation], [Spectral Flatness], [EVM vs Subcarrier], or [EVM vs Symbol] | Press the MODE hard key. Press the Signal Analyzer soft key. Press the More (1/2) soft key to get more soft keys. Press the Mobile WiMAX soft key. Press the Modulation Analysis soft key. Press one of the measurement mode soft keys to select. |

Setting Frequency

| Step | Description |
|---|--|
| 1. Set the frequency FREQ/DIST [Unit] <Freq> or <Channel> | Press the FREQ/DIST hard key. Press the Unit soft key. Toggle this key between Freq and Channel . A set of Freq/Dist screen menu changes accordingly. |
| <u>When Freq is selected:</u> [Center Frequency] | Press the Center Frequency soft key. |

| | |
|--|--|
| <p>Enter a value [GHz], [MHz], [kHz], or [Hz]</p> | <p>Use the numeric keys, the rotary knob, or the arrow keys. When using the numeric keys, the input is completed by selecting one of the unit soft keys.</p> |
| <p><i>When Channel is selected:</i> [Channel Standard] Select a channel standard</p> | <p>Press the Channel Standard soft key. Press the arrow keys, rotate the knob, or press the Page Up and Page Down soft keys to highlight a frequency band to select.</p> |
| <p>[Select] or ENTER</p> | <p>Press the Select soft key or the ENTER hard key.</p> |
| <p>[Channel Number] Enter a value [Forward]</p> | <p>Press the Channel Number soft key. Use the numeric keys to input value and press the Forward soft key to complete the input. The instrument automatically displays its corresponding center frequency value for the channel number.</p> |

FREQ/DIST

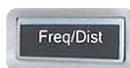

- n **UNIT:** Determines the way how to set the frequency band either with standard band or custom frequency band. Toggling this key between **Freq** and **Channel** changes a set of Freq/Dist screen menu automatically.
- n **CENTER FREQUENCY:** Changes the center frequency setting. Use the rotary knob or the arrow keys. Or use the numeric keys to input a certain value and press one of the unit soft keys to complete the input.
- n **FREQUENCY STEP:** Defines the amount of frequency to be increased or decreased when using the rotary knob or the arrow keys to change the **Center Frequency**. This frequency step size can be entered by using numeric keys and the unit soft keys.
- n **CHANNEL NUMBER:** Enters a channel number. The instrument automatically displays its corresponding center frequency value for the channel number.
- n **CHANNEL STEP:** Defines the amount of channel to be increased or decreased when using the rotary knob or the arrow keys to change the **Channel Number**. This channel step size can be entered by using numeric keys and the **Enter** soft key.
- n **CHANNEL STANDARD:** When the channel standard is selected from the list, the center frequency information on the display screen will be mapped accordingly to the selected channel standard. The channel standards available in the instrument are listed in the Appendix C – Band, Frequency & Channel Standard.

Setting Amplitude

| Step | Description |
|--|---|
| 1. Set the reference/attenuation level | |
| AMP/SCALE | Press the AMP/SCALE hard key. |
| [Auto Scale] | Press the Auto Scale soft key to automatically set optimum levels of reference and attenuation. |
| or | |
| [Reference Level] | Press the Reference Level soft key to set manually. |
| Enter a reference level value | Use the numeric keys or the rotary knob that changes in a 10 dB step. |
| [dBm] or ENTER | Press the dBm soft key or the ENTER hard key. |
| [Attenuation] | Press the Attenuation soft key. The Auto mode is set by default. This key toggles between the Auto and Manual . |
| <Manual> | Press the Attenuation soft key to highlight the Manual mode and change the attenuation value to optimize S/N. |
| Enter an attenuation value | Use the numeric keys or the rotary knob that changes in a 5 dB step. The attenuation setting range is 0 to 50 dB. |

AMP/SCALE



- n **AUTO SCALE:** The instrument can automatically set the scale to the minimum and maximum values on the Y-axis of the graph for optimum display of the traces measured. Each time the **Auto Scale** is selected, the top and bottom scales are set to the minimum and maximum values with margin on the Y-axis of the display screen.
- n **ATTENUATION**
 - Y **AUTO:** Input attenuator's value is automatically set depending on the reference level. This is the default operation mode, so it is recommended to use this mode unless a special measurement condition is needed.
 - Y **MANUAL:** Sets the attenuator's value for the **Spectrum Analyzer RF In 50 Ω** port.
- n **PREAMP:** Turns on or off the internal pre-amplifier. Preamp results in a correction being applied to compensate for the gain of the preamp so that amplitude readings show the value at the input connector. This soft key toggles between the **On** and **Off**. When it is set to On, the allowable attenuation input range is from 0 dB to 10 dB in a multiple of 5. If the attenuation value is manually set greater than 10 dB, the instrument will automatically turn off the pre-amplifier to display low level signal properly on the screen.
- n **EXTERNAL OFFSET:** Sets an external offset value. An offset consists of a cable loss and a user offset and the measurement result shows the value reflecting both offset values. When the

external offset value is set at 40 dB in the Spectrum mode, the measurement result compensates 40 dB at both the Spectrum Analyzer and Signal Analyzer modes.

Setting Sweep Mode



This hot key is used to set the sweep parameters. The user input window must be inactive first to get the Sweep hot key function other than the number input.

- n **SWEEP MODE:** Sets the sweep method. Toggle between **Continue** and **Single**.

| Step | Description |
|---|---|
| 1. Set the sweep mode SWEEP [Sweep Mode] | Press the SWEEP hot key. Press the Sweep Mode soft key. Toggle between Continue and Single . |

Setting Trigger Source



This hot key is used to select the trigger source among **Internal**, **External**, and **GPS**. The user input window must be inactive first to get the Trigger hot key function other than the number input.

Setting External Clock

To enhance the reliability of modulation analysis measurements the JD740A series must be synchronized with the Base Station. When an external clock is not supplied, the JD740A series works with a built-in internal high-accuracy time base. In this case, some measurement results may exhibit inaccurate values. Therefore, it is highly recommended to use the same reference clock as signal source. Trigger mode can be changed by using the **TRIGGER** hot key.

EXTERNAL CLOCK OPERATING STANDARDS

| Clock | Type | Reference | Port | Switching Standard |
|--------------------|----------|--------------------|---------------|--|
| External Reference | Internal | Internal 10 MHz | | Default |
| | External | External Ref Clock | Ext Ref (SMA) | Manual switching (Input signal level >-3 dBm) |
| | GPS | GPS Clock | GPS (SMA) | Automatic switching |

| | | | | |
|---------|----------|------------------|---------------|-----------------------|
| | | | | (GPS signal received) |
| Trigger | Internal | Internal Trigger | | Default |
| | External | External Trigger | Trigger (SMA) | Manual switching |
| | GPS | GPS | GPS (SMA) | Manual switching |

CONNECTION

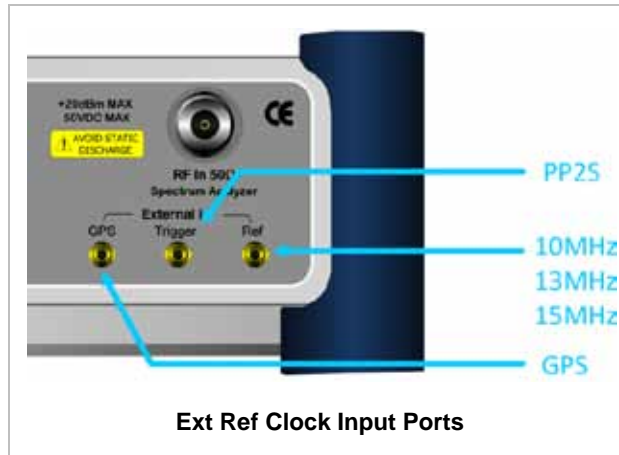







ENABLING EXTERNAL REFERENCE

| Step | Description |
|--|--|
| 1. Connect an external reference | Connect one of the external references or a GPS antenna to the JD740A series. |
| 2. Change reference clock SYSTEM [Frequency Reference] [External 10 MHz], [External 13 MHz], [External 15 MHz] or [GPS] | Press the SYSTEM hot key. Press the Frequency Reference soft key to select one of the external reference clocks or GPS. Press one of the soft keys to choose among External 10 MHz , External 13 MHz , External 15 MHz , and GPS . |

EXTERNAL REFERENCE INDICATOR INFORMATION

Each indicator tells different locking status according to a connection. When a GPS antenna is connected, longitude and latitude information will be displayed on the screen.

| Type | Indicator | Description |
|----------|---|-------------|
| Internal |  (Green) | Locked |

| | | |
|----------|--|----------------------------------|
| External |  (Green) | Locked |
| |  (Red) | Unlocked |
| GPS |  (Green) | Locked |
| |  (Yellow) | Locking in progress |
| |  (Gray) | Unable to lock or antenna failed |

CONSTELLATION

The Constellation is used to analyze transmitter modulation performance. The JD740A series displays the I-Q constellation diagram with modulation metrics to characterize the performance.

Measurement Procedure

| Step | Description |
|---|--|
| 1. Set the measurement mode MEASURE [Modulation Analysis] [Constellation] | Press the MEASURE hot key. Press the Modulation Analysis soft key. Press the Constellation soft key. |
| 2. Set the measurement parameters MEASURE SETUP [System Config] [Bandwidth] [7 MHz (8/7)], [8.75 MHz (8/7)], or [10 MHz (28/25)] [Frame Length] <5 ms> or <10 ms> [TTG (RTG)] Enter a value [uSec] [CP Ratio] <1/32>, <1/16>, <1/8>, or <1/4> [DL Symbols] Enter a value [Enter] [UL Symbols] Enter a value | Press the MEASURE SETUP hot key. Press the System Config soft key. Press the Bandwidth soft key. Press one of the soft keys to select the bandwidth. Press the Frame Length soft key. Toggle between 5 ms and 10 ms to select one. Press the TTG (RTG) soft key. Use the numeric keys to input value. Press the unit soft key to complete the input. Press the CP Ratio soft key. Each time the soft key is pressed the selection moves. Press the DL Symbols soft key. Use the numeric keys to input value. Press the Enter soft key to complete the input. Press the UL Symbols soft key. Use the numeric keys to input value. |

| | |
|---|---|
| [Enter] | Press the Enter soft key to complete the input. |
| [Start/Stop Symbol] Enter a value | Press the Start/Stop Symbol soft key. Use the numeric keys to input value. |
| [Enter] | Press the Enter soft key to complete the input. |
| [Preamble Index] <Auto> or <Manual> | Press the Preamble Index soft key. Toggle between Auto and Manual to select one. |
| [Search Type] <Full> or <Window> | Press the Search Type soft key. Toggle between Full and Window to select one. |

Mobile WiMAX Constellation Measurement Procedure

MEASURE SETUP



- n **SYSTEM CONFIG:** Sets the system configuration.
- Y **BANDWIDTH:** Selects the nominal channel bandwidths to be measured.
 - **7 MHz (8/7):** Sets the channel bandwidth to 7 MHz with sampling factor 8/7. In conjunction with nominal channel bandwidth.
 - **8.75 MHz (8/7):** Sets the channel bandwidth to 8.75 MHz with sampling factor 8/7.
 - **10 MHz (28/25):** Sets the channel bandwidth to 10 MHz with sampling factor 28/25.
- Y **FRAME LENGTH:** Sets the length of a frame. Toggle this soft key between **5 ms** and **10 ms**.
- Y **TTG (RTG):** Sets the transmit/receive transition gap between the last sample of the downlink (DL) burst and the first sample of the subsequent uplink (UL) burst.
- Y **CP RATIO:** Sets the Cyclic Prefix (CP) ratio among **1/4**, **1/8**, **1/16**, and **1/32**. Each time this soft key is pressed the selection moves. A copy of the last Tg of the useful symbol period, termed CP, is used to collect multipath, while maintaining the orthogonality of the tones.
- Y **DL SYMBOLS:** Sets the number of downlink symbols.
- Y **UL SYMBOLS:** Sets the number of uplink symbols.
- n **START/STOP SYMBOL:** Sets the start/stop symbol.
- n **PREAMBLE INDEX:** Selects the preamble search methods, **Auto** or **Manual**.
- n **SEARCH TYPE:** Selects the search type, **Full** or **Window**.
- n **MISCELLANEOUS**
 - Y **DETECT MODE:** Selects the modulation type to be detected among **Auto**, **QPSK**, **16QAM**, and **64QAM**. Each time this soft key is pressed, the selection moves.

- Y **DL ZONE:** Selects the Permutation Zone which is a number of contiguous OFDMA symbols in DL that use the same permutation. The DL subframe may contain more than one permutation zone. The maximum number of DL zones is 8 in one DL subframe.
- **AUTO:** Selects the permutation zone automatically.
 - **PUSC:** Selects the permutation zone to Partial Usage of Subcarrier Channels.
 - **FUSC:** Selects the permutation zone to Full Usage of Subcarrier Channels.
 - **AMC2X3:** Selects the permutation zone to Adaptive Modulation and Coding.
- Y **DELAY:** Sets the delay in micro seconds. This key is used only when there is a time offset in the signals to be measured.

Setting Limit



This hot key is used to set the threshold value for the limit line on the display screen. It turns on or off the limit or band limit settings of the measurement for pass/fail indication. The user input window must be inactive first to get the Limit hot key function other than the number input.

| Step | Description |
|----------------------------------|--|
| 1. Select the limit | |
| LIMIT | Press the LIMIT hot key. |
| [Modulation Test Limits] | Press the Modulation Test Limits soft key. |
| [Frequency Error] | Press the Frequency Error soft key. |
| [Test Limits] | Press the Test Limits soft key. Toggle between On and Off . |
| <On> or <Off> | |
| [High Limit] | Use the numeric keys and input a number in ppm. |
| [Low Limit] | Use the numeric keys and input a number in ppm. |
| [RCE RMS] | Press the RCE RMS soft key. |
| [Test Limits] | Press the Test Limits soft key. Toggle between On and Off . |
| <On> or <Off> | |
| [High Limit] | Use the numeric keys and input a number in dB. |
| [RCE Peak] | Press the RCE Peak soft key. |
| [Test Limits] | Press the Test Limits soft key. Toggle between On and Off . |
| <On> or <Off> | |
| [High Limit] | Use the numeric keys and input a number in dB. |
| [EVM RMS] | Press the EVM RMS soft key. |

| | |
|--|--|
| <p>[Test Limits] <On> or <Off> [High Limit]</p> <p>[EVM Peak] [Test Limits] <On> or <Off> [High Limit]</p> | <p>Press the Test Limits soft key. Toggle between On and Off.</p> <p>Use the numeric keys and input a number in %.</p> <p>Press the EVM Peak soft key.</p> <p>Press the Test Limits soft key. Toggle between On and Off.</p> <p>Use the numeric keys and input a number in %.</p> |
| <p>2. Enable beep LIMIT [Beep] <On> or <Off></p> | <p>Press the LIMIT hot key.</p> <p>Press the Beep soft key to toggle between On and Off and select one. This will make audible alarm if the measurement result goes beyond the limit.</p> |

- n **SPECTRAL FLATNESS:** *This key is not used in the Constellation mode.*
- n **FREQUENCY ERROR:** Sets the frequency error limits.
 - Y **TEST LIMITS:** Enables or disables the test limits. Toggle the **Test Limits** soft key between **On** and **Off**.
 - Y **HIGH LIMIT:** Sets the upper limit. Use the numeric keys to input value and press the unit soft key or the **ENTER** hard key to complete the input.
 - Y **LOW LIMIT:** Sets the lower limit. Use the numeric keys to input value and press the unit soft key or the **ENTER** hard key to complete the input.
- n **RCE RMS:** Sets the RCE RMS limits.
 - Y **TEST LIMITS:** Enables or disables the test limits. Toggle the **Test Limits** soft key between **On** and **Off**.
 - Y **HIGH LIMIT:** Sets the upper limit. Use the numeric keys to input value and press the unit soft key or the **ENTER** hard key to complete the input.
- n **RCE PEAK:** Sets the RCE Peak limits.
 - Y **TEST LIMITS:** Enables or disables the test limits. Toggle the **Test Limits** soft key between **On** and **Off**.
 - Y **HIGH LIMIT:** Sets the upper limit. Use the numeric keys to input value and press the unit soft key or the **ENTER** hard key to complete the input.
- n **EVM RMS:** Sets the EVM RMS limits.
 - Y **TEST LIMITS:** Enables or disables the test limits. Toggle the **Test Limits** soft key between **On** and **Off**.
 - Y **HIGH LIMIT:** Sets the upper limit. Use the numeric keys to input value and press the unit soft

key or the **ENTER** hard key to complete the input.

- n **EVM PEAK:** Sets the EVM Peak limit.
- Y **TEST LIMIT:** Enables or disables the test limit. Toggle the **Test Limit** soft key between **On** and **Off**.
- Y **HIGH LIMIT:** Sets the upper limit. Use the numeric keys to input value and press the unit soft key or the **ENTER** hard key to complete the input.

Measurement Example

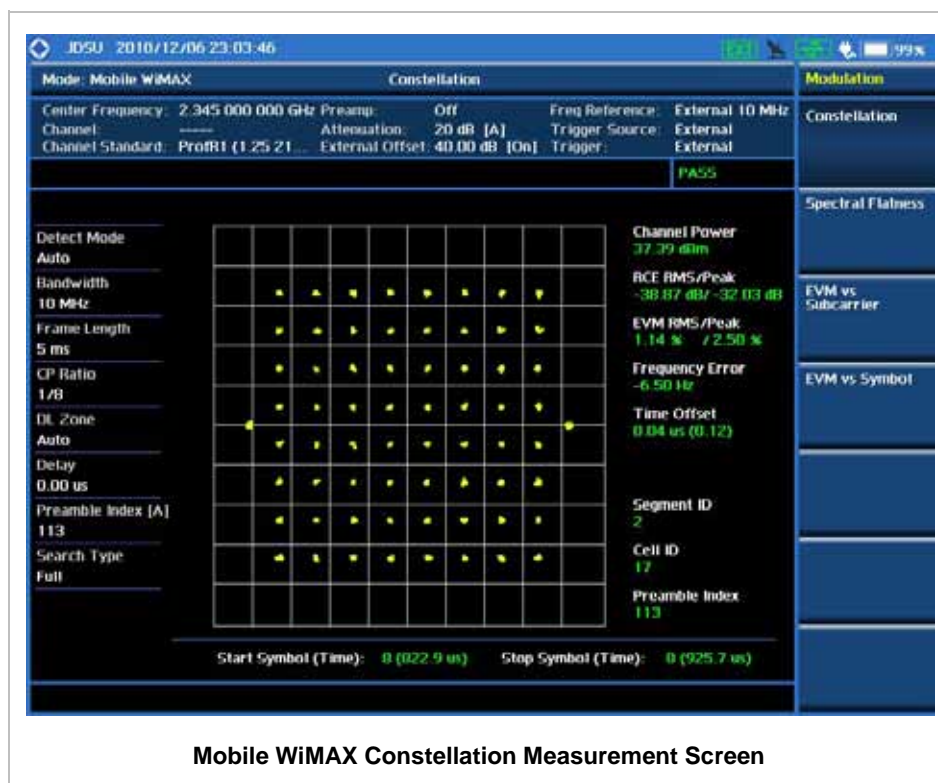

SPECTRAL FLATNESS

The Spectral Flatness is used to measure the flatness energy of the constellation according to the WiMAX specification IEEE 802.16e.

Measurement Procedure

| Step | Description |
|--|---|
| <p>1. Set the measurement mode</p> <p>MEASURE</p> <p>[Modulation Analysis]</p> <p>[Spectral Flatness]</p> | <p>Press the MEASURE hot key.</p> <p>Press the Modulation Analysis soft key.</p> <p>Press the Spectral Flatness soft key.</p> |
| <p>2. Set the measurement parameters</p> <p>MEASURE SETUP</p> <p>[System Config]</p> <p>[Bandwidth]</p> <p>[7 MHz (8/7)],</p> <p>[8.75 MHz (8/7)], or</p> <p>[10 MHz (28/25)]</p> <p>[Frame Length]</p> <p><5 ms> or <10 ms></p> <p>[TTG (RTG)]</p> <p>Enter a value</p> <p>[uSec]</p> <p>[CP Ratio]</p> <p><1/32>, <1/16>, <1/8>, or <1/4></p> <p>[DL Symbols]</p> <p>Enter a value</p> <p>[Enter]</p> <p>[UL Symbols]</p> <p>Enter a value</p> <p>[Enter]</p> <p>[Start Symbol]</p> <p>Enter a value</p> <p>[Enter]</p> <p>[Stop Symbol]</p> <p>Enter a value</p> <p>[Enter]</p> <p>[Preamble Index]</p> <p><Auto> or <Manual></p> <p>[Search Type]</p> <p><Full> or <Window></p> | <p>Press the MEASURE SETUP hot key.</p> <p>Press the System Config soft key.</p> <p>Press the Bandwidth soft key.</p> <p>Press one of the soft keys to select the bandwidth.</p> <p>Press the Frame Length soft key. Toggle between 5 ms and 10 ms to select one.</p> <p>Press the TTG (RTG) soft key.</p> <p>Use the numeric keys to input value.</p> <p>Press the unit soft key to complete the input.</p> <p>Press the CP Ratio soft key. Each time the soft key is pressed the selection moves.</p> <p>Press the DL Symbols soft key.</p> <p>Use the numeric keys to input value.</p> <p>Press the Enter soft key to complete the input.</p> <p>Press the UL Symbols soft key.</p> <p>Use the numeric keys to input value.</p> <p>Press the Enter soft key to complete the input.</p> <p>Press the Start Symbol soft key.</p> <p>Use the numeric keys to input value.</p> <p>Press the Enter soft key to complete the input.</p> <p>Press the Stop Symbol soft key.</p> <p>Use the numeric keys to input value.</p> <p>Press the Enter soft key to complete the input.</p> <p>Press the Preamble Index soft key. Toggle between Auto and Manual to select one.</p> <p>Press the Search Type soft key. Toggle between Full and Window to select one.</p> |

Mobile WiMAX Spectral Flatness Measurement Procedure

MEASURE SETUP



- n **SYSTEM CONFIG:** Sets the system configuration.
- Y **BANDWIDTH:** Selects the nominal channel bandwidths to be measured.
 - **7 MHz (8/7):** Sets the channel bandwidth to 7 MHz with sampling factor 8/7. In conjunction with nominal channel bandwidth.
 - **8.75 MHz (8/7):** Sets the channel bandwidth to 8.75 MHz with sampling factor 8/7.
 - **10 MHz (28/25):** Sets the channel bandwidth to 10 MHz with sampling factor 28/25.
- Y **FRAME LENGTH:** Sets the length of a frame. Toggle this soft key between **5 ms** and **10 ms**.
- Y **TTG (RTG):** Sets the transmit/receive transition gap between the last sample of the downlink (DL) burst and the first sample of the subsequent uplink (UL) burst.
- Y **CP RATIO:** Sets the Cyclic Prefix (CP) ratio among **1/4**, **1/8**, **1/16**, and **1/32**. Each time this soft key is pressed the selection moves. A copy of the last Tg of the useful symbol period, termed CP, is used to collect multipath, while maintaining the orthogonality of the tones.
- Y **DL SYMBOLS:** Sets the number of downlink symbols.
- Y **UL SYMBOLS:** Sets the number of uplink symbols.
- n **START SYMBOL:** Sets the start symbol.
- n **STOP SYMBOL:** Sets the stop symbol.
- n **PREAMBLE INDEX:** Selects the preamble search methods, **Auto** or **Manual**.
- n **SEARCH TYPE:** Selects the search type, **Full** or **Window**.
- n **MISCELLANEOUS**
 - Y **DETECT MODE:** Selects the modulation type to be detected among **Auto**, **QPSK**, **16QAM**, and **64QAM**. Each time this soft key is pressed, the selection moves.
 - Y **DL ZONE:** Selects the Permutation Zone which is a number of contiguous OFDMA symbols in DL that use the same permutation. The DL subframe may contain more than one permutation zone. The maximum number of DL zones is 8 in one DL subframe.
 - **AUTO:** Selects the permutation zone automatically.
 - **PUSC:** Selects the permutation zone to Partial Usage of Subcarrier Channels.
 - **FUSC:** Selects the permutation zone to Full Usage of Subcarrier Channels.
 - **AMC2X3:** Selects the permutation zone to Adaptive Modulation and Coding.
 - Y **DELAY:** Sets the delay in micro seconds. This key is used only when there is a time offset in the signals to be measured.

Setting Limit

LIMIT



This hot key is used to set the threshold value for the limit line on the display screen. It turns on or off the limit or band limit settings of the measurement for pass/fail indication. The user input window must be inactive first to get the Limit hot key function other than the number input.

| Step | Description |
|---|--|
| 1. Select the limit LIMIT [Modulation Test Limits] [Spectral Flatness] [Test Limits] <On> or <Off> | Press the LIMIT hot key. Press the Modulation Test Limits soft key. Press the Spectral Flatness soft key. Press the Test Limits soft key. Toggle between On and Off . |
| 2. Enable beep LIMIT [Beep] <On> or <Off> | Press the LIMIT hot key. Press the Beep soft key to toggle between On and Off and select one. |

- n **SPECTRAL FLATNESS:** Sets the spectral flatness limits.
- Y **TEST LIMITS:** Enables or disables the test limits. Toggle the this key between **On** and **Off**.
- n **FREQUENCY ERROR:** *This key is not used in the Spectral Flatness mode.*
- n **RCE RMS:** *This key is not used in the Spectral Flatness mode.*
- n **RCE PEAK:** *This key is not used in the Spectral Flatness mode.*
- n **EVM RMS:** *This key is not used in the Spectral Flatness mode.*
- n **EVM PEAK:** *This key is not used in the Spectral Flatness mode.*

Measurement Example



EVM VS SUBCARRIER

The EVM vs Subcarrier shows the error vector magnitude representing the average constellation error of WIMAX OFDMA subcarriers.

Measurement Procedure

| Step | Description |
|---|--|
| 1. Set the measurement mode MEASURE [Modulation Analysis] [EVM vs Subcarrier] | Press the MEASURE hot key. Press the Modulation Analysis soft key. Press the EVM vs Subcarrier soft key. |
| 2. Set the measurement parameters MEASURE SETUP [System Config] [Bandwidth] [7 MHz (8/7)], [8.75 MHz (8/7)], or [10 MHz (28/25)] | Press the MEASURE SETUP hot key. Press the System Config soft key. Press the Bandwidth soft key. Press one of the soft keys to select the bandwidth. |

| | |
|---|---|
| <p>[Frame Length] <5 ms> or <10 ms></p> <p>[TTG (RTG)] Enter a value</p> <p>[uSec]</p> <p>[CP Ratio] <1/32>, <1/16>, <1/8>, or <1/4></p> <p>[DL Symbols] Enter a value</p> <p>[Enter]</p> <p>[UL Symbols] Enter a value</p> <p>[Enter]</p> <p>[Start Symbol] Enter a value</p> <p>[Enter]</p> <p>[Stop Symbol] Enter a value</p> <p>[Enter]</p> <p>[Preamble Index] <Auto> or <Manual></p> <p>[Search Type] <Full> or <Window></p> | <p>Press the Frame Length soft key. Toggle between 5 ms and 10 ms to select one.</p> <p>Press the TTG (RTG) soft key. Use the numeric keys to input value. Press the unit soft key to complete the input.</p> <p>Press the CP Ratio soft key. Each time the soft key is pressed the selection moves.</p> <p>Press the DL Symbols soft key. Use the numeric keys to input value. Press the Enter soft key to complete the input.</p> <p>Press the UL Symbols soft key. Use the numeric keys to input value. Press the Enter soft key to complete the input.</p> <p>Press the Start Symbol soft key. Use the numeric keys to input value. Press the Enter soft key to complete the input.</p> <p>Press the Stop Symbol soft key. Use the numeric keys to input value. Press the Enter soft key to complete the input.</p> <p>Press the Preamble Index soft key. Toggle between Auto and Manual to select one.</p> <p>Press the Search Type soft key. Toggle between Full and Window to select one.</p> |
|---|---|

Mobile WiMAX EVM vs Subcarrier Measurement Procedure

MEASURE SETUP



- n **SYSTEM CONFIG:** Sets the system configuration.
- Y **BANDWIDTH:** Selects the nominal channel bandwidths to be measured.
 - **7 MHz (8/7):** Sets the channel bandwidth to 7 MHz with sampling factor 8/7. In conjunction with nominal channel bandwidth.
 - **8.75 MHz (8/7):** Sets the channel bandwidth to 8.75 MHz with sampling factor 8/7.
 - **10 MHz (28/25):** Sets the channel bandwidth to 10 MHz with sampling factor 28/25.
- Y **FRAME LENGTH:** Sets the length of a frame. Toggle this soft key between **5 ms** and **10 ms**.
- Y **TTG (RTG):** Sets the transmit/receive transition gap between the last sample of the downlink (DL) burst and the first sample of the subsequent uplink (UL) burst.

- Y **CP RATIO:** Sets the Cyclic Prefix (CP) ratio among **1/4**, **1/8**, **1/16**, and **1/32**. Each time this soft key is pressed the selection moves. A copy of the last Tg of the useful symbol period, termed CP, is used to collect multipath, while maintaining the orthogonality of the tones.
- Y **DL SYMBOLS:** Sets the number of downlink symbols.
- Y **UL SYMBOLS:** Sets the number of uplink symbols.
- n **START SYMBOL:** Sets the start symbol.
- n **STOP SYMBOL:** Sets the stop symbol.
- n **PREAMBLE INDEX:** Selects the preamble search methods, **Auto** or **Manual**.
- n **SEARCH TYPE:** Selects the search type, **Full** or **Window**.
- n **MISCELLANEOUS**
 - Y **DETECT MODE:** Selects the modulation type to be detected among **Auto**, **QPSK**, **16QAM**, and **64QAM**. Each time this soft key is pressed, the selection moves.
 - Y **DL ZONE:** Selects the Permutation Zone which is a number of contiguous OFDMA symbols in DL that use the same permutation. The DL subframe may contain more than one permutation zone. The maximum number of DL zones is 8 in one DL subframe.
 - **AUTO:** Selects the permutation zone automatically.
 - **PUSC:** Selects the permutation zone to Partial Usage of Subcarrier Channels.
 - **FUSC:** Selects the permutation zone to Full Usage of Subcarrier Channels.
 - **AMC2X3:** Selects the permutation zone to Adaptive Modulation and Coding.
 - Y **DELAY:** Sets the delay in micro seconds. This key is used only when there is a time offset in the signals to be measured.

Setting Limit



This hot key is used to set the threshold value for the limit line on the display screen. It turns on or off the limit or band limit settings of the measurement for pass/fail indication. The user input window must be inactive first to get the Limit hot key function other than the number input.

| Step | Description |
|--|--|
| 1. Select the limit LIMIT [Modulation Test Limits] | Press the LIMIT hot key. Press the Modulation Test Limits soft key. |

| | |
|---|---|
| <p>[RCE RMS] [Test Limits] <On> or <Off> [High Limit]</p> <p>[RCE Peak] [Test Limits] <On> or <Off> [High Limit]</p> <p>[EVM RMS] [Test Limits] <On> or <Off> [High Limit]</p> <p>[EVM Peak] [Test Limits] <On> or <Off> [High Limit]</p> | <p>Press the RCE RMS soft key. Press the Test Limits soft key. Toggle between On and Off. Use the numeric keys and input a number in dB.</p> <p>Press the RCE Peak soft key. Press the Test Limits soft key. Toggle between On and Off. Use the numeric keys and input a number in dB.</p> <p>Press the EVM RMS soft key. Press the Test Limits soft key. Toggle between On and Off. Use the numeric keys and input a number in %.</p> <p>Press the EVM Peak soft key. Press the Test Limits soft key. Toggle between On and Off. Use the numeric keys and input a number in %.</p> |
| <p>2. Enable beep LIMIT [Beep] <On> or <Off></p> | <p>Press the LIMIT hot key. Press the Beep soft key to toggle between On and Off and select one. This will make audible alarm if the measurement result goes beyond the limit.</p> |

- n **SPECTRAL FLATNESS:** *This key is not used in the EVM vs Subcarrier mode.*
- n **FREQUENCY ERROR:** *This key is not used in the EVM vs Subcarrier mode.*
- n **RCE RMS:** Sets the RCE RMS limits.
 - Y **TEST LIMITS:** Enables or disables the test limits. Toggle the **Test Limits** soft key between **On** and **Off**.
 - Y **HIGH LIMIT:** Sets the upper limit. Use the numeric keys to input value and press the unit soft key or the **ENTER** hard key to complete the input.
- n **RCE PEAK:** Sets the RCE Peak limits.
 - Y **TEST LIMITS:** Enables or disables the test limits. Toggle the **Test Limits** soft key between **On** and **Off**.
 - Y **HIGH LIMIT:** Sets the upper limit. Use the numeric keys to input value and press the unit soft key or the **ENTER** hard key to complete the input.
- n **EVM RMS:** Sets the EVM RMS limits.
 - Y **TEST LIMITS:** Enables or disables the test limits. Toggle the **Test Limits** soft key between

On and Off.

- Y **HIGH LIMIT:** Sets the upper limit. Use the numeric keys to input value and press the unit soft key or the **ENTER** hard key to complete the input.
- n **EVM PEAK:** Sets the EVM Peak limit.
- Y **TEST LIMIT:** Enables or disables the test limit. Toggle the **Test Limit** soft key between **On** and **Off**.
- Y **HIGH LIMIT:** Sets the upper limit. Use the numeric keys to input value and press the unit soft key or the **ENTER** hard key to complete the input.

Measurement Example

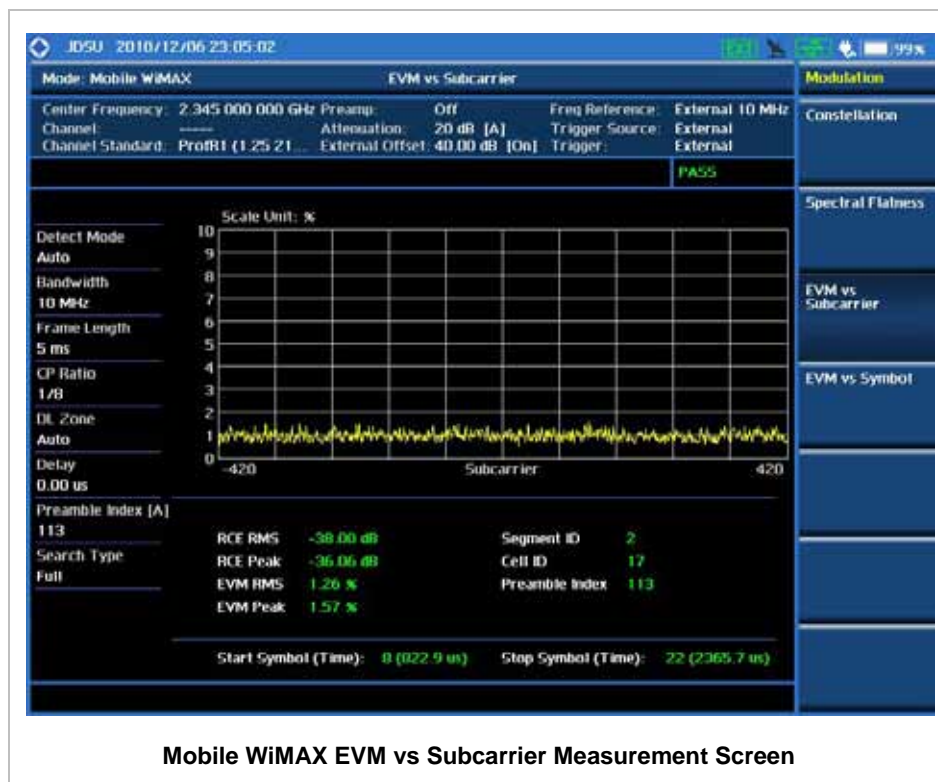

EVM vs SYMBOL

The EVM vs Symbol is used to show the error vector magnitude representing the average constellation error of WiMAX OFDMA symbols.

Measurement Procedure

| Step | Description |
|---|--|
| 1. Set the measurement mode MEASURE [Modulation Analysis] [EVM vs Symbol] | Press the MEASURE hot key. Press the Modulation Analysis soft key. Press the EVM vs Symbol soft key. |
| 2. Set the measurement parameters MEASURE SETUP [System Config] [Bandwidth] [7 MHz (8/7)], [8.75 MHz (8/7)], or [10 MHz (28/25)] [Frame Length] <5 ms> or <10 ms> [TTG (RTG)] Enter a value [uSec] [CP Ratio] <1/32> , <1/16> , <1/8> , or <1/4> [DL Symbols] Enter a value [Enter] [UL Symbols] Enter a value [Enter] [Start Symbol] Enter a value [Enter] [Stop Symbol] Enter a value [Enter] [Preamble Index] <Auto> or <Manual> [Search Type] <Full> or <Window> | Press the MEASURE SETUP hot key. Press the System Config soft key. Press the Bandwidth soft key. Press one of the soft keys to select the bandwidth. Press the Frame Length soft key. Toggle between 5 ms and 10 ms to select one. Press the TTG (RTG) soft key. Use the numeric keys to input value. Press the unit soft key to complete the input. Press the CP Ratio soft key. Each time the soft key is pressed the selection moves. Press the DL Symbols soft key. Use the numeric keys to input value. Press the Enter soft key to complete the input. Press the UL Symbols soft key. Use the numeric keys to input value. Press the Enter soft key to complete the input. Press the Start Symbol soft key. Use the numeric keys to input value. Press the Enter soft key to complete the input. Press the Stop Symbol soft key. Use the numeric keys to input value. Press the Enter soft key to complete the input. Press the Preamble Index soft key. Toggle between Auto and Manual to select one. Press the Search Type soft key. Toggle between Full and Window to select one. |

Mobile WiMAX EVM vs Symbol Measurement Procedure

MEASURE SETUP



- n **SYSTEM CONFIG:** Sets the system configuration.
- Y **BANDWIDTH:** Selects the nominal channel bandwidths to be measured.
 - **7 MHz (8/7):** Sets the channel bandwidth to 7 MHz with sampling factor 8/7. In conjunction with nominal channel bandwidth.
 - **8.75 MHz (8/7):** Sets the channel bandwidth to 8.75 MHz with sampling factor 8/7.
 - **10 MHz (28/25):** Sets the channel bandwidth to 10 MHz with sampling factor 28/25.
- Y **FRAME LENGTH:** Sets the length of a frame. Toggle this soft key between **5 ms** and **10 ms**.
- Y **TTG (RTG):** Sets the transmit/receive transition gap between the last sample of the downlink (DL) burst and the first sample of the subsequent uplink (UL) burst.
- Y **CP RATIO:** Sets the Cyclic Prefix (CP) ratio among **1/4**, **1/8**, **1/16**, and **1/32**. Each time this soft key is pressed the selection moves. A copy of the last Tg of the useful symbol period, termed CP, is used to collect multipath, while maintaining the orthogonality of the tones.
- Y **DL SYMBOLS:** Sets the number of downlink symbols.
- Y **UL SYMBOLS:** Sets the number of uplink symbols.
- n **START SYMBOL:** Sets the start symbol.
- n **STOP SYMBOL:** Sets the stop symbol.
- n **PREAMBLE INDEX:** Selects the preamble search methods, **Auto** or **Manual**.
- n **SEARCH TYPE:** Selects the search type, **Full** or **Window**.
- n **MISCELLANEOUS**
 - Y **DETECT MODE:** Selects the modulation type to be detected among **Auto**, **QPSK**, **16QAM**, and **64QAM**. Each time this soft key is pressed, the selection moves.
 - Y **DL ZONE:** Selects the Permutation Zone which is a number of contiguous OFDMA symbols in DL that use the same permutation. The DL subframe may contain more than one permutation zone. The maximum number of DL zones is 8 in one DL subframe.
 - **AUTO:** Selects the permutation zone automatically.
 - **PUSC:** Selects the permutation zone to Partial Usage of Subcarrier Channels.
 - **FUSC:** Selects the permutation zone to Full Usage of Subcarrier Channels.
 - **AMC2X3:** Selects the permutation zone to Adaptive Modulation and Coding.
 - Y **DELAY:** Sets the delay in micro seconds. This key is used only when there is a time offset in the signals to be measured.

Setting Limit

LIMIT



This hot key is used to set the threshold value for the limit line on the display screen. It turns on or off the limit or band limit settings of the measurement for pass/fail indication. The user input window must be inactive first to get the Limit hot key function other than the number input.

| Step | Description |
|--|--|
| <p>1. Select the limit</p> <p>LIMIT</p> <p>[Modulation Test Limits]</p> <p>[RCE RMS]</p> <p>[Test Limits]</p> <p><On> or <Off></p> <p>[High Limit]</p> <p>[RCE Peak]</p> <p>[Test Limits]</p> <p><On> or <Off></p> <p>[High Limit]</p> <p>[EVM RMS]</p> <p>[Test Limits]</p> <p><On> or <Off></p> <p>[High Limit]</p> <p>[EVM Peak]</p> <p>[Test Limits]</p> <p><On> or <Off></p> <p>[High Limit]</p> | <p>Press the LIMIT hot key.</p> <p>Press the Modulation Test Limits soft key.</p> <p>Press the RCE RMS soft key.</p> <p>Press the Test Limits soft key. Toggle between On and Off.</p> <p>Use the numeric keys and input a number in dB.</p> <p>Press the RCE Peak soft key.</p> <p>Press the Test Limits soft key. Toggle between On and Off.</p> <p>Use the numeric keys and input a number in dB.</p> <p>Press the EVM RMS soft key.</p> <p>Press the Test Limits soft key. Toggle between On and Off.</p> <p>Use the numeric keys and input a number in %.</p> <p>Press the EVM Peak soft key.</p> <p>Press the Test Limits soft key. Toggle between On and Off.</p> <p>Use the numeric keys and input a number in %.</p> |
| <p>2. Enable beep</p> <p>LIMIT</p> <p>[Beep]</p> <p><On> or <Off></p> | <p>Press the LIMIT hot key.</p> <p>Press the Beep soft key to toggle between On and Off and select one. This will make audible alarm if the measurement result goes beyond the limit.</p> |

n **SPECTRAL FLATNESS:** *This key is not used in the EVM vs Symbol mode.*

n **FREQUENCY ERROR:** *This key is not used in the EVM vs Symbol mode.*

n **RCE RMS:** Sets the RCE RMS limits.

Y **TEST LIMITS:** Enables or disables the test limits. Toggle the **Test Limits** soft key between **On** and **Off**.

Y **HIGH LIMIT:** Sets the upper limit. Use the numeric keys to input value and press the unit soft

key or the **ENTER** hard key to complete the input.

- n **RCE PEAK:** Sets the RCE Peak limits.
 - Y **TEST LIMITS:** Enables or disables the test limits. Toggle the **Test Limits** soft key between **On** and **Off**.
 - Y **HIGH LIMIT:** Sets the upper limit. Use the numeric keys to input value and press the unit soft key or the **ENTER** hard key to complete the input.
- n **EVM RMS:** Sets the EVM RMS limits.
 - Y **TEST LIMITS:** Enables or disables the test limits. Toggle the **Test Limits** soft key between **On** and **Off**.
 - Y **HIGH LIMIT:** Sets the upper limit. Use the numeric keys to input value and press the unit soft key or the **ENTER** hard key to complete the input.
- n **EVM PEAK:** Sets the EVM Peak limit.
 - Y **TEST LIMIT:** Enables or disables the test limit. Toggle the **Test Limit** soft key between **On** and **Off**.
 - Y **HIGH LIMIT:** Sets the upper limit. Use the numeric keys to input value and press the unit soft key or the **ENTER** hard key to complete the input.

Measurement Example

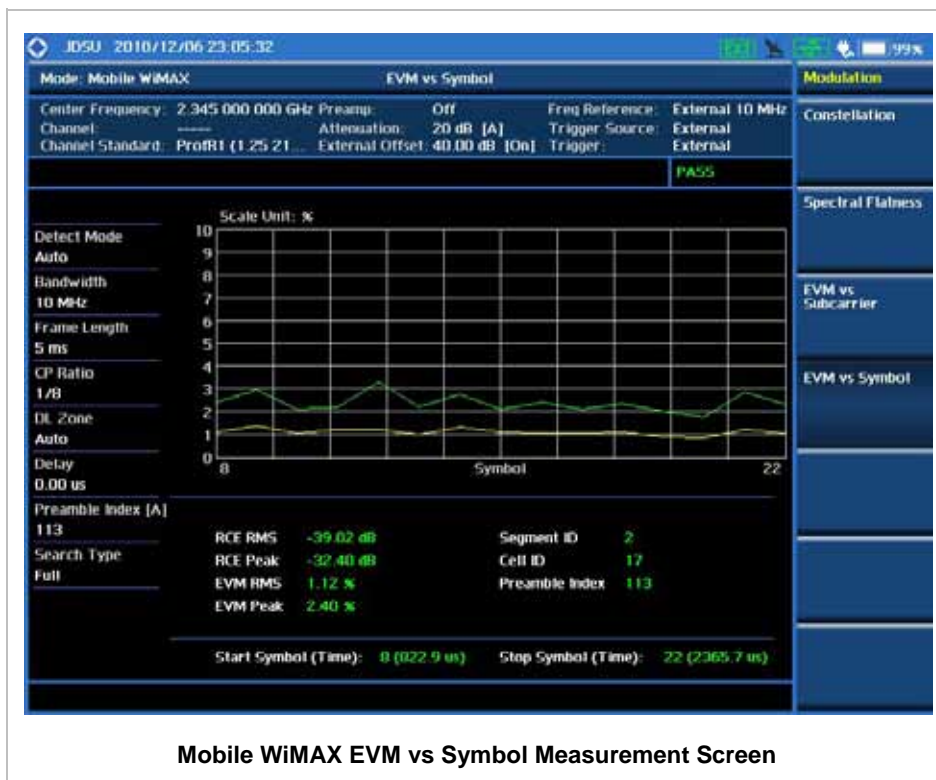

Mobile WiMAX EVM vs Symbol Measurement Screen

AUTO MEASUREMENT

The Auto Measure function of the JD740A series allows a complete signal profiling covering RF characterization and modulation quality parameters of up to 10 different carriers, particularly useful on an overlay architecture where base stations are transmitting in different frequencies.

The Auto Measure can be easily executed either by selecting a menu in the instrument or by running a programmed scenario in the PC-based application so that the instrument automatically configure and perform tests on every aspect of all the carriers.

Setting Mode

| Step | Description |
|--|--|
| 1. Connect the cable | Connect a cable directly or indirectly as shown in the section Connecting a Cable on page 6 of this chapter. |
| 2. Select the mode MODE [Signal Analyzer] [More (1/2)] [Mobile WiMAX] [Auto Measure] | Press the MODE hard key. Press the Signal Analyzer soft key. Press the More (1/2) soft key to get more soft keys. Press the Mobile WiMAX soft key. Press the Auto Measure soft key. |

Following settings are required only when you run Auto Measure on the instrument using “Current” configuration setting. Additional settings are not required when you run Auto Measure using a scenario generated in the PC application software, JDViewer.

Setting Frequency

| Step | Description |
|---|--|
| 1. Set the frequency FREQ/DIST [Unit] <Freq> or <Channel> | Press the FREQ/DIST hard key. Press the Unit soft key. Toggle this key between Freq and Channel . A set of Freq/Dist screen menu changes accordingly. |

| | |
|--|--|
| <p><u>When Freq is selected:</u></p> <p>[Center Frequency] Enter a value [GHz], [MHz], [kHz], or [Hz]</p> | <p>Press the Center Frequency soft key. Use the numeric keys, the rotary knob, or the arrow keys. When using the numeric keys, the input is completed by selecting one of the unit soft keys.</p> |
| <p><u>When Channel is selected:</u></p> <p>[Channel Standard] Select a channel standard</p> <p>[Select] or ENTER</p> | <p>Press the Channel Standard soft key. Press the arrow keys, rotate the knob, or press the Page Up and Page Down soft keys to highlight a frequency band to select. Press the Select soft key or the ENTER hard key.</p> |
| <p>[Channel Number] Enter a value [Forward]</p> | <p>Press the Channel Number soft key. Use the numeric keys to input value and press the Forward soft key to complete the input. The instrument automatically displays its corresponding center frequency value for the channel number.</p> |

FREQ/DIST

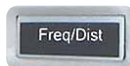

- n **UNIT:** Determines the way how to set the frequency band either with standard band or custom frequency band. Toggling this key between **Freq** and **Channel** changes a set of Freq/Dist screen menu automatically.
- n **CENTER FREQUENCY:** Changes the center frequency setting. Use the rotary knob or the arrow keys. Or use the numeric keys to input a certain value and press one of the unit soft keys to complete the input.
- n **FREQUENCY STEP:** Defines the amount of frequency to be increased or decreased when using the rotary knob or the arrow keys to change the **Center Frequency**. This frequency step size can be entered by using numeric keys and the unit soft keys.
- n **CHANNEL NUMBER:** Enters a channel number. The instrument automatically displays its corresponding center frequency value for the channel number.
- n **CHANNEL STEP:** Defines the amount of channel to be increased or decreased when using the rotary knob or the arrow keys to change the **Channel Number**. This channel step size can be entered by using numeric keys and the **Enter** soft key.
- n **CHANNEL STANDARD:** When the channel standard is selected from the list, the center frequency information on the display screen will be mapped accordingly to the selected channel standard. The channel standards available in the instrument are listed in the Appendix C – Band, Frequency & Channel Standard.

Setting Limit



This hot key is used to set the threshold value for the limit line on the display screen. It turns on or off the limit or band limit settings of the measurement for pass/fail indication. The user input window must be inactive first to get the Limit hot key function other than the number input.

| Step | Description |
|---|---|
| <p>1. Set the RF test limit</p> <p>LIMIT</p> <p>[RF Test Limits]</p> <p>[Channel Power]</p> <p>[Test Limits]</p> <p><On> or <Off></p> <p>[High Limit]</p> <p>Enter a value</p> <p>[dBm] or ENTER</p> <p>[Low Limit]</p> <p>Enter a value</p> <p>[dBm] or ENTER</p> <p>[Occupied BW]</p> <p>[Test Limit]</p> <p><On> or <Off></p> <p>[High Limit]</p> <p>Enter a value</p> <p>[MHz], [kHz], or [Hz]</p> <p>[Spectrum Emission Mask]</p> <p>[Test Limit]</p> <p><On> or <Off></p> <p>[Spurious Emissions]</p> <p>[Test Limit]</p> <p><On> or <Off></p> | <p>Press the LIMIT hot key.</p> <p>Press the RF Test Limits soft key.</p> <p>Press the Channel Power soft key.</p> <p>Press the Test Limits soft key to toggle between On and Off and select one.</p> <p>Press the High Limit soft key to set the upper limit of the Pass/Fail criteria. Use the numeric keys to input value.</p> <p>Press the unit soft key or the ENTER hard key.</p> <p>Press the Low Limit soft key to set the lower limit of the Pass/Fail criteria. Use the numeric keys to input value.</p> <p>Press the unit soft key or the ENTER hard key.</p> <p>Press the Occupied BW soft key.</p> <p>Press the Test Limit soft key to toggle between On and Off and select one.</p> <p>Press the High Limit soft key to set the upper limit of the Pass/Fail criteria. Use the numeric keys to input value.</p> <p>Press the unit soft key to select.</p> <p>Press the Spectrum Emission Mask soft key.</p> <p>Press the Test Limit soft key to toggle between On and Off and select one.</p> <p>Press the Spurious Emissions soft key.</p> <p>Press the Test Limit soft key to toggle between On and Off and select one.</p> |
| <p>2. Enable beep</p> <p>LIMIT</p> <p>[Beep]</p> <p><On> or <Off></p> | <p>Press the LIMIT hot key.</p> <p>Press the Beep soft key to toggle between On and Off and select one. This will make audible alarm if the measurement result goes beyond the limit.</p> |

- n **CHANNEL POWER:** Sets the test limit parameters.
 - Y **TEST LIMITS:** Enables or disables Pass/Fail results on the display screen. Toggle the **Test Limits** soft key to set it to **On** or **Off**.
 - Y **HIGH LIMIT:** Sets the upper limit of the Pass/Fail criteria. Use the numeric keys to enter a threshold or limit value and press the **dBm** unit soft key or the **ENTER** hard key to complete the input.
 - Y **LOW LIMIT:** Sets the lower limit of the Pass/Fail criteria. Use the numeric keys to enter a threshold or limit value and press the **dBm** unit soft key or the **ENTER** hard key to complete the input.
- n **OCCUPIED BW:** Sets the test limit parameters.
 - Y **TEST LIMIT:** Enables or disables Pass/Fail results on the display screen. Toggle the **Test Limit** soft key to set it to **On** or **Off**.
 - Y **HIGH LIMIT:** Sets the upper limit of the Pass/Fail criteria. Use the numeric keys to enter a threshold or limit value and press one of the unit soft keys to complete the input.
- n **SPECTRUM EMISSION MASK:** Sets the test limit parameter.
 - Y **TEST LIMIT:** Enables or disables Pass/Fail results on the display screen. Toggle the **Test Limit** soft key to set it to **On** or **Off**.
- n **SPURIOUS EMISSIONS:** Sets the test limit parameter.
 - Y **TEST LIMIT:** Enables or disables Pass/Fail results on the display screen. Toggle the **Test Limit** soft key to set it to **On** or **Off**.

Measurement Procedure

| Step | Description |
|--|--|
| 1. Select the mode MEASURE [Auto Measure] | Press the MEASURE hot key. Press the Auto Measure soft key. |
| 2. Set the measurement parameters MEASURE SETUP [Configuration] <Current> or <Scenario> [Load Scenario] | Press the MEASURE SETUP hot key. Press the Configuration soft key to select the mode. Toggle this soft key between Current and Scenario . Press the Load Scenario soft key to load a scenario file. This key is active only when the Configuration is set to Scenario . |

| | |
|---|--|
| <p>[Test Time] <Now> or <Schedule></p> | <p>Press the Test Time soft key to select when to run a test. Toggle this soft key between Now and Schedule.</p> |
| <p>[Set Timing]</p> <p>[Start Time (HH:MM)] Enter a value [HHMM]</p> <p>[Stop Time (HH:MM)] Enter a value [HHMM]</p> <p>[Time Interval] Enter a value [Min]</p> | <p>Press the Set Timing soft key. This key is activated only when the Test Time is set to Schedule.</p> <p>Press the Start Time soft key. Use the numeric keys to input value in HH:MM format. Press the HHMM soft key to complete the input.</p> <p>Press the Stop Time soft key. Use the numeric keys to input value in HH:MM format. Press the HHMM soft key to complete the input.</p> <p>Press the Time Interval soft key. Use the numeric keys to input value in minutes. Press the Min soft key to complete the input.</p> |
| <p>[Save Result] [File Name]</p> <p>[Save to] <Internal> or <USB></p> <p>[Save Screen] <All> or <Fail></p> | <p>Press the Save Result soft key.</p> <p>Press the File Name soft key to assign a specific name to the test result.</p> <p>Press the Save to soft key to select where to save the test result. Toggle this soft key between Internal and USB.</p> <p>Press the Save Screen soft key to choose the save option. Toggle this soft key between All and Fail. This key is activated only when the Save to is set to USB.</p> |
| <p>[Settings]</p> <p>[Start Symbol] Enter a value [Enter] or ENTER</p> <p>[Stop Symbol] Enter a value [Enter] or ENTER</p> <p>[Preamble Index] <Auto> or <Manual> Enter a value [Enter]</p> | <p>Press the Settings soft key.</p> <p>Press the Start Symbol soft key. Use the numeric keys to input value. Press the Enter soft key or the ENTER hard key.</p> <p>Press the Stop Symbol soft key. Use the numeric keys to input value. Press the Enter soft key or the ENTER hard key.</p> <p>Press the Preamble Index soft key. Toggle this soft key between Auto and Manual. Use the numeric keys to input value. Press the Enter soft key.</p> |
| <p>[Run Test]</p> | <p>Press the Run Test soft key to run a test.</p> |

Mobile WiMAX Auto Measurement Procedure

MEASURE SETUP



n **RUN TEST:** Starts a test.

- n **CONFIGURATION:** Selects the measurement configuration to be used. When the **Current** is selected, the instrument runs a test using current carrier frequency (single carrier) and determines pass/fail based on the instrument's limit settings. Select the **Scenario** to run a test with a programmed scenario.
- n **LOAD SCENARIO:** Selects and loads a scenario file generated by the PC application software, JDViewer. This soft key is activated only when the **Configuration** is set to **Scenario**.
- n **TEST TIME:** Selects the test time. When **Now** is selected, the instrument runs a test only once. When **Schedule** is selected, the instrument repeats tests as defined in the **Set Timing** menu.
- n **SET TIMING:** Sets the **Start Time**, **Stop Time**, and **Time Interval** of a scheduled measurement. This soft key is activated only when the **Test Time** is set to **Schedule**.
- n **SAVE RESULT:** Sets parameters for saving measurement results. The instrument automatically saves measurement results in *.CSV format as well so that they can be imported in an application software that supports the CSV format.
 - Y **FILE NAME:** Sets the measurement result file name.
 - Y **SAVE TO:** Sets the destination where the result to be saved, **Internal** or **USB**.
 - Y **SAVE SCREEN:** Selects what results to be saved into a USB drive. Toggle this soft key between All for all the measurement items and Fail for failed items only. This key is activated only when the **Save to** is set to **USB**.
- n **SETTINGS:** Sets the start and stop symbols and preamble index.
 - Y **START SYMBOL:** Sets the start symbol.
 - Y **STOP SYMBOL:** Sets the stop symbol.
 - Y **PREAMBLE INDEX:** Selects the preamble search methods, **Auto** or **Manual**.
 - Y **EXTERNAL OFFSET:** Sets an external offset value. An offset consists of a cable loss and a user offset and the measurement result shows the value reflecting both offset values. When the external offset value is set at 40 dB in the Spectrum mode, the measurement result compensates 40 dB at both the Spectrum Analyzer and Signal Analyzer modes.

Setting Display

TRACE/DISPLAY



- n **DISPLAY:** Changes the display option. After running automatic measurement, toggle this key between **Results** and **Settings**.
 - Y **RESULTS:** Shows actual measurement results on the display screen.
 - Y **SETTINGS:** Shows measurement parameters set for the automatic measurement.

- n **DISPLAY RESULTS:** Changes the display format of measurement results. This key becomes activated when the **Results** is set as the display option. Toggle this key between **Full** and **Quick** to check measurement results in different format.
 - Y **FULL:** Shows detailed measurement results, including actual measurement readings with pass/fail color indication.
 - Y **QUICK:** Shows quick view of pass/fail results.
- n **VIEW CARRIER:** Selects a carrier to be displayed among up to 10 carriers. This key becomes activated when the **Results** is set as the display option.

POWER STATISTICS CCDF

Power Statistics Complementary Cumulative Distribution Function (CCDF) measurement characterizes the power statistics of input signal. It provides PAR (Peak to Average power Ratio) versus different probabilities.

Setting Mode

| Step | Description |
|---|---|
| 1. Connect the cable | Connect a cable directly or indirectly as shown in the section Connecting a Cable on page 6 of this chapter. |
| 2. Select the mode MODE [Signal Analyzer] [More (1/2)] [Mobile WiMAX] [Power Statistics CCDF] | Press the MODE hard key. Press the Signal Analyzer soft key. Press the More (1/2) soft key to get more soft keys. Press the Mobile WiMAX soft key. Press the Power Statistics CCDF soft key. |

Setting Frequency

| Step | Description |
|---|--|
| 1. Set the frequency FREQ/DIST [Unit] <Freq> or <Channel> | Press the FREQ/DIST hard key. Press the Unit soft key. Toggle this key between Freq and Channel . A set of Freq/Dist screen menu changes accordingly. |

| | |
|--|--|
| <p><u>When Freq is selected:</u></p> <p>[Center Frequency] Enter a value [GHz], [MHz], [kHz], or [Hz]</p> | <p>Press the Center Frequency soft key. Use the numeric keys, the rotary knob, or the arrow keys. When using the numeric keys, the input is completed by selecting one of the unit soft keys.</p> |
| <p><u>When Channel is selected:</u></p> <p>[Channel Standard] Select a channel standard</p> <p>[Select] or ENTER</p> | <p>Press the Channel Standard soft key. Press the arrow keys, rotate the knob, or press the Page Up and Page Down soft keys to highlight a frequency band to select. Press the Select soft key or the ENTER hard key.</p> |
| <p>[Channel Number] Enter a value [Forward]</p> | <p>Press the Channel Number soft key. Use the numeric keys to input value and press the Forward soft key to complete the input. The instrument automatically displays its corresponding center frequency value for the channel number.</p> |

FREQ/DIST



- n **UNIT:** Determines the way how to set the frequency band either with standard band or custom frequency band. Toggling this key between **Freq** and **Channel** changes a set of Freq/Dist screen menu automatically.
- n **CENTER FREQUENCY:** Changes the center frequency setting. Use the rotary knob or the arrow keys. Or use the numeric keys to input a certain value and press one of the unit soft keys to complete the input.
- n **FREQUENCY STEP:** Defines the amount of frequency to be increased or decreased when using the rotary knob or the arrow keys to change the **Center Frequency**. This frequency step size can be entered by using numeric keys and the unit soft keys.
- n **CHANNEL NUMBER:** Enters a channel number. The instrument automatically displays its corresponding center frequency value for the channel number.
- n **CHANNEL STEP:** Defines the amount of channel to be increased or decreased when using the rotary knob or the arrow keys to change the **Channel Number**. This channel step size can be entered by using numeric keys and the **Enter** soft key.
- n **CHANNEL STANDARD:** When the channel standard is selected from the list, the center frequency information on the display screen will be mapped accordingly to the selected channel standard. The channel standards available in the instrument are listed in the Appendix C – Band,

Frequency & Channel Standard.

Setting Amplitude

| Step | Description |
|--|---|
| 1. Set the reference/attenuation level AMP/SCALE [Auto Scale] or [Attenuation] <Manual> Enter an attenuation value | Press the AMP/SCALE hard key. Press the Auto Scale soft key to automatically set optimum levels of reference and attenuation. Press the Attenuation soft key. The Auto mode is set by default. This key toggles between the Auto and Manual . Press the Attenuation soft key to highlight the Manual mode and change the attenuation value to optimize S/N. Use the numeric keys or the rotary knob that changes in a 5 dB step. The attenuation setting range is 0 to 50 dB. |

AMP/SCALE



- n **AUTO SCALE:** The instrument can automatically set the scale to the minimum and maximum values on the Y-axis of the graph for optimum display of the traces measured. Each time the **Auto Scale** is selected, the top and bottom scales are set to the minimum and maximum values with margin on the Y-axis of the display screen.
- n **ATTENUATION**
 - Y **AUTO:** Input attenuator's value is automatically set depending on the reference level. This is the default operation mode, so it is recommended to use this mode unless a special measurement condition is needed.
 - Y **MANUAL:** Sets the attenuator's value for the **Spectrum Analyzer RF In 50 Ω** port.

Setting Sweep Mode

SWEEP



This hot key is used to set the sweep parameters. The user input window must be inactive first to get the Sweep hot key function other than the number input.

- n **SWEEP MODE:** Sets the sweep method. Toggle between **Continue** and **Single**.

| Step | Description |
|---|---|
| 1. Set the sweep mode SWEEP [Sweep Mode] | Press the SWEEP hot key. Press the Sweep Mode soft key. Toggle between Continue and Single . |

Setting Trigger Source



This hot key is used to select the trigger source among **Internal**, **External**, and **GPS**. The user input window must be inactive first to get the Trigger hot key function other than the number input.

Setting External Clock

To enhance the reliability of modulation analysis measurements the JD740A series must be synchronized with the Base Station. When an external clock is not supplied, the JD740A series works with a built-in internal high-accuracy time base. In this case, some measurement results may exhibit inaccurate values. Therefore, it is highly recommended to use the same reference clock as signal source. Trigger mode can be changed by using the **TRIGGER** hot key.

EXTERNAL CLOCK OPERATING STANDARDS

| Clock | Type | Reference | Port | Switching Standard |
|--------------------|----------|--------------------|---------------|--|
| External Reference | Internal | Internal 10 MHz | | Default |
| | External | External Ref Clock | Ext Ref (SMA) | Manual switching (Input signal level >-3 dBm) |
| | GPS | GPS Clock | GPS (SMA) | Automatic switching (GPS signal received) |
| Trigger | Internal | Internal Trigger | | Default |
| | External | External Trigger | Trigger (SMA) | Manual switching |
| | GPS | GPS | GPS (SMA) | Manual switching |

CONNECTION

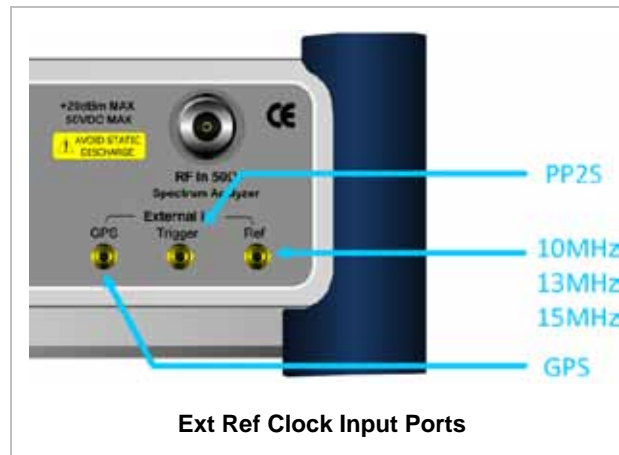

ENABLING EXTERNAL REFERENCE

| Step | Description |
|---|--|
| 1. Connect an external reference | Connect one of the external references or a GPS antenna to the JD740A series. |
| 2. Change reference clock SYSTEM [Frequency Reference] [External 10 MHz], [External 13 MHz], [External 15 MHz] or [GPS] | Press the SYSTEM hot key. Press the Frequency Reference soft key to select one of the external reference clocks or GPS. Press one of the soft keys to choose among External 10 MHz , External 13 MHz , External 15 MHz , and GPS . |

EXTERNAL REFERENCE INDICATOR INFORMATION

Each indicator tells different locking status according to a connection. When a GPS antenna is connected, longitude and latitude information will be displayed on the screen.

| Type | Indicator | Description |
|----------|-----------|----------------------------------|
| Internal | (Green) | Locked |
| External | (Green) | Locked |
| | (Red) | Unlocked |
| GPS | (Green) | Locked |
| | (Yellow) | Locking in progress |
| | (Gray) | Unable to lock or antenna failed |

Measurement Procedure

| Step | Description |
|--|---|
| 1. Set the measurement parameters MEASURE SETUP [CCDF Length] Enter a value [Enter] | Press the MEASURE SETUP hot key. Press the CCDF Length soft key. Use the numeric keys to input value. Press the Enter soft key. |

Mobile WiMAX Power Statistics CCDF Measurement Procedure

MEASURE SETUP 

- n **CCDF LENGTH:** Sets the length of the CCDF which is the number of measurements to be averaged. To change the value, use the numeric keys and press the **Enter** soft key or the **ENTER** hard key to complete to the input (value range 1 to 100).

Measurement Example



Mobile WiMAX Power Statistics CCDF Analysis Screen

MOBILE WiMAX OTA MEASUREMENTS

This Over The Air (OTA) measurement has preamble scanner, multipath profile, and preamble power trend screens. Preamble scanner displays six preambles and relative powers to inform neighbor cells existence. The multipath profile graph helps the user to determine testing area's RF environmental condition. The preamble power trend shows power variations of selected preamble over time along with relative power trend for strongest preamble.

Mobile WiMAX OTA Measurements provide the following essential measurements.

- n Preamble Scanner
- n Multipath Profile
- n Preamble Power Trend
- n Route Map

Setting Mode

Connecting a GPS antenna with the instrument is a mandatory for the OTA measurements.

| Step | Description |
|--|---|
| 1. Connect the antenna | Connect antennas as shown in the Connecting a Cable on page 7 of this chapter. |
| 2. Select the mode MODE [Signal Analyzer] [More (1/2)] [Mobile WiMAX] [OTA] [Preamble Scanner], [Multipath Profile], or [Preamble Power Trend], or [Route Map] | Press the MODE hard key. Press the Signal Analyzer soft key. Press the More (1/2) soft key to get more soft keys. Press the Mobile WiMAX soft key. Press the OTA soft key. Press one of the measurement mode soft keys to select. |

Setting Frequency

| Step | Description |
|---|--|
| 1. Set the frequency FREQ/DIST [Unit] <Freq> or <Channel> | Press the FREQ/DIST hard key. Press the Unit soft key. Toggle this key between Freq and Channel . A set of Freq/Dist screen menu changes accordingly. |

| | |
|--|--|
| <p><u>When Freq is selected:</u></p> <p>[Center Frequency] Enter a value [GHz], [MHz], [kHz], or [Hz]</p> <p><u>When Channel is selected:</u></p> <p>[Channel Standard] Select a channel standard</p> <p>[Select] or ENTER</p> <p>[Channel Number] Enter a value [Forward]</p> | <p>Press the Center Frequency soft key. Use the numeric keys, the rotary knob, or the arrow keys. When using the numeric keys, the input is completed by selecting one of the unit soft keys.</p> <p>Press the Channel Standard soft key. Press the arrow keys, rotate the knob, or press the Page Up and Page Down soft keys to highlight a frequency band to select. Press the Select soft key or the ENTER hard key.</p> <p>Press the Channel Number soft key. Use the numeric keys to input value and press the Forward soft key to complete the input. The instrument automatically displays its corresponding center frequency value for the channel number.</p> |
|--|--|

FREQ/DIST



- n **UNIT:** Determines the way how to set the frequency band either with standard band or custom frequency band. Toggling this key between **Freq** and **Channel** changes a set of Freq/Dist screen menu automatically.
- n **CENTER FREQUENCY:** Changes the center frequency setting. Use the rotary knob or the arrow keys. Or use the numeric keys to input a certain value and press one of the unit soft keys to complete the input.
- n **FREQUENCY STEP:** Defines the amount of frequency to be increased or decreased when using the rotary knob or the arrow keys to change the **Center Frequency**. This frequency step size can be entered by using numeric keys and the unit soft keys.
- n **CHANNEL NUMBER:** Enters a channel number. The instrument automatically displays its corresponding center frequency value for the channel number.
- n **CHANNEL STEP:** Defines the amount of channel to be increased or decreased when using the rotary knob or the arrow keys to change the **Channel Number**. This channel step size can be entered by using numeric keys and the **Enter** soft key.
- n **CHANNEL STANDARD:** When the channel standard is selected from the list, the center frequency information on the display screen will be mapped accordingly to the selected channel standard. The channel standards available in the instrument are listed in the Appendix C – Band,

Frequency & Channel Standard.

Setting Amplitude

| Step | Description |
|---|---|
| 1. Set the reference/attenuation level AMP/SCALE [Auto Scale] or [Reference Level] Enter a reference level value [dBm] or ENTER [Attenuation] <Manual> Enter an attenuation value | Press the AMP/SCALE hard key. Press the Auto Scale soft key to automatically set optimum levels of reference and attenuation. Press the Reference Level soft key to set manually. Use the numeric keys or the rotary knob that changes in a 10 dB step. Press the dBm soft key or the ENTER hard key. Press the Attenuation soft key. The Auto mode is set by default. This key toggles between the Auto and Manual . Press the Attenuation soft key to highlight the Manual mode and change the attenuation value to optimize S/N. Use the numeric keys or the rotary knob that changes in a 5 dB step. The attenuation setting range is 0 to 50 dB. |

AMP/SCALE



- n **AUTO SCALE:** The instrument can automatically set the scale to the minimum and maximum values on the Y-axis of the graph for optimum display of the traces measured. Each time the **Auto Scale** is selected, the top and bottom scales are set to the minimum and maximum values with margin on the Y-axis of the display screen.
- n **REFERENCE LEVEL:** Sets the maximum Y-axis range. *This key is used in the OTA Preamble Power Trend mode and the Route Map mode.*
- n **ATTENUATION**
 - Y **AUTO:** Input attenuator's value is automatically set depending on the reference level. This is the default operation mode, so it is recommended to use this mode unless a special measurement condition is needed.
 - Y **MANUAL:** Sets the attenuator's value for the **Spectrum Analyzer RF In 50 Ω** port.
- n **PREAMP:** Turns on or off the internal pre-amplifier. Preamp results in a correction being applied to compensate for the gain of the preamp so that amplitude readings show the value at the input connector. This soft key toggles between the **On** and **Off**. When it is set to On, the allowable attenuation input range is from 0 dB to 10 dB in a multiple of 5. If the attenuation value is manually

set greater than 10 dB, the instrument will automatically turn off the pre-amplifier to display low level signal properly on the screen.

- n **EXTERNAL OFFSET:** Sets an external offset value. An offset consists of a cable loss and a user offset and the measurement result shows the value reflecting both offset values. When the external offset value is set at 40 dB in the Spectrum mode, the measurement result compensates 40 dB at both the Spectrum Analyzer and Signal Analyzer modes.

Setting Sweep Mode



This hot key is used to set the sweep parameters. The user input window must be inactive first to get the Sweep hot key function other than the number input.

- n **SWEEP MODE:** Sets the sweep method. Toggle between **Continue** and **Single**.

| Step | Description |
|--|---|
| 1. Set the sweep mode SWEEP [Sweep Mode] | Press the SWEEP hot key. Press the Sweep Mode soft key. Toggle between Continue and Single . |

Setting Trigger Source



This hot key is used to select the trigger source among **Internal**, **External**, and **GPS**. The user input window must be inactive first to get the Trigger hot key function other than the number input. For OTA measurement, a GPS antenna should be connected and the trigger source should be set to **GPS**.

Setting External Clock

To enhance the reliability of modulation analysis measurements the JD740A series must be synchronized with the Base Station. When an external clock is not supplied, the JD740A series works with a built-in internal high-accuracy time base. In this case, some measurement results may exhibit inaccurate values. Therefore, it is highly recommended to use the same reference clock as signal source. Trigger mode can be changed by using the **TRIGGER** hot key.

EXTERNAL CLOCK OPERATING STANDARDS

| Clock | Type | Reference | Port | Switching Standard |
|--------------------|----------|--------------------|---------------|--|
| External Reference | Internal | Internal 10 MHz | | Default |
| | External | External Ref Clock | Ext Ref (SMA) | Manual switching (Input signal level >-3 dBm) |
| | GPS | GPS Clock | GPS (SMA) | Automatic switching (GPS signal received) |
| Trigger | Internal | Internal Trigger | | Default |
| | External | External Trigger | Trigger (SMA) | Manual switching |
| | GPS | GPS | GPS (SMA) | Manual switching |

CONNECTION

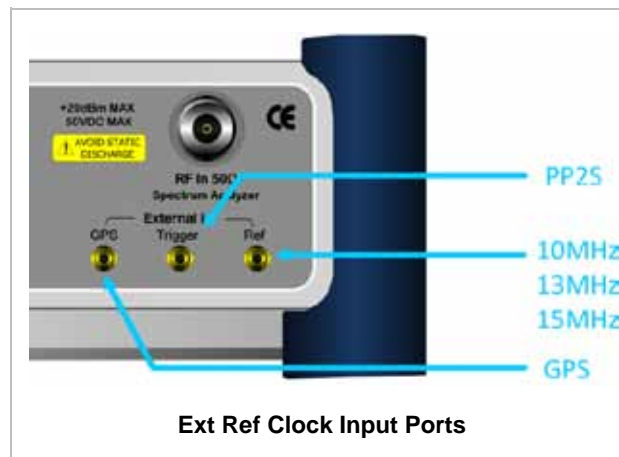



ENABLING GPS EXTERNAL REFERENCE

| Step | Description |
|--|--|
| 1. Connect a GPS antenna | Connect a GPS antenna to the JD740A series. |
| 2. Change reference clock SYSTEM [Frequency Reference] [GPS] | Press the SYSTEM hot key. Press the Frequency Reference soft key. Press the GPS soft key to perform OTA measurements. |

GPS EXTERNAL REFERENCE INDICATOR INFORMATION

When a GPS antenna is connected, the instrument automatically detects it. Each indicator tells different locking status depending on its connection. If it is successfully locked, the instrument will display "GPS" and longitude and latitude information on the screen. If it is unlocked or the antenna is disconnected, the display will be automatically switched to "Internal".

| Type | Indicator | Description |
|------|--|----------------------------------|
| GPS |  (Green) | Locked |
| |  (Yellow) | Locking in progress |
| |  (Gray) | Unable to lock or antenna failed |

MOBILE WIMAX OTA PREAMBLE SCANNER

The OTA Preamble Scanner displays the six strongest preambles to inform neighbor cells existence of testing area. Preamble Index, Relative Power, Cell ID, and Sector ID are listed in for each preamble signal with Time Offset in us. Positioning information, latitude and longitude will be displayed if a GPS antenna is supplied and locked to the GPS satellites on the bottom of the screen.

Measurement Procedure

| Step | Description |
|---|--|
| 1. Set the measurement mode MEASURE [OTA] [Preamble Scanner] | Press the MEASURE hot key. Press the OTA soft key. Press the Preamble Scanner soft key. |
| 2. Set the measurement parameters MEASURE SETUP [System Config] [Bandwidth] [7 MHz (8/7)], [8.75 MHz (8/7)], or [10 MHz (28/25)] [Frame Length] <5 ms> or <10 ms> [TTG (RTG)] Enter a value [uSec] [CP Ratio] <1/32>, <1/16>, <1/8>, or <1/4> [DL Symbols] Enter a value [Enter] [UL Symbols] | Press the MEASURE SETUP hot key. Press the System Config soft key. Press the Bandwidth soft key. Press one of the soft keys to select the bandwidth. Press the Frame Length soft key. Toggle between 5 ms and 10 ms to select one. Press the TTG (RTG) soft key. Use the numeric keys to input value. Press the unit soft key to complete the input. Press the CP Ratio soft key. Each time the soft key is pressed the selection moves. Press the DL Symbols soft key. Use the numeric keys to input value. Press the Enter soft key to complete the input. Press the UL Symbols soft key. |

| | |
|------------------------------|--|
| Enter a value [Enter] | Use the numeric keys to input value. Press the Enter soft key to complete the input. |
| [Auto Save] <On> or <Off> | Press the Auto Save soft key. Toggle between On and Off . |

Mobile WiMAX OTA Preamble Scanner Measurement Procedure

MEASURE SETUP



- n **SYSTEM CONFIG:** Sets the system configuration.
- Y **BANDWIDTH:** Selects the nominal channel bandwidths to be measured.
 - **7 MHz (8/7):** Sets the channel bandwidth to 7 MHz with sampling factor 8/7. In conjunction with nominal channel bandwidth.
 - **8.75 MHz (8/7):** Sets the channel bandwidth to 8.75 MHz with sampling factor 8/7.
 - **10 MHz (28/25):** Sets the channel bandwidth to 10 MHz with sampling factor 28/25.
- Y **FRAME LENGTH:** Sets the length of a frame. Toggle this soft key between **5 ms** and **10 ms**.
- Y **TTG (RTG):** Sets the transmit/receive transition gap between the last sample of the downlink (DL) burst and the first sample of the subsequent uplink (UL) burst.
- Y **CP RATIO:** Sets the Cyclic Prefix (CP) ratio among **1/4**, **1/8**, **1/16**, and **1/32**. Each time this soft key is pressed the selection moves. A copy of the last Tg of the useful symbol period, termed CP, is used to collect multipath, while maintaining the orthogonality of the tones.
- Y **DL SYMBOLS:** Sets the number of downlink symbols.
- Y **UL SYMBOLS:** Sets the number of uplink symbols.
- n **AUTO SAVE:** Enables or disables automatic saving of the measurement data to an external USB memory. When it turns on, the measurements will be recorded into the default file (logging.ota) or a user-named file.
- n **MISCELLANEOUS**
 - Y **DELAY:** Sets the delay in micro seconds. This key is used only when there is a time offset in the signals to be measured.

Measurement Example

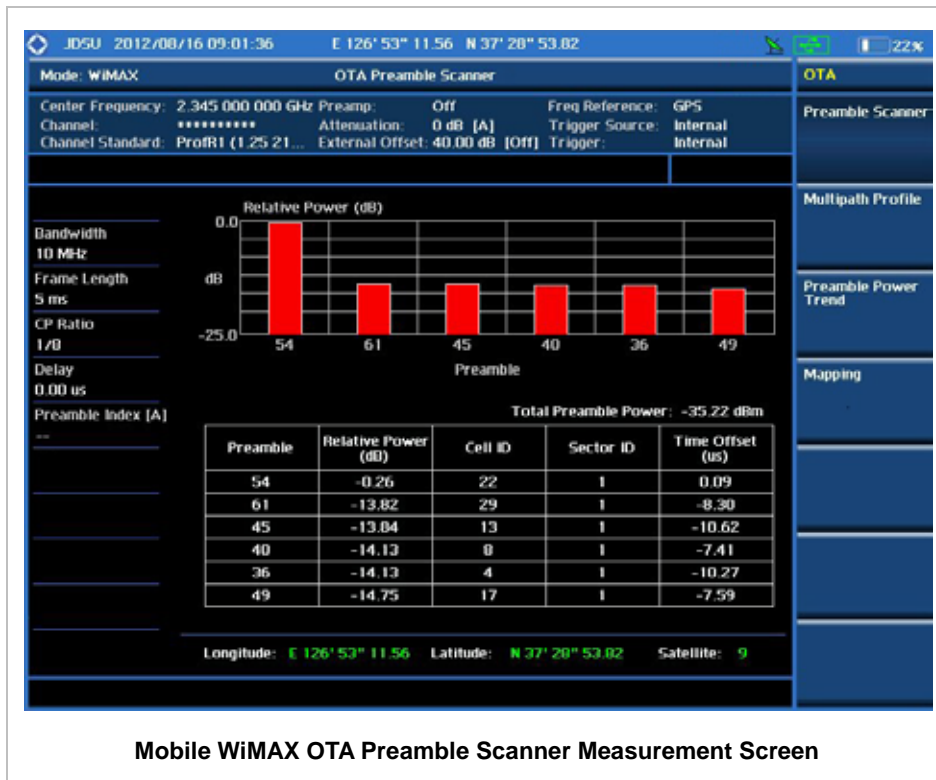

Mobile WiMAX OTA Preamble Scanner Measurement Screen

MOBILE WIMAX OTA MULTIPATH PROFILE

The Multipath Profile enables the user to determine RF environmental conditions of testing area. It indicates the multipath power with time delay in us up to 6.

The multipath profile is the result of portions of the original broadcast signal arriving at the receiving antenna out of phase. This can be caused by the signal being reflected off objects such as buildings, or being refracted through the atmosphere differently from the main signal.

Measurement Procedure

| Step | Description |
|---|---|
| 1. Set the measurement mode MEASURE [OTA] [Multipath Profile] | Press the MEASURE hot key. Press the OTA soft key. Press the Multipath Profile soft key. |
| 2. Set the measurement parameters MEASURE SETUP | Press the MEASURE SETUP hot key. |

| | |
|---|---|
| <p>[System Config]</p> <p>[Bandwidth] [7 MHz (8/7)], [8.75 MHz (8/7)], or [10 MHz (28/25)]</p> <p>[Frame Length] <5 ms> or <10 ms></p> <p>[TTG (RTG)] Enter a value [uSec]</p> <p>[CP Ratio] <1/32>, <1/16>, <1/8>, or <1/4></p> <p>[DL Symbols] Enter a value [Enter]</p> <p>[UL Symbols] Enter a value [Enter]</p> <p>[Preamble Index] <Auto> or <Manual></p> | <p>Press the System Config soft key.</p> <p>Press the Bandwidth soft key.</p> <p>Press one of the soft keys to select the bandwidth.</p> <p>Press the Frame Length soft key. Toggle between 5 ms and 10 ms to select one.</p> <p>Press the TTG (RTG) soft key.</p> <p>Use the numeric keys to input value.</p> <p>Press the unit soft key to complete the input.</p> <p>Press the CP Ratio soft key. Each time the soft key is pressed the selection moves.</p> <p>Press the DL Symbols soft key.</p> <p>Use the numeric keys to input value.</p> <p>Press the Enter soft key to complete the input.</p> <p>Press the UL Symbols soft key.</p> <p>Use the numeric keys to input value.</p> <p>Press the Enter soft key to complete the input.</p> <p>Press the Preamble Index soft key. Toggle between Auto and Manual to select one.</p> |
|---|---|

Mobile WiMAX OTA Multipath Profile Measurement Procedure

MEASURE SETUP



- n **SYSTEM CONFIG:** Sets the system configuration.
- Y **BANDWIDTH:** Selects the nominal channel bandwidths to be measured.
 - **7 MHz (8/7):** Sets the channel bandwidth to 7 MHz with sampling factor 8/7. In conjunction with nominal channel bandwidth.
 - **8.75 MHz (8/7):** Sets the channel bandwidth to 8.75 MHz with sampling factor 8/7.
 - **10 MHz (28/25):** Sets the channel bandwidth to 10 MHz with sampling factor 28/25.
- Y **FRAME LENGTH:** Sets the length of a frame. Toggle this soft key between **5 ms** and **10 ms**.
- Y **TTG (RTG):** Sets the transmit/receive transition gap between the last sample of the downlink (DL) burst and the first sample of the subsequent uplink (UL) burst.
- Y **CP RATIO:** Sets the Cyclic Prefix (CP) ratio among **1/4**, **1/8**, **1/16**, and **1/32**. Each time this soft key is pressed the selection moves. A copy of the last Tg of the useful symbol period, termed CP, is used to collect multipath, while maintaining the orthogonality of the tones.
- Y **DL SYMBOLS:** Sets the number of downlink symbols.

- Y **UL SYMBOLS:** Sets the number of uplink symbols.
- n **PREAMBLE INDEX:** Selects the preamble search methods, **Auto** or **Manual**.
- n **MISCELLANEOUS**
 - Y **DELAY:** Sets the delay in micro seconds. This key is used only when there is a time offset in the signals to be measured.

Measurement Example

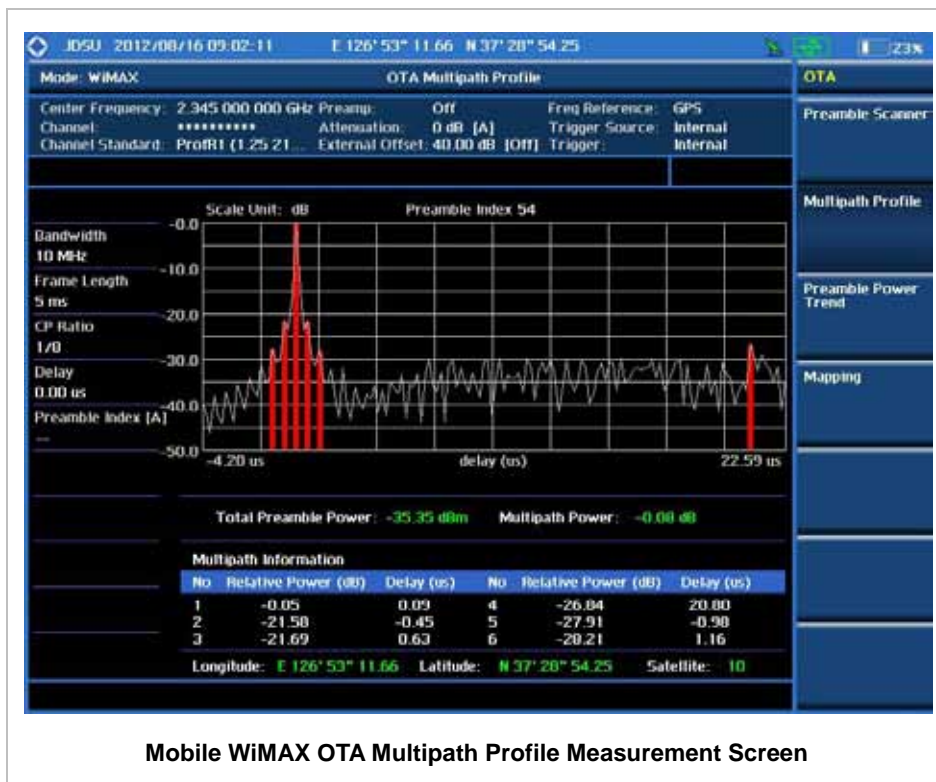

MOBILE WIMAX OTA PREAMBLE POWER TREND

Preamble power trend shows power variations of a strongest preamble signal over time along with the relative power trend compare to total preamble power. Searching preamble index can be set auto to detect strongest or manual to search specific preamble. Positioning information, latitude and longitude will be displayed if a GPS antenna is supplied and locked to the GPS satellites on the bottom of the screen.

Measurement Procedure

| Step | Description |
|---|---|
| 1. Set the measurement mode MEASURE [OTA] [Preamble Power Trend] | Press the MEASURE hot key. Press the OTA soft key. Press the Preamble Power Trend soft key. |
| 2. Set the measurement parameters MEASURE SETUP [System Config] [Bandwidth] [7 MHz (8/7)], [8.75 MHz (8/7)], or [10 MHz (28/25)] [Frame Length] <5 ms> or <10 ms> [TTG (RTG)] Enter a value [uSec] [CP Ratio] <1/32>, <1/16>, <1/8>, or <1/4> [DL Symbols] Enter a value [Enter] [UL Symbols] Enter a value [Enter] [Preamble Index] <Auto> or <Manual> [Auto Save] <On> or <Off> | Press the MEASURE SETUP hot key. Press the System Config soft key. Press the Bandwidth soft key. Press one of the soft keys to select the bandwidth. Press the Frame Length soft key. Toggle between 5 ms and 10 ms to select one. Press the TTG (RTG) soft key. Use the numeric keys to input value. Press the unit soft key to complete the input. Press the CP Ratio soft key. Each time the soft key is pressed the selection moves. Press the DL Symbols soft key. Use the numeric keys to input value. Press the Enter soft key to complete the input. Press the UL Symbols soft key. Use the numeric keys to input value. Press the Enter soft key to complete the input. Press the Preamble Index soft key. Toggle between Auto and Manual to select one. Press the Auto Save soft key. Toggle between On and Off . |

Mobile WiMAX OTA Preamble Power Trend Measurement Procedure

MEASURE SETUP



- n **SYSTEM CONFIG:** Sets the system configuration.
- Y **BANDWIDTH:** Selects the nominal channel bandwidths to be measured.
 - **7 MHz (8/7):** Sets the channel bandwidth to 7 MHz with sampling factor 8/7. In conjunction with nominal channel bandwidth.
 - **8.75 MHz (8/7):** Sets the channel bandwidth to 8.75 MHz with sampling factor 8/7.
 - **10 MHz (28/25):** Sets the channel bandwidth to 10 MHz with sampling factor 28/25.

- Y **FRAME LENGTH:** Sets the length of a frame. Toggle this soft key between **5 ms** and **10 ms**.
- Y **TTG (RTG):** Sets the transmit/receive transition gap between the last sample of the downlink (DL) burst and the first sample of the subsequent uplink (UL) burst.
- Y **CP RATIO:** Sets the Cyclic Prefix (CP) ratio among **1/4**, **1/8**, **1/16**, and **1/32**. Each time this soft key is pressed the selection moves. A copy of the last Tg of the useful symbol period, termed CP, is used to collect multipath, while maintaining the orthogonality of the tones.
- Y **DL SYMBOLS:** Sets the number of downlink symbols.
- Y **UL SYMBOLS:** Sets the number of uplink symbols.
- n **PREAMBLE INDEX:** Selects the preamble search methods, **Auto** or **Manual**.
- n **AUTO SAVE:** Enables or disables automatic saving of the measurement data to an external USB memory. When it turns on, the measurements will be recorded into the default file (logging.ota) or a user-named file.
- n **MISCELLANEOUS**
 - Y **DELAY:** Sets the delay in micro seconds. This key is used only when there is a time offset in the signals to be measured.

Measurement Example

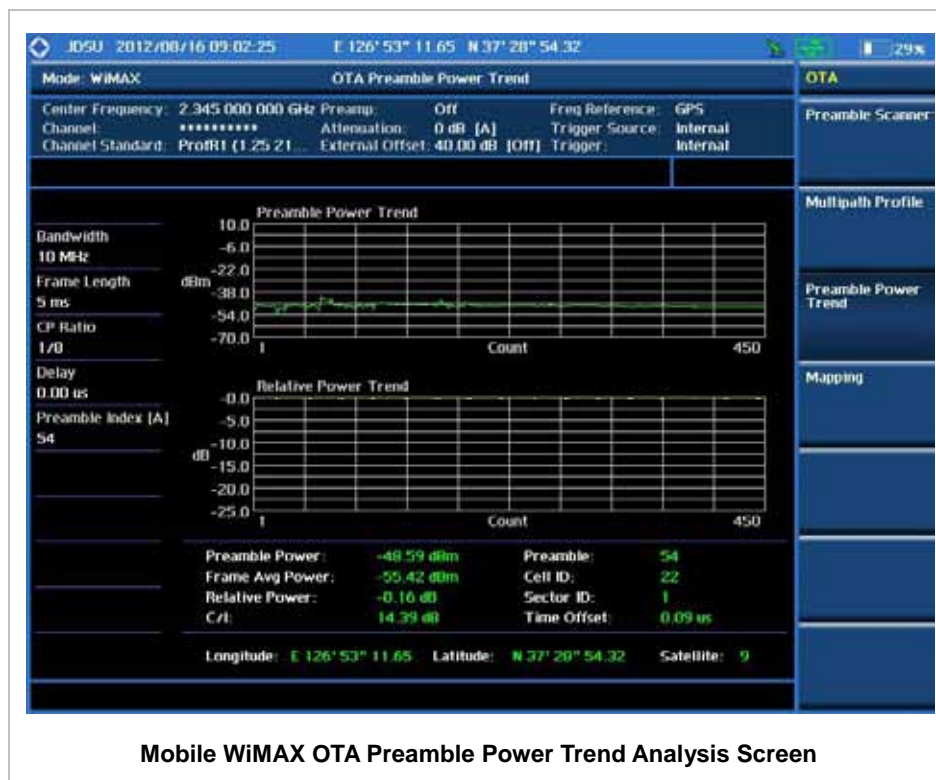

Mobile WiMAX OTA Preamble Power Trend Analysis Screen

MOBILE WIMAX ROUTE MAP

The JD740A Series provides indoor and outdoor mapping function that allows a user to collect data of points in an indoor or outdoor environment and track the received signals and coverage of RF transmitters plotting real time directly on top of a loaded floor plan or a map.

Measurement Procedure

| Step | Description |
|--|---|
| 1. Set the measurement mode MEASURE [OTA] [Route Map] | Press the MEASURE hot key. Press the OTA soft key. Press the Route Map soft key. |
| 2. Set the measurement parameters MEASURE SETUP [Load Map] [Plot Point] [Position] or [GPS] [Screen Mode] <Map> or <Full> [System Config] [Bandwidth] [7 MHz (8/7)], [8.75 MHz (8/7)], or [10 MHz (28/25)] [Frame Length] <5 ms> or <10 ms> [TTG (RTG)] Enter a value [uSec] [CP Ratio] <1/32>, <1/16>, <1/8>, or <1/4> [DL Symbols] | Press the MEASURE SETUP hot key. After plugging in a USB drive, press the Load Map soft key to load a map file created in JDMAPCreator and copied into the USB drive. Press the Plot Point soft key to get option menu. Press the Position soft key without a GPS antenna or the GPS with one. Selecting GPS activates the Screen Mode soft key to be set. Press the Screen Mode soft key. Toggle this key between Map and Full . Press the System Config soft key. Press the Bandwidth soft key. Press one of the soft keys to select the bandwidth. Press the Frame Length soft key. Toggle between 5 ms and 10 ms to select one. Press the TTG (RTG) soft key. Use the numeric keys to input value. Press the unit soft key to complete the input. Press the CP Ratio soft key. Each time the soft key is pressed the selection moves. Press the DL Symbols soft key. |

| | |
|--|---|
| Enter a value [Enter] [UL Symbols] | Use the numeric keys to input value. Press the Enter soft key to complete the input. Press the UL Symbols soft key. |
| Enter a value [Enter] | Use the numeric keys to input value. Press the Enter soft key to complete the input. |
| [Plot] <Start> or <Stop> | Press the Plot soft key to start or stop plotting. Toggle this key between Start and Stop . |

MEASURE SETUP



Sets the measurement parameters for the Route Map. The legend displayed in different colors at the bottom of the screen can be set with the **Limit** hot key.

- n **PLOT:** Starts or stops a measurement in order to plot received signals or collected data on top of a loaded map. Toggle this key between **Start** and **Stop**. The instrument does not automatically save collected data. After stopping the current route mapping, the user needs to save the result with the **Save** hot key for later use. If not, all the collected data for the route will be lost.
- n **PLOT POINT:** Selects a method of plotting points. The instrument collects the strongest Preamble data from its Preamble Scanner and plots them.
 - Y **POSITION:** Measures data without GPS in an indoor environment. After starting to plot, press the **Enter** hard key or the center of the rotary knob as you move with the instrument. Each time the user presses the key or the knob, the instrument plots a point on top of the loaded map. Use the arrow keys to change direction of route and the rotary knob to change distance. If the instrument has the screen with touch screen, directly touch the screen in order to collect data.
 - Y **GPS:** Automatically collects data with GPS in an outdoor environment and plots points as the user moves in a vehicle.
- n **SCREEN MODE:** Selects either **Map** or **Full**, depending on how to show collected points on the screen. Selecting GPS for the Plot Point activates this key. Numbers shown next to the points represent their Cell IDs. The instrument displays Cell ID of the start point and those of the points with different Cell IDs from the right previous ones.
 - Y **MAP:** Displays collected points only that can be seen within the boundary of the loaded map. If a point is off the map, the instrument displays an arrow indicating the direction of the current location on the map and the distance from the center to the location at the top of the screen.
 - Y **FULL:** Displays all the points measured for route on the screen without the map.
- n **LOAD MAP:** Loads a floor plan or a map file created in **JDMapCreator**. The JDMapCreator converts and resizes any scanned floor plan or layout so that it can be loaded and fit to the

instrument display.

- n **SYSTEM CONFIG:** Sets the system configuration.
- Y **BANDWIDTH:** Selects the nominal channel bandwidths to be measured.
 - **7 MHz (8/7):** Sets the channel bandwidth to 7 MHz with sampling factor 8/7. In conjunction with nominal channel bandwidth.
 - **8.75 MHz (8/7):** Sets the channel bandwidth to 8.75 MHz with sampling factor 8/7.
 - **10 MHz (28/25):** Sets the channel bandwidth to 10 MHz with sampling factor 28/25.
- Y **FRAME LENGTH:** Sets the length of a frame. Toggle this soft key between **5 ms** and **10 ms**.
- Y **TTG (RTG):** Sets the transmit/receive transition gap between the last sample of the downlink (DL) burst and the first sample of the subsequent uplink (UL) burst.
- Y **CP RATIO:** Sets the Cyclic Prefix (CP) ratio among **1/4**, **1/8**, **1/16**, and **1/32**. Each time this soft key is pressed the selection moves. A copy of the last Tg of the useful symbol period, termed CP, is used to collect multipath, while maintaining the orthogonality of the tones.
- Y **DL SYMBOLS:** Sets the number of downlink symbols.
- Y **UL SYMBOLS:** Sets the number of uplink symbols.

Setting Limit



This hot key is used to set threshold values for the legend displayed on the screen. The different colors of the legend indicate the quality of the measured data depending on their threshold setting. The user input window must be inactive first to get the Limit hot key function other than the number input.

| Step | Description |
|--|---|
| 1. Set the limit Limit [Excellent] Enter a value [Enter] [Very Good] Enter a value [Enter] [Good] Enter a value | Press the LIMIT hot key to set the threshold. Press the Excellent soft key. Use the rotary knob or the numeric keys. Press the Enter soft key. Press the Very Good soft key. Use the rotary knob or the numeric keys. Press the Enter soft key. Press the Good soft key. Use the rotary knob or the numeric keys. |

| | |
|---------------|--|
| [Enter] | Press the Enter soft key. |
| [Fair] | Press the Fair soft key. |
| Enter a value | Use the rotary knob or the numeric keys. |
| [Enter] | Press the Enter soft key. |
| [Poor] | Press the Poor soft key. |
| Enter a value | Use the rotary knob or the numeric keys. |
| [Enter] | Press the Enter soft key. |

Measurement Example





Route Map Measurement Screen (Full View)

ANALYSIS

Using Marker



Marker is used to get the information about a specific trace. Six markers can be set on the display and each marker can be used independently. The X and Y coordinates of the trace are displayed when the marker is placed on any position of the trace. The position displaying the marker's X and Y coordinates may be slightly different for each measurement mode and refer to the description of each measurement. There are three different marker types available: Normal, Delta, and Delta pair. Marker position can be set manually by entering numeric values (frequency) when one of the marker types is selected.

- n **SELECT MARKER:** Selects an active marker whose position can be changed with the rotary knob or the arrow keys. The assigned number of the active marker is displayed in the **Select Marker** menu box and the active marker number is also displayed right next to the active marker on the trace when the **Marker View** is set to **On**.
- n **MARKER VIEW:** Displays the selected marker on the screen or hides it. When the **Marker View**

is turned off and then on again in the same measurement mode, markers appear at the previous positions. If a measurement mode is changed, markers are not restored to their previous positions.

- n **NORMAL:** This Normal marker type provides the reading of a marker position on the trace along with the marker number between 1 and 6.
- n **DELTA:** This Delta marker type is associated with a Normal marker. A Normal marker must be set before a Delta marker is set. When the Delta marker is set, the position set by the Delta marker becomes the reference position of the Normal marker and the marker's X and Y values displays the difference compared with the Delta marker.
- n **DELTA PAIR:** This Delta Pair marker type is associated with a Normal marker. A Normal marker must be set before a Delta Pair marker is set. When the Delta Pair marker is set, the position set by the Delta Pair marker becomes the reference position of the Normal marker and the marker's X and Y values displays the difference compared with the Delta Pair marker. The reference position will be varied in accordance with trace change.
- n **MARKER ALL OFF:** Turns all the markers the screen off. When the Marker View is selected for those markers, the instrument displays those markers back at the previous position. If a measurement mode is changed, current settings are not restored.
- n **MARKER \rightarrow :** Sets the X coordinate of the active marker as selected.
 - Y **MARKER \rightarrow CENTER:** Sets the frequency of the active marker to the center frequency of spectrum analyzer.
 - Y **MARKER \rightarrow START:** Sets the frequency of the active marker to the start frequency of spectrum analyzer.
 - Y **MARKER \rightarrow STOP:** Sets the frequency of the active marker to the stop frequency of spectrum analyzer.

Using Peak Search

PEAK SEARCH

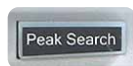

Each time the Peak Search soft key is pressed, the active marker is positioned at the highest peak of the trace.

- n **PEAK SEARCH:** Moves the active marker to the highest peak of the trace.
- n **NEXT PEAK:** Moves the active marker to the second highest peak of the trace.
- n **NEXT PEAK RIGHT:** Moves the active marker to the highest peak to the right of its current position.
- n **NEXT PEAK LEFT:** Moves the active marker to the highest peak to the left of its current position.

- n **MIN SEARCH:** Moves the active marker to the lowest peak of the trace.
- n **ALWAYS PEAK:** When the **Always Peak** is set to On, the instrument moves the active marker automatically to the highest peak of the trace every time the trace is refreshed.

LTE - FDD Signal Analyzer

This FDD LTE Signal Analyzer function is optional that the JD740A series offers as the Option 028. It allows the user to analyze FDD LTE system performance. The user may alter the measurement parameters for specialized analysis. The FDD LTE OTA Analyzer which is the Option 048 can be added to the FDD LTE Signal Analyzer for Over The Air measurement.

In this Chapter

| | |
|--------------------------------------|----|
| Using LTE - FDD Signal Analyzer..... | 5 |
| Display Overview..... | 6 |
| Connecting a Cable..... | 8 |
| Direct Connection..... | 8 |
| Indirect Connection..... | 8 |
| Over The Air (OTA)..... | 9 |
| Spectrum Analysis Measurement..... | 10 |
| Setting Mode..... | 10 |
| Setting Frequency..... | 10 |
| Setting Amplitude..... | 11 |
| Setting Averaging..... | 13 |
| Setting Sweep Mode..... | 13 |
| Setting Trigger Source..... | 13 |
| Setting External Clock..... | 14 |
| Setting Trace and Display..... | 15 |
| Measurement Procedure..... | 16 |
| Measurement Example..... | 16 |
| RF Analysis Measurements..... | 17 |
| Setting Mode..... | 17 |
| Setting Frequency..... | 18 |
| Setting Amplitude..... | 19 |
| Setting Averaging..... | 21 |
| Setting Sweep Mode..... | 21 |
| Setting Trigger Source..... | 21 |
| Setting External Clock..... | 22 |
| Channel Power..... | 23 |
| Measurement Procedure..... | 24 |
| Setting Limit..... | 24 |
| Measurement Example..... | 25 |
| Occupied Bandwidth..... | 26 |
| Measurement Procedure..... | 26 |
| Setting Limit..... | 26 |
| Measurement Example..... | 27 |

| | |
|---|----|
| Spectrum Emission Mask (SEM)..... | 27 |
| Measurement Procedure | 28 |
| Setting Limit | 28 |
| Measurement Example | 29 |
| ACLR | 30 |
| Measurement Procedure | 30 |
| Setting Limit | 30 |
| Measurement Example | 31 |
| Multi-ACLR | 31 |
| Measurement Procedure | 32 |
| Setting Limit | 33 |
| Measurement Example | 34 |
| Spurious Emissions | 34 |
| Measurement Procedure | 34 |
| Setting Limit | 36 |
| Measurement Example | 37 |
| Power vs Time (Frame) Measurement | 37 |
| Setting Mode | 38 |
| Setting Frequency | 38 |
| Setting Amplitude | 39 |
| Setting Sweep Mode | 40 |
| Setting Trigger Source | 41 |
| Setting External Clock | 41 |
| Measurement Procedure | 43 |
| Measurement Example | 44 |
| Modulation Analysis Measurements | 44 |
| Setting Mode | 44 |
| Setting Frequency | 45 |
| Setting Amplitude | 46 |
| Setting Sweep Mode | 48 |
| Setting Trigger Source | 48 |
| Setting External Clock | 48 |
| Constellation | 50 |
| Measurement Procedure | 50 |
| Setting Limit | 52 |
| Measurement Example | 54 |
| Data Channel | 55 |
| Measurement Procedure | 55 |
| Setting Limit | 56 |
| Measurement Example | 58 |
| Using Marker | 59 |
| Control Channel | 59 |
| Measurement Procedure | 60 |
| Setting Limit | 61 |
| Measurement Example | 63 |
| Using Marker | 63 |
| Subframe | 64 |
| Measurement Procedure | 64 |
| Setting Limit | 66 |
| Setting Display | 70 |
| Measurement Example | 70 |
| Using Marker | 71 |
| Frame | 71 |

| | |
|---------------------------------------|-----|
| Measurement Procedure | 71 |
| Setting Limit | 73 |
| Measurement Example | 77 |
| Time Alignment Error | 78 |
| Measurement Procedure | 78 |
| Setting Limit | 79 |
| Measurement Example | 81 |
| Data Allocation Map | 81 |
| Measurement Procedure | 82 |
| Measurement Example | 83 |
| Using Marker | 83 |
| Auto Measurements | 84 |
| Setting Mode | 84 |
| Setting Trigger Source | 84 |
| Setting External Clock | 84 |
| Conformance Test | 86 |
| Setting Limit | 86 |
| Measurement Procedure | 91 |
| Maintenance Test | 94 |
| Setting Frequency | 94 |
| Setting Limit | 95 |
| Measurement Procedure | 103 |
| Setting Display | 105 |
| Signal Performance Test | 106 |
| Setting Frequency | 106 |
| Setting Sweep Mode | 107 |
| Setting Limit | 107 |
| Measurement Procedure | 112 |
| Power Statistics CCDF | 113 |
| Setting Mode | 113 |
| Setting Frequency | 113 |
| Setting Amplitude | 115 |
| Setting Sweep Mode | 116 |
| Setting Trigger Source | 116 |
| Setting External Clock | 116 |
| Measurement Procedure | 118 |
| Measurement Example | 118 |
| LTE - FDD OTA Measurements | 119 |
| Setting Mode | 119 |
| Setting Frequency | 120 |
| Setting Amplitude | 121 |
| Setting Sweep Mode | 122 |
| Setting Trigger Source | 123 |
| Setting External Clock | 123 |
| LTE - FDD OTA ID Scanner | 124 |
| Measurement Procedure | 125 |
| Measurement Example | 126 |
| LTE - FDD OTA Multipath Profile | 126 |
| Measurement Procedure | 126 |
| Measurement Example | 127 |
| LTE - FDD OTA Control Channel | 128 |
| Measurement Procedure | 128 |
| Measurement Example | 129 |

LTE - FDD OTA Datagram 130
 Measurement Procedure 130
 Measurement Example 132
LTE - FDD Route Map 132
 Measurement Procedure 132
 Setting Limit 134
 Measurement Example 137
Analysis 138
 Using Marker 139
 Using Peak Search 140

(Rev. 6.0)

USING LTE - FDD SIGNAL ANALYZER

The LTE (Long Term Evolution) Signal Analyzer of the JD740A series performs power and spectrum measurements as well as modulation analysis to test the proper transmitter performance of FDD LTE systems. It performs conformance testing according to the following standards providing a simple Pass/Fail indication on each test.

- n 3GPP TS 36.104. Evolved Universal Terrestrial Radio Access (E-UTRA); Base Station (BS) Radio Transmission and Reception
- n 3GPP TS 36.141. Evolved Universal Terrestrial Radio Access (E-UTRA); Base Station (BS) Conformance Testing
- n 3GPP TS 36.211. Evolved Universal Terrestrial Radio Access (E-UTRA); Physical Channels and Modulation
- n 3GPP TS 36.212. Evolved Universal Terrestrial Radio Access (E-UTRA); Multiplexing and Channel Coding
- n 3GPP TS 36.213 V8.2.0. Evolved Universal Terrestrial Radio Access (E-UTRA); Physical Layer Procedures

The LTE - FDD Signal Analyzer of the JD740A series provides the following analysis tools for FDD LTE system. The user may alter the measurement parameters for specialized analysis.

- n Spectrum Analysis
- n RF Analysis
 - Y Channel Power
 - Y Occupied Bandwidth
 - Y Spectrum Emission Mask
 - Y Adjacent Channel Leakage power Ratio (ACLR)
 - Y Multi-ACLR
 - Y Spurious Emissions
- n Power vs Time (Frame)
- n Modulation Analysis
 - Y Constellation
 - Y Data Channel

- Y Control Channel
- Y Subframe
- Y Frame
- Y Time Alignment Error
- Y Data Allocation Map
- n Auto Measure
 - Y Conformance Test
 - Y Maintenance Test
 - Y Signal Performance Test
- n Power Statistics CCDF
- n Over The Air (OTA)
 - Y ID Scanner
 - Y Multipath Profile
 - Y Control Channel
 - Y Datagram
 - Y Route Map

DISPLAY OVERVIEW

Measurement Mode Information: LTE - FDD Signal Analyzer

Spectrum Input Level Setting Information: This window shows the most common settings or parameters of each measurement.

- Frequency and Channel Setting
- Amplitude Setting (Preamp, Attenuation, External Offset)
- Reference Setting (Frequency, Trigger)

Measurement Setting Information

- Spectrum Analyzer Operation Mode
- Detector Type Setting
- Spectrum Setting (RBW, VBW)
[A]: Auto mode, [M]: Manual mode
- Average Number Setting (the number of traces to be averaged)
- Bandwidth Setting

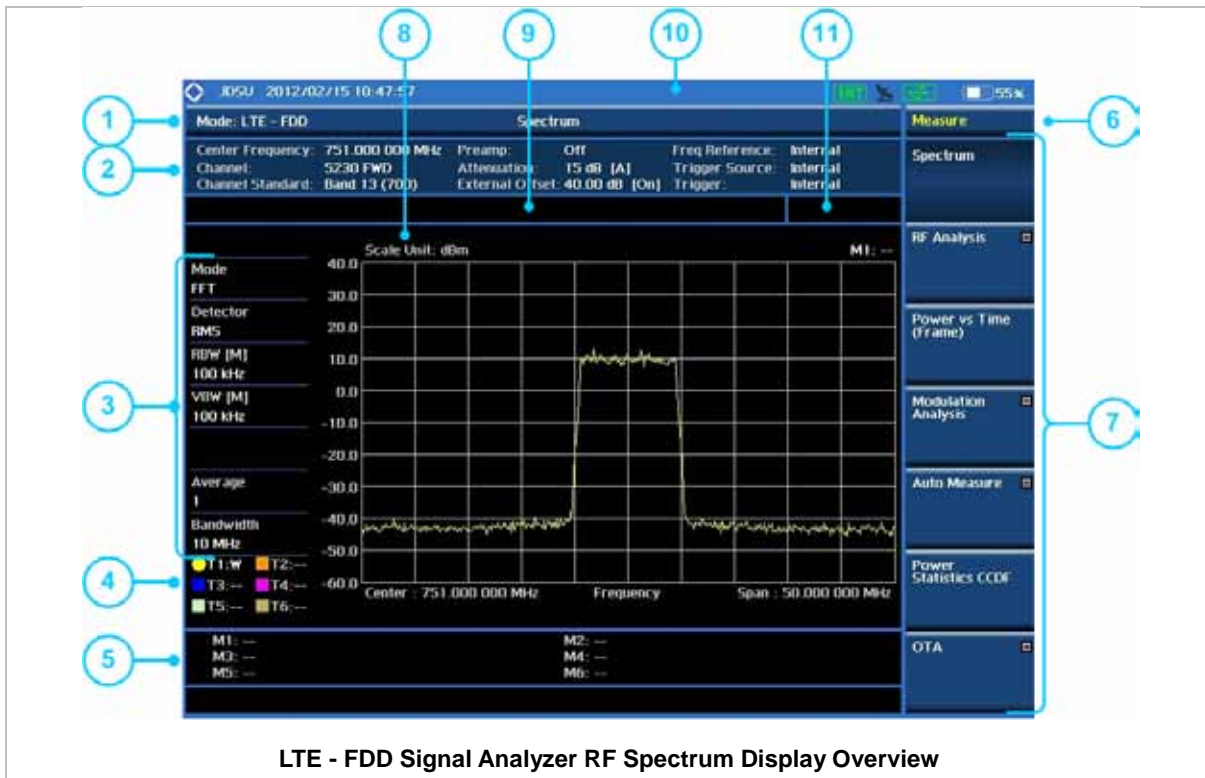

Trace Information

- C: Captured
- M: Max Hold
- m: Min Hold
- W: Write Current Trace (Indicates current active trace)
- L: Loaded
- F: Trace View Off

Information on Marker Table displays up to 6 markers

Screen Menu Title

Screen Menu and Sub-menu

Scale Unit Information: dBm, dBV, dBmV, dBuV, V, and W

User Input Window: Activates when user input menu or key is selected. Pressing ESC hard key will cancel or deactivate user input window. Inactivate user input window before using hot keys.

NOTE: It is very important to inactivate the user input window when you intend to use the hot key menu on the numeric keys.

System Information

- Date and Time
- Positioning Information (Longitude and Latitude). It is available only when a GPS antenna is connected. Frequency reference is automatically set to GPS in the System menu when a GPS antenna is connected.
- Frequency Reference Indicator: INT for internal and EXT for external. The EXT icon is green when an external reference is locked or red when the external reference is not

locked. When a GPS antenna is connected, this space will be blank.

- GPS Indicator: Color of the GPS icon changes among green, yellow and gray depending on locking status.
- USB Indicator
- DC Input Power Indicator
- Battery Indicator

Pass/Fail Indicator

CONNECTING A CABLE

Direct Connection

Connect the **Spectrum Analyzer RF In 50 Ω** port of the JD740A series and the PA output port of BTS.

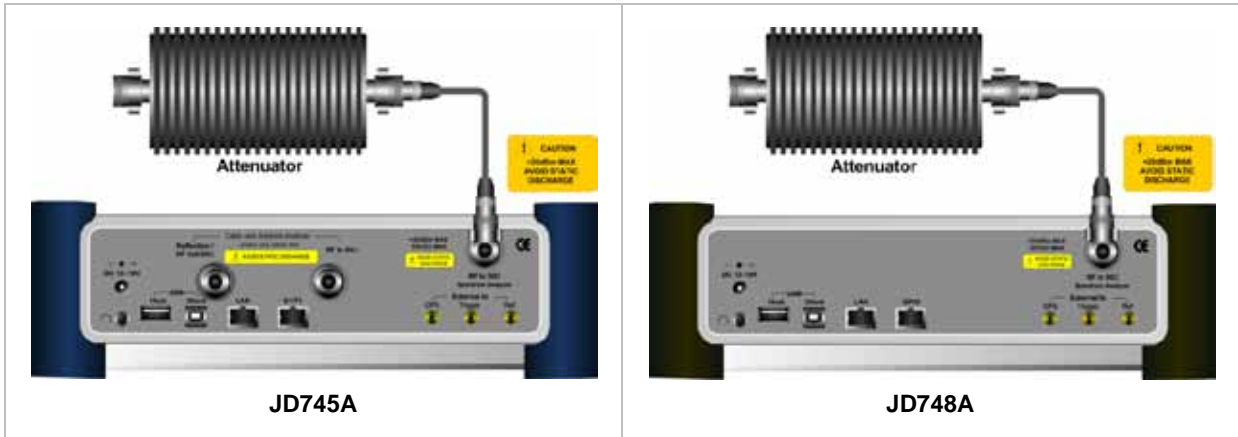

Indirect Connection

Connect the **Spectrum Analyzer RF In 50 Ω** port of the JD740A series and the monitor port of BTS.

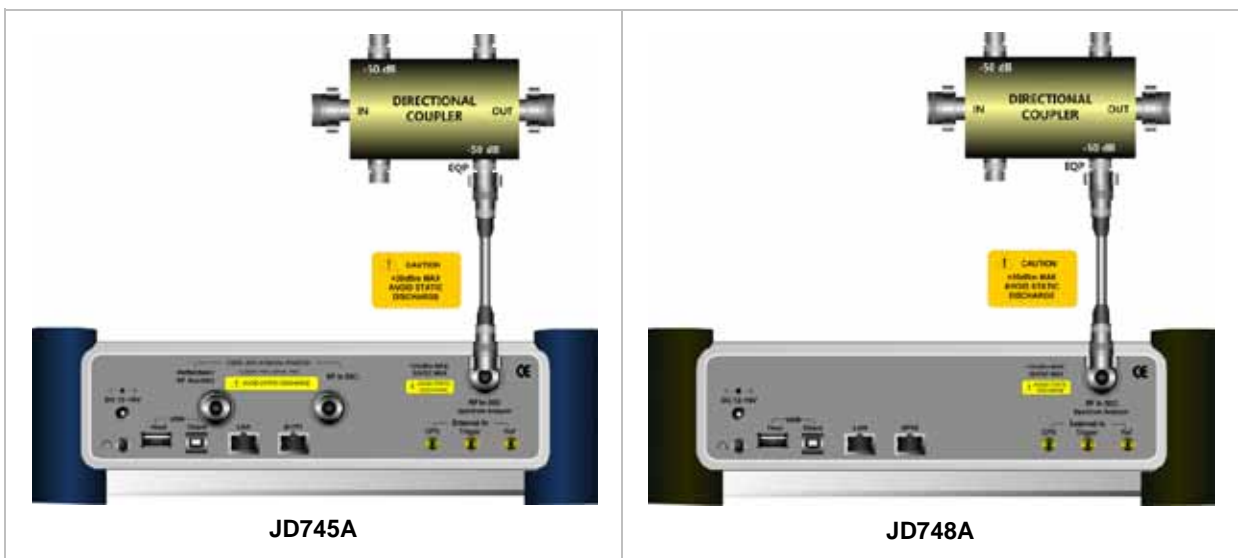





The maximum power for the **Spectrum Analyzer RF In 50 Ω** port is +20 dBm (0.1 Watt). If the input signal level to be measured is greater than +20 dBm, use a **High Power Attenuator** to prevent damage when you directly connect the signal to the instrument. Or connect a signal from the coupling port of a directional coupler.

Over The Air (OTA)

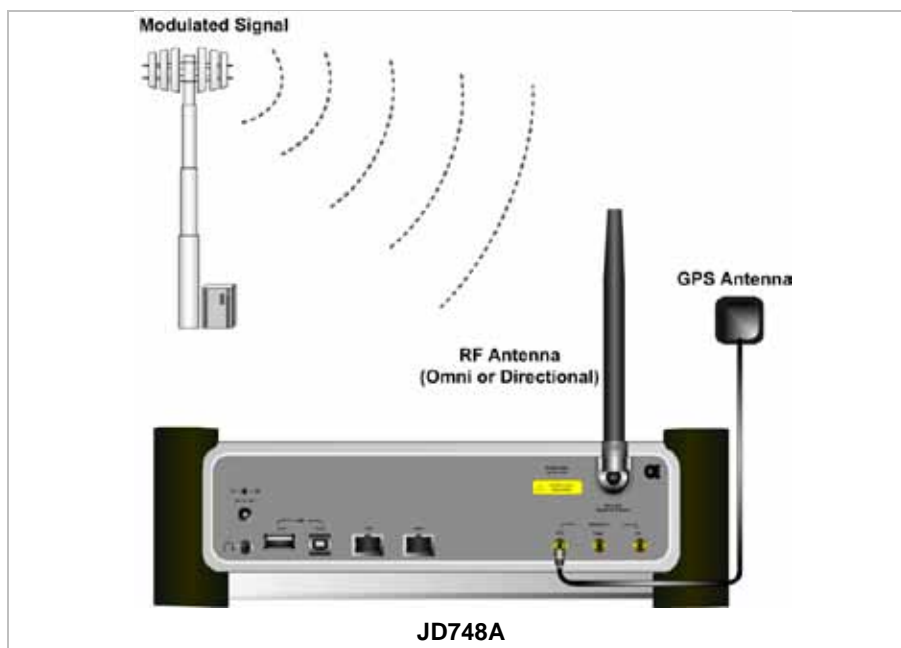
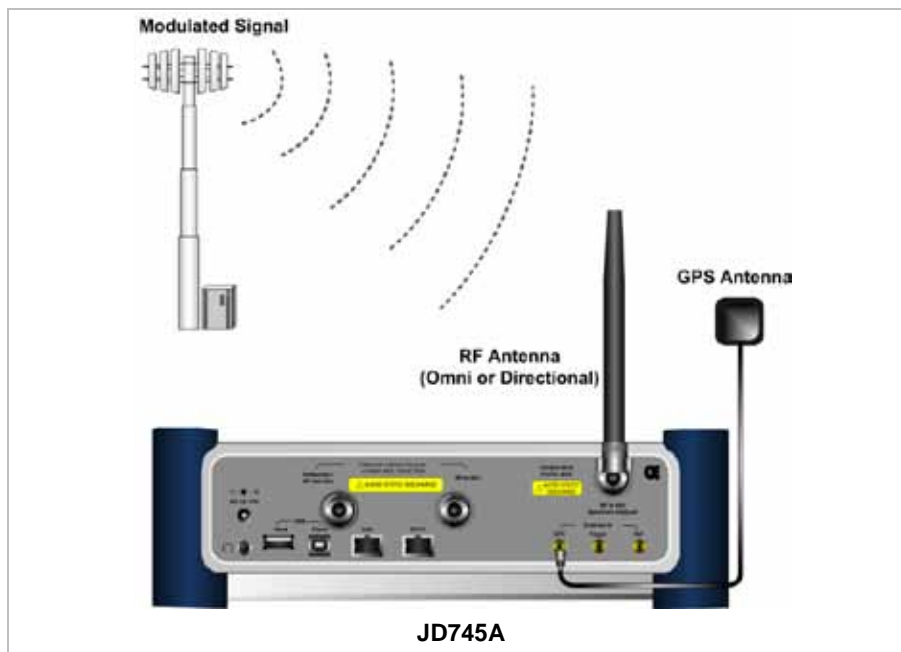
Connect an Omni/directional RF antenna to the **Spectrum Analyzer RF In 50 Ω** port of the JD740A series and then a GPS antenna to the **GPS** port of the JD740A series.



| | |
|---|--|
|  | <p>If the input signal level to be measured is less than 0 dBm, set 0 dB attenuation or turn on the preamp to have better dynamic range for the OTA testing.</p> |
|---|--|

SPECTRUM ANALYSIS MEASUREMENT

Setting Mode

| Step | Description |
|---|---|
| 1. Connect the cable | Connect a cable directly or indirectly as shown in the section Connecting a Cable on page 8 of this chapter. |
| 2. Select the mode MODE [Signal Analyzer] [LTE - FDD] [Spectrum] | <p>Press the MODE hard key.</p> <p>Press the Signal Analyzer soft key.</p> <p>Press the LTE - FDD soft key to select FDD LTE mode.</p> <p>Press the Spectrum soft key. (Spectrum mode is set by default.)</p> |

Setting Frequency

| Step | Description |
|---|---|
| 1. Set the frequency FREQ/DIST [Unit] <Freq> or <Channel> | <p>Press the FREQ/DIST hard key.</p> <p>Press the Unit soft key. Toggle this key between Freq and Channel. A set of Freq/Dist screen menu changes accordingly.</p> |
| <p><u>When Freq is selected:</u></p> <p>[Center Frequency] Enter a value [GHz], [MHz], [kHz], or [Hz]</p> | |
| <p><u>When Channel is selected:</u></p> <p>[Channel Standard]</p> <p>Select a channel standard</p> | <p>Press the Center Frequency soft key.</p> <p>Use the numeric keys, the rotary knob, or the arrow keys.</p> <p>When using the numeric keys, the input is completed by selecting one of the unit soft keys.</p> <p>Press the Channel Standard soft key. If this channel standard shows its default setting Band Global, go set the channel number directly.</p> <p>Press the arrow keys, rotate the knob, or press the Page Up</p> |

| | |
|---|--|
| <p>[Select] or ENTER</p> | <p>and Page Down soft keys to highlight a frequency band to select. Press the Select soft key or the ENTER hard key.</p> |
| <p>[Channel Number] Enter a value [Forward]</p> | <p>Press the Channel Number soft key. Use the numeric keys to input value and press the Forward soft key to complete the input. The instrument automatically displays its corresponding center frequency value for the channel number.</p> |

FREQ/DIST



- n **UNIT:** Determines the way how to set the frequency band either with standard band or custom frequency band. Toggling this key between **Freq** and **Channel** changes a set of Freq/Dist screen menu automatically. When the **Channel** is selected, the instrument sets the **Channel Standard** setting to **Band Global** as default so that the user can set the **Channel Number** directly without choosing a standard channel band from the list.
- n **CENTER FREQUENCY:** Changes the center frequency setting. Use the rotary knob or the arrow keys. Or use the numeric keys to input a certain value and press one of the unit soft keys to complete the input.
- n **FREQUENCY STEP:** Defines the amount of frequency to be increased or decreased when using the rotary knob or the arrow keys to change the **Center Frequency**. This frequency step size can be entered by using numeric keys and the unit soft keys.
- n **CHANNEL NUMBER:** Enters a channel number. The instrument automatically displays its corresponding center frequency value for the channel number.
- n **CHANNEL STEP:** Defines the amount of channel to be increased or decreased when using the rotary knob or the arrow keys to change the **Channel Number**. This channel step size can be entered by using numeric keys and the **Enter** soft key.
- n **CHANNEL STANDARD:** When the channel standard is selected from the list, the center frequency information on the display screen will be mapped accordingly to the selected channel standard. The channel standards available in the instrument are listed in the Appendix C – Band, Frequency & Channel Standard.

Setting Amplitude

| Step | Description |
|--|---|
| <p>1. Set the reference/attenuation level AMP/SCALE</p> | <p>Press the AMP/SCALE hard key.</p> |

| | |
|---|---|
| <p>[Auto Scale]</p> <p>or</p> | <p>Press the Auto Scale soft key to automatically set optimum levels of reference and attenuation.</p> |
| <p>[Reference Level] Enter a reference level value</p> | <p>Press the Reference Level soft key to set manually. Use the numeric keys or the rotary knob that changes in a 10 dB step.</p> |
| <p>[dBm] or ENTER</p> | <p>Press the dBm soft key or the ENTER hard key.</p> |
| <p>[Attenuation] <Manual></p> | <p>Press the Attenuation soft key. The Auto mode is set by default. This key toggles between the Auto and Manual. Press the Attenuation soft key to highlight the Manual mode and change the attenuation value to optimize S/N.</p> |
| <p>Enter an attenuation value</p> | <p>Use the numeric keys or the rotary knob that changes in a 5 dB step. The attenuation setting range is 0 to 50 dB.</p> |

AMP/SCALE



- n **AUTO SCALE:** The instrument can automatically set the scale to the minimum and maximum values on the Y-axis of the graph for optimum display of the traces measured. Each time the **Auto Scale** is selected, the top and bottom scales are set to the minimum and maximum values with margin on the Y-axis of the display screen.
- n **REFERENCE LEVEL:** Sets the maximum Y-axis range.
- n **SCALE/DIV:** Is used only for the Spectrum measurement screen. It represents the value of one division on the horizontal scale. The default value is 10 dB per division and the Y-Scale is set to 100 dB. Selecting the **Scale/Div** soft key enables to set the value to 1 dB per division with the numeric keys or the rotary knob.
- n **ATTENUATION**
 - Y **AUTO:** Input attenuator's value is automatically set depending on the reference level. This is the default operation mode, so it is recommended to use this mode unless a special measurement condition is needed.
 - Y **MANUAL:** Sets the attenuator's value for the **Spectrum Analyzer RF In 50 Ω** port.
- n **PREAMP:** Turns on or off the internal pre-amplifier. Preamp results in a correction being applied to compensate for the gain of the preamp so that amplitude readings show the value at the input connector. This soft key toggles between the **On** and **Off**. When it is set to On, the allowable attenuation input range is from 0 dB to 10 dB in a multiple of 5. If the attenuation value is manually set greater than 10 dB, the instrument will automatically turn off the pre-amplifier to display low level signal properly on the screen.

- n **UNITS:** Sets the scale unit on the display among **dBm**, **dBV**, **dBmV**, **dBuV**, **V**, and **W**.
- n **EXTERNAL OFFSET:** Sets an external offset value. An offset consists of a cable loss and a user offset and the measurement result shows the value reflecting both offset values. When the external offset value is set at 40 dB in the Spectrum mode, the measurement result compensates 40 dB at both the Spectrum Analyzer and Signal Analyzer modes.

Setting Averaging

BW/AVG



- n **AVERAGE:** Sets the number of measurements to be averaged for the trace presentation. A maximum of 100 times of averaging can be set.

| Step | Description |
|---|--|
| 1. Set the averaging BW/AVG [Average] | Press the BW/AVG hard key. Press the Average soft key. |
| 2. Enter number of averaging to set | Use the numeric keys and input a number between 1 and 100. When the averaging reaches to the number set here, a new measurement value replaces the earliest measurement value in sequence. |
| 3. [Enter] or ENTER | Press the Enter soft key or the ENTER hard key. |

Setting Sweep Mode

SWEEP



This hot key is used to set the sweep parameters. The user input window must be inactive first to get the Sweep hot key function other than the number input.

- n **SWEEP MODE:** Sets the sweep method. Toggle between **Continue** and **Single**.

| Step | Description |
|--|---|
| 1. Set the sweep mode SWEEP [Sweep Mode] | Press the SWEEP hot key. Press the Sweep Mode soft key. Toggle between Continue and Single . |

Setting Trigger Source

TRIGGER



This hot key is used to select the trigger source among **Internal**, **External**, and **GPS**. The user input window must be inactive first to get the Trigger hot key function other than the number input.

Setting External Clock

To enhance the reliability of modulation analysis measurements the JD740A series must be synchronized with the Base Station. When an external clock is not supplied, the JD740A series works with a built-in internal high-accuracy time base. In this case, some measurement results may exhibit inaccurate values. Therefore, it is highly recommended to use the same reference clock as signal source. Trigger mode can be changed by using the **TRIGGER** hot key.

EXTERNAL CLOCK OPERATING STANDARDS

| Clock | Type | Reference | Port | Switching Standard |
|--------------------|----------|--------------------|---------------|--|
| External Reference | Internal | Internal 10 MHz | | Default |
| | External | External Ref Clock | Ext Ref (SMA) | Manual switching (Input signal level >-3 dBm) |
| | GPS | GPS Clock | GPS (SMA) | Automatic switching (GPS signal received) |
| Trigger | Internal | Internal Trigger | | Default |
| | External | External Trigger | Trigger (SMA) | Manual switching |
| | GPS | GPS | GPS (SMA) | Manual switching |

CONNECTION

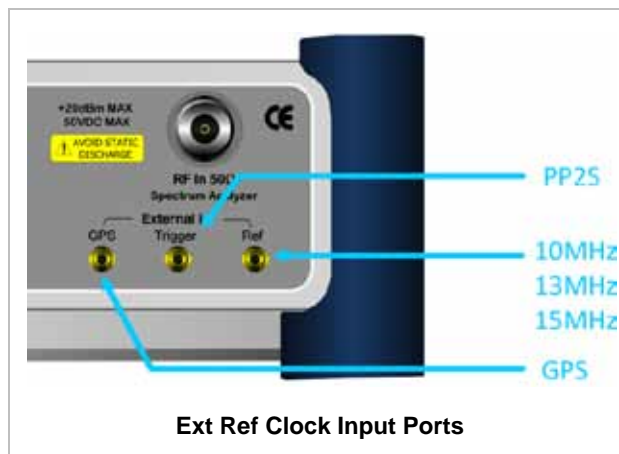

ENABLING EXTERNAL REFERENCE

| Step | Description |
|---|--|
| 1. Connect an external reference | Connect one of the external references or a GPS antenna to the JD740A series. |
| 2. Change reference clock SYSTEM [Frequency Reference] [External 10 MHz], [External 13 MHz], [External 15 MHz] or [GPS] | Press the SYSTEM hot key. Press the Frequency Reference soft key to select one of the external reference clocks or GPS. Press one of the soft keys to choose among External 10 MHz , External 13 MHz , External 15 MHz , and GPS . |

EXTERNAL REFERENCE INDICATOR INFORMATION

Each indicator tells different locking status according to a connection. When a GPS antenna is connected, longitude and latitude information will be displayed on the screen.

| Type | Indicator | Description |
|----------|--|----------------------------------|
| Internal |  (Green) | Locked |
| External |  (Green) | Locked |
| |  (Red) | Unlocked |
| GPS |  (Green) | Locked |
| |  (Yellow) | Locking in progress |
| |  (Gray) | Unable to lock or antenna failed |

Setting Trace and Display

TRACE/DISPLAY



- n **SELECT TRACE:** Selects an active trace from T1 to T6. Trace numbers are assigned to each captured trace or loaded trace. Pressing one of the 6 trace number soft keys sets the selected trace number as the active trace on the display screen.
- n **CLEAR WRITE:** Clears the selected trace and writes or assigns the current trace.
- n **MAX HOLD:** Sets the active trace to display the maximum response of the input signal. Active trace compares newly acquired data with the trace shown on the screen and displays the bigger trace on the display screen.

- n **MIN HOLD:** Sets the active trace to display the minimum response of the input signal. Active trace compares newly acquired data with the trace shown on the screen and displays the smaller trace on the display screen.
- n **CAPTURE:** Captures a current trace on the display screen with the selected trace number.
- n **TRACE VIEW:** Displays the trace of the selected trace number on the display screen or hides it from the display screen. Press the **Select Trace** soft key to select a trace number and then press the **Trace View** soft key to toggle between the **Off** to hide and **On** to restore a hidden trace.
- n **TRACE CLEAR ALL:** Deletes all traces from the instrument and initializes the trace settings.

Measurement Procedure

| Step | Description |
|---|--|
| 1. Select the mode MEASURE [Spectrum] | Press the MEASURE hot key. Press the Spectrum soft key. |
| 2. Set the measurement parameters MEASURE SETUP [Bandwidth] [1.4 MHz], [3 MHz], [5 MHz], [10 MHz], [15 MHz], or [20 MHz] | Press the MEASURE SETUP hot key. Press the Bandwidth soft key. Press one of the soft keys to select. |

LTE - FDD Spectrum Measurement Procedure

MEASURE SETUP



- n **BANDWIDTH:** Selects the nominal channel bandwidth to be measured among **1.4 MHz**, **3 MHz**, **5 MHz**, **10 MHz**, **15 MHz**, and **20 MHz**.

Measurement Example

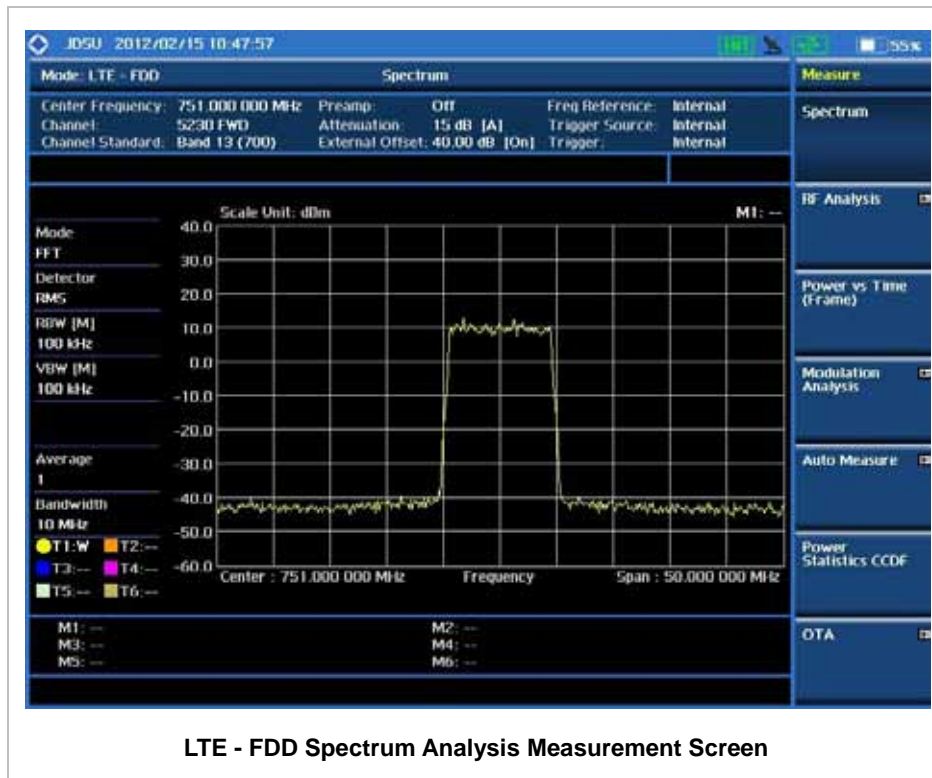

RF ANALYSIS MEASUREMENTS

RF Analysis in LTE - FDD Signal Analyzer provides single-button measurements for the following measurements.

- n Channel Power
- n Occupied Bandwidth
- n Spectrum Emission Mask
- n Adjacent Channel Leakage power Ratio (ACLR)
- n Multi-ACLR
- n Spurious Emissions

Setting Mode

| Step | Description |
|----------------------|--|
| 1. Connect the cable | Connect a cable directly or indirectly as shown in the |

| | |
|--|--|
| | section Connecting a Cable on page 8 of this chapter. |
| <p>2. Select the mode</p> <p>MODE</p> <p> [Signal Analyzer]</p> <p> [LTE - FDD]</p> <p> [RF Analysis]</p> <p> [Channel Power],</p> <p> [Occupied BW],</p> <p> [Spectrum Emission Mask],</p> <p> [ACLR], [Multi-ACLR], or</p> <p> [Spurious Emissions]</p> | <p>Press the MODE hard key.</p> <p>Press the Signal Analyzer soft key.</p> <p>Press the LTE - FDD soft key.</p> <p>Press the RF Analysis soft key.</p> <p>Press one of the measurement mode soft keys to select.</p> |

Setting Frequency

This setting is not used in the Multi-ACLR mode and the Spurious Emissions mode.

| Step | Description |
|---|--|
| <p>1. Set the frequency</p> <p>FREQ/DIST</p> <p> [Unit]</p> <p> <Freq> or <Channel></p> <p> </p> <p><i>When Freq is selected:</i></p> <p> [Center Frequency]</p> <p> Enter a value</p> <p> [GHz], [MHz], [kHz], or [Hz]</p> <p> </p> <p><i>When Channel is selected:</i></p> <p> [Channel Standard]</p> <p> Select a channel standard</p> <p> </p> <p> [Select] or ENTER</p> <p> </p> <p> [Channel Number]</p> <p> Enter a value</p> <p> [Forward]</p> | <p>Press the FREQ/DIST hard key.</p> <p>Press the Unit soft key. Toggle this key between Freq and Channel. A set of Freq/Dist screen menu changes accordingly.</p> <p>Press the Center Frequency soft key.</p> <p>Use the numeric keys, the rotary knob, or the arrow keys.</p> <p>When using the numeric keys, the input is completed by selecting one of the unit soft keys.</p> <p>Press the Channel Standard soft key. If this channel standard shows its default setting Band Global, go set the channel number directly.</p> <p>Press the arrow keys, rotate the knob, or press the Page Up and Page Down soft keys to highlight a frequency band to select.</p> <p>Press the Select soft key or the ENTER hard key.</p> <p>Press the Channel Number soft key.</p> <p>Use the numeric keys to input value and press the Forward soft key to complete the input. The instrument automatically displays its corresponding center frequency value for the</p> |

| | |
|--|-----------------|
| | channel number. |
|--|-----------------|

FREQ/DIST 

- n **UNIT:** Determines the way how to set the frequency band either with standard band or custom frequency band. Toggling this key between **Freq** and **Channel** changes a set of Freq/Dist screen menu automatically. When the **Channel** is selected, the instrument sets the **Channel Standard** setting to **Band Global** as default so that the user can set the **Channel Number** directly without choosing a standard channel band from the list.
- n **CENTER FREQUENCY:** Changes the center frequency setting. Use the rotary knob or the arrow keys. Or use the numeric keys to input a certain value and press one of the unit soft keys to complete the input.
- n **FREQUENCY STEP:** Defines the amount of frequency to be increased or decreased when using the rotary knob or the arrow keys to change the **Center Frequency**. This frequency step size can be entered by using numeric keys and the unit soft keys.
- n **CHANNEL NUMBER:** Enters a channel number. The instrument automatically displays its corresponding center frequency value for the channel number.
- n **CHANNEL STEP:** Defines the amount of channel to be increased or decreased when using the rotary knob or the arrow keys to change the **Channel Number**. This channel step size can be entered by using numeric keys and the **Enter** soft key.
- n **CHANNEL STANDARD:** When the channel standard is selected from the list, the center frequency information on the display screen will be mapped accordingly to the selected channel standard. The channel standards available in the instrument are listed in the Appendix C – Band, Frequency & Channel Standard.

Setting Amplitude

| Step | Description |
|---|--|
| 1. Set the reference/attenuation level AMP/SCALE [Auto Scale] or | Press the AMP/SCALE hard key. Press the Auto Scale soft key to automatically set optimum levels of reference and attenuation. |

| | |
|---|---|
| <p>[Reference Level] Enter a reference level value</p> | <p>Press the Reference Level soft key to set manually. Use the numeric keys or the rotary knob that changes in a 10 dB step.</p> |
| <p>[dBm] or ENTER</p> | <p>Press the dBm soft key or the ENTER hard key.</p> |
| <p>[Attenuation]</p> | <p>Press the Attenuation soft key. The Auto mode is set by default. This key toggles between the Auto and Manual.</p> |
| <p><Manual></p> | <p>Press the Attenuation soft key to highlight the Manual mode and change the attenuation value to optimize S/N.</p> |
| <p>Enter an attenuation value</p> | <p>Use the numeric keys or the rotary knob that changes in a 5 dB step. The attenuation setting range is 0 to 50 dB.</p> |

AMP/SCALE



- n **AUTO SCALE:** The instrument can automatically set the scale to the minimum and maximum values on the Y-axis of the graph for optimum display of the traces measured. Each time the **Auto Scale** is selected, the top and bottom scales are set to the minimum and maximum values with margin on the Y-axis of the display screen.
- n **REFERENCE LEVEL:** Sets the maximum Y-axis range.
- n **SCALE/DIV:** Is used only for the Spectrum measurement screen. It represents the value of one division on the horizontal scale. The default value is 10 dB per division and the Y-Scale is set to 100 dB. Selecting the **Scale/Div** soft key enables to set the value to 1 dB per division with the numeric keys or the rotary knob.
- n **ATTENUATION**
 - Y **AUTO:** Input attenuator's value is automatically set depending on the reference level. This is the default operation mode, so it is recommended to use this mode unless a special measurement condition is needed.
 - Y **MANUAL:** Sets the attenuator's value for the **Spectrum Analyzer RF In 50 Ω** port.
- n **PREAMP:** Turns on or off the internal pre-amplifier. Preamp results in a correction being applied to compensate for the gain of the preamp so that amplitude readings show the value at the input connector. This soft key toggles between the **On** and **Off**. When it is set to On, the allowable attenuation input range is from 0 dB to 10 dB in a multiple of 5. If the attenuation value is manually set greater than 10 dB, the instrument will automatically turn off the pre-amplifier to display low level signal properly on the screen.
- n **UNITS:** Sets the scale unit on the display among **dBm**, **dBV**, **dBmV**, **dBuV**, **V**, and **W**.
- n **EXTERNAL OFFSET:** Sets an external offset value. An offset consists of a cable loss and a user offset and the measurement result shows the value reflecting both offset values. When the external offset value is set at 40 dB in the Spectrum mode, the measurement result compensates

40 dB at both the Spectrum Analyzer and Signal Analyzer modes.

Setting Averaging



- n **AVERAGE:** Sets the number of measurements to be averaged for the trace presentation. A maximum of 100 times of averaging can be set. *This setting is not used in the Spurious Emissions mode.*

| Step | Description |
|---|--|
| 1. Set the averaging BW/AVG [Average] | Press the BW/AVG hard key. Press the Average soft key. |
| 2. Enter number of averaging to set | Use the numeric keys and input a number between 1 and 100. When the averaging reaches to the number set here, a new measurement value replaces the earliest measurement value in sequence. |
| 3. [Enter] or ENTER | Press the Enter soft key or the ENTER hard key. |

Setting Sweep Mode



This hot key is used to set the sweep parameters. The user input window must be inactive first to get the Sweep hot key function other than the number input.

- n **SWEEP MODE:** Sets the sweep method. Toggle between **Continue** and **Single**.

| Step | Description |
|--|---|
| 1. Set the sweep mode SWEEP [Sweep Mode] | Press the SWEEP hot key. Press the Sweep Mode soft key. Toggle between Continue and Single . |

Setting Trigger Source



This hot key is used to select the trigger source among **Internal**, **External**, and **GPS**. The user input window must be inactive first to get the Trigger hot key function other than the number input.

Setting External Clock

To enhance the reliability of modulation analysis measurements the JD740A series must be synchronized with the Base Station. When an external clock is not supplied, the JD740A series works with a built-in internal high-accuracy time base. In this case, some measurement results may exhibit inaccurate values. Therefore, it is highly recommended to use the same reference clock as signal source. Trigger mode can be changed by using the **TRIGGER** hot key.

EXTERNAL CLOCK OPERATING STANDARDS

| Clock | Type | Reference | Port | Switching Standard |
|--------------------|----------|--------------------|---------------|--|
| External Reference | Internal | Internal 10 MHz | | Default |
| | External | External Ref Clock | Ext Ref (SMA) | Manual switching (Input signal level >-3 dBm) |
| | GPS | GPS Clock | GPS (SMA) | Automatic switching (GPS signal received) |
| Trigger | Internal | Internal Trigger | | Default |
| | External | External Trigger | Trigger (SMA) | Manual switching |
| | GPS | GPS | GPS (SMA) | Manual switching |

CONNECTION

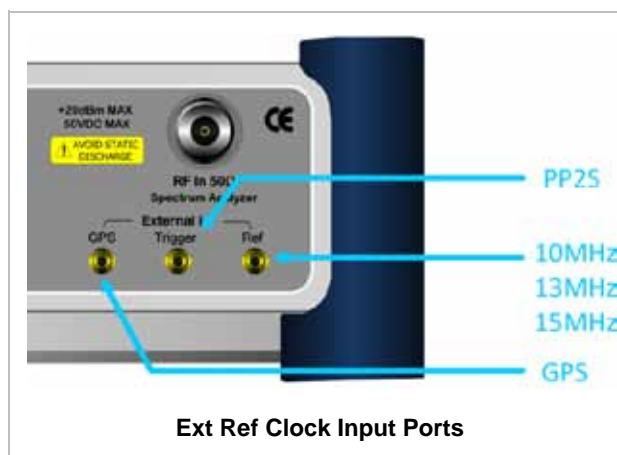

ENABLING EXTERNAL REFERENCE

| Step | Description |
|---|--|
| 1. Connect an external reference | Connect one of the external references or a GPS antenna to the JD740A series. |
| 2. Change reference clock SYSTEM [Frequency Reference] [External 10 MHz], [External 13 MHz], [External 15 MHz] or [GPS] | Press the SYSTEM hot key. Press the Frequency Reference soft key to select one of the external reference clocks or GPS. Press one of the soft keys to choose among External 10 MHz , External 13 MHz , External 15 MHz , and GPS . |

EXTERNAL REFERENCE INDICATOR INFORMATION

Each indicator tells different locking status according to a connection. When a GPS antenna is connected, longitude and latitude information will be displayed on the screen.

| Type | Indicator | Description |
|----------|--|----------------------------------|
| Internal |  (Green) | Locked |
| External |  (Green) | Locked |
| |  (Red) | Unlocked |
| GPS |  (Green) | Locked |
| |  (Yellow) | Locking in progress |
| |  (Gray) | Unable to lock or antenna failed |

CHANNEL POWER

The Channel Power measurement is a common test used in the wireless industry to measure the total transmitted power of a radio within a defined frequency channel. It acquires a number of points representing the input signal in the time domain, transforms this information into the frequency domain using Fast Fourier Transform (FFT) and then calculates the channel power. The effective resolution bandwidth of the frequency domain trace is proportional to the number of points acquired for the FFT.

The channel power measurement identifies the total RF power and power spectral density (PSD) of the signal in the LTE channel bandwidth.

Measurement Procedure

| Step | Description |
|---|--|
| 1. Set the measurement mode MEASURE [RF Analysis] [Channel Power] | Press the MEASURE hot key. Press the RF Analysis soft key. Press the Channel Power soft key. |
| 2. Set the measurement parameters MEASURE SETUP [Bandwidth] [1.4 MHz], [3 MHz], [5 MHz], [10 MHz], [15 MHz], or [20 MHz] | Press the MEASURE SETUP hot key. Press the Bandwidth soft key. Press one of the soft keys to select. |

LTE - FDD Channel Power Measurement Procedure

MEASURE SETUP



- n **BANDWIDTH:** Selects the nominal channel bandwidth to be measured among **1.4 MHz, 3 MHz, 5 MHz, 10 MHz, 15 MHz, and 20 MHz.**

Setting Limit

LIMIT



This hot key is used to set the threshold value for the limit line on the display screen. It turns on or off the limit or band limit settings of the measurement for pass/fail indication. The user input window must be inactive first to get the Limit hot key function other than the number input.

| Step | Description |
|---|--|
| 1. Select the limit LIMIT [RF Test Limits] [Channel Power] [Test Limits] <On> or <Off> [High Limit] Enter a value [dBm] or ENTER [Low Limit] Enter a value | Press the LIMIT hot key. Press the RF Test Limits soft key. Press the Channel Power soft key. Press the Test Limits soft key to toggle between On and Off and select one. Press the High Limit soft key to set the upper limit of the Pass/Fail criteria. Use the numeric keys to input value. Press the unit soft key or the ENTER hard key. Press the Low Limit soft key to set the lower limit of the Pass/Fail criteria. Use the numeric keys to input value. |

| | |
|--|--|
| [dBm] or ENTER | Press the unit soft key or the ENTER hard key. |
| 2. Enable beep LIMIT [Beep] <On> or <Off> | Press the LIMIT hot key. Press the Beep soft key to toggle between On and Off and select one. This will make audible alarm if the measurement result goes beyond the limit. |

- n **TEST LIMITS:** Enables or disables Pass/Fail results on the display screen. Toggle the **Test Limits** soft key to set it to **On** or **Off**.
- n **HIGH LIMIT:** Sets the upper limit of the Pass/Fail criteria. Use the numeric keys to enter a threshold or limit value and press the **dBm** unit soft key or the **ENTER** hard key to complete the input.
- n **LOW LIMIT:** Sets the lower limit of the Pass/Fail criteria. Use the numeric keys to enter a threshold or limit value and press the **dBm** unit soft key or the **ENTER** hard key to complete the input.

Measurement Example

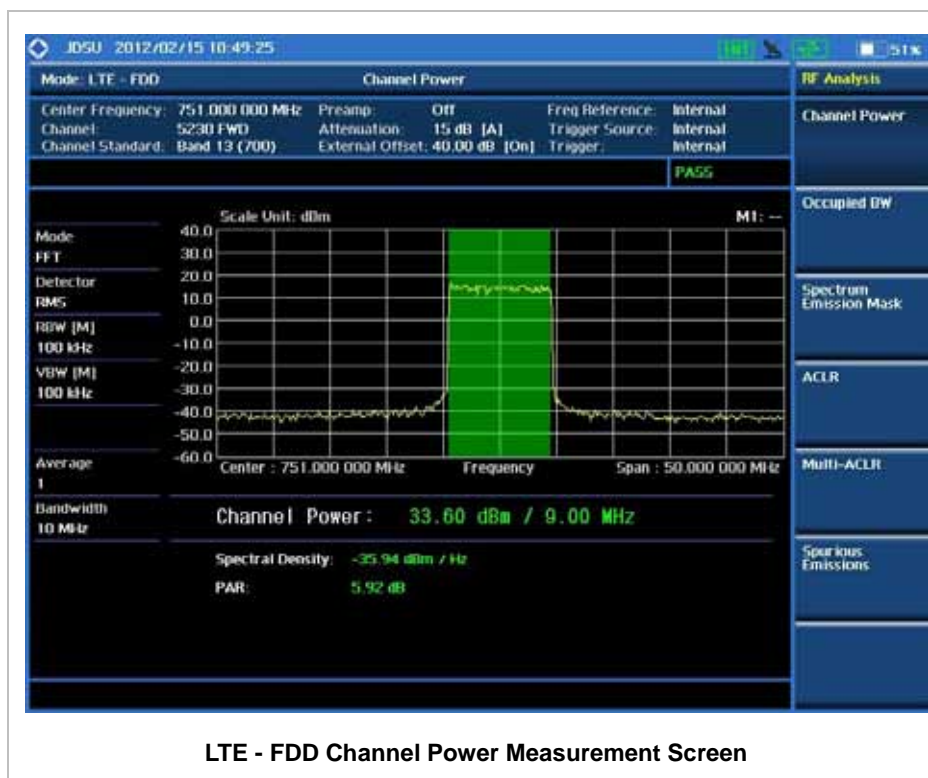

OCCUPIED BANDWIDTH

The Occupied Bandwidth measures the spectrum shape of the carrier. It is defined as the bandwidth which includes 99% of the transmitted power among total transmitted power.

Measurement Procedure

| Step | Description |
|---|--|
| 1. Set the measurement mode MEASURE [RF Analysis] [Occupied BW] | Press the MEASURE hot key. Press the RF Analysis soft key. Press the Occupied BW soft key. |
| 2. Set the measurement parameters MEASURE SETUP [Bandwidth] [1.4 MHz], [3 MHz], [5 MHz], [10 MHz], [15 MHz], or [20 MHz] | Press the MEASURE SETUP hot key. Press the Bandwidth soft key. Press one of the soft keys to select. |

LTE - FDD Occupied BW Measurement Procedure

MEASURE SETUP



- BANDWIDTH:** Selects the nominal channel bandwidth to be measured among **1.4 MHz**, **3 MHz**, **5 MHz**, **10 MHz**, **15 MHz**, and **20 MHz**.

Setting Limit

LIMIT



This hot key is used to set the threshold value for the limit line on the display screen. It turns on or off the limit or band limit settings of the measurement for pass/fail indication. The user input window must be inactive first to get the Limit hot key function other than the number input.

| Step | Description |
|--|--|
| 1. Select the limit LIMIT [RF Test Limits] [Occupied BW] | Press the LIMIT hot key. Press the RF Test Limits soft key. Press the Occupied BW soft key. |

| | |
|---|--|
| <p>[Test Limit] <On> or <Off></p> <p>[High Limit] Enter a value [MHz], [kHz], or [Hz]</p> | <p>Press the Test Limit soft key to toggle between On and Off and select one.</p> <p>Press the High Limit soft key to set the upper limit of the Pass/Fail criteria. Use the numeric keys to input value. Press the unit soft key to select.</p> |
| <p>2. Enable beep</p> <p>LIMIT</p> <p>[Beep] <On> or <Off></p> | <p>Press the LIMIT hot key.</p> <p>Press the Beep soft key to toggle between On and Off and select one. This will make audible alarm if the measurement result goes beyond the limit.</p> |

- n **TEST LIMIT:** Enables or disables Pass/Fail results on the display screen. Toggle the **Test Limit** soft key to set it to **On** or **Off**.
- n **HIGH LIMIT:** Sets the upper limit of the Pass/Fail criteria. Use the numeric keys to enter a threshold or limit value and press one of the unit soft keys to complete the input.

Measurement Example

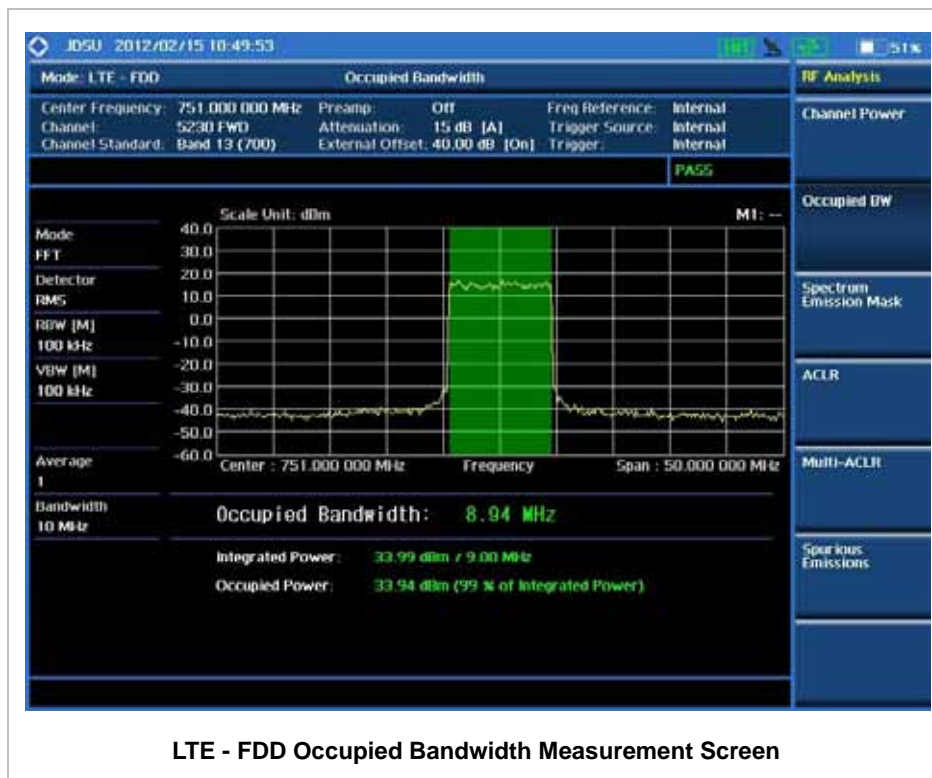

SPECTRUM EMISSION MASK (SEM)

The Spectrum Emission Mask (SEM) measurement compares the total power level within the defined carrier bandwidth and the given offset channels according to the standards.

Measurement Procedure

| Step | Description |
|--|---|
| 1. Set the measurement mode MEASURE [RF Analysis] [Spectrum Emission Mask] | Press the MEASURE hot key. Press the RF Analysis soft key. Press the Spectrum Emission Mask soft key. |
| 2. Set the measurement parameters MEASURE SETUP [Bandwidth] [1.4 MHz], [3 MHz], [5 MHz], [10 MHz], [15 MHz], or [20 MHz] [Mask Type] [Wide Area BS Category A], [Wide Area BS Category B], [Local Area BS], or [Home BS] | Press the MEASURE SETUP hot key. Press the Bandwidth soft key. Press one of the soft keys to select. Press the Mask Type soft key. Press one of the soft keys to select. |

LTE - FDD Spectrum Emission Mask Measurement Procedure

MEASURE SETUP



- n **BANDWIDTH:** Selects the nominal channel bandwidth to be measured among **1.4 MHz, 3 MHz, 5 MHz, 10 MHz, 15 MHz, and 20 MHz.**
- n **MASK TYPE:** Selects the mask type among **Wide Area BS Category A, Wide Area BS Category B, Local Area BS, and Home BS.**

Setting Limit

LIMIT



This hot key is used to set the threshold value for the limit line on the display screen. It turns on or off the limit or band limit settings of the measurement for pass/fail indication. The user input window must be inactive first to get the Limit hot key function other than the number input.

| Step | Description |
|---|--|
| 1. Select the limit LIMIT [RF Test Limits] [Spectrum Emission Mask] [Test Limit] <On> or <Off> | Press the LIMIT hot key. Press the RF Test Limits soft key. Press the Spectrum Emission Mask soft key. Press the Test Limit soft key to toggle between On and Off and select one. |
| 2. Enable beep LIMIT [Beep] <On> or <Off> | Press the LIMIT hot key. Press the Beep soft key to toggle between On and Off and select one. This will make audible alarm if the measurement result goes beyond the limit. |

- n **TEST LIMIT:** Enables or disables Pass/Fail results on the display screen. Toggle the **Test Limit** soft key to set it to **On** or **Off**.

Measurement Example

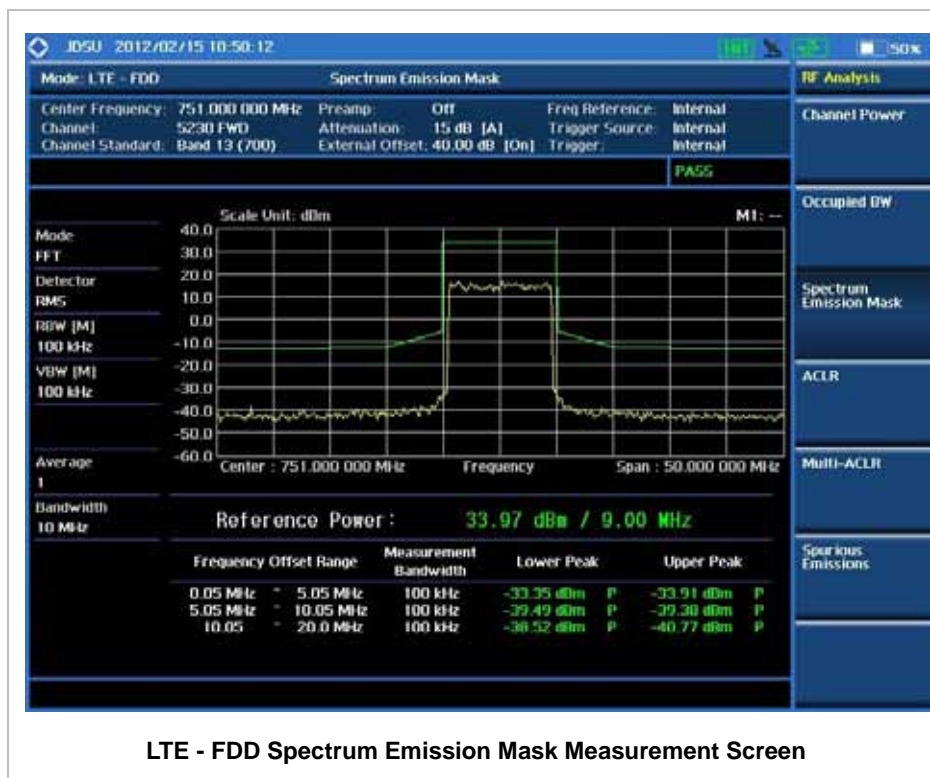

LTE - FDD Spectrum Emission Mask Measurement Screen

ACLR

The Adjacent Channel Leakage power Ratio (ACLR) measures the amount of interference or power in an adjacent frequency channel according to the standards.

Measurement Procedure

| Step | Description |
|---|--|
| 1. Set the measurement mode MEASURE [RF Analysis] [ACLR] | Press the MEASURE hot key. Press the RF Analysis soft key. Press the ACLR soft key. |
| 2. Set the measurement parameters MEASURE SETUP [Bandwidth] [1.4 MHz], [3 MHz], [5 MHz], [10 MHz], [15 MHz], or [20 MHz] | Press the MEASURE SETUP hot key. Press the Bandwidth soft key. Press one of the soft keys to select. |

LTE - FDD ACLR Measurement Procedure

MEASURE SETUP



- n **BANDWIDTH:** Selects the nominal channel bandwidth to be measured among **1.4 MHz**, **3 MHz**, **5 MHz**, **10 MHz**, **15 MHz**, and **20 MHz**.

Setting Limit

LIMIT



This hot key is used to set the threshold value for the limit line on the display screen. It turns on or off the limit or band limit settings of the measurement for pass/fail indication. The user input window must be inactive first to get the Limit hot key function other than the number input.

| Step | Description |
|---|---|
| 1. Select the limit LIMIT [RF Test Limits] [ACLR] [Test Limit] | Press the LIMIT hot key. Press the RF Test Limits soft key. Press the ACLR soft key. Press the Test Limit soft key to toggle between On and |

| | |
|---|--|
| <On> or <Off> | Off and select one. |
| 2. Enable beep LIMIT [Beep] <On> or <Off> | Press the LIMIT hot key. Press the Beep soft key to toggle between On and Off and select one. This will make audible alarm if the measurement result goes beyond the limit. |

- n **TEST LIMIT:** Enables or disables Pass/Fail results on the display screen. Toggle the **Test Limit** soft key to set it to **On** or **Off**.

Measurement Example



LTE - FDD ACLR Measurement Screen

MULTI-ACLR

The Multi-ACLR measurement is used to perform multi-channel ACLR measurements with as many channels as possible. It helps the user to measure ACLR in multi-channel transmitting Base Station environment.

Measurement Procedure

| Step | Description |
|--|--|
| <p>1. Set the measurement mode</p> <p>MEASURE</p> <p> [RF Analysis]</p> <p> [Multi-ACLR]</p> | <p>Press the MEASURE hot key.</p> <p>Press the RF Analysis soft key.</p> <p>Press the Multi-ACLR soft key.</p> |
| <p>2. Set the measurement parameters</p> <p>MEASURE SETUP</p> <p> [Unit]</p> <p> <Freq> or <Channel></p> <p> </p> <p><u>When Freq is selected:</u></p> <p> [Lowest Frequency]</p> <p> Enter a value</p> <p> [GHz], [MHz], [kHz], or [Hz]</p> <p> [Highest Frequency]</p> <p> Enter a value</p> <p> [GHz], [MHz], [kHz], or [Hz]</p> <p> </p> <p><u>When Channel is selected:</u></p> <p> [Channel Standard]</p> <p> Select a channel standard</p> <p> </p> <p> [Select] or ENTER</p> <p> [Lowest Channel]</p> <p> Enter a value</p> <p> [Forward]</p> <p> [Highest Channel]</p> <p> Enter a value</p> <p> [Forward]</p> <p> </p> <p> [Bandwidth]</p> <p> [1.4 MHz], [3 MHz], [5 MHz],</p> <p> [10 MHz], [15 MHz], or [20 MHz]</p> | <p>Press the MEASURE SETUP hot key.</p> <p>Press the Unit soft key. Toggle this key between Freq and Channel. A set of Freq/Dist screen menu changes accordingly.</p> <p> </p> <p>Press the Lowest Frequency soft key.</p> <p>Use the numeric keys to input value.</p> <p>Press one of the unit soft keys to select.</p> <p>Press the Highest Frequency soft key.</p> <p>Use the numeric keys to input value.</p> <p>Press one of the unit soft keys to select.</p> <p> </p> <p>Press the Channel Standard soft key. If this channel standard shows its default setting Band Global, go set the channels directly.</p> <p>Press the arrow keys, rotate the knob, or press the Page Up and Page Down soft keys to highlight a frequency band to select.</p> <p>Press the Select soft key or the ENTER hard key.</p> <p>Press the Lowest Channel soft key.</p> <p>Use the numeric keys to input value.</p> <p>Press the Forward soft key.</p> <p>Press the Highest Channel soft key.</p> <p>Use the numeric keys to input value.</p> <p>Press the Forward soft key.</p> <p> </p> <p>Press the Bandwidth soft key.</p> <p>Press one of the soft keys to select.</p> |

LTE - FDD Multi-ACLR Measurement Procedure

MEASURE SETUP



- n **UNIT:** Determines the way how to set the frequency band either with standard band or custom frequency band. Toggling this key between **Freq** and **Channel** changes a set of Freq/Dist screen menu automatically.
- n **LOWEST FREQUENCY:** Sets the center frequency of the far left end on the display. Use the numeric keys to enter a value and press one of the unit soft keys to complete the input.
- n **HIGHEST FREQUENCY:** Sets the center frequency of the far right end on the display. Use the numeric keys to enter a value and press one of the unit soft keys to complete the input.
- n **LOWEST CHANNEL:** Sets the channel number of the far left end on the display.
- n **HIGHEST CHANNEL:** Sets the channel number of the far right end on the display.
- n **CHANNEL STANDARD:** When the channel standard is selected from the list, the center frequency information on the display screen will be mapped accordingly to the selected channel standard. The channel standards available in the instrument are listed in the Appendix C – Band, Frequency & Channel Standard.
- n **BANDWIDTH:** Selects the nominal channel bandwidth to be measured among **1.4 MHz**, **3 MHz**, **5 MHz**, **10 MHz**, **15 MHz**, and **20 MHz**.

Setting Limit



This hot key is used to set the threshold value for the limit line on the display screen. It turns on or off the limit or band limit settings of the measurement for pass/fail indication. The user input window must be inactive first to get the Limit hot key function other than the number input.

| Step | Description |
|--|--|
| 1. Select the limit LIMIT [RF Test Limits] [Multi-ACLR] [Test Limit] <On> or <Off> | Press the LIMIT hot key. Press the RF Test Limits soft key. Press the Multi-ACLR soft key. Press the Test Limit soft key to toggle between On and Off and select one. |
| 2. Enable beep LIMIT [Beep] <On> or <Off> | Press the LIMIT hot key. Press the Beep soft key to toggle between On and Off and select one. This will make audible alarm if the measurement result goes beyond the limit. |

- n **TEST LIMIT:** Enables or disables Pass/Fail results on the display screen. Toggle the **Test Limit**

soft key to set it to **On** or **Off**.

Measurement Example

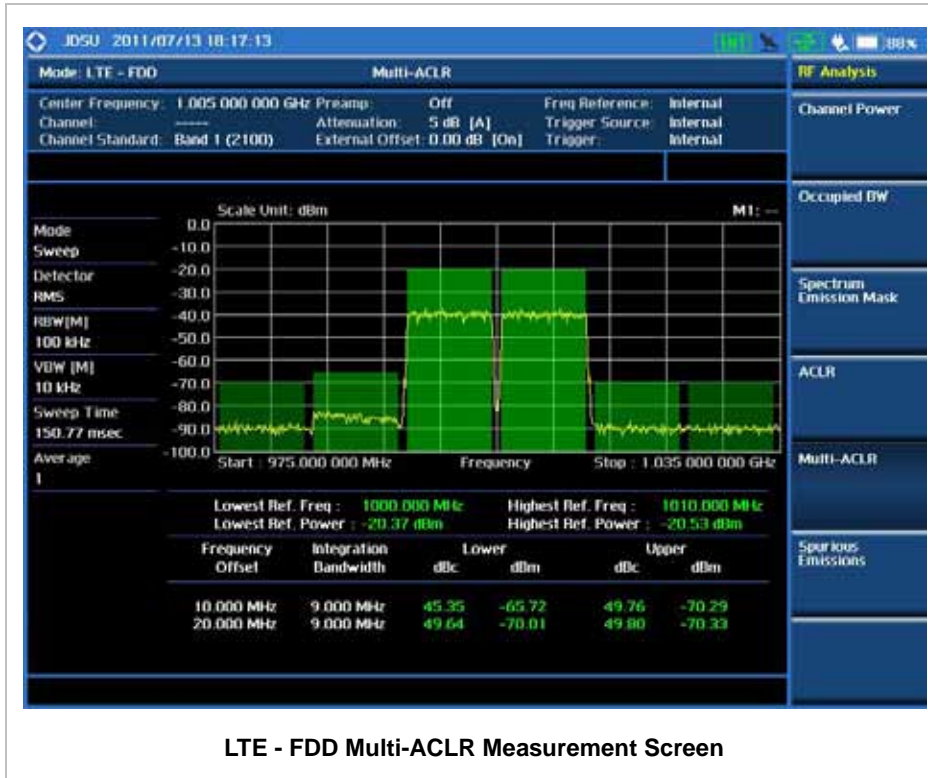

SPURIOUS EMISSIONS

Out-of-band emissions are unwanted emissions immediately outside the channel bandwidth resulting from the modulation process and non-linearity in the transmitter but excluding spurious emissions. The Spurious Emissions measurement is to identify and determine the power level of out-of-band spurious emission within the necessary channel bandwidth and modulated signal measured at the RF port of the Base Station.

Measurement Procedure

| Step | Description |
|---|---|
| 1. Set the measurement mode MEASURE [RF Analysis] | Press the MEASURE hot key. Press the RF Analysis soft key. |

| | |
|--|---|
| <p>[Spurious Emissions]</p> | <p>Press the Spurious Emissions soft key.</p> |
| <p>2. Set the measurement parameters</p> <p>MEASURE SETUP</p> <p>[Range Table]</p> <p>[Range] Enter a value</p> <p>[Enter]</p> <p>[Start Frequency] Enter a value</p> <p>[GHz], [MHz], [kHz], or [Hz]</p> <p>[Stop Frequency] Enter a value</p> <p>[GHz], [MHz], [kHz], or [Hz]</p> <p>[Start Limit] Enter a value</p> <p>[dBm]</p> <p>[Stop Limit] Enter a value</p> <p>[dBm]</p> <p>[Attenuation] Enter a value</p> <p>[dB] or ENTER</p> <p>[RBW] Enter a value</p> <p>[GHz], [MHz], [kHz], or [Hz]</p> <p>[VBW] Enter a value</p> <p>[GHz], [MHz], [kHz], or [Hz]</p> <p>[Measure Type] <Examine> or <Full></p> <p>[Average] Enter a value</p> <p>[Enter] or ENTER</p> | <p>Press the MEASURE SETUP hot key.</p> <p>Press the Range Table soft key.</p> <p>Press the Range soft key.</p> <p>Use the numeric keys to select the range number.</p> <p>Press the Enter soft key.</p> <p>Press the Start Frequency soft key.</p> <p>Use the numeric keys.</p> <p>Press one of the unit soft keys to select.</p> <p>Press the Stop Frequency soft key.</p> <p>Use the numeric keys.</p> <p>Press one of the unit soft keys to select.</p> <p>Press the Start Limit soft key.</p> <p>Use the numeric keys.</p> <p>Press the unit soft key to complete the input.</p> <p>Press the Stop Limit soft key.</p> <p>Use the numeric keys.</p> <p>Press the unit soft key to complete the input.</p> <p>Press the Attenuation soft key.</p> <p>Use the numeric keys to enter input value in the multiple of 5.</p> <p>Press the dB unit soft key or the ENTER hard key.</p> <p>Press the RBW soft key.</p> <p>Use the numeric keys.</p> <p>Press one of the unit soft keys to select.</p> <p>Press the VBW soft key.</p> <p>Use the numeric keys.</p> <p>Press one of the unit soft keys to select.</p> <p>Press the Measure Type soft key to toggle between Examine and Full.</p> <p>Press the Average soft key.</p> <p>Use the numeric keys to enter a value.</p> <p>Press the Enter soft key or the ENTER hard key.</p> |

LTE - FDD Spurious Emissions Measurement Procedure

MEASURE SETUP



Sets the measurement parameters including range table and measurement type. The measurement settings can be saved and recalled as a file. Also, JDViewer, PC application software allows the user

to set the parameters in the user's computer to import into the instrument.

- n **RANGE TABLE:** Sets the range table parameters.
 - Y **RANGE:** Adds a new range number or selects one of the existing range numbers to show or hide the particular frequency range in the range table at the bottom of the screen. Use the numeric keys to enter a range number and press the **Enter** soft key to complete the input. Each time the **Range** soft key is press, it toggles between **On** and **Off**.
 - Y **START FREQUENCY:** Sets or changes the start frequency value to be measured for the selected range number in the Range menu. Use the numeric keys to enter a value and press one of the unit soft keys.
 - Y **STOP FREQUENCY:** Sets or changes the stop frequency value to be measured for the selected range number in the Range menu. Use the numeric keys to enter a value and press one of the unit soft keys.
 - Y **START LIMIT:** Sets the start value of the limit line for the displayed range.
 - Y **STOP LIMIT:** Sets the stop value of the limit line for the displayed range.
 - Y **ATTENUATION:** Sets the attenuation value in the multiple of 5.
 - Y **RBW:** Sets the resolution bandwidth for the selected range number in the Range menu.
 - Y **VBW:** Sets the video bandwidth for the selected range number in the Range menu.
- n **MEASURE TYPE:** Sets the measurement type to **Examine** or **Full**. Toggle between **Examine** and **Full**. Examine mode will show selected range only. The instrument will automatically switch and show all ranges when Full is selected.
- n **RANGE:** Selects the range number to be displayed on the screen. This key is activated only when the **Measure Type** is set to **Examine** mode. Use the numeric keys to select one of the existing range numbers that are configured in the Range Table menu. Pressing the **Enter** soft key completes the input and changes the display.
- n **AVERAGE:** Sets the frequency the number of trace to be averaged.

Setting Limit



This hot key is used to set the threshold value for the limit line on the display screen. It turns on or off the limit or band limit settings of the measurement for pass/fail indication. The user input window must be inactive first to get the Limit hot key function other than the number input.

| Step | Description |
|--|--|
| 1. Select the limit LIMIT [RF Test Limits] [Spurious Emissions] [Test Limit] <On> or <Off> | Press the LIMIT hot key. Press the RF Test Limits soft key. Press the Spurious Emissions soft key. Press the Test Limit soft key to toggle between On and Off and select one. |
| 2. Enable beep LIMIT [Beep] <On> or <Off> | Press the LIMIT hot key. Press the Beep soft key to toggle between On and Off and select one. This will make audible alarm if the measurement result goes beyond the limit. |

- n **TEST LIMIT:** Enables or disables Pass/Fail results on the display screen. Toggle the **Test Limit** soft key to set it to **On** or **Off**.

Measurement Example

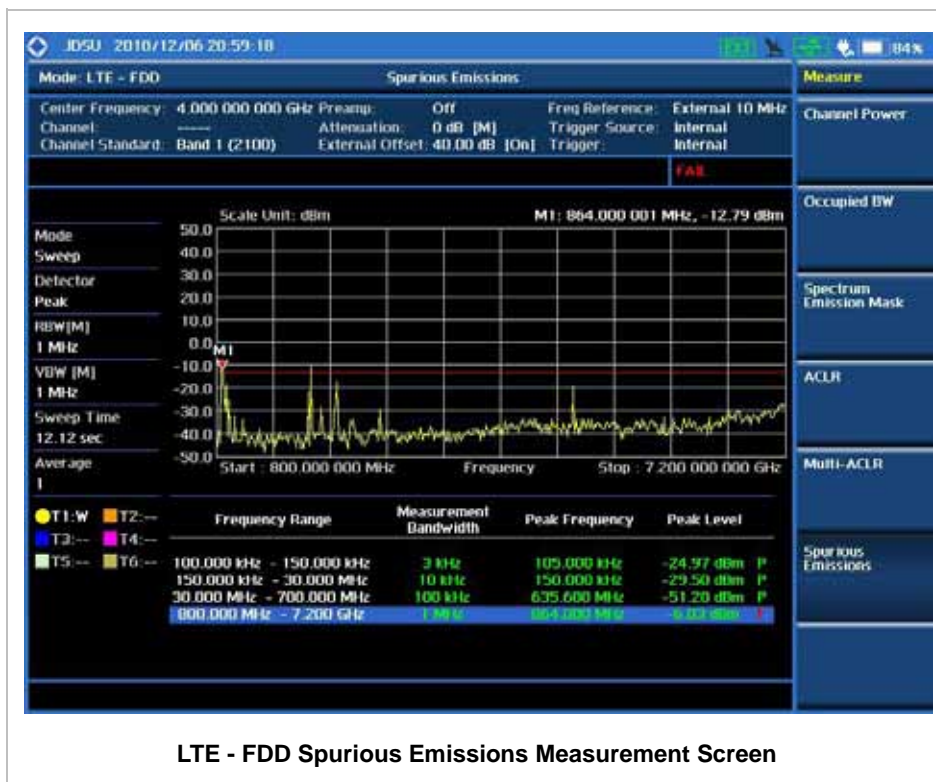

LTE - FDD Spurious Emissions Measurement Screen

POWER VS TIME (FRAME) MEASUREMENT

The Power vs Time (Frame) in LTE - FDD Signal Analyzer measures the modulation envelope in the time domain, showing the power of each time slot in an LTE signal.

Setting Mode

| Step | Description |
|---|---|
| 1. Connect the cable | Connect a cable directly or indirectly as shown in the section Connecting a Cable on page 8 of this chapter. |
| 2. Select the mode MODE [Signal Analyzer] [LTE - FDD] [Power vs Time (Frame)] | Press the MODE hard key. Press the Signal Analyzer soft key. Press the LTE - FDD soft key. Press the Power vs Time (Frame) soft key. |

Setting Frequency

| Step | Description |
|---|--|
| 1. Set the frequency FREQ/DIST [Unit] <Freq> or <Channel> <i>When Freq is selected:</i> [Center Frequency] Enter a value [GHz], [MHz], [kHz], or [Hz] <i>When Channel is selected:</i> [Channel Standard] Select a channel standard [Select] or ENTER [Channel Number] Enter a value [Forward] | Press the FREQ/DIST hard key. Press the Unit soft key. Toggle this key between Freq and Channel . A set of Freq/Dist screen menu changes accordingly. Press the Center Frequency soft key. Use the numeric keys, the rotary knob, or the arrow keys. When using the numeric keys, the input is completed by selecting one of the unit soft keys. Press the Channel Standard soft key. If this channel standard shows its default setting Band Global, go set the channel number directly. Press the arrow keys, rotate the knob, or press the Page Up and Page Down soft keys to highlight a frequency band to select. Press the Select soft key or the ENTER hard key. Press the Channel Number soft key. Use the numeric keys to input value and press the Forward soft key to complete the input. The instrument automatically |

| | |
|--|---|
| | displays its corresponding center frequency value for the channel number. |
|--|---|

FREQ/DIST 

- n **UNIT:** Determines the way how to set the frequency band either with standard band or custom frequency band. Toggling this key between **Freq** and **Channel** changes a set of Freq/Dist screen menu automatically. When the **Channel** is selected, the instrument sets the **Channel Standard** setting to **Band Global** as default so that the user can set the **Channel Number** directly without choosing a standard channel band from the list.
- n **CENTER FREQUENCY:** Changes the center frequency setting. Use the rotary knob or the arrow keys. Or use the numeric keys to input a certain value and press one of the unit soft keys to complete the input.
- n **FREQUENCY STEP:** Defines the amount of frequency to be increased or decreased when using the rotary knob or the arrow keys to change the **Center Frequency**. This frequency step size can be entered by using numeric keys and the unit soft keys.
- n **CHANNEL NUMBER:** Enters a channel number. The instrument automatically displays its corresponding center frequency value for the channel number.
- n **CHANNEL STEP:** Defines the amount of channel to be increased or decreased when using the rotary knob or the arrow keys to change the **Channel Number**. This channel step size can be entered by using numeric keys and the **Enter** soft key.
- n **CHANNEL STANDARD:** When the channel standard is selected from the list, the center frequency information on the display screen will be mapped accordingly to the selected channel standard. The channel standards available in the instrument are listed in the Appendix C – Band, Frequency & Channel Standard.

Setting Amplitude

| Step | Description |
|---|--|
| 1. Set the reference/attenuation level AMP/SCALE [Auto Scale] or | Press the AMP/SCALE hard key. Press the Auto Scale soft key to automatically set optimum levels of reference and attenuation. |

| | |
|--|---|
| <p>[Reference Level] Enter a reference level value</p> | <p>Press the Reference Level soft key to set manually. Use the numeric keys or the rotary knob that changes in a 10 dB step.</p> |
| <p>[dBm] or ENTER</p> | <p>Press the dBm soft key or the ENTER hard key.</p> |
| <p>[Attenuation] <Manual> Enter an attenuation value</p> | <p>Press the Attenuation soft key. The Auto mode is set by default. This key toggles between the Auto and Manual. Press the Attenuation soft key to highlight the Manual mode and change the attenuation value to optimize S/N. Use the numeric keys or the rotary knob that changes in a 5 dB step. The attenuation setting range is 0 to 50 dB.</p> |

AMP/SCALE



- n **AUTO SCALE:** The instrument can automatically set the scale to the minimum and maximum values on the Y-axis of the graph for optimum display of the traces measured. Each time the **Auto Scale** is selected, the top and bottom scales are set to the minimum and maximum values with margin on the Y-axis of the display screen.
- n **REFERENCE LEVEL:** Sets the maximum Y-axis range.
- n **ATTENUATION**
 - Y **AUTO:** Input attenuator's value is automatically set depending on the reference level. This is the default operation mode, so it is recommended to use this mode unless a special measurement condition is needed.
 - Y **MANUAL:** Sets the attenuator's value for the **Spectrum Analyzer RF In 50 Ω** port.
- n **PREAMP:** Turns on or off the internal pre-amplifier. Preamp results in a correction being applied to compensate for the gain of the preamp so that amplitude readings show the value at the input connector. This soft key toggles between the **On** and **Off**. When it is set to On, the allowable attenuation input range is from 0 dB to 10 dB in a multiple of 5. If the attenuation value is manually set greater than 10 dB, the instrument will automatically turn off the pre-amplifier to display low level signal properly on the screen.
- n **EXTERNAL OFFSET:** Sets an external offset value. An offset consists of a cable loss and a user offset and the measurement result shows the value reflecting both offset values. When the external offset value is set at 40 dB in the Spectrum mode, the measurement result compensates 40 dB at both the Spectrum Analyzer and Signal Analyzer modes.

Setting Sweep Mode

SWEEP

This hot key is used to set the sweep parameters. The user input window must be inactive first to get the Sweep hot key function other than the number input.

- n **SWEEP MODE:** Sets the sweep method. Toggle between **Continue** and **Single**.

| Step | Description |
|---|---|
| 1. Set the sweep mode SWEEP [Sweep Mode] | Press the SWEEP hot key. Press the Sweep Mode soft key. Toggle between Continue and Single . |

Setting Trigger Source**TRIGGER**

This hot key is used to select the trigger source among **Internal**, **External**, and **GPS**. The user input window must be inactive first to get the Trigger hot key function other than the number input.

Setting External Clock

To enhance the reliability of modulation analysis measurements the JD740A series must be synchronized with the Base Station. When an external clock is not supplied, the JD740A series works with a built-in internal high-accuracy time base. In this case, some measurement results may exhibit inaccurate values. Therefore, it is highly recommended to use the same reference clock as signal source. Trigger mode can be changed by using the **TRIGGER** hot key.

EXTERNAL CLOCK OPERATING STANDARDS

| Clock | Type | Reference | Port | Switching Standard |
|--------------------|----------|--------------------|---------------|--|
| External Reference | Internal | Internal 10 MHz | | Default |
| | External | External Ref Clock | Ext Ref (SMA) | Manual switching (Input signal level >-3 dBm) |
| | GPS | GPS Clock | GPS (SMA) | Automatic switching (GPS signal received) |
| Trigger | Internal | Internal Trigger | | Default |
| | External | External Trigger | Trigger (SMA) | Manual switching |
| | GPS | GPS | GPS (SMA) | Manual switching |

CONNECTION

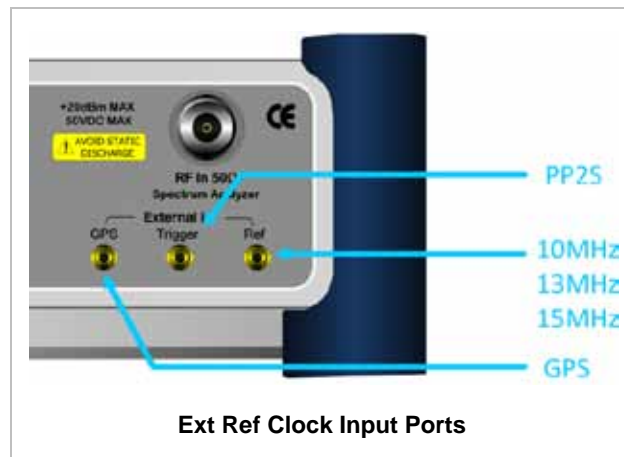

ENABLING EXTERNAL REFERENCE

| Step | Description |
|---|--|
| 1. Connect an external reference | Connect one of the external references or a GPS antenna to the JD740A series. |
| 2. Change reference clock SYSTEM [Frequency Reference] [External 10 MHz], [External 13 MHz], [External 15 MHz] or [GPS] | Press the SYSTEM hot key. Press the Frequency Reference soft key to select one of the external reference clocks or GPS. Press one of the soft keys to choose among External 10 MHz , External 13 MHz , External 15 MHz , and GPS . |

EXTERNAL REFERENCE INDICATOR INFORMATION

Each indicator tells different locking status according to a connection. When a GPS antenna is connected, longitude and latitude information will be displayed on the screen.

| Type | Indicator | Description |
|----------|-----------|----------------------------------|
| Internal | (Green) | Locked |
| External | (Green) | Locked |
| | (Red) | Unlocked |
| GPS | (Green) | Locked |
| | (Yellow) | Locking in progress |
| | (Gray) | Unable to lock or antenna failed |

Measurement Procedure

| Step | Description |
|---|---|
| 1. Set the measurement mode MEASURE [Power vs Time (Frame)] | Press the MEASURE hot key. Press the Power vs Time (Frame) soft key. |
| 2. Set the measurement parameters MEASURE SETUP [Bandwidth] [1.4 MHz], [3 MHz], [5 MHz], [10 MHz], [15 MHz], or [20 MHz] [Subframe No] Enter a value [Enter] [Cell ID] <Auto> or <Manual> Enter a value [Enter] | Press the MEASURE SETUP hot key. Press the Bandwidth soft key. Press one of the soft keys to select. Press the Subframe No soft key. Use the numeric keys to input value. Press the Enter soft key to complete the input. Press the Cell ID soft key. Toggle between Auto and Manual to select one. Use the numeric keys to set the Cell ID manually. Press the Enter soft key. |

LTE - FDD Power vs Time (Frame) Measurement Procedure

MEASURE SETUP



- n **BANDWIDTH:** Selects the nominal channel bandwidth to be measured among **1.4 MHz, 3 MHz, 5 MHz, 10 MHz, 15 MHz, and 20 MHz.**
- n **SUBFRAME NO:** Sets the subframe number to be measured.
- n **CELL ID:** Enables or disables automatic detection of the Cell ID of the transmitted LTE signal. Manually setting the Cell ID to a specific one can speed up to get synchronization with BTS.
 - Y **AUTO:** Detects the Cell ID automatically.
 - Y **MANUAL:** Sets the Cell ID to a specific one.
- n **MISCELLANEOUS**
 - Y **ANTENNA PORT:** Sets the antenna port number automatically or manually. Each time this soft key is pressed, selection changes among **Auto, 0, and 1.**
 - Y **CYCLIC PREFIX:** Sets the cyclic prefix to **Normal** or **Extended.** For OFDM parameter details by different bandwidth, refer to the table in the Appendix E – Cyclic Prefix Table.

Measurement Example

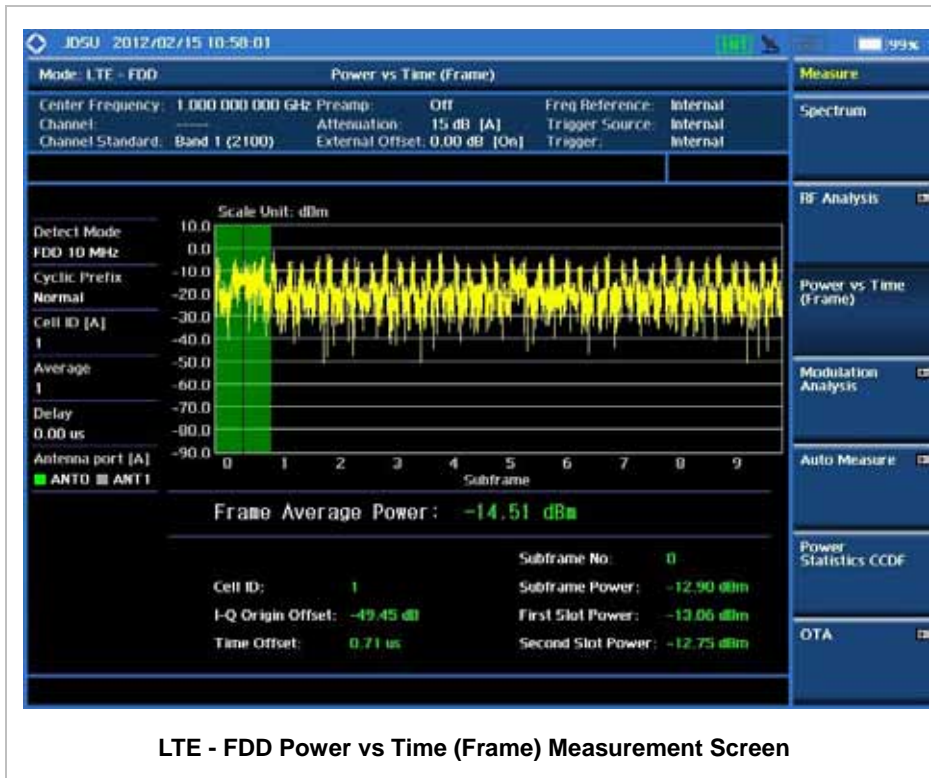

LTE - FDD Power vs Time (Frame) Measurement Screen

MODULATION ANALYSIS MEASUREMENTS

Modulation Analysis in LTE - FDD Signal Analyzer provides single-button measurements for the following essential measurements.

- n Constellation
- n Data Channel
- n Control Channel
- n Subframe
- n Frame
- n Time Alignment Error
- n Data Allocation Map

Setting Mode

| Step | Description |
|---|---|
| 1. Connect the cable | Connect a cable directly or indirectly as shown in the section Connecting a Cable on page 8 of this chapter. |
| 2. Select the mode MODE [Signal Analyzer] [LTE - FDD] [Modulation Analysis] [Constellation], [Data Channel], [Control Channel], [Subframe], [Frame], [Time Alignment Error], or [Data Allocation Map] | Press the MODE hard key. Press the Signal Analyzer soft key. Press the LTE - FDD soft key. Press the Modulation Analysis soft key. Press one of the measurement mode soft keys to select. |

Setting Frequency

| Step | Description |
|--|---|
| 1. Set the frequency FREQ/DIST [Unit] <Freq> or <Channel> | Press the FREQ/DIST hard key. Press the Unit soft key. Toggle this key between Freq and Channel . A set of Freq/Dist screen menu changes accordingly. |
| <i>When Freq is selected:</i> [Center Frequency] Enter a value [GHz], [MHz], [kHz], or [Hz] | Press the Center Frequency soft key. Use the numeric keys, the rotary knob, or the arrow keys. When using the numeric keys, the input is completed by selecting one of the unit soft keys. |
| <i>When Channel is selected:</i> [Channel Standard] Select a channel standard [Select] or ENTER | Press the Channel Standard soft key. If this channel standard shows its default setting Band Global, go set the channel number directly. Press the arrow keys, rotate the knob, or press the Page Up and Page Down soft keys to highlight a frequency band to select. Press the Select soft key or the ENTER hard key. |
| [Channel Number] Enter a value | Press the Channel Number soft key. Use the numeric keys to input value and press the Forward |

| | |
|------------------|--|
| [Forward] | soft key to complete the input. The instrument automatically displays its corresponding center frequency value for the channel number. |
|------------------|--|

FREQ/DIST



- n **UNIT:** Determines the way how to set the frequency band either with standard band or custom frequency band. Toggling this key between **Freq** and **Channel** changes a set of Freq/Dist screen menu automatically. When the **Channel** is selected, the instrument sets the **Channel Standard** setting to **Band Global** as default so that the user can set the **Channel Number** directly without choosing a standard channel band from the list.
- n **CENTER FREQUENCY:** Changes the center frequency setting. Use the rotary knob or the arrow keys. Or use the numeric keys to input a certain value and press one of the unit soft keys to complete the input.
- n **FREQUENCY STEP:** Defines the amount of frequency to be increased or decreased when using the rotary knob or the arrow keys to change the **Center Frequency**. This frequency step size can be entered by using numeric keys and the unit soft keys.
- n **CHANNEL NUMBER:** Enters a channel number. The instrument automatically displays its corresponding center frequency value for the channel number.
- n **CHANNEL STEP:** Defines the amount of channel to be increased or decreased when using the rotary knob or the arrow keys to change the **Channel Number**. This channel step size can be entered by using numeric keys and the **Enter** soft key.
- n **CHANNEL STANDARD:** When the channel standard is selected from the list, the center frequency information on the display screen will be mapped accordingly to the selected channel standard. The channel standards available in the instrument are listed in the Appendix C – Band, Frequency & Channel Standard.

Setting Amplitude

| Step | Description |
|---|--|
| 1. Set the reference/attenuation level AMP/SCALE [Auto Scale] or | Press the AMP/SCALE hard key. Press the Auto Scale soft key to automatically set optimum levels of reference and attenuation. |

| | |
|---|---|
| <p>[Reference Level] Enter a reference level value</p> | <p>Press the Reference Level soft key to set manually. Use the numeric keys or the rotary knob that changes in a 10 dB step.</p> |
| <p>[dBm] or ENTER</p> | <p>Press the dBm soft key or the ENTER hard key.</p> |
| <p>[Attenuation]</p> | <p>Press the Attenuation soft key. The Auto mode is set by default. This key toggles between the Auto and Manual.</p> |
| <p><Manual></p> | <p>Press the Attenuation soft key to highlight the Manual mode and change the attenuation value to optimize S/N.</p> |
| <p>Enter an attenuation value</p> | <p>Use the numeric keys or the rotary knob that changes in a 5 dB step. The attenuation setting range is 0 to 50 dB.</p> |

AMP/SCALE



- n **AUTO SCALE:** The instrument can automatically set the scale to the minimum and maximum values on the Y-axis of the graph for optimum display of the traces measured. Each time the **Auto Scale** is selected, the top and bottom scales are set to the minimum and maximum values with margin on the Y-axis of the display screen.
- n **REFERENCE:** Sets the display of measurement result to relative or absolute value. Toggle between **Abs** for absolute and **Rel** for relative. *This key is not used in the Data Channel mode.*
 - Y **ABS:** The code domain power is measured absolute to channel power.
 - Y **REL:** The code domain power is measured relative to channel power.
- n **REFERENCE LEVEL:** Sets the maximum Y-axis range. *This key is used in the Data Channel mode.*
- n **ATTENUATION**
 - Y **AUTO:** Input attenuator's value is automatically set depending on the reference level. This is the default operation mode, so it is recommended to use this mode unless a special measurement condition is needed.
 - Y **MANUAL:** Sets the attenuator's value for the **Spectrum Analyzer RF In 50 Ω** port.
- n **PREAMP:** Turns on or off the internal pre-amplifier. Preamp results in a correction being applied to compensate for the gain of the preamp so that amplitude readings show the value at the input connector. This soft key toggles between the **On** and **Off**. When it is set to On, the allowable attenuation input range is from 0 dB to 10 dB in a multiple of 5. If the attenuation value is manually set greater than 10 dB, the instrument will automatically turn off the pre-amplifier to display low level signal properly on the screen.
- n **EXTERNAL OFFSET:** Sets an external offset value. An offset consists of a cable loss and a user

offset and the measurement result shows the value reflecting both offset values. When the external offset value is set at 40 dB in the Spectrum mode, the measurement result compensates 40 dB at both the Spectrum Analyzer and Signal Analyzer modes.

Setting Sweep Mode



This hot key is used to set the sweep parameters. The user input window must be inactive first to get the Sweep hot key function other than the number input.

- n **SWEEP MODE:** Sets the sweep method. Toggle between **Continue** and **Single**.

| Step | Description |
|---|---|
| 1. Set the sweep mode SWEEP [Sweep Mode] | Press the SWEEP hot key. Press the Sweep Mode soft key. Toggle between Continue and Single . |

Setting Trigger Source



This hot key is used to select the trigger source among **Internal**, **External**, and **GPS**. The user input window must be inactive first to get the Trigger hot key function other than the number input.

Setting External Clock

To enhance the reliability of modulation analysis measurements the JD740A series must be synchronized with the Base Station. When an external clock is not supplied, the JD740A series works with a built-in internal high-accuracy time base. In this case, some measurement results may exhibit inaccurate values. Therefore, it is highly recommended to use the same reference clock as signal source. Trigger mode can be changed by using the **TRIGGER** hot key.

EXTERNAL CLOCK OPERATING STANDARDS

| Clock | Type | Reference | Port | Switching Standard |
|--------------------|----------|--------------------|---------------|--|
| External Reference | Internal | Internal 10 MHz | | Default |
| | External | External Ref Clock | Ext Ref (SMA) | Manual switching (Input signal level >-3 dBm) |

| | | | | |
|---------|----------|------------------|---------------|--|
| | GPS | GPS Clock | GPS (SMA) | Automatic switching (GPS signal received) |
| Trigger | Internal | Internal Trigger | | Default |
| | External | External Trigger | Trigger (SMA) | Manual switching |
| | GPS | GPS | GPS (SMA) | Manual switching |

CONNECTION

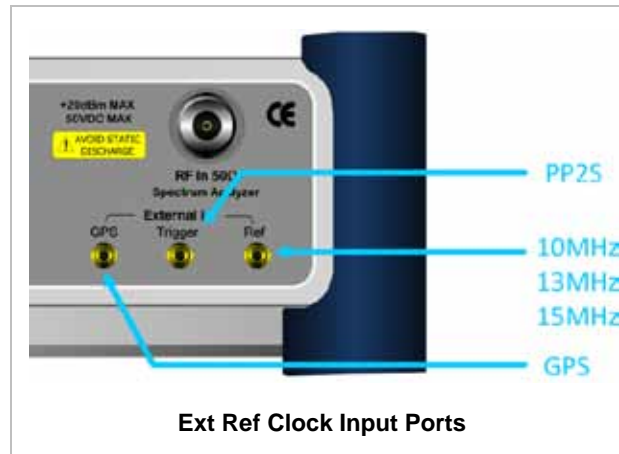

ENABLING EXTERNAL REFERENCE

| Step | Description |
|---|--|
| 1. Connect an external reference | Connect one of the external references or a GPS antenna to the JD740A series. |
| 2. Change reference clock SYSTEM [Frequency Reference] [External 10 MHz], [External 13 MHz], [External 15 MHz] or [GPS] | Press the SYSTEM hot key. Press the Frequency Reference soft key to select one of the external reference clocks or GPS. Press one of the soft keys to choose among External 10 MHz , External 13 MHz , External 15 MHz , and GPS . |

EXTERNAL REFERENCE INDICATOR INFORMATION

Each indicator tells different locking status according to a connection. When a GPS antenna is connected, longitude and latitude information will be displayed on the screen.

| Type | Indicator | Description |
|----------|--|----------------------------------|
| Internal |  (Green) | Locked |
| External |  (Green) | Locked |
| |  (Red) | Unlocked |
| GPS |  (Green) | Locked |
| |  (Yellow) | Locking in progress |
| |  (Gray) | Unable to lock or antenna failed |

CONSTELLATION

The Constellation is used to analyze transmitter modulation performance. The JD740A series displays the constellation diagram with modulation metrics to characterize the performance.

Measurement Procedure

| Step | Description |
|---|---|
| 1. Set the measurement mode MEASURE [Modulation Analysis] [Constellation] | Press the MEASURE hot key. Press the Modulation Analysis soft key. Press the Constellation soft key. |
| 2. Set the measurement parameters MEASURE SETUP [Bandwidth] [1.4 MHz], [3 MHz], [5 MHz], [10 MHz], [15 MHz], or [20 MHz] [Subframe No] Enter a value [Enter] [PHICH Ng] [1/6], [1/2], [1], [2], [E-1/6], [E-1/2], [E-1], or [E-2] [CFI] <Auto> or <Manual> | Press the MEASURE SETUP hot key. Press the Bandwidth soft key. Press one of the soft keys to select. Press the Subframe No soft key. Use the numeric keys to input value. Press the Enter soft key to complete the input. Press the PHICH Ng soft key. Select one of the soft keys to set the number of PHICH groups (Ng). Press the CFI soft key to toggle between Auto and Manual . |

| | |
|---|--|
| Enter a value [Enter] | Use the numeric keys to manually input value. Press the Enter soft key. |
| [Cell ID] <Auto> or <Manual> Enter a value [Enter] | Press the Cell ID soft key. Toggle between Auto and Manual . Use the numeric keys to set the Cell ID manually. Press the Enter soft key. |

LTE - FDD Constellation Measurement Procedure

MEASURE SETUP



- n **BANDWIDTH:** Selects the nominal channel bandwidth to be measured among **1.4 MHz, 3 MHz, 5 MHz, 10 MHz, 15 MHz,** and **20 MHz.**
- n **SUBFRAME NO:** Sets the subframe number to be measured.
- n **CELL ID:** Enables or disables automatic detection of the Cell ID of the transmitted LTE signal. Manually setting the Cell ID to a specific one can speed up to get synchronization with BTS.
 - Y **AUTO:** Detects the Cell ID automatically.
 - Y **MANUAL:** Sets the Cell ID to a specific one.
- n **CFI:** Sets the number of OFDM symbols used for transmission of PDCCHs in a subframe. Toggle this soft key between **Auto** and **Manual**. The set of OFDM symbols that can be used for PDCCH in a subframe is given by **0, 2, 3** or **4** in 1.4 MHz bandwidth and **1, 2,** or **3** in other bandwidths.
- n **PHICH Ng:** Sets the number of PHICH groups (Ng) which is constant in all subframes. Choose the PHICH Ng among **1/6, 1/2, 1, 2, E-1/6, E-1/2, E-1,** or **E-2.**
- n **MISCELLANEOUS**
 - Y **ANTENNA PORT:** Sets the antenna port number automatically or manually. Each time this soft key is pressed, selection changes among **Auto, 0,** and **1.**
 - Y **CYCLIC PREFIX:** Sets the cyclic prefix to **Normal** or **Extended**. For OFDM parameter details by different bandwidth, refer to the table in the Appendix E – Cyclic Prefix Table.
 - Y **PDSCH MODULATION TYPE:** Sets the modulation type in a frame among **Auto, QPSK, 16QAM, 64QAM, E-TM3.3, E-TM3.2, E-TM3.1, E-TM2, E-TM1.2,** and **E-TM1.1.** If two or more modulation types are used in a frame, set the PDSCH Modulation Type to **Auto**. If the PDSCH uses the same modulation type in a frame or in a subframe, set it to specific modulation type to get more accurate EVM.
 - Y **PDSCH THRESHOLD:** Sets the threshold of PDSCH. Use the numeric keys to input value and press the **dB** unit soft key to complete the input.

Setting Limit



This hot key is used to set the threshold value for the limit line on the display screen. It turns on or off the limit or band limit settings of the measurement for pass/fail indication. The user input window must be inactive first to get the Limit hot key function other than the number input.

| Step | Description |
|---|--|
| <p>1. Select the limit</p> <p>LIMIT</p> <p>[Modulation Test Limits]</p> <p> [Frequency Error]</p> <p> [Test Limits]</p> <p> <On> or <Off></p> <p> [High Limit]</p> <p> [Low Limit]</p> <p>[EVM]</p> <p> [PDSCH EVM]</p> <p> [Test Limits]</p> <p> <On> or <Off></p> <p> [High Limit (QPSK)]</p> <p> [High Limit (16QAM)]</p> <p> [High Limit (64QAM)]</p> <p>[Data EVM RMS]</p> <p> [Test Limits]</p> <p> <On> or <Off></p> <p> [High Limit]</p> <p>[Data EVM Peak]</p> <p> [Test Limits]</p> <p> <On> or <Off></p> <p> [High Limit]</p> <p>[Time Error]</p> <p> [Test Limits]</p> <p> <On> or <Off></p> <p> [High Limit]</p> <p> [Low Limit]</p> <p>[IQ Origin Offset]</p> | <p>Press the LIMIT hot key.</p> <p>Press the Modulation Test Limits soft key.</p> <p>Press the Frequency Error soft key.</p> <p>Press the Test Limits soft key. Toggle between On and Off.</p> <p>Use the numeric keys and input a number in ppm.</p> <p>Use the numeric keys and input a number in ppm.</p> <p>Press the EVM soft key.</p> <p>Press the PDSCH EVM soft key.</p> <p>Press the Test Limits soft key. Toggle between On and Off.</p> <p>Press the High Limit (QPSK) soft key to input value.</p> <p>Press the High Limit (16QAM) soft key to input value.</p> <p>Press the High Limit (64QAM) soft key to input value.</p> <p>Press the Data EVM RMS soft key.</p> <p>Press the Test Limits soft key. Toggle between On and Off.</p> <p>Press the High Limit soft key to input value.</p> <p>Press the Data EVM Peak soft key.</p> <p>Press the Test Limits soft key. Toggle between On and Off.</p> <p>Press the High Limit soft key to input value.</p> <p>Press the Time Error soft key.</p> <p>Press the Test Limits soft key. Toggle between On and Off.</p> <p>Use the numeric keys to input value.</p> <p>Use the numeric keys to input value.</p> <p>Press the IQ Origin Offset soft key.</p> |

| | |
|---|--|
| <p>[Test Limit] <On> or <Off> [High Limit]</p> | <p>Press the Test Limit soft key. Toggle between On and Off. Use the numeric keys and input a number in dB.</p> |
| <p>2. Enable beep LIMIT [Beep] <On> or <Off></p> | <p>Press the LIMIT hot key. Press the Beep soft key to toggle between On and Off and select one. This will make audible alarm if the measurement result goes beyond the limit.</p> |

- n **FREQUENCY ERROR:** Sets the frequency error limit.
- Y **TEST LIMITS:** Enables or disables the test limit(s). Toggle this soft key between **On** and **Off**.
- Y **HIGH LIMIT:** Sets the upper limit. Use the numeric keys to input value and press the unit soft key or the **ENTER** hard key to complete the input.
- Y **LOW LIMIT:** Sets the lower limit. Use the numeric keys to input value and press the unit soft key or the **ENTER** hard key to complete the input.
- n **EVM:** Sets limits for Error Vector Magnitude.
 - Y **PDSCH EVM:** Sets the limit of the PDSCH EVM.
 - **TEST LIMITS:** Enables or disables the test limit. Toggle this key between **On** and **Off**.
 - **HIGH LIMIT (QPSK):** Sets the upper limit of QPSK. Use the numeric keys to input value and press the unit soft key or the **ENTER** hard key to complete the input.
 - **HIGH LIMIT (16QAM):** Sets the upper limit of 16QAM. Use the numeric keys to input value and press the unit soft key or the **ENTER** hard key to complete the input.
 - **HIGH LIMIT (64QAM):** Sets the upper limit of 64QAM. Use the numeric keys to input value and press the unit soft key or the **ENTER** hard key to complete the input.
 - Y **DATA EVM RMS:** Sets the rms limit of the Data EVM.
 - **TEST LIMITS:** Enables or disables the test limit. Toggle this key between **On** and **Off**.
 - **HIGH LIMIT:** Sets the upper limit. Use the numeric keys to input value and press the unit soft key or the **ENTER** hard key to complete the input.
 - Y **DATA EVM PEAK:** Sets the peak limit of the Data EVM.
 - **TEST LIMITS:** Enables or disables the test limit. Toggle this key between **On** and **Off**.
 - **HIGH LIMIT:** Sets the upper limit. Use the numeric keys to input value and press the unit soft key or the **ENTER** hard key to complete the input.
 - Y **RS EVM:** *This key is not used in the Constellation mode.*
 - Y **P-SS EVM:** *This key is not used in the Constellation mode.*

- Y **S-SS EVM:** This key is not used in the Constellation mode.
- n **POWER:** This key is not used in the Constellation mode.
- n **TIME ALIGNMENT ERROR:** This key is not used in the Constellation mode.
- n **TIME ERROR:** Sets the limit of the Time Error.
- Y **TEST LIMITS:** Enables or disables the test limits. Toggle this soft key between **On** and **Off**.
- Y **HIGH LIMIT:** Sets the upper limit. Use the numeric keys to input value and press the unit soft key or the **ENTER** hard key to complete the input.
- Y **LOW LIMIT:** Sets the lower limit. Use the numeric keys to input value and press the unit soft key or the **ENTER** hard key to complete the input.
- n **IQ ORIGIN OFFSET:** Sets the limit of I/Q origin offset.
- Y **TEST LIMIT:** Enables or disables the test limit. Toggle this soft key between **On** and **Off**.
- Y **HIGH LIMIT:** Sets the upper limit. Use the numeric keys to input value and press the unit soft key or the **ENTER** hard key to complete the input.

Measurement Example

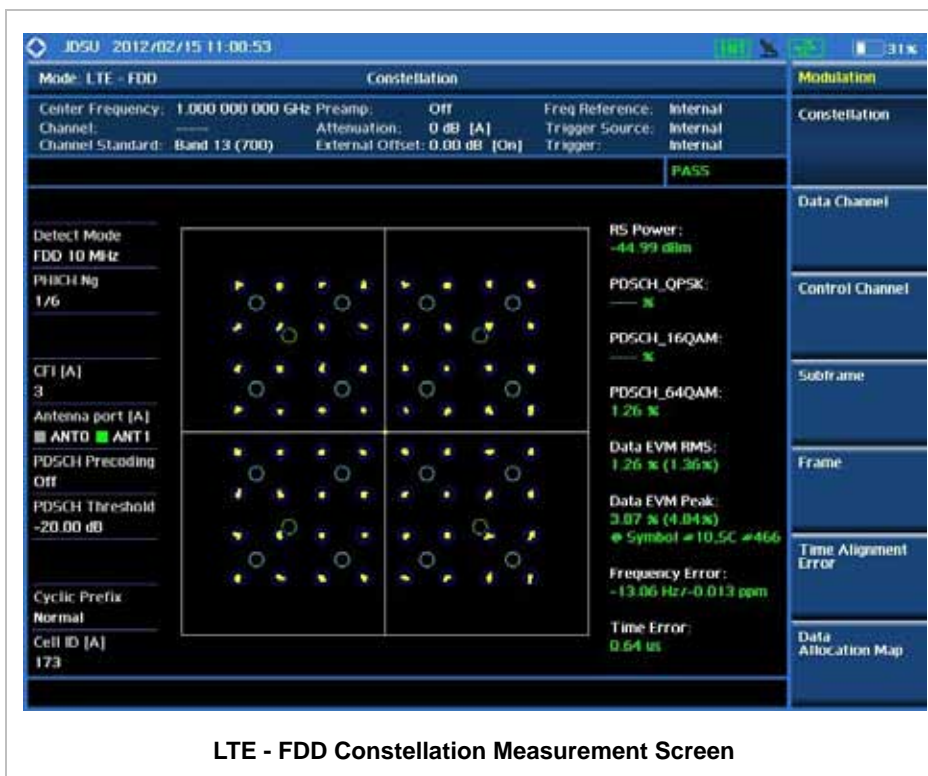

DATA CHANNEL

Data Channel measures the constellation for the specified resource block as well as the modulation accuracy of each PDSCH at the specified subframe.

Measurement Procedure

| Step | Description |
|---|--|
| 1. Set the measurement mode MEASURE [Modulation Analysis] [Data Channel] | Press the MEASURE hot key. Press the Modulation Analysis soft key. Press the Data Channel soft key. |
| 2. Set the measurement parameters MEASURE SETUP [Bandwidth] [1.4 MHz], [3 MHz], [5 MHz], [10 MHz], [15 MHz], or [20 MHz] [Subframe No] Enter a value [Enter] [PHICH Ng] [1/6], [1/2], [1], [2], [E-1/6], [E-1/2], [E-1], or [E-2] [CFI] <Auto> or <Manual> Enter a value [Enter] [Cell ID] <Auto> or <Manual> Enter a value [Enter] [Event Hold] <On> or <Off> | Press the MEASURE SETUP hot key. Press the Bandwidth soft key. Press one of the soft keys to select. Press the Subframe No soft key. Use the numeric keys to input value. Press the Enter soft key to complete the input. Press the PHICH Ng soft key. Select one of the soft keys to set the number of PHICH groups (Ng). Press the CFI soft key to toggle between Auto and Manual . Use the numeric keys to manually input value. Press the Enter soft key. Press the Cell ID soft key. Toggle between Auto and Manual . Use the numeric keys to set the Cell ID manually. Press the Enter soft key. Press the Event Hold soft key. Toggle this key between On and Off . |

LTE - FDD Data Channel Measurement Procedure



MEASURE SETUP

- n **BANDWIDTH:** Selects the nominal channel bandwidth to be measured among **1.4 MHz**, **3 MHz**, **5 MHz**, **10 MHz**, **15 MHz**, and **20 MHz**.
- n **SUBFRAME NO:** Sets the subframe number to be measured.
- n **CELL ID:** Enables or disables automatic detection of the Cell ID of the transmitted LTE signal. Manually setting the Cell ID to a specific one can speed up to get synchronization with BTS.
 - Y **AUTO:** Detects the Cell ID automatically.
 - Y **MANUAL:** Sets the Cell ID to a specific one.
- n **CFI:** Sets the number of OFDM symbols used for transmission of PDCCHs in a subframe. Toggle this soft key between **Auto** and **Manual**. The set of OFDM symbols that can be used for PDCCH in a subframe is given by **0**, **2**, **3** or **4** in 1.4 MHz bandwidth and **1**, **2**, or **3** in other bandwidths.
- n **PHICH Ng:** Sets the number of PHICH groups (Ng) which is constant in all subframes. Choose the PHICH Ng among **1/6**, **1/2**, **1**, **2**, **E-1/6**, **E-1/2**, **E-1**, or **E-2**.
- n **EVENT HOLD:** Turns the event hold function on or off. Toggle this key between **On** and **Off**. Event hold is used to put the measurement screen on hold in the event of active data measured if the Event Hold is set to On. It enables you to view detailed current resource block on the I-Q diagram, particularly in a dynamic field environment. The display screen shows the red **HOLD** on it to indicate an event on hold. To reset the current event hold, press the **Hold** hot key and the red **HOLD** indicator will disappear until the next event.
- n **MISCELLANEOUS**
 - Y **ANTENNA PORT:** Sets the antenna port number automatically or manually. Each time this soft key is pressed, selection changes among **Auto**, **0**, and **1**.
 - Y **CYCLIC PREFIX:** Sets the cyclic prefix to **Normal** or **Extended**. For OFDM parameter details by different bandwidth, refer to the table in the Appendix E – Cyclic Prefix Table.
 - Y **PDSCH MODULATION TYPE:** Sets the modulation type in a frame among **Auto**, **QPSK**, **16QAM**, **64QAM**, **E-TM3.3**, **E-TM3.2**, **E-TM3.1**, **E-TM2**, **E-TM1.2**, and **E-TM1.1**. If two or more modulation types are used in a frame, set the PDSCH Modulation Type to **Auto**. If the PDSCH uses the same modulation type in a frame or in a subframe, set it to specific modulation type to get more accurate EVM.
 - Y **PDSCH THRESHOLD:** Sets the threshold of PDSCH. Use the numeric keys to input value and press the **dB** unit soft key to complete the input.

Setting Limit

LIMIT



This hot key is used to set the threshold value for the limit line on the display screen. It turns on or off the limit or band limit settings of the measurement for pass/fail indication. The user input window must be inactive first to get the Limit hot key function other than the number input.

| Step | Description |
|---|---|
| 1. Select the limit mode LIMIT [Modulation Test Limits] [EVM] [Data EVM RMS] [Test Limits] <On> or <Off> [High Limit] [Data EVM Peak] [Test Limits] <On> or <Off> [High Limit] [IQ Origin Offset] [Test Limit] <On> or <Off> [High Limit] | Press the LIMIT hot key. Press the Modulation Test Limits soft key. Press the EVM soft key. Press the Data EVM RMS soft key. Press the Test Limits soft key. Toggle between On and Off . Press the High Limit soft key to input value. Press the Data EVM Peak soft key. Press the Test Limits soft key. Toggle between On and Off . Press the High Limit soft key to input value. Press the IQ Origin Offset soft key. Press the Test Limit soft key. Toggle between On and Off . Use the numeric keys and input a number in dB. |
| 2. Enable beep LIMIT [Beep] <On> or <Off> | Press the LIMIT hot key. Press the Beep soft key to toggle between On and Off and select one. This will make audible alarm if the measurement result goes beyond the limit. |

n **FREQUENCY ERROR:** *This key is not used in the Data Channel mode.*

n **EVM:** Sets limits for Error Vector Magnitude.

Y **PDSCH EVM:** *This key is not used in the Data Channel mode.*

Y **DATA EVM RMS:** Sets the rms limit of the Data EVM.

- **TEST LIMITS:** Enables or disables the test limit. Toggle this key between **On** and **Off**.

- **HIGH LIMIT:** Sets the upper limit. Use the numeric keys to input value and press the unit soft key or the **ENTER** hard key to complete the input.

Y **DATA EVM PEAK:** Sets the peak limit of the Data EVM.

- **TEST LIMITS:** Enables or disables the test limit. Toggle this key between **On** and **Off**.
 - **HIGH LIMIT:** Sets the upper limit. Use the numeric keys to input value and press the unit soft key or the **ENTER** hard key to complete the input.
- Y **RS EVM:** This key is not used in the Data Channel mode.
 - Y **P-SS EVM:** This key is not used in the Data Channel mode.
 - Y **S-SS EVM:** This key is not used in the Data Channel mode.
- n **POWER:** This key is not used in the Data Channel mode.
 - n **TIME ALIGNMENT ERROR:** This key is not used in the Data Channel mode.
 - n **TIME ERROR:** This key is not used in the Data Channel mode.
 - n **IQ ORIGIN OFFSET:** Sets the limit of I/Q origin offset.
- Y **TEST LIMIT:** Enables or disables the test limit. Toggle this soft key between **On** and **Off**.
 - Y **HIGH LIMIT:** Sets the upper limit. Use the numeric keys to input value and press the unit soft key or the **ENTER** hard key to complete the input.

Measurement Example

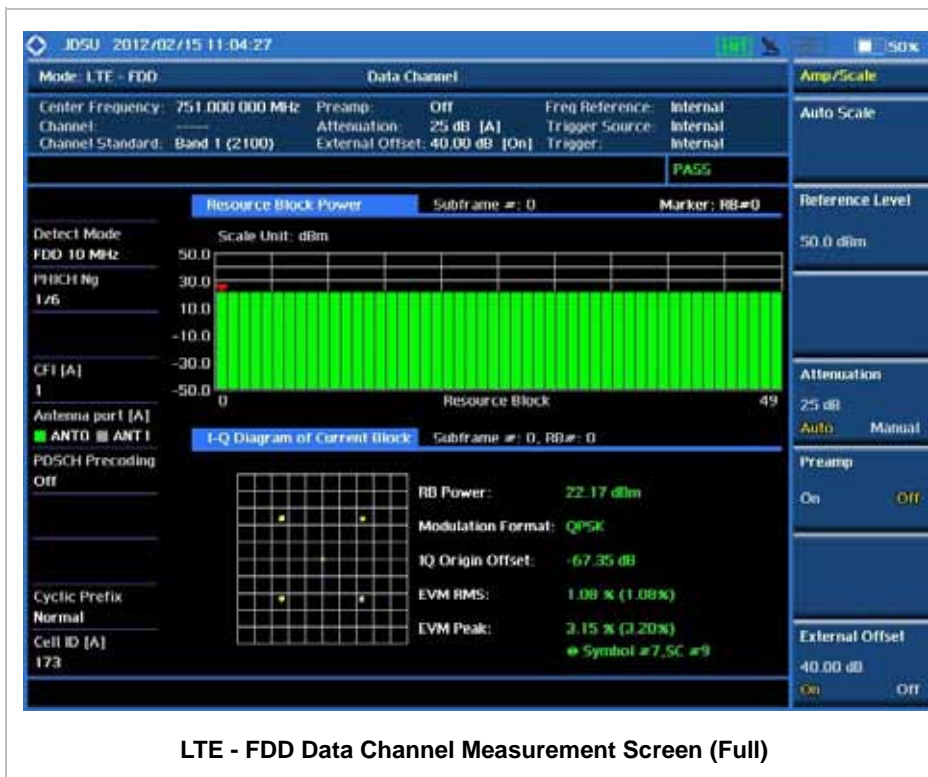

LTE - FDD Data Channel Measurement Screen (Full)

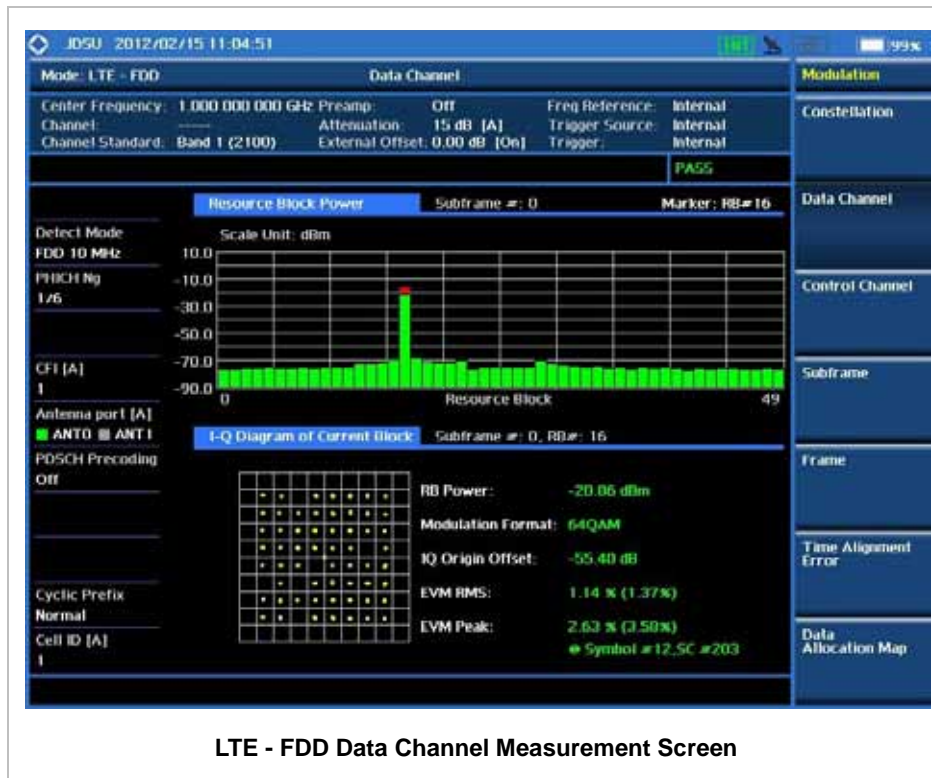

Using Marker

MARKER



- n **IQ DIAGRAM:** IQ Diagram operates based on the resource block designated by marker. Enable or disable the IQ diagram display on the screen by toggling this soft key between **On** and **Off**.
- n **RB NUMBER:** Sets the resource block (RB) number to be displayed. Press this soft key and use the rotary knob to move the resource block back and forth. Or use the numeric keys to enter a value and then press the **Enter** soft key to complete the input. Once the RB number is set after setting the IQ Diagram display option to On, IQ diagram shows details of the selected resource block.

CONTROL CHANNEL

Control Channel measures the constellation for the specified control channel as well as modulation accuracy of the control channel at the specified subframe.

Measurement Procedure

| Step | Description |
|--|--|
| 1. Set the measurement mode MEASURE [Modulation Analysis] [Control Channel] | Press the MEASURE hot key. Press the Modulation Analysis soft key. Press the Control Channel soft key. |
| 2. Set the measurement parameters MEASURE SETUP [Bandwidth] [1.4 MHz], [3 MHz], [5 MHz], [10 MHz], [15 MHz], or [20 MHz] [Subframe No] Enter a value [Enter] [PHICH Ng] [1/6], [1/2], [1], [2], [E-1/6], [E-1/2], [E-1], or [E-2] [CFI] <Auto> or <Manual> Enter a value [Enter] [Cell ID] <Auto> or <Manual> Enter a value [Enter] | Press the MEASURE SETUP hot key. Press the Bandwidth soft key. Press one of the soft keys to select. Press the Subframe No soft key. Use the numeric keys to input value. Press the Enter soft key to complete the input. Press the PHICH Ng soft key. Select one of the soft keys to set the number of PHICH groups (Ng). Press the CFI soft key to toggle between Auto and Manual . Use the numeric keys to manually input value. Press the Enter soft key. Press the Cell ID soft key. Toggle between Auto and Manual . Use the numeric keys to set the Cell ID manually. Press the Enter soft key. |

LTE - FDD Control Channel Measurement Procedure

MEASURE SETUP



- n **BANDWIDTH:** Selects the nominal channel bandwidth to be measured among **1.4 MHz, 3 MHz, 5 MHz, 10 MHz, 15 MHz,** and **20 MHz.**
- n **SUBFRAME NO:** Sets the subframe number to be measured.
- n **CELL ID:** Enables or disables automatic detection of the Cell ID of the transmitted LTE signal. Manually setting the Cell ID to a specific one can speed up to get synchronization with BTS.
 - Y **AUTO:** Detects the Cell ID automatically.
 - Y **MANUAL:** Sets the Cell ID to a specific one.

- n **CFI:** Sets the number of OFDM symbols used for transmission of PDCCHs in a subframe. Toggle this soft key between **Auto** and **Manual**. The set of OFDM symbols that can be used for PDCCH in a subframe is given by **0, 2, 3** or **4** in 1.4 MHz bandwidth and **1, 2,** or **3** in other bandwidths.
- n **PHICH Ng:** Sets the number of PHICH groups (Ng) which is constant in all subframes. Choose the PHICH Ng among **1/6, 1/2, 1, 2, E-1/6, E-1/2, E-1,** or **E-2**.
- n **MISCELLANEOUS**
 - Y **ANTENNA PORT:** Sets the antenna port number automatically or manually. Each time this soft key is pressed, selection changes among **Auto, 0,** and **1**.
 - Y **CYCLIC PREFIX:** Sets the cyclic prefix to **Normal** or **Extended**. For OFDM parameter details by different bandwidth, refer to the table in the Appendix E – Cyclic Prefix Table.
 - Y **PDCCH THRESHOLD:** Sets the threshold of PDCCH.
 - Y **PDCCH MODE:** Sets the PDCCH mode among **REG** and **Avg**.
 - **REG:** Calculates EVM in accordance with REG (Resource Element Group) settings.
 - **AVG:** Calculates EVM after adding up all PDCCH signals from one subframe.

Setting Limit



This hot key is used to set the threshold value for the limit line on the display screen. It turns on or off the limit or band limit settings of the measurement for pass/fail indication. The user input window must be inactive first to get the Limit hot key function other than the number input.

| Step | Description |
|--|---|
| 1. Select the limit LIMIT [Modulation Test Limits] [Frequency Error] [Test Limits] <On> or <Off> [High Limit] [Low Limit] [EVM] [Data EVM RMS] [Test Limits] <On> or <Off> | Press the LIMIT hot key. Press the Modulation Test Limits soft key. Press the Frequency Error soft key. Press the Test Limits soft key. Toggle between On and Off . Use the numeric keys to input value. Use the numeric keys to input value. Press the EVM soft key. Press the Data EVM RMS soft key. Press the Test Limits soft key. Toggle between On and Off . |

| | |
|---|---|
| <p>[High Limit]</p> <p>[Data EVM Peak]</p> <p>[Test Limits]</p> <p><On> or <Off></p> <p>[High Limit]</p> <p>[IQ Origin Offset]</p> <p>[Test Limit]</p> <p><On> or <Off></p> <p>[High Limit]</p> | <p>Press the High Limit soft key to input value.</p> <p>Press the Data EVM Peak soft key.</p> <p>Press the Test Limits soft key. Toggle between On and Off.</p> <p>Press the High Limit soft key to input value.</p> <p>Press the IQ Origin Offset soft key.</p> <p>Press the Test Limit soft key. Toggle between On and Off.</p> <p>Use the numeric keys and input a number in dB.</p> |
| <p>2. Enable beep</p> <p>LIMIT</p> <p>[Beep]</p> <p><On> or <Off></p> | <p>Press the LIMIT hot key.</p> <p>Press the Beep soft key to toggle between On and Off and select one. This will make audible alarm if the measurement result goes beyond the limit.</p> |

- n **FREQUENCY ERROR:** Sets the frequency error limit.
 - Y **TEST LIMITS:** Enables or disables the test limits. Toggle this soft key between **On** and **Off**.
 - Y **HIGH LIMIT:** Sets the upper limit. Use the numeric keys to input value and press the unit soft key or the **ENTER** hard key to complete the input.
 - Y **LOW LIMIT:** Sets the lower limit. Use the numeric keys to input value and press the unit soft key or the **ENTER** hard key to complete the input.
- n **EVM:** Sets limits for Error Vector Magnitude.
 - Y **PDSCH EVM:** *This key is not used in the Control Channel mode.*
 - Y **DATA EVM RMS:** Sets the rms limit of the Data EVM.
 - **TEST LIMITS:** Enables or disables the test limit. Toggle this soft key between **On** and **Off**.
 - **HIGH LIMIT:** Sets the upper limit. Use the numeric keys to input value and press the unit soft key or the **ENTER** hard key to complete the input.
 - Y **DATA EVM PEAK:** Sets the peak limit of the Data EVM.
 - **TEST LIMITS:** Enables or disables the test limit. Toggle this soft key between **On** and **Off**.
 - **HIGH LIMIT:** Sets the upper limit. Use the numeric keys to input value and press the unit soft key or the **ENTER** hard key to complete the input.
 - Y **RS EVM:** *This key is not used in the Control Channel mode.*

- Y **P-SS EVM:** This key is not used in the Control Channel mode.
- Y **S-SS EVM:** This key is not used in the Control Channel mode.
- n **POWER:** This key is not used in the Control Channel mode.
- n **TIME ALIGNMENT ERROR:** This key is not used in the Control Channel mode.
- n **TIME ERROR:** This key is not used in the Control Channel mode.
- n **IQ ORIGIN OFFSET:** Sets the limit of I/Q origin offset.
- Y **TEST LIMIT:** Enables or disables the test limit. Toggle this soft key between **On** and **Off**.
- Y **HIGH LIMIT:** Sets the upper limit. Use the numeric keys to input value and press the unit soft key or the **ENTER** hard key to complete the input.

Measurement Example

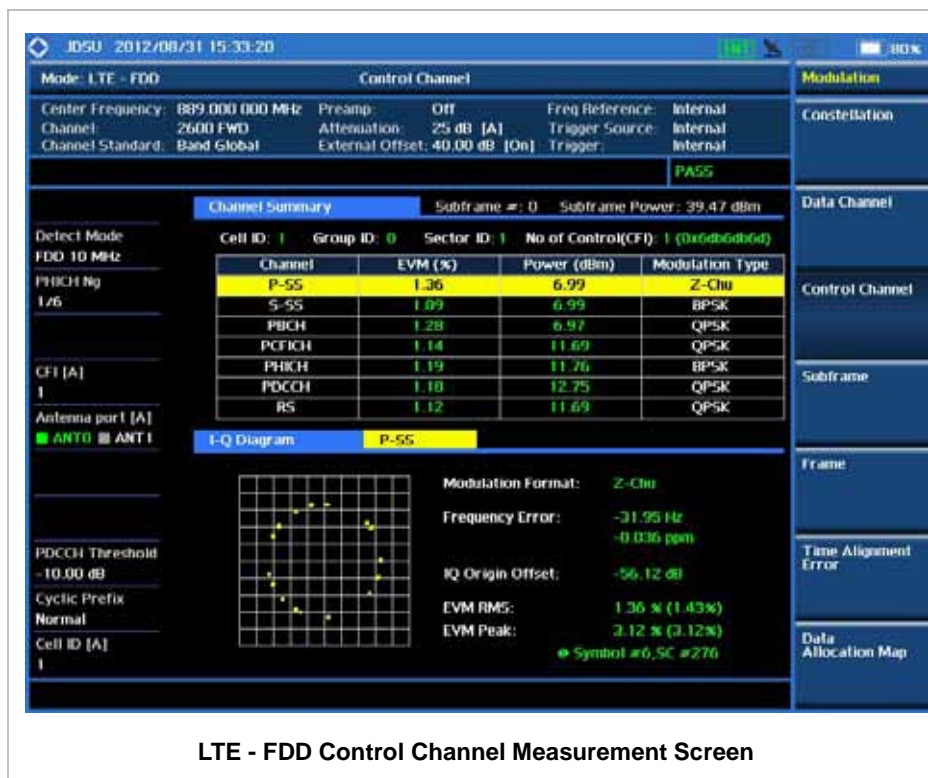

Using Marker

MARKER



- n **IQ DIAGRAM:** IQ Diagram operates based on the resource block designated by marker. Enable or disable the IQ diagram display on the screen by toggling this soft key between **On** and **Off**.
- n **CHANNEL:** Changes the channel to be displayed in the IQ Diagram on the display screen. The

channel P-SS is set by default. Press this soft key and use the rotary knob or the arrow keys to change the channel to the others in the channel summary table. The IQ diagram shows details of the selected channel accordingly.

SUBFRAME

Subframe measures the modulation accuracy of all the data and control channels at the specified subframe (1 ms).

Measurement Procedure

| Step | Description |
|--|--|
| 1. Set the measurement mode MEASURE [Modulation Analysis] [Subframe] | Press the MEASURE hot key. Press the Modulation Analysis soft key. Press the Subframe soft key. |
| 2. Set the measurement parameters MEASURE SETUP [Bandwidth] [1.4 MHz], [3 MHz], [5 MHz], [10 MHz], [15 MHz], or [20 MHz] [Subframe No] Enter a value [Enter] [PHICH Ng] [1/6], [1/2], [1], [2], [E-1/6], [E-1/2], [E-1], or [E-2] [CFI] <Auto> or <Manual> Enter a value [Enter] [Cell ID] <Auto> or <Manual> Enter a value | Press the MEASURE SETUP hot key. Press the Bandwidth soft key. Press one of the soft keys to select. Press the Subframe No soft key. Use the numeric keys to input value. Press the Enter soft key to complete the input. Press the PHICH Ng soft key. Select one of the soft keys to set the number of PHICH groups (Ng). Press the CFI soft key to toggle between Auto and Manual . Use the numeric keys to manually input value. Press the Enter soft key. Press the Cell ID soft key. Toggle between Auto and Manual . Use the numeric keys to set the Cell ID manually. |

[Enter]

Press the **Enter** soft key.

LTE - FDD Subframe Measurement Procedure

MEASURE SETUP

- n **BANDWIDTH:** Selects the nominal channel bandwidth to be measured among **1.4 MHz, 3 MHz, 5 MHz, 10 MHz, 15 MHz,** and **20 MHz.**
- n **SUBFRAME NO:** Sets the subframe number to be measured.
- n **CELL ID:** Enables or disables automatic detection of the Cell ID of the transmitted LTE signal. Manually setting the Cell ID to a specific one can speed up to get synchronization with BTS.
 - Y **AUTO:** Detects the Cell ID automatically.
 - Y **MANUAL:** Sets the Cell ID to a specific one.
- n **CFI:** Sets the number of OFDM symbols used for transmission of PDCCHs in a subframe. Toggle this soft key between **Auto** and **Manual**. The set of OFDM symbols that can be used for PDCCH in a subframe is given by **0, 2, 3** or **4** in 1.4 MHz bandwidth and **1, 2,** or **3** in other bandwidths.
- n **PHICH Ng:** Sets the number of PHICH groups (Ng) which is constant in all subframes. Choose the PHICH Ng among **1/6, 1/2, 1, 2, E-1/6, E-1/2, E-1,** or **E-2.**
- n **MISCELLANEOUS**
 - Y **ANTENNA PORT:** Sets the antenna port number automatically or manually. Each time this soft key is pressed, selection changes among **Auto, 0,** and **1.**
 - Y **CYCLIC PREFIX:** Sets the cyclic prefix to **Normal** or **Extended**. For OFDM parameter details by different bandwidth, refer to the table in the Appendix E – Cyclic Prefix Table.
 - Y **PDSCH MODULATION TYPE:** Sets the modulation type in a frame among **Auto, QPSK, 16QAM, 64QAM, E-TM3.3, E-TM3.2, E-TM3.1, E-TM2, E-TM1.2,** and **E-TM1.1.** If two or more modulation types are used in a frame, set the PDSCH Modulation Type to **Auto**. If the PDSCH uses the same modulation type in a frame or in a subframe, set it to specific modulation type to get more accurate EVM.
 - Y **PDSCH THRESHOLD:** Sets the threshold of PDSCH. Use the numeric keys to input value and press the **dB** unit soft key to complete the input.
 - Y **PDCCH THRESHOLD:** Sets the threshold of PDCCH.
 - Y **PDCCH MODE:** Sets the PDCCH mode among **REG** and **Avg.**
 - **REG:** Calculates EVM in accordance with REG (Resource Element Group) settings.
 - **AVG:** Calculates EVM after adding up all PDCCH signals from one subframe.

Setting Limit



This hot key is used to set the threshold value for the limit line on the display screen. It turns on or off the limit or band limit settings of the measurement for pass/fail indication. The user input window must be inactive first to get the Limit hot key function other than the number input.

| Step | Description |
|--|---|
| <p>1. Select the limit</p> <p>LIMIT</p> <p>[Modulation Test Limits]</p> <p>[Frequency Error]</p> <p>[Test Limits]</p> <p><On> or <Off></p> <p>[High Limit]</p> <p>[Low Limit]</p> <p>[EVM]</p> <p>[Data EVM RMS]</p> <p>[Test Limits]</p> <p><On> or <Off></p> <p>[High Limit]</p> <p>[Data EVM Peak]</p> <p>[Test Limits]</p> <p><On> or <Off></p> <p>[High Limit]</p> <p>[RS EVM]</p> <p>[Test Limits]</p> <p><On> or <Off></p> <p>[High Limit]</p> <p>[Power]</p> <p>[DL RS Power]</p> <p>[Test Limits]</p> <p><On> or <Off></p> <p>[High Limit]</p> <p>[Low Limit]</p> <p>[P-SS Power]</p> <p>[Test Limits]</p> | <p>Press the LIMIT hot key.</p> <p>Press the Modulation Test Limits soft key.</p> <p>Press the Frequency Error soft key.</p> <p>Press the Test Limits soft key. Toggle between On and Off.</p> <p>Use the numeric keys to input value.</p> <p>Use the numeric keys to input value.</p> <p>Press the EVM soft key.</p> <p>Press the Data EVM RMS soft key.</p> <p>Press the Test Limits soft key. Toggle between On and Off.</p> <p>Press the High Limit soft key to input value.</p> <p>Press the Data EVM Peak soft key.</p> <p>Press the Test Limits soft key. Toggle between On and Off.</p> <p>Press the High Limit soft key to input value.</p> <p>Press the RS EVM soft key.</p> <p>Press the Test Limits soft key. Toggle between On and Off.</p> <p>Use the numeric keys and input.</p> <p>Press the Power soft key.</p> <p>Press the DL RS Power soft key.</p> <p>Press the Test Limits soft key. Toggle between On and Off.</p> <p>Use the numeric keys and input.</p> <p>Use the numeric keys and input.</p> <p>Press the P-SS Power soft key.</p> <p>Press the Test Limit soft key. Toggle between On and</p> |

| | |
|---|---|
| <p><On> or <Off> [High Limit] [Low Limit]</p> <p>[S-SS Power] [Test Limits] <On> or <Off> [High Limit] [Low Limit]</p> <p>[PBCH Power] [Test Limits] <On> or <Off> [High Limit] [Low Limit]</p> <p>[Subframe Power] [Test Limits] <On> or <Off> [High Limit] [Low Limit]</p> <p>[OFDM Symbol Power] [Test Limits] <On> or <Off> [High Limit] [Low Limit]</p> <p>[Time Error] [Test Limits] <On> or <Off> [High Limit] [Low Limit]</p> | <p>Off. Use the numeric keys and input. Use the numeric keys and input.</p> <p>Press the S-SS Power soft key. Press the Test Limit soft key. Toggle between On and Off. Use the numeric keys and input. Use the numeric keys and input.</p> <p>Press the PBCH Power soft key. Press the Test Limit soft key. Toggle between On and Off. Use the numeric keys and input. Use the numeric keys and input.</p> <p>Press the Subframe Power soft key. Press the Test Limit soft key. Toggle between On and Off. Use the numeric keys and input. Use the numeric keys and input.</p> <p>Press the OFDM Symbol Power soft key. Press the Test Limit soft key. Toggle between On and Off. Use the numeric keys and input. Use the numeric keys and input.</p> <p>Press the Time Error soft key. Press the Test Limits soft key. Toggle between On and Off. Use the numeric keys to input value. Use the numeric keys to input value.</p> |
| <p>2. Enable beep LIMIT [Beep] <On> or <Off></p> | <p>Press the LIMIT hot key. Press the Beep soft key to toggle between On and Off and select one. This will make audible alarm if the measurement result goes beyond the limit.</p> |

n **FREQUENCY ERROR:** Sets the frequency error limit.

Y **TEST LIMITS:** Enables or disables the test limits. Toggle this soft key between **On** and **Off**.

Y **HIGH LIMIT:** Sets the upper limit. Use the numeric keys to input value and press the unit soft key or the **ENTER** hard key to complete the input.

- Y **LOW LIMIT:** Sets the lower limit. Use the numeric keys to input value and press the unit soft key or the **ENTER** hard key to complete the input.
- n **EVM:** Sets limits for Error Vector Magnitude.
 - Y **PDSCH EVM:** *This key is not used in the Subframe mode.*
 - Y **DATA EVM RMS:** Sets the rms limit of the Data EVM.
 - **TEST LIMITS:** Enables or disables the test limit. Toggle this soft key between **On** and **Off**.
 - **HIGH LIMIT:** Sets the upper limit. Use the numeric keys to input value and press the unit soft key or the **ENTER** hard key to complete the input.
 - Y **DATA EVM PEAK:** Sets the peak limit of the Data EVM.
 - **TEST LIMITS:** Enables or disables the test limit. Toggle this soft key between **On** and **Off**.
 - **HIGH LIMIT:** Sets the upper limit. Use the numeric keys to input value and press the unit soft key or the **ENTER** hard key to complete the input.
 - Y **RS EVM:** Sets the RS EVM.
 - **TEST LIMITS:** Enables or disables the test limits. Toggle this soft key between **On** and **Off**.
 - **HIGH LIMIT:** Sets the upper limit. Use the numeric keys to input value and press the unit soft key or the **ENTER** hard key to complete the input.
 - Y **P-SS EVM:** *This key is not used in the Subframe mode.*
 - Y **S-SS EVM:** *This key is not used in the Subframe mode.*
- n **POWER:** Set power limits.
 - Y **DL RS POWER:** Sets the Downlink RS power limit.
 - **TEST LIMITS:** Enables or disables the test limits. Toggle this soft key between **On** and **Off**.
 - **HIGH LIMIT:** Sets the upper limit. Use the numeric keys to input value and press the unit soft key or the **ENTER** hard key to complete the input.
 - **LOW LIMIT:** Sets the lower limit. Use the numeric keys to input value and press the unit soft key or the **ENTER** hard key to complete the input.
 - Y **P-SS POWER:** Sets the P-SS power limit.
 - **TEST LIMITS:** Enables or disables the test limits. Toggle this soft key between **On** and **Off**.
 - **HIGH LIMIT:** Sets the upper limit. Use the numeric keys to input value and press the

unit soft key or the **ENTER** hard key to complete the input.

- **LOW LIMIT:** Sets the lower limit. Use the numeric keys to input value and press the unit soft key or the **ENTER** hard key to complete the input.

Y **S-SS POWER:** Sets the S-SS power limit.

- **TEST LIMITS:** Enables or disables the test limits. Toggle this soft key between **On** and **Off**.
- **HIGH LIMIT:** Sets the upper limit. Use the numeric keys to input value and press the unit soft key or the **ENTER** hard key to complete the input.
- **LOW LIMIT:** Sets the lower limit. Use the numeric keys to input value and press the unit soft key or the **ENTER** hard key to complete the input.

Y **PBCH POWER:** Sets the PBCH power limit.

- **TEST LIMITS:** Enables or disables the test limits. Toggle this soft key between **On** and **Off**.
- **HIGH LIMIT:** Sets the upper limit. Use the numeric keys to input value and press the unit soft key or the **ENTER** hard key to complete the input.
- **LOW LIMIT:** Sets the lower limit. Use the numeric keys to input value and press the unit soft key or the **ENTER** hard key to complete the input.

Y **SUBFRAME POWER:** Sets the subframe power limit.

- **TEST LIMITS:** Enables or disables the test limits. Toggle this soft key between **On** and **Off**.
- **HIGH LIMIT:** Sets the upper limit. Use the numeric keys to input value and press the unit soft key or the **ENTER** hard key to complete the input.
- **LOW LIMIT:** Sets the lower limit. Use the numeric keys to input value and press the unit soft key or the **ENTER** hard key to complete the input.

Y **OFDM SYMBOL POWER:** Sets the OFDM symbol power limit.

- **TEST LIMITS:** Enables or disables the test limits. Toggle this soft key between **On** and **Off**.
- **HIGH LIMIT:** Sets the upper limit. Use the numeric keys to input value and press the unit soft key or the **ENTER** hard key to complete the input.
- **LOW LIMIT:** Sets the lower limit. Use the numeric keys to input value and press the unit soft key or the **ENTER** hard key to complete the input.

Y **FRAME AVG POWER:** *This key is not used in the Subframe mode.*

n **TIME ALIGNMENT ERROR:** *This key is not used in the Subframe mode.*

- n **TIME ERROR:** Sets the limit of the Time Error.
- Y **TEST LIMITS:** Enables or disables the test limits. Toggle this soft key between **On** and **Off**.
- Y **HIGH LIMIT:** Sets the upper limit. Use the numeric keys to input value and press the unit soft key or the **ENTER** hard key to complete the input.
- Y **LOW LIMIT:** Sets the lower limit. Use the numeric keys to input value and press the unit soft key or the **ENTER** hard key to complete the input.
- n **IQ ORIGIN OFFSET:** *This key is not used in the Subframe mode.*

Setting Display



- n **CHART:** Turns the chart on the display screen on or off. Toggle between **On** and **Off**. When this function is turned on, the measurement screen will be changed to Chart view and the Marker hard key function will be activated.

Measurement Example

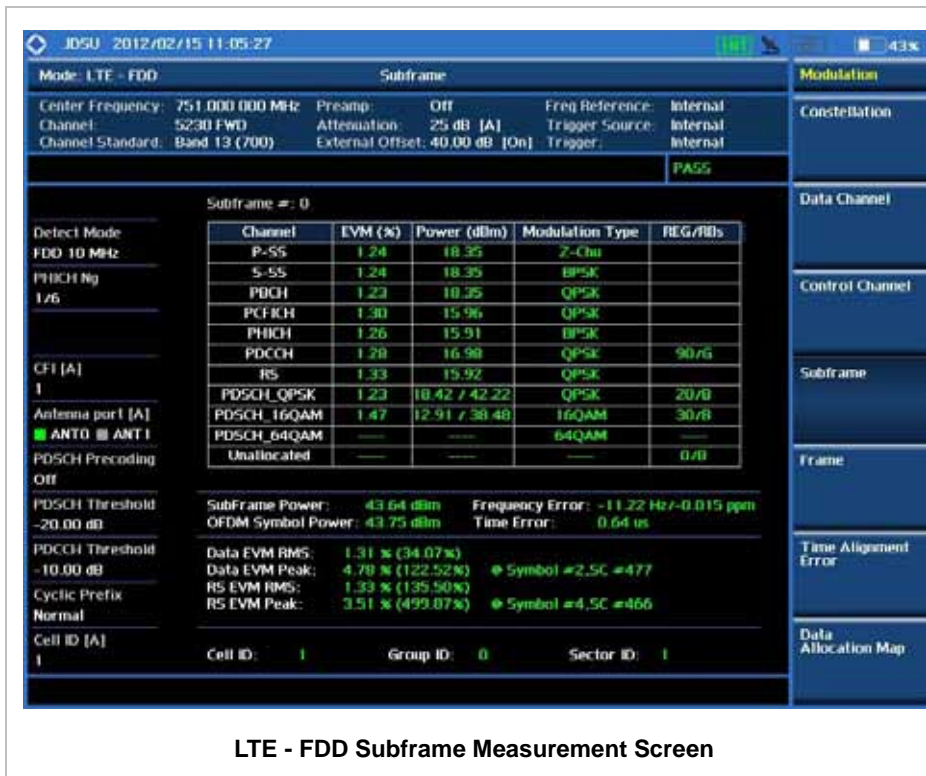

The following example shows the display screen when the **Chart** soft menu is set to **On** in

Trace/Display hard key function.

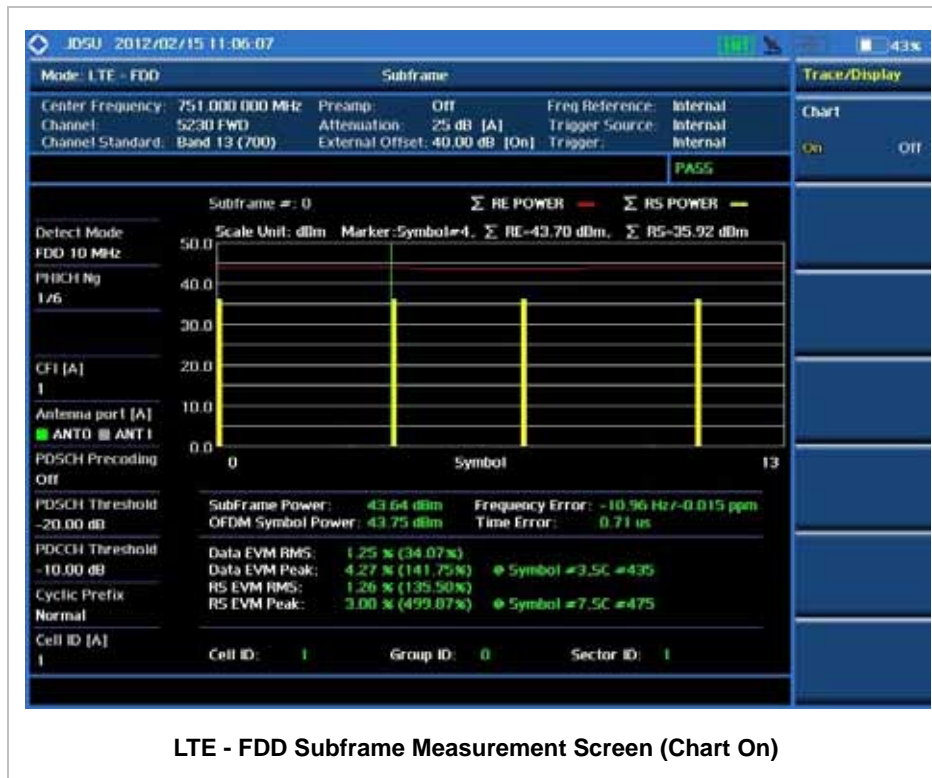

Using Marker

MARKER



- n **MARKER VIEW:** IQ Diagram operates based on the resource block designated by marker. Enable or disable the IQ diagram display on the screen by toggling this soft key between **On** and **Off**.
- n **NORMAL:** This Normal marker type provides the reading of a marker position on the trace along with the marker number between 1 and 6.

FRAME

Frame measures the modulation accuracy of all the data and control channels at the specified frame (10 ms).

Measurement Procedure

| Step | Description |
|---|--|
| 1. Set the measurement mode MEASURE [Modulation Analysis] [Frame] | Press the MEASURE hot key. Press the Modulation Analysis soft key. Press the Frame soft key. |
| 2. Set the measurement parameters MEASURE SETUP [Bandwidth] [1.4 MHz], [3 MHz], [5 MHz], [10 MHz], [15 MHz], or [20 MHz] [PHICH Ng] [1/6], [1/2], [1], [2], [E-1/6], [E-1/2], [E-1], or [E-2] [CFI] <Auto> or <Manual> Enter a value [Enter] [Cell ID] <Auto> or <Manual> Enter a value [Enter] | Press the MEASURE SETUP hot key. Press the Bandwidth soft key. Press one of the soft keys to select. Press the PHICH Ng soft key. Select one of the soft keys to set the number of PHICH groups (Ng). Press the CFI soft key to toggle between Auto and Manual . Use the numeric keys to manually input value. Press the Enter soft key. Press the Cell ID soft key. Toggle between Auto and Manual . Use the numeric keys to set the Cell ID manually. Press the Enter soft key. |

LTE - FDD Frame Measurement Procedure

MEASURE SETUP



- n **BANDWIDTH:** Selects the nominal channel bandwidth to be measured among **1.4 MHz, 3 MHz, 5 MHz, 10 MHz, 15 MHz, and 20 MHz**.
- n **PHICH Ng:** Sets the number of PHICH groups (Ng) which is constant in all subframes. Choose the PHICH Ng among **1/6, 1/2, 1, 2, E-1/6, E-1/2, E-1, or E-2**.
- n **CELL ID:** Enables or disables automatic detection of the Cell ID of the transmitted LTE signal. Manually setting the Cell ID to a specific one can speed up to get synchronization with BTS.
 - Y **AUTO:** Detects the Cell ID automatically.
 - Y **MANUAL:** Sets the Cell ID to a specific one.
- n **CFI:** Sets the number of OFDM symbols used for transmission of PDCCHs in a subframe. Toggle this soft key between **Auto** and **Manual**. The set of OFDM symbols that can be used for PDCCH in a subframe is given by **0, 2, 3 or 4** in 1.4 MHz bandwidth and **1, 2, or 3** in other bandwidths.

- n **PHICH Ng:** Sets the number of PHICH groups (Ng) which is constant in all subframes. Choose the PHICH Ng among **1/6, 1/2, 1, 2, E-1/6, E-1/2, E-1, or E-2.**
- n **MISCELLANEOUS**
 - Y **ANTENNA PORT:** Sets the antenna port number automatically or manually. Each time this soft key is pressed, selection changes among **Auto, 0, and 1.**
 - Y **CYCLIC PREFIX:** Sets the cyclic prefix to **Normal** or **Extended.** For OFDM parameter details by different bandwidth, refer to the table in the Appendix E – Cyclic Prefix Table.
 - Y **PDSCH MODULATION TYPE:** Sets the modulation type in a frame among **Auto, QPSK, 16QAM, 64QAM, E-TM3.3, E-TM3.2, E-TM3.1, E-TM2, E-TM1.2, and E-TM1.1.** If two or more modulation types are used in a frame, set the PDSCH Modulation Type to **Auto.** If the PDSCH uses the same modulation type in a frame or in a subframe, set it to specific modulation type to get more accurate EVM.
 - Y **PDSCH THRESHOLD:** Sets the threshold of PDSCH. Use the numeric keys to input value and press the **dB** unit soft key to complete the input.
 - Y **PDCCH THRESHOLD:** Sets the threshold of PDCCH.
 - Y **PDCCH MODE:** Sets the PDCCH mode among **REG** and **Avg.**
 - **REG:** Calculates EVM in accordance with REG (Resource Element Group) settings.
 - **AVG:** Calculates EVM after adding up all PDCCH signals from one subframe.

Setting Limit



This hot key is used to set the threshold value for the limit line on the display screen. It turns on or off the limit or band limit settings of the measurement for pass/fail indication. The user input window must be inactive first to get the Limit hot key function other than the number input.

| Step | Description |
|---|---|
| 1. Select the limit LIMIT [Modulation Test Limits] [Frequency Error] [Test Limits] <On> or <Off> [High Limit] [Low Limit] | Press the LIMIT hot key. Press the Modulation Test Limits soft key. Press the Frequency Error soft key. Press the Test Limits soft key. Toggle between On and Off. Use the numeric keys to input value. Use the numeric keys to input value. |

| | |
|---------------------|--|
| [EVM] | Press the EVM soft key. |
| [Data EVM RMS] | Press the Data EVM RMS soft key. |
| [Test Limits] | Press the Test Limits soft key. Toggle between On and Off . |
| <On> or <Off> | |
| [High Limit] | Press the High Limit soft key to input value. |
| [Data EVM Peak] | Press the Data EVM Peak soft key. |
| [Test Limits] | Press the Test Limits soft key. Toggle between On and Off . |
| <On> or <Off> | |
| [High Limit] | Press the High Limit soft key to input value. |
| [RS EVM] | Press the RS EVM soft key. |
| [Test Limits] | Press the Test Limits soft key. Toggle between On and Off . |
| <On> or <Off> | |
| [High Limit] | Use the numeric keys and input. |
| [Power] | Press the Power soft key. |
| [P-SS Power] | Press the P-SS Power soft key. |
| [Test Limits] | Press the Test Limit soft key. Toggle between On and Off . |
| <On> or <Off> | |
| [High Limit] | Use the numeric keys and input. |
| [Low Limit] | Use the numeric keys and input. |
| [S-SS Power] | Press the S-SS Power soft key. |
| [Test Limits] | Press the Test Limit soft key. Toggle between On and Off . |
| <On> or <Off> | |
| [High Limit] | Use the numeric keys and input. |
| [Low Limit] | Use the numeric keys and input. |
| [PBCH Power] | Press the PBCH Power soft key. |
| [Test Limits] | Press the Test Limit soft key. Toggle between On and Off . |
| <On> or <Off> | |
| [High Limit] | Use the numeric keys and input. |
| [Low Limit] | Use the numeric keys and input. |
| [OFDM Symbol Power] | Press the OFDM Symbol Power soft key. |
| [Test Limits] | Press the Test Limit soft key. Toggle between On and Off . |
| <On> or <Off> | |
| [High Limit] | Use the numeric keys and input. |
| [Low Limit] | Use the numeric keys and input. |
| [Frame Avg Power] | Press the Frame Avg Power soft key. |
| [Test Limits] | Press the Test Limits soft key. Toggle between On and Off . |
| <On> or <Off> | |

| | |
|---|---|
| <p>[High Limit] [Low Limit]</p> <p>[IQ Origin Offset] [Test Limit] <On> or <Off> [High Limit]</p> | <p>Use the numeric keys to input value. Use the numeric keys to input value.</p> <p>Press the IQ Origin Offset soft key. Press the Test Limit soft key. Toggle between On and Off. Use the numeric keys and input a number in dB.</p> |
| <p>2. Enable beep LIMIT [Beep] <On> or <Off></p> | <p>Press the LIMIT hot key. Press the Beep soft key to toggle between On and Off and select one. This will make audible alarm if the measurement result goes beyond the limit.</p> |

- n **FREQUENCY ERROR:** Sets the frequency error limit.
- Y **TEST LIMITS:** Enables or disables the test limits. Toggle this soft key between **On** and **Off**.
- Y **HIGH LIMIT:** Sets the upper limit. Use the numeric keys to input value and press the unit soft key or the **ENTER** hard key to complete the input.
- Y **LOW LIMIT:** Sets the lower limit. Use the numeric keys to input value and press the unit soft key or the **ENTER** hard key to complete the input.
- n **EVM:** Sets limits for Error Vector Magnitude.
 - Y **PDSCH EVM:** *This key is not used in the Frame mode.*
 - Y **DATA EVM RMS:** Sets the rms limit of the Data EVM.
 - **TEST LIMITS:** Enables or disables the test limit. Toggle this soft key between **On** and **Off**.
 - **HIGH LIMIT:** Sets the upper limit. Use the numeric keys to input value and press the unit soft key or the **ENTER** hard key to complete the input.
 - Y **DATA EVM PEAK:** Sets the peak limit of the Data EVM.
 - **TEST LIMITS:** Enables or disables the test limit. Toggle this soft key between **On** and **Off**.
 - **HIGH LIMIT:** Sets the upper limit. Use the numeric keys to input value and press the unit soft key or the **ENTER** hard key to complete the input.
 - Y **RS EVM:** Sets the RS EVM.
 - **TEST LIMITS:** Enables or disables the test limits. Toggle this soft key between **On** and **Off**.
 - **HIGH LIMIT:** Sets the upper limit. Use the numeric keys to input value and press the unit soft key or the **ENTER** hard key to complete the input.

- Y **P-SS EVM:** *This key is not used in the Frame mode.*
- Y **S-SS EVM:** *This key is not used in the Frame mode.*
- n **POWER:** Set power limits.
 - Y **DL RS POWER:** Sets the Downlink RS power limit.
 - **TEST LIMITS:** Enables or disables the test limits. Toggle this soft key between **On** and **Off**.
 - **HIGH LIMIT:** Sets the upper limit. Use the numeric keys to input value and press the unit soft key or the **ENTER** hard key to complete the input.
 - **LOW LIMIT:** Sets the lower limit. Use the numeric keys to input value and press the unit soft key or the **ENTER** hard key to complete the input.
 - Y **P-SS POWER:** Sets the P-SS power limit.
 - **TEST LIMITS:** Enables or disables the test limits. Toggle this soft key between **On** and **Off**.
 - **HIGH LIMIT:** Sets the upper limit. Use the numeric keys to input value and press the unit soft key or the **ENTER** hard key to complete the input.
 - **LOW LIMIT:** Sets the lower limit. Use the numeric keys to input value and press the unit soft key or the **ENTER** hard key to complete the input.
 - Y **S-SS POWER:** Sets the S-SS power limit.
 - **TEST LIMITS:** Enables or disables the test limits. Toggle this soft key between **On** and **Off**.
 - **HIGH LIMIT:** Sets the upper limit. Use the numeric keys to input value and press the unit soft key or the **ENTER** hard key to complete the input.
 - **LOW LIMIT:** Sets the lower limit. Use the numeric keys to input value and press the unit soft key or the **ENTER** hard key to complete the input.
 - Y **PBCH POWER:** Sets the PBCH power limit.
 - **TEST LIMITS:** Enables or disables the test limits. Toggle this soft key between **On** and **Off**.
 - **HIGH LIMIT:** Sets the upper limit. Use the numeric keys to input value and press the unit soft key or the **ENTER** hard key to complete the input.
 - **LOW LIMIT:** Sets the lower limit. Use the numeric keys to input value and press the unit soft key or the **ENTER** hard key to complete the input.
 - Y **SUBFRAME POWER:** *This key is not used in the Frame mode.*
 - Y **OFDM SYMBOL POWER:** Sets the OFDM symbol power limit.

- **TEST LIMITS:** Enables or disables the test limits. Toggle this soft key between **On** and **Off**.
 - **HIGH LIMIT:** Sets the upper limit. Use the numeric keys to input value and press the unit soft key or the **ENTER** hard key to complete the input.
 - **LOW LIMIT:** Sets the lower limit. Use the numeric keys to input value and press the unit soft key or the **ENTER** hard key to complete the input.
- Y **FRAME AVG POWER:** Sets the frame average power limit.
- **TEST LIMITS:** Enables or disables the test limits. Toggle this soft key between **On** and **Off**.
 - **HIGH LIMIT:** Sets the upper limit. Use the numeric keys to input value and press the unit soft key or the **ENTER** hard key to complete the input.
 - **LOW LIMIT:** Sets the lower limit. Use the numeric keys to input value and press the unit soft key or the **ENTER** hard key to complete the input.
- n **TIME ALIGNMENT ERROR:** *This key is not used in the Frame mode.*
- n **TIME ERROR:** *This key is not used in the Frame mode.*
- n **IQ ORIGIN OFFSET:** Sets the limit of I/Q origin offset.
- Y **TEST LIMIT:** Enables or disables the test limit. Toggle this soft key between **On** and **Off**.
- Y **HIGH LIMIT:** Sets the upper limit. Use the numeric keys to input value and press the unit soft key or the **ENTER** hard key to complete the input.

Measurement Example

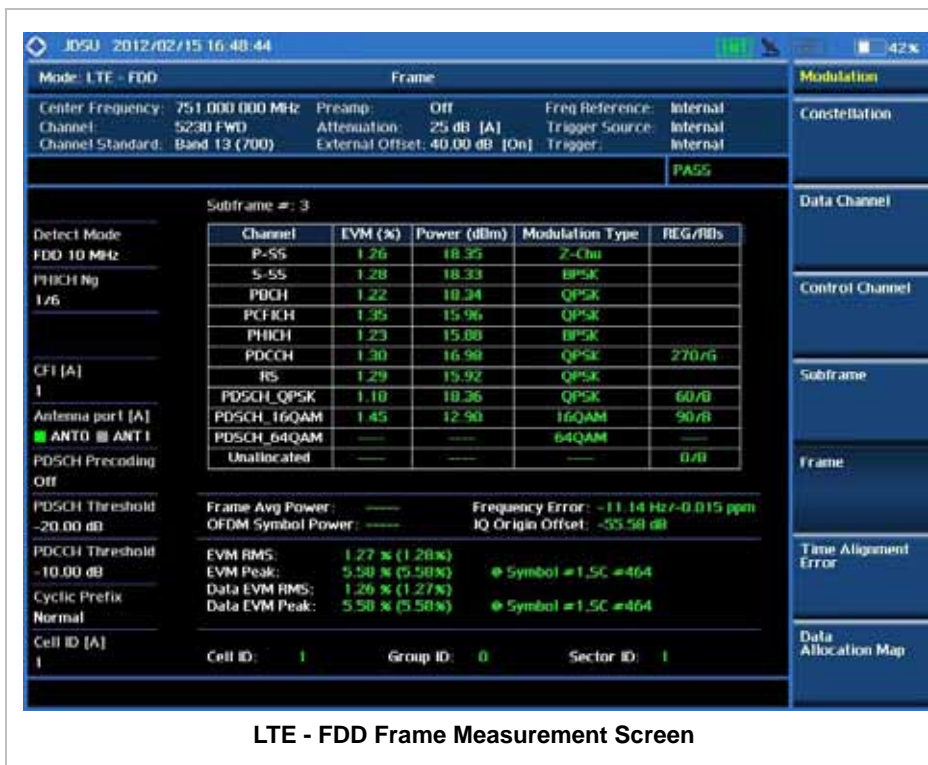

LTE - FDD Frame Measurement Screen

TIME ALIGNMENT ERROR

In eNode B supporting Tx Diversity transmission, signals are transmitted from two or more antennas. These signals shall be aligned. The time alignment error in Tx Diversity is specified as the delay between the signals from two antennas at the antenna ports.

Measurement Procedure

| Step | Description |
|--|---|
| 1. Set the measurement mode MEASURE [Modulation Analysis] [Time Alignment Error] | Press the MEASURE hot key. Press the Modulation Analysis soft key. Press the Time Alignment Error soft key. |
| 2. Set the measurement parameters MEASURE SETUP [Bandwidth] [1.4 MHz], [3 MHz], [5 MHz], [10 MHz], [15 MHz], or [20 MHz] [Cell ID] | Press the MEASURE SETUP hot key. Press the Bandwidth soft key. Press one of the soft keys to select. Press the Cell ID soft key. Toggle between Auto and |

| | |
|---|--|
| <p><Auto> or <Manual> Enter a value [Enter]</p> | <p>Manual. Use the numeric keys to set the Cell ID manually. Press the Enter soft key.</p> |
|---|--|

LTE - FDD Time Alignment Error Measurement Procedure

MEASURE SETUP 

- n **BANDWIDTH:** Selects the nominal channel bandwidth to be measured among **1.4 MHz, 3 MHz, 5 MHz, 10 MHz, 15 MHz, and 20 MHz.**
- n **CELL ID:** Enables or disables automatic detection of the Cell ID of the transmitted LTE signal. Manually setting the Cell ID to a specific one can speed up to get synchronization with BTS.
 - Y **AUTO:** Detects the Cell ID automatically.
 - Y **MANUAL:** Sets the Cell ID to a specific one.
- n **MISCELLANEOUS**
 - Y **CYCLIC PREFIX:** Sets the cyclic prefix to **Normal** or **Extended**. For OFDM parameter details by different bandwidth, refer to the table in the Appendix E – Cyclic Prefix Table.

Setting Limit

LIMIT 

This hot key is used to set the threshold value for the limit line on the display screen. It turns on or off the limit or band limit settings of the measurement for pass/fail indication. The user input window must be inactive first to get the Limit hot key function other than the number input.

| Step | Description |
|--|---|
| <p>1. Select the limit</p> <p>LIMIT</p> <p>[Modulation Test Limits]</p> <p>[Time Alignment Error]</p> <p>[Test Limits]</p> <p><On> or <Off></p> <p>[High Limit]</p> <p>[EVM]</p> <p>[RS EVM]</p> <p>[Test Limits]</p> <p><On> or <Off></p> <p>[High Limit]</p> | <p>Press the LIMIT hot key.</p> <p>Press the Modulation Test Limits soft key.</p> <p>Press the Time Alignment Error soft key.</p> <p>Press the Test Limits soft key. Toggle between On and Off.</p> <p>Use the numeric keys to input value.</p> <p>Press the EVM soft key.</p> <p>Press the RS EVM soft key.</p> <p>Press the Test Limits soft key. Toggle between On and Off.</p> <p>Use the numeric keys and input.</p> |

| | |
|---|--|
| <p>[Power] [DL RS Power] [Test Limits] <On> or <Off> [High Limit] [Low Limit]</p> | <p>Press the Power soft key. Press the DL RS Power soft key. Press the Test Limits soft key. Toggle between On and Off. Use the numeric keys and input. Use the numeric keys and input.</p> |
| <p>2. Enable beep LIMIT [Beep] <On> or <Off></p> | <p>Press the LIMIT hot key. Press the Beep soft key to toggle between On and Off and select one. This will make audible alarm if the measurement result goes beyond the limit.</p> |

- n **FREQUENCY ERROR:** *This key is not used in the Time Alignment Error mode.*
- n **EVM:** Sets limits for Error Vector Magnitude.
 - Y **PDSCH EVM:** *This key is not used in the Time Alignment Error mode.*
 - Y **DATA EVM RMS:** *This key is not used in the Time Alignment Error mode.*
 - Y **DATA EVM PEAK:** *This key is not used in the Time Alignment Error mode.*
 - Y **RS EVM:** Sets the RS EVM.
 - **TEST LIMITS:** Enables or disables the test limits. Toggle this key between **On** and **Off**.
 - **HIGH LIMIT:** Sets the upper limit. Use the numeric keys to input value and press the unit soft key or the **ENTER** hard key to complete the input.
 - Y **P-SS EVM:** *This key is not used in the Time Alignment Error mode.*
 - Y **S-SS EVM:** *This key is not used in the Time Alignment Error mode.*
- n **POWER:** Set power limits.
 - Y **DL RS POWER:** Sets the Downlink RS power limit.
 - **TEST LIMITS:** Enables or disables the test limits. Toggle this key between **On** and **Off**.
 - **HIGH LIMIT:** Sets the upper limit. Use the numeric keys to input value and press the unit soft key or the **ENTER** hard key to complete the input.
 - **LOW LIMIT:** Sets the lower limit. Use the numeric keys to input value and press the unit soft key or the **ENTER** hard key to complete the input.
 - Y **P-SS POWER:** *This key is not used in the Time Alignment Error mode.*
 - Y **S-SS POWER:** *This key is not used in the Time Alignment Error mode.*
 - Y **PBCH POWER:** *This key is not used in the Time Alignment Error mode.*

- Y **SUBFRAME POWER:** This key is not used in the Time Alignment Error mode.
- Y **OFDM SYMBOL POWER:** This key is not used in the Time Alignment Error mode.
- Y **FRAME AVG POWER:** This key is not used in the Time Alignment Error mode.
- n **TIME ALIGNMENT ERROR:** Sets the limit of time alignment error.
- Y **TEST LIMIT:** Enables or disables the test limit. Toggle this soft key between **On** and **Off**.
- Y **HIGH LIMIT:** Sets the upper limit. Use the numeric keys to input value and press the unit soft key or the **ENTER** hard key to complete the input.
- n **TIME ERROR:** This key is not used in the Time Alignment Error mode.
- n **IQ ORIGIN OFFSET:** This key is not used in the Time Alignment Error mode.

Measurement Example

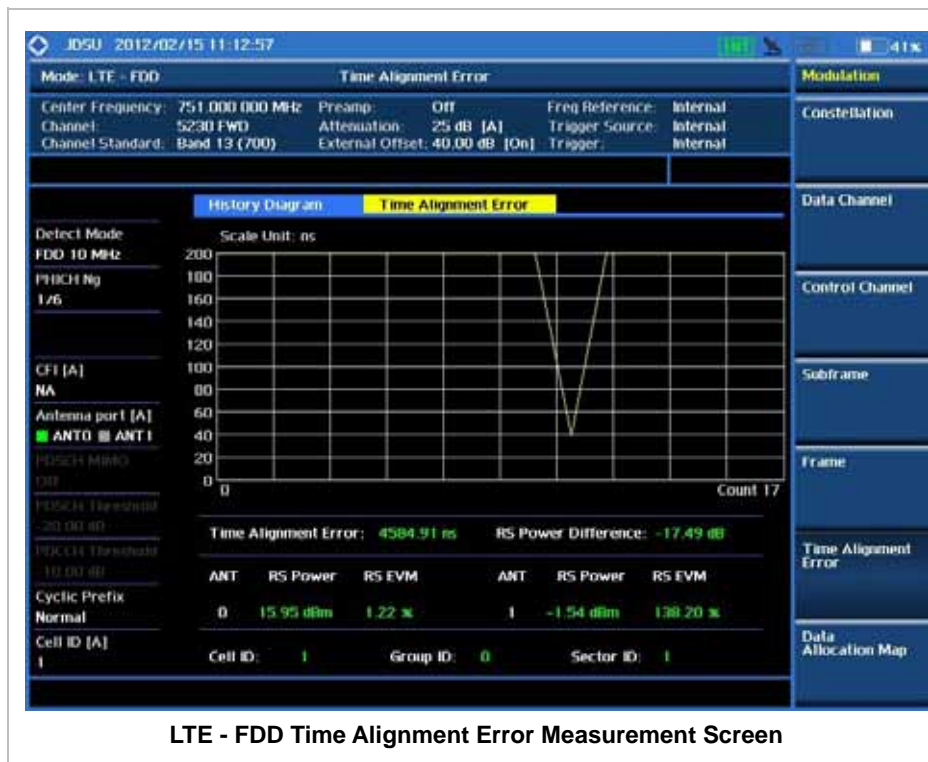

DATA ALLOCATION MAP

The Data Allocation Map function represents data allocation as a mapping.

Measurement Procedure

| Step | Description |
|--|---|
| 1. Set the measurement mode MEASURE [Modulation Analysis] [Data Allocation Map] | Press the MEASURE hot key. Press the Modulation Analysis soft key. Press the Data Allocation Map soft key. |
| 2. Set the measurement parameters MEASURE SETUP [Bandwidth] [1.4 MHz], [3 MHz], [5 MHz], [10 MHz], [15 MHz], or [20 MHz] [Subframe No] Enter a value [Enter] [PDSCH Threshold] Enter a value [dB] or ENTER [Cell ID] <Auto> or <Manual> Enter a value [Enter] | Press the MEASURE SETUP hot key. Press the Bandwidth soft key. Press one of the soft keys to select. Press the Subframe No soft key. Use the numeric keys to input value. Press the Enter soft key to complete the input. Press the PDSCH Threshold soft key. Use the numeric keys to input value. Press the unit soft key or the ENTER hard key to complete the input. Press the Cell ID soft key. Toggle between Auto and Manual . Use the numeric keys to set the Cell ID manually. Press the Enter soft key. |

LTE - FDD Data Allocation Map Measurement Procedure

MEASURE SETUP



- n **BANDWIDTH:** Selects the nominal channel bandwidth to be measured among **1.4 MHz, 3 MHz, 5 MHz, 10 MHz, 15 MHz, and 20 MHz**.
- n **SUBFRAME NO:** Sets the subframe number to be measured.
- n **PDSCH THRESHOLD:** Sets the PDSCH threshold.
- n **CELL ID:** Enables or disables automatic detection of the Cell ID of the transmitted LTE signal. Manually setting the Cell ID to a specific one can speed up to get synchronization with BTS.
 - Y **AUTO:** Detects the Cell ID automatically.
 - Y **MANUAL:** Sets the Cell ID to a specific one.

n MISCELLANEOUS

- Y **ANTENNA PORT:** Sets the antenna port number automatically or manually. Each time this soft key is pressed, selection changes among **Auto**, **0**, and **1**.
- Y **CYCLIC PREFIX:** Sets the cyclic prefix to **Normal** or **Extended**. For OFDM parameter details by different bandwidth, refer to the table in the Appendix E – Cyclic Prefix Table.

Measurement Example

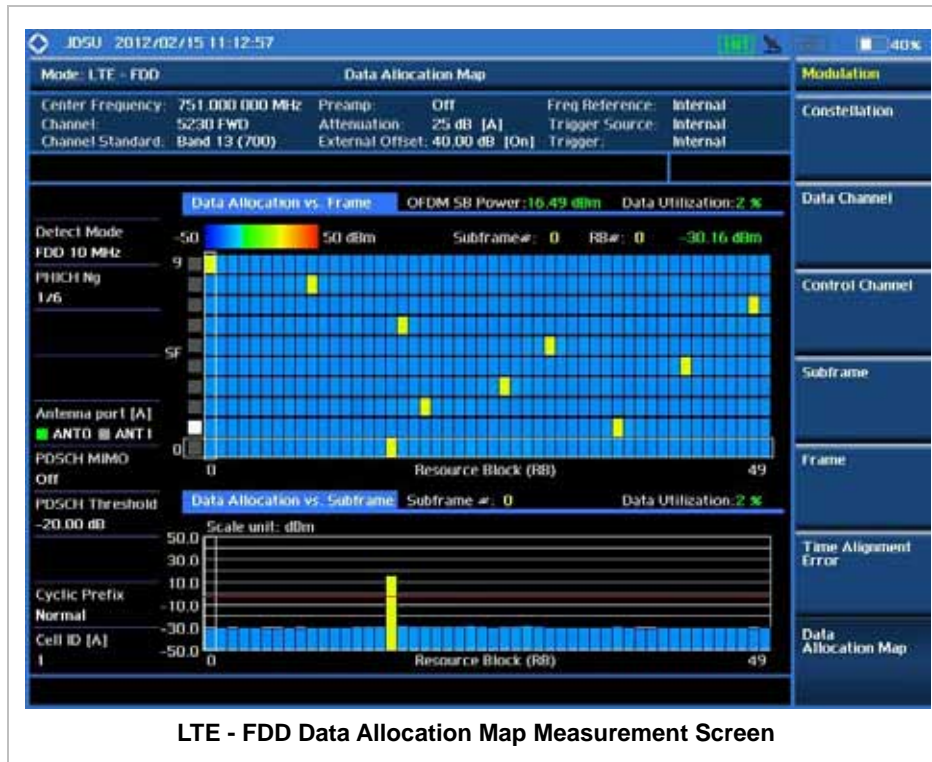

Using Marker

MARKER



- n **MARKER VIEW:** IQ Diagram operates based on the resource block designated by marker. Enable or disable the IQ diagram display on the screen by toggling this soft key between **On** and **Off**.
- n **RB NUMBER:** Sets the resource block (RB) number to be displayed. Press this soft key and use the rotary knob to move the resource block back and forth. Or use the numeric keys to enter a value and then press the **Enter** soft key to complete the input.
- n **SUBFRAME NO:** Sets the subframe number to be displayed. Press this soft key and use the rotary knob to move the selected subframe up and down. Or use the numeric keys to enter a value and then press the **Enter** soft key to complete the input.

AUTO MEASUREMENTS

The Auto Measure can be easily executed either by selecting a menu in the instrument or by running a programmed scenario in the PC-based application so that the instrument can automatically configure and perform tests in every aspect of all the carriers.

The Auto Measure in LTE - FDD Signal Analyzer provides single-button measurements for the following measurements.

- n Conformance Test
- n Maintenance Test
- n Signal Performance Test

Setting Mode

| Step | Description |
|--|--|
| 1. Connect the cable | Connect a cable directly or indirectly as shown in the section Connecting a Cable on page 8 of this chapter. |
| 2. Select the mode MODE [Signal Analyzer] [LTE - FDD] [Auto Measure] [Conformance Test], [Maintenance Test], or [Signal Performance] | Press the MODE hard key. Press the Signal Analyzer soft key. Press the LTE - FDD soft key. Press the Auto Measure soft key. Press one of the measurement mode soft keys to select. |

Setting Trigger Source

TRIGGER 

This hot key is used to select the trigger source among **Internal**, **External**, and **GPS**. The user input window must be inactive first to get the Trigger hot key function other than the number input.

Setting External Clock

To enhance the reliability of modulation analysis measurements the JD740A series must be

synchronized with the Base Station. When an external clock is not supplied, the JD740A series works with a built-in internal high-accuracy time base. In this case, some measurement results may exhibit inaccurate values. Therefore, it is highly recommended to use the same reference clock as signal source. Trigger mode can be changed by using the **TRIGGER** hot key.

EXTERNAL CLOCK OPERATING STANDARDS

| Clock | Type | Reference | Port | Switching Standard |
|--------------------|----------|--------------------|---------------|--|
| External Reference | Internal | Internal 10 MHz | | Default |
| | External | External Ref Clock | Ext Ref (SMA) | Manual switching (Input signal level >-3 dBm) |
| | GPS | GPS Clock | GPS (SMA) | Automatic switching (GPS signal received) |
| Trigger | Internal | Internal Trigger | | Default |
| | External | External Trigger | Trigger (SMA) | Manual switching |
| | GPS | GPS | GPS (SMA) | Manual switching |

CONNECTION

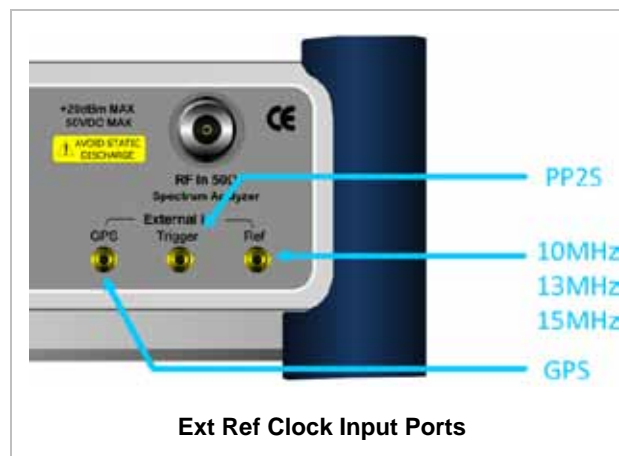



ENABLING EXTERNAL REFERENCE

| Step | Description |
|--|--|
| 1. Connect an external reference | Connect one of the external references or a GPS antenna to the JD740A series. |
| 2. Change reference clock SYSTEM [Frequency Reference] | Press the SYSTEM hot key. Press the Frequency Reference soft key to select one of the external reference clocks or GPS. |

| | |
|---|---|
| <p>[External 10 MHz], [External 13 MHz], [External 15 MHz] or [GPS]</p> | <p>Press one of the soft keys to choose among External 10 MHz, External 13 MHz, External 15 MHz, and GPS.</p> |
|---|---|

EXTERNAL REFERENCE INDICATOR INFORMATION

Each indicator tells different locking status according to a connection. When a GPS antenna is connected, longitude and latitude information will be displayed on the screen.

| Type | Indicator | Description |
|----------|--|----------------------------------|
| Internal |  (Green) | Locked |
| External |  (Green) | Locked |
| |  (Red) | Unlocked |
| GPS |  (Green) | Locked |
| |  (Yellow) | Locking in progress |
| |  (Gray) | Unable to lock or antenna failed |

CONFORMANCE TEST

The Conformance Test is to test if eNode-B meets some specified standards that have been developed for verification. Its test procedure and test setups have been developed by 3GPP. Test results can be saved as a *.csv file format.

Setting Limit



This hot key is used to set the threshold value for the limit line on the display screen. It turns on or off the limit or band limit settings of the measurement for pass/fail indication. The user input window must be inactive first to get the Limit hot key function other than the number input.

Each of the test items can be determined whether it will be tested or not in this Limit menu.

| Step | Description |
|--|---|
| <p>1. Set the test limit</p> <p>LIMIT</p> <p>[BTS Output Power]</p> <p>[Test Limits]</p> <p><On> or <Off></p> <p>[High Limit]</p> <p>Enter a value</p> <p>[dBm] or ENTER</p> <p>[Low Limit]</p> <p>Enter a value</p> <p>[dBm] or ENTER</p> <p>[Total Power Dynamic]</p> <p>[Test Limits]</p> <p><On> or <Off></p> <p>[Low Limit]</p> <p>Enter a value</p> <p>[dB] or ENTER</p> <p>[Signal Quality]</p> <p>[Frequency Error]</p> <p>[Test Limits]</p> <p><On> or <Off></p> <p>[High Limit]</p> <p>[Low Limit]</p> <p>[EVM]</p> <p>[Test Limits]</p> <p><On> or <Off></p> <p>[High Limit (QPSK)]</p> <p>[High Limit (16QAM)]</p> <p>[High Limit (64QAM)]</p> <p>[Time Alignment Error]</p> <p>[Test Limits]</p> <p><On> or <Off></p> <p>[High Limit]</p> <p>[RS Power]</p> <p>[Test Limits]</p> <p><On> or <Off></p> <p>[High Limit]</p> <p>[Low Limit]</p> | <p>Press the LIMIT hot key.</p> <p>Press the BTS Output Power soft key.</p> <p>Press the Test Limits soft key to toggle between On and Off and select one.</p> <p>Press the High Limit soft key to set the upper limit of the Pass/Fail criteria. Use the numeric keys to input value.</p> <p>Press the unit soft key or the ENTER hard key.</p> <p>Press the Low Limit soft key to set the lower limit of the Pass/Fail criteria. Use the numeric keys to input value.</p> <p>Press the unit soft key or the ENTER hard key.</p> <p>Press the Total Power Dynamic soft key.</p> <p>Press the Test Limits soft key to toggle between On and Off and select one.</p> <p>Press the Low Limit soft key to set the lower limit of the Pass/Fail criteria. Use the numeric keys to input value.</p> <p>Press the unit soft key or the ENTER hard key.</p> <p>Press the Signal Quality soft key.</p> <p>Press the Frequency Error soft key.</p> <p>Press the Test Limits soft key. Toggle between On and Off.</p> <p>Use the numeric keys to input value.</p> <p>Use the numeric keys to input value.</p> <p>Press the EVM soft key.</p> <p>Press the Test Limits soft key. Toggle between On and Off.</p> <p>Press the High Limit soft key to input value.</p> <p>Press the Time Alignment Error soft key.</p> <p>Press the Test Limits soft key. Toggle between On and Off.</p> <p>Use the numeric keys to input value.</p> <p>Press the RS Power soft key.</p> <p>Press the Test Limits soft key. Toggle between On and Off.</p> <p>Use the numeric keys and input.</p> <p>Use the numeric keys and input.</p> |

| | |
|--|--|
| <p>[Unwanted Emissions] [Occupied BW] [Test Limit] <On> or <Off> [High Limit] Enter a value [MHz], [kHz], or [Hz]</p> | <p>Press the Unwanted Emissions soft key. Press the Occupied BW soft key. Press the Test Limit soft key to toggle between On and Off and select one. Press the High Limit soft key to set the upper limit of the Pass/Fail criteria. Use the numeric keys to input value. Press the unit soft key to select.</p> |
| <p>[ACLR] [Test Limit] <On> or <Off></p> | <p>Press the ACLR soft key. Press the Test Limit soft key to toggle between On and Off and select one.</p> |
| <p>[Spectrum Emission Mask] [Test Limit] <On> or <Off> [Mask Type] [Wide Area BS Category A], [Wide Area BS Category B], [Local Area BS], or [Home BS]</p> | <p>Press the Spectrum Emission Mask soft key. Press the Test Limit soft key to toggle between On and Off and select one. Press the Mask Type soft key. Press one of the soft keys to select.</p> |
| <p>[Spurious Emissions] [Test Limit] <On> or <Off> [Range Table] [Range] Enter a value [Enter] [Start Frequency] Enter a value [GHz], [MHz], [kHz], or [Hz] [Stop Frequency] Enter a value [GHz], [MHz], [kHz], or [Hz] [Start Limit] Enter a value [dBm] [Stop Limit] Enter a value [dBm] [Attenuation] Enter a value</p> | <p>Press the Spurious Emissions soft key. Press the Test Limit soft key to toggle between On and Off and select one. Press the Range Table soft key. Press the Range soft key. Use the numeric keys to select the range number. Press the Enter soft key. Press the Start Frequency soft key. Use the numeric keys. Press one of the unit soft keys to select. Press the Stop Frequency soft key. Use the numeric keys. Press one of the unit soft keys to select. Press the Start Limit soft key. Use the numeric keys. Press the unit soft key to complete the input. Press the Stop Limit soft key. Use the numeric keys. Press the unit soft key to complete the input. Press the Attenuation soft key. Use the numeric keys to enter input value in the multiple of 5.</p> |

| | |
|---|--|
| <p>[dB] or ENTER</p> <p>[RBW]</p> <p>Enter a value</p> <p>[GHz], [MHz], [kHz], or [Hz]</p> <p>[VBW]</p> <p>Enter a value</p> <p>[GHz], [MHz], [kHz], or [Hz]</p> | <p>Press the dB unit soft key or the ENTER hard key.</p> <p>Press the RBW soft key.</p> <p>Use the numeric keys.</p> <p>Press one of the unit soft keys to select.</p> <p>Press the VBW soft key.</p> <p>Use the numeric keys.</p> <p>Press one of the unit soft keys to select.</p> |
| <p>2. Enable beep</p> <p>LIMIT</p> <p>[Beep]</p> <p><On> or <Off></p> | <p>Press the LIMIT hot key.</p> <p>Press the Beep soft key to toggle between On and Off and select one. This will make audible alarm if the measurement result goes beyond the limit.</p> |

- n **BTS OUTPUT POWER:** Sets the BTS output power test limit parameters.
 - Y **TEST LIMITS:** Enables or disables Pass/Fail results on the display screen. Toggle the **Test Limits** soft key to set it to **On** or **Off**.
 - Y **HIGH LIMIT:** Sets the upper limit of the Pass/Fail criteria. Use the numeric keys to enter a threshold or limit value and press the **dBm** unit soft key or the **ENTER** hard key to complete the input.
 - Y **LOW LIMIT:** Sets the lower limit of the Pass/Fail criteria. Use the numeric keys to enter a threshold or limit value and press the **dBm** unit soft key or the **ENTER** hard key to complete the input.
- n **TOTAL POWER DYNAMIC:** Sets the total power dynamic test limit parameters.
 - Y **TEST LIMITS:** Enables or disables Pass/Fail results on the display screen. Toggle the **Test Limits** soft key to set it to **On** or **Off**.
 - Y **LOW LIMIT:** Sets the lower limit of the Pass/Fail criteria. Use the numeric keys to enter a threshold or limit value and press the **dB** unit soft key or the **ENTER** hard key to complete the input.
- n **SIGNAL QUALITY:** Sets the test limit parameters to verify signal quality.
 - Y **FREQUENCY ERROR:** Sets the frequency error limit.
 - **TEST LIMITS:** Enables or disables the test limits. Toggle this soft key between **On** and **Off**.
 - **HIGH LIMIT:** Sets the upper limit. Use the numeric keys to input value and press the unit soft key or the **ENTER** hard key to complete the input.
 - **LOW LIMIT:** Sets the lower limit. Use the numeric keys to input value and press the unit soft key or the **ENTER** hard key to complete the input.

Y **EVM:** Sets the Error Vector Magnitude limit.

- **TEST LIMITS:** Enables or disables the test limit. Toggle this soft key between **On** and **Off**.
- **HIGH LIMIT (QPSK):** Sets the upper limit of QPSK. Use the numeric keys to input value and press the unit soft key or the **ENTER** hard key to complete the input.
- **HIGH LIMIT (16QAM):** Sets the upper limit of 16QAM. Use the numeric keys to input value and press the unit soft key or the **ENTER** hard key to complete the input.
- **HIGH LIMIT (64QAM):** Sets the upper limit of 64QAM. Use the numeric keys to input value and press the unit soft key or the **ENTER** hard key to complete the input.

Y **TIME ALIGNMENT ERROR:** Sets the limit of time alignment error.

- **TEST LIMIT:** Enables or disables the test limit. Toggle this soft key between **On** and **Off**.
- **HIGH LIMIT:** Sets the upper limit. Use the numeric keys to input value and press the unit soft key or the **ENTER** hard key to complete the input.

Y **RS POWER:** Sets the RS power limit.

- **TEST LIMITS:** Enables or disables the test limits. Toggle this soft key between **On** and **Off**.
- **HIGH LIMIT:** Sets the upper limit. Use the numeric keys to input value and press the unit soft key or the **ENTER** hard key to complete the input.
- **LOW LIMIT:** Sets the lower limit. Use the numeric keys to input value and press the unit soft key or the **ENTER** hard key to complete the input.

n UNWANTED EMISSIONS

Y **OCCUPIED BW:** Sets the test limit parameters.

- **TEST LIMIT:** Enables or disables Pass/Fail results on the display screen. Toggle the **Test Limit** soft key to set it to **On** or **Off**.
- **HIGH LIMIT:** Sets the upper limit of the Pass/Fail criteria. Use the numeric keys to enter a threshold or limit value and press one of the unit soft keys to complete the input.

Y **ACLR:** Sets the test limit parameter.

- **TEST LIMIT:** Enables or disables Pass/Fail results on the display screen. Toggle the **Test Limit** soft key to set it to **On** or **Off**.

Y **SPECTRUM EMISSION MASK:** Sets the test limit parameter.

- **TEST LIMIT:** Enables or disables Pass/Fail results on the display screen. Toggle the **Test Limit** soft key to set it to **On** or **Off**.
- **MASK TYPE:** Selects the mask type among Wide Area BS Category A, Wide Area BS

Category B, Local Area BS, and Home BS.

Y **SPURIOUS EMISSIONS:** Sets the test limit parameter.

- **TEST LIMIT:** Enables or disables Pass/Fail results on the display screen. Toggle the **Test Limit** soft key to set it to **On** or **Off**.
- **RANGE TABLE:** Sets the range table parameters.
 - o **RANGE:** Adds a new range number or selects one of the existing range numbers to show or hide the particular frequency range in the range table at the bottom of the screen. Use the numeric keys to enter a range number and press the **Enter** soft key to complete the input. Each time the **Range** soft key is press, it toggles between **On** and **Off**.
 - o **START FREQUENCY:** Sets or changes the start frequency value to be measured for the selected range number in the Range menu. Use the numeric keys to enter a value and press one of the unit soft keys.
 - o **STOP FREQUENCY:** Sets or changes the stop frequency value to be measured for the selected range number in the Range menu. Use the numeric keys to enter a value and press one of the unit soft keys.
 - o **START LIMIT:** Sets the start value of the limit line for the displayed range.
 - o **STOP LIMIT:** Sets the stop value of the limit line for the displayed range.
 - o **ATTENUATION:** Sets the attenuation value in the multiple of 5.
 - o **RBW:** Sets the resolution bandwidth for the selected range number in the Range menu.
 - o **VBW:** Sets the video bandwidth for the selected range number in the Range menu.

Measurement Procedure

| Step | Description |
|---|---|
| 1. Select the mode MEASURE [Auto Measure] [Conformance Test] | Press the MEASURE hot key. Press the Auto Measure soft key. Press the Conformance Test soft key. |
| 2. Set the measurement parameters MEASURE SETUP [Bandwidth] [1.4 MHz], [3 MHz], [5 MHz], [10 MHz], [15 MHz], or [20 MHz] | Press the MEASURE SETUP hot key. Press the Bandwidth soft key. Press one of the soft keys to select. |

| | |
|---|---|
| <p>[Freq/Channel] [Unit] <Freq> or <Channel></p> | <p>Press the Freq/Channel soft key. Press the Unit soft key. Toggle this key between Freq and Channel. A set of Freq/Dist screen menu changes accordingly.</p> |
| <p><i>When Freq is selected:</i> [Center Frequency] Enter a value [GHz], [MHz], [kHz], or [Hz]</p> | <p>Press the Center Frequency soft key. Use the numeric keys, the rotary knob, or the arrow keys. When using the numeric keys, the input is completed by selecting one of the unit soft keys.</p> |
| <p><i>When Channel is selected:</i> [Channel Standard] Select a channel standard [Select] or ENTER</p> | <p>Press the Channel Standard soft key. If this channel standard shows its default setting Band Global, go set the channel number directly. Press the arrow keys, rotate the knob, or press the Page Up and Page Down soft keys to highlight a frequency band to select. Press the Select soft key or the ENTER hard key.</p> |
| <p>[Channel Number] Enter a value [Forward]</p> | <p>Press the Channel Number soft key. Use the numeric keys to input value and press the Forward soft key to complete the input. The instrument automatically displays its corresponding center frequency value for the channel number.</p> |
| <p>[Sector] <Alpha>, <Beta>, or <Gamma></p> | <p>Press the Sector soft key. Each time this key is pressed, selection changes among Alpha, Beta, and Gamma.</p> |
| <p>[Save Result] [File Name] [Save to] <Internal> or <USB> [Save Screen] <All> or <Fail></p> | <p>Press the Save Result soft key. Press the File Name soft key to assign a specific name to the test result. Press the Save to soft key to select where to save the test result. Toggle this soft key between Internal and USB. Press the Save Screen soft key to choose the save option. Toggle this soft key between All and Fail. This key is activated only when the Save to is set to USB.</p> |
| <p>[Run]</p> | <p>Press the Run soft key to run a test.</p> |

LTE - FDD Auto Measure Conformance Test Procedure

MEASURE SETUP



n **BANDWIDTH:** Selects the nominal channel bandwidth to be measured among **1.4 MHz**, **3 MHz**,

5 MHz, 10 MHz, 15 MHz, and 20 MHz.

- n **FREQ/CHANNEL:** Sets the frequency/channel to be measured.
 - Y **UNIT:** Determines the way how to set the frequency band either with standard band or custom frequency band. Toggling this key between **Freq** and **Channel** changes a set of Freq/Dist screen menu automatically. When the **Channel** is selected, the instrument sets the **Channel Standard** setting to **Band Global** as default so that the user can set the **Channel Number** directly without choosing a standard channel band from the list.
 - Y **CENTER FREQUENCY:** Changes the center frequency setting. Use the rotary knob or the arrow keys. Or use the numeric keys to input a certain value and press one of the unit soft keys to complete the input.
 - Y **FREQUENCY STEP:** Defines the amount of frequency to be increased or decreased when using the rotary knob or the arrow keys to change the **Center Frequency**. This frequency step size can be entered by using numeric keys and the unit soft keys.
 - Y **CHANNEL NUMBER:** Enters a channel number. The instrument automatically displays its corresponding center frequency value for the channel number.
 - Y **CHANNEL STEP:** Defines the amount of channel to be increased or decreased when using the rotary knob or the arrow keys to change the **Channel Number**. This channel step size can be entered by using numeric keys and the **Enter** soft key.
 - Y **CHANNEL STANDARD:** When the channel standard is selected from the list, the center frequency information on the display screen will be mapped accordingly to the selected channel standard. The channel standards available in the instrument are listed in the Appendix C – Band, Frequency & Channel Standard.
- n **SECTOR:** Sets the sector option among **Alpha**, **Beta**, and **Gamma**.
- n **EXTERNAL OFFSET:** Sets an external offset value. An offset consists of a cable loss and a user offset and the measurement result shows the value reflecting both offset values. When the external offset value is set at 40 dB in the Spectrum mode, the measurement result compensates 40 dB at both the Spectrum Analyzer and Signal Analyzer modes.
- n **SAVE RESULT:** Sets parameters for saving measurement results. The instrument automatically saves measurement results in *.CSV format as well so that they can be imported in application software that supports the CSV format.
 - Y **FILE NAME:** Sets the measurement result file name.
 - Y **SAVE TO:** Sets the destination where the result to be saved, **Internal** or **USB**.
 - Y **SAVE SCREEN:** Selects what results to be saved into a USB drive. Toggle this soft key between **All** for all the measurement items and **Fail** for failed items only. This key is activated only when the **Save to** is set to **USB**.
- n **RUN:** Starts a conformance test.

- n **ABORT:** Stops a conformance test.

MAINTENANCE TEST

The Auto Measure function of the JD740A series allows a complete signal profiling covering RF characterization and modulation quality parameters of up to 20 different carriers, particularly useful on an overlay architecture where base stations are transmitting in different frequencies.

Following settings are required only when you run the Auto Measure Maintenance Test on the instrument using “Current” configuration setting. Additional settings are not required when you run Auto Measure using a scenario generated in the PC application software, JDViewer.

Setting Frequency

| Step | Description |
|--|--|
| <p>1. Set the frequency</p> <p>FREQ/DIST</p> <p>[Unit]</p> <p><Freq> or <Channel></p> <p><i>When Freq is selected:</i></p> <p>[Center Frequency]</p> <p>Enter a value</p> <p>[GHz], [MHz], [kHz], or [Hz]</p> <p><i>When Channel is selected:</i></p> <p>[Channel Standard]</p> <p>Select a channel standard</p> <p>[Select] or ENTER</p> <p>[Channel Number]</p> <p>Enter a value</p> <p>[Forward]</p> | <p>Press the FREQ/DIST hard key.</p> <p>Press the Unit soft key. Toggle this key between Freq and Channel. A set of Freq/Dist screen menu changes accordingly.</p> <p>Press the Center Frequency soft key.</p> <p>Use the numeric keys, the rotary knob, or the arrow keys.</p> <p>When using the numeric keys, the input is completed by selecting one of the unit soft keys.</p> <p>Press the Channel Standard soft key. If this channel standard shows its default setting Band Global, go set the channel number directly.</p> <p>Press the arrow keys, rotate the knob, or press the Page Up and Page Down soft keys to highlight a frequency band to select.</p> <p>Press the Select soft key or the ENTER hard key.</p> <p>Press the Channel Number soft key.</p> <p>Use the numeric keys to input value and press the Forward soft key to complete the input. The instrument automatically</p> |

| | |
|--|---|
| | displays its corresponding center frequency value for the channel number. |
|--|---|

FREQ/DIST



- n **UNIT:** Determines the way how to set the frequency band either with standard band or custom frequency band. Toggling this key between **Freq** and **Channel** changes a set of Freq/Dist screen menu automatically. When the **Channel** is selected, the instrument sets the **Channel Standard** setting to **Band Global** as default so that the user can set the **Channel Number** directly without choosing a standard channel band from the list.
- n **CENTER FREQUENCY:** Changes the center frequency setting. Use the rotary knob or the arrow keys. Or use the numeric keys to input a certain value and press one of the unit soft keys to complete the input.
- n **FREQUENCY STEP:** Defines the amount of frequency to be increased or decreased when using the rotary knob or the arrow keys to change the **Center Frequency**. This frequency step size can be entered by using numeric keys and the unit soft keys.
- n **CHANNEL NUMBER:** Enters a channel number. The instrument automatically displays its corresponding center frequency value for the channel number.
- n **CHANNEL STEP:** Defines the amount of channel to be increased or decreased when using the rotary knob or the arrow keys to change the **Channel Number**. This channel step size can be entered by using numeric keys and the **Enter** soft key.
- n **CHANNEL STANDARD:** When the channel standard is selected from the list, the center frequency information on the display screen will be mapped accordingly to the selected channel standard. The channel standards available in the instrument are listed in the Appendix C – Band, Frequency & Channel Standard.

Setting Limit

LIMIT



This hot key is used to set the threshold value for the limit line on the display screen. It turns on or off the limit or band limit settings of the measurement for pass/fail indication. The user input window must be inactive first to get the Limit hot key function other than the number input.

| Step | Description |
|--|---------------------------------|
| 1. Set the RF test limit LIMIT | Press the LIMIT hot key. |

| | |
|--|---|
| <p>[RF Test Limits]</p> <p>[Channel Power]</p> <p>[Test Limits] <On> or <Off></p> <p>[High Limit] Enter a value [dBm] or ENTER</p> <p>[Low Limit] Enter a value [dBm] or ENTER</p> <p>[Occupied BW]</p> <p>[Test Limit] <On> or <Off></p> <p>[High Limit] Enter a value [MHz], [kHz], or [Hz]</p> <p>[Spectrum Emission Mask]</p> <p>[Test Limit] <On> or <Off></p> <p>[ACLR]</p> <p>[Test Limit] <On> or <Off></p> <p>[Multi-ACLR]</p> <p>[Test Limit] <On> or <Off></p> <p>[Spurious Emissions]</p> <p>[Test Limit] <On> or <Off></p> | <p>Press the RF Test Limits soft key.</p> <p>Press the Channel Power soft key.</p> <p>Press the Test Limits soft key to toggle between On and Off and select one.</p> <p>Press the High Limit soft key to set the upper limit of the Pass/Fail criteria. Use the numeric keys to input value.</p> <p>Press the unit soft key or the ENTER hard key.</p> <p>Press the Low Limit soft key to set the lower limit of the Pass/Fail criteria. Use the numeric keys to input value.</p> <p>Press the unit soft key or the ENTER hard key.</p> <p>Press the Occupied BW soft key.</p> <p>Press the Test Limit soft key to toggle between On and Off and select one.</p> <p>Press the High Limit soft key to set the upper limit of the Pass/Fail criteria. Use the numeric keys to input value.</p> <p>Press the unit soft key to select.</p> <p>Press the Spectrum Emission Mask soft key.</p> <p>Press the Test Limit soft key to toggle between On and Off and select one.</p> <p>Press the ACLR soft key.</p> <p>Press the Test Limit soft key to toggle between On and Off and select one.</p> <p>Press the Multi-ALPR soft key.</p> <p>Press the Test Limit soft key to toggle between On and Off and select one.</p> <p>Press the Spurious Emissions soft key.</p> <p>Press the Test Limit soft key to toggle between On and Off and select one.</p> |
| <p>2. Set the modulation test limit LIMIT</p> <p>[Modulation Test Limits]</p> <p>[Frequency Error]</p> <p>[Test Limits] <On> or <Off></p> <p>[High Limit]</p> <p>[Low Limit]</p> <p>[EVM]</p> <p>[PDSCH EVM]</p> | <p>Press the LIMIT hot key.</p> <p>Press the Modulation Test Limits soft key.</p> <p>Press the Frequency Error soft key.</p> <p>Press the Test Limits soft key. Toggle between On and Off.</p> <p>Use the numeric keys to input value.</p> <p>Use the numeric keys to input value.</p> <p>Press the EVM soft key.</p> <p>Press the PDSCH EVM soft key.</p> |

| | |
|--|--|
| <p>[Test Limits] <On> or <Off> [High Limit (QPSK)] [High Limit (16QAM)] [High Limit (64QAM)]</p> | <p>Press the Test Limits soft key. Toggle between On and Off. Press the High Limit (QPSK) soft key to input value. Press the High Limit (16QAM) soft key to input value. Press the High Limit (64QAM) soft key to input value.</p> |
| <p>[Data EVM RMS] [Test Limits] <On> or <Off> [High Limit]</p> | <p>Press the Data EVM RMS soft key. Press the Test Limits soft key. Toggle between On and Off. Press the High Limit soft key to input value.</p> |
| <p>[Data EVM Peak] [Test Limits] <On> or <Off> [High Limit]</p> | <p>Press the Data EVM Peak soft key. Press the Test Limits soft key. Toggle between On and Off. Press the High Limit soft key to input value.</p> |
| <p>[RS EVM] [Test Limits] <On> or <Off> [High Limit]</p> | <p>Press the RS EVM soft key. Press the Test Limits soft key. Toggle between On and Off. Use the numeric keys and input.</p> |
| <p>[P-SS EVM] [Test Limits] <On> or <Off> [High Limit]</p> | <p>Press the P-SS EVM soft key. Press the Test Limits soft key. Toggle between On and Off. Use the numeric keys and input.</p> |
| <p>[S-SS EVM] [Test Limits] <On> or <Off> [High Limit]</p> | <p>Press the S-SS EVM soft key. Press the Test Limits soft key. Toggle between On and Off. Use the numeric keys and input.</p> |
| <p>[Power] [DL RS Power] [Test Limit] <On> or <Off> [High Limit] [Low Limit]</p> | <p>Press the Power soft key. Press the DL RS Power soft key. Press the Test Limit soft key. Toggle between On and Off. Use the numeric keys and input. Use the numeric keys and input.</p> |
| <p>[P-SS Power] [Test Limits] <On> or <Off> [High Limit] [Low Limit]</p> | <p>Press the P-SS Power soft key. Press the Test Limit soft key. Toggle between On and Off. Use the numeric keys and input. Use the numeric keys and input.</p> |

| | |
|---|---|
| <p>[S-SS Power] [Test Limits] <On> or <Off> [High Limit] [Low Limit]</p> | <p>Press the S-SS Power soft key. Press the Test Limit soft key. Toggle between On and Off. Use the numeric keys and input. Use the numeric keys and input.</p> |
| <p>[PBCH Power] [Test Limits] <On> or <Off> [High Limit] [Low Limit]</p> | <p>Press the PBCH Power soft key. Press the Test Limit soft key. Toggle between On and Off. Use the numeric keys and input. Use the numeric keys and input.</p> |
| <p>[Subframe Power] [Test Limits] <On> or <Off> [High Limit] [Low Limit]</p> | <p>Press the Subframe Power soft key. Press the Test Limit soft key. Toggle between On and Off. Use the numeric keys and input. Use the numeric keys and input.</p> |
| <p>[OFDM Symbol Power] [Test Limits] <On> or <Off> [High Limit] [Low Limit]</p> | <p>Press the OFDM Symbol Power soft key. Press the Test Limit soft key. Toggle between On and Off. Use the numeric keys and input. Use the numeric keys and input.</p> |
| <p>[Frame Avg Power] [Test Limits] <On> or <Off> [High Limit] [Low Limit]</p> | <p>Press the Frame Avg Power soft key. Press the Test Limit soft key. Toggle between On and Off. Use the numeric keys and input. Use the numeric keys and input.</p> |
| <p>[Time Alignment Error] [Test Limits] <On> or <Off> [High Limit]</p> | <p>Press the Time Alignment Error soft key. Press the Test Limits soft key. Toggle between On and Off. Use the numeric keys to input value.</p> |
| <p>[Time Error] [Test Limits] <On> or <Off> [High Limit] [Low Limit]</p> | <p>Press the Time Error soft key. Press the Test Limits soft key. Toggle between On and Off. Use the numeric keys to input value. Use the numeric keys to input value.</p> |
| <p>[IQ Origin Offset] [Test Limit] <On> or <Off></p> | <p>Press the IQ Origin Offset soft key. Press the Test Limit soft key. Toggle between On and Off.</p> |

| | |
|---|--|
| <p>[High Limit]</p> | <p>Use the numeric keys and input a number in dB.</p> |
| <p>3. Enable beep LIMIT [Beep] <On> or <Off></p> | <p>Press the LIMIT hot key. Press the Beep soft key to toggle between On and Off and select one. This will make audible alarm if the measurement result goes beyond the limit.</p> |

- n **CHANNEL POWER:** Sets the test limit parameters.
 - Y **TEST LIMITS:** Enables or disables Pass/Fail results on the display screen. Toggle the **Test Limits** soft key to set it to **On** or **Off**.
 - Y **HIGH LIMIT:** Sets the upper limit of the Pass/Fail criteria. Use the numeric keys to enter a threshold or limit value and press the **dBm** unit soft key or the **ENTER** hard key to complete the input.
 - Y **LOW LIMIT:** Sets the lower limit of the Pass/Fail criteria. Use the numeric keys to enter a threshold or limit value and press the **dBm** unit soft key or the **ENTER** hard key to complete the input.
- n **OCCUPIED BW:** Sets the test limit parameters.
 - Y **TEST LIMIT:** Enables or disables Pass/Fail results on the display screen. Toggle the **Test Limit** soft key to set it to **On** or **Off**.
 - Y **HIGH LIMIT:** Sets the upper limit of the Pass/Fail criteria. Use the numeric keys to enter a threshold or limit value and press one of the unit soft keys to complete the input.
- n **SPECTRUM EMISSION MASK:** Sets the test limit parameter.
 - Y **TEST LIMIT:** Enables or disables Pass/Fail results on the display screen. Toggle the **Test Limit** soft key to set it to **On** or **Off**.
- n **ACLR:** Sets the test limit parameter.
 - Y **TEST LIMIT:** Enables or disables Pass/Fail results on the display screen. Toggle the **Test Limit** soft key to set it to **On** or **Off**.
- n **MULTI-ACLR:** Sets the test limit parameter.
 - Y **TEST LIMIT:** Enables or disables Pass/Fail results on the display screen. Toggle the **Test Limit** soft key to set it to **On** or **Off**.
- n **SPURIOUS EMISSIONS:** Sets the test limit parameter.
 - Y **TEST LIMIT:** Enables or disables Pass/Fail results on the display screen. Toggle the **Test Limit** soft key to set it to **On** or **Off**.
- n **FREQUENCY ERROR:** Sets the frequency error limit.

- Y **TEST LIMITS:** Enables or disables the test limits. Toggle this soft key between **On** and **Off**.
- Y **HIGH LIMIT:** Sets the upper limit. Use the numeric keys to input value and press the unit soft key or the **ENTER** hard key to complete the input.
- Y **LOW LIMIT:** Sets the lower limit. Use the numeric keys to input value and press the unit soft key or the **ENTER** hard key to complete the input.
- n **EVM:** Sets limits for Error Vector Magnitude.
 - Y **PDSCH EVM:** Sets the limit of the PDSCH EVM.
 - **TEST LIMITS:** Enables or disables the test limit. Toggle this soft key between **On** and **Off**.
 - **HIGH LIMIT (QPSK):** Sets the upper limit of QPSK. Use the numeric keys to input value and press the unit soft key or the **ENTER** hard key to complete the input.
 - **HIGH LIMIT (16QAM):** Sets the upper limit of 16QAM. Use the numeric keys to input value and press the unit soft key or the **ENTER** hard key to complete the input.
 - **HIGH LIMIT (64QAM):** Sets the upper limit of 64QAM. Use the numeric keys to input value and press the unit soft key or the **ENTER** hard key to complete the input.
 - Y **DATA EVM RMS:** Sets the rms limit of the Data EVM.
 - **TEST LIMITS:** Enables or disables the test limit. Toggle this soft key between **On** and **Off**.
 - **HIGH LIMIT:** Sets the upper limit. Use the numeric keys to input value and press the unit soft key or the **ENTER** hard key to complete the input.
 - Y **DATA EVM PEAK:** Sets the peak limit of the Data EVM.
 - **TEST LIMITS:** Enables or disables the test limit. Toggle this soft key between **On** and **Off**.
 - **HIGH LIMIT:** Sets the upper limit. Use the numeric keys to input value and press the unit soft key or the **ENTER** hard key to complete the input.
 - Y **RS EVM:** Sets the RS EVM.
 - **TEST LIMITS:** Enables or disables the test limits. Toggle this soft key between **On** and **Off**.
 - **HIGH LIMIT:** Sets the upper limit. Use the numeric keys to input value and press the unit soft key or the **ENTER** hard key to complete the input.
 - Y **P-SS EVM:** Sets the P-SS EVM.
 - **TEST LIMITS:** Enables or disables the test limits. Toggle this soft key between **On** and **Off**.

- **HIGH LIMIT:** Sets the upper limit. Use the numeric keys to input value and press the unit soft key or the **ENTER** hard key to complete the input.
- Y **S-SS EVM:** Sets the S-SS EVM.
- **TEST LIMITS:** Enables or disables the test limits. Toggle this soft key between **On** and **Off**.
 - **HIGH LIMIT:** Sets the upper limit. Use the numeric keys to input value and press the unit soft key or the **ENTER** hard key to complete the input.
- n **POWER:** Set power limits.
- Y **DL RS POWER:** Sets the Downlink RS power limit.
- **TEST LIMITS:** Enables or disables the test limits. Toggle this soft key between **On** and **Off**.
 - **HIGH LIMIT:** Sets the upper limit. Use the numeric keys to input value and press the unit soft key or the **ENTER** hard key to complete the input.
 - **LOW LIMIT:** Sets the lower limit. Use the numeric keys to input value and press the unit soft key or the **ENTER** hard key to complete the input.
- Y **P-SS POWER:** Sets the P-SS power limit.
- **TEST LIMITS:** Enables or disables the test limits. Toggle this soft key between **On** and **Off**.
 - **HIGH LIMIT:** Sets the upper limit. Use the numeric keys to input value and press the unit soft key or the **ENTER** hard key to complete the input.
 - **LOW LIMIT:** Sets the lower limit. Use the numeric keys to input value and press the unit soft key or the **ENTER** hard key to complete the input.
- Y **S-SS POWER:** Sets the S-SS power limit.
- **TEST LIMITS:** Enables or disables the test limits. Toggle this soft key between **On** and **Off**.
 - **HIGH LIMIT:** Sets the upper limit. Use the numeric keys to input value and press the unit soft key or the **ENTER** hard key to complete the input.
 - **LOW LIMIT:** Sets the lower limit. Use the numeric keys to input value and press the unit soft key or the **ENTER** hard key to complete the input.
- Y **PBCH POWER:** Sets the PBCH power limit.
- **TEST LIMITS:** Enables or disables the test limits. Toggle this soft key between **On** and **Off**.
 - **HIGH LIMIT:** Sets the upper limit. Use the numeric keys to input value and press the

unit soft key or the **ENTER** hard key to complete the input.

- **LOW LIMIT:** Sets the lower limit. Use the numeric keys to input value and press the unit soft key or the **ENTER** hard key to complete the input.

Y **SUBFRAME POWER:** Sets the subframe power limit.

- **TEST LIMITS:** Enables or disables the test limits. Toggle this soft key between **On** and **Off**.
- **HIGH LIMIT:** Sets the upper limit. Use the numeric keys to input value and press the unit soft key or the **ENTER** hard key to complete the input.
- **LOW LIMIT:** Sets the lower limit. Use the numeric keys to input value and press the unit soft key or the **ENTER** hard key to complete the input.

Y **OFDM SYMBOL POWER:** Sets the OFDM symbol power limit.

- **TEST LIMITS:** Enables or disables the test limits. Toggle this soft key between **On** and **Off**.
- **HIGH LIMIT:** Sets the upper limit. Use the numeric keys to input value and press the unit soft key or the **ENTER** hard key to complete the input.
- **LOW LIMIT:** Sets the lower limit. Use the numeric keys to input value and press the unit soft key or the **ENTER** hard key to complete the input.

Y **FRAME AVG POWER:** Sets the frame average power limit.

- **TEST LIMITS:** Enables or disables the test limits. Toggle this soft key between **On** and **Off**.
- **HIGH LIMIT:** Sets the upper limit. Use the numeric keys to input value and press the unit soft key or the **ENTER** hard key to complete the input.
- **LOW LIMIT:** Sets the lower limit. Use the numeric keys to input value and press the unit soft key or the **ENTER** hard key to complete the input.

n **TIME ALIGNMENT ERROR:** Sets the limit of time alignment error.

Y **TEST LIMIT:** Enables or disables the test limit. Toggle this soft key between **On** and **Off**.

Y **HIGH LIMIT:** Sets the upper limit. Use the numeric keys to input value and press the unit soft key or the **ENTER** hard key to complete the input.

n **TIME ERROR:** Sets the limit of the Time Error.

Y **TEST LIMITS:** Enables or disables the test limits. Toggle this soft key between **On** and **Off**.

Y **HIGH LIMIT:** Sets the upper limit. Use the numeric keys to input value and press the unit soft key or the **ENTER** hard key to complete the input.

Y **LOW LIMIT:** Sets the lower limit. Use the numeric keys to input value and press the unit soft

- key or the **ENTER** hard key to complete the input.
- n **IQ ORIGIN OFFSET:** Sets the limit of I/Q origin offset.
- Y **TEST LIMIT:** Enables or disables the test limit. Toggle this soft key between **On** and **Off**.
- Y **HIGH LIMIT:** Sets the upper limit. Use the numeric keys to input value and press the unit soft key or the **ENTER** hard key to complete the input.

Measurement Procedure

| Step | Description |
|--|--|
| 1. Select the mode MEASURE [Auto Measure] [Maintenance Test] | Press the MEASURE hot key. Press the Auto Measure soft key. Press the Maintenance Test soft key. |
| 2. Set the measurement parameters MEASURE SETUP [Configuration] <Current> or <Scenario> [Load Scenario] [Test Time] <Now> or <Schedule> [Set Timing] [Start Time (HH:MM)] Enter a value [HHMM] [Stop Time (HH:MM)] Enter a value [HHMM] [Time Interval] Enter a value [Min] [Save Result] [File Name] [Save to] | Press the MEASURE SETUP hot key. Press the Configuration soft key to select the mode. Toggle this soft key between Current and Scenario . Press the Load Scenario soft key to load a scenario file. This key is active only when the Configuration is set to Scenario . Press the Test Time soft key to select when to run a test. Toggle this soft key between Now and Schedule . Press the Set Timing soft key. This key is activated only when the Test Time is set to Schedule. Press the Start Time soft key. Use the numeric keys to input value in HH:MM format. Press the HHMM soft key to complete the input. Press the Stop Time soft key. Use the numeric keys to input value in HH:MM format. Press the HHMM soft key to complete the input. Press the Time Interval soft key. Use the numeric keys to input value in minutes. Press the Min soft key to complete the input. Press the Save Result soft key. Press the File Name soft key to assign a specific name to the test result. Press the Save to soft key to select where to save the test |

| | |
|--|--|
| <p><Internal> or <USB> [Save Screen] <All> or <Fail></p> | <p>result. Toggle this soft key between Internal and USB. Press the Save Screen soft key to choose the save option. Toggle this soft key between All and Fail. This key is activated only when the Save to is set to USB.</p> |
| <p>[Settings] [Bandwidth] [1.4 MHz], [3 MHz], [5 MHz], [10 MHz], [15 MHz], or [20 MHz] [Cell ID] <Auto> or <Manual> Enter a value [Enter] [Antenna Port] <Auto>, <0>, or <1></p> | <p>Press the Settings soft key. Press the Bandwidth soft key. Press one of the soft keys to select. Press the Cell ID soft key. Toggle between Auto and Manual. Use the numeric keys to set the Cell ID manually. Press the Enter soft key. Press the Antenna Port soft key. Each time this soft key is pressed, selection changes among Auto, 0, and 1.</p> |
| <p>[Run Test]</p> | <p>Press the Run Test soft key to run a test.</p> |

LTE - FDD Auto Measurement Maintenance Test Procedure

MEASURE SETUP 

- n **CONFIGURATION:** Selects the measurement configuration to be used. When the **Current** is selected, the instrument runs a test using current carrier frequency (single carrier) and determines pass/fail based on the instrument's limit settings. Select the **Scenario** to run a test with a programmed scenario.
- n **LOAD SCENARIO:** Selects and loads a scenario file generated by the PC application software, JDViewer. This soft key is activated only when the **Configuration** is set to **Scenario**.
- n **TEST TIME:** Selects the test time. When **Now** is selected, the instrument runs a test only once. When **Schedule** is selected, the instrument repeats tests as defined in the **Set Timing** menu.
- n **SET TIMING:** Sets the **Start Time**, **Stop Time**, and **Time Interval** of a scheduled measurement. This soft key is activated only when the **Test Time** is set to **Schedule**.
- n **SAVE RESULT:** Sets parameters for saving measurement results. The instrument automatically saves measurement results in *.CSV format as well so that they can be imported in application software that supports the CSV format.
- Y **FILE NAME:** Sets the measurement result file name.
- Y **SAVE TO:** Sets the destination where the result to be saved, **Internal** or **USB**.
- Y **SAVE SCREEN:** Selects what results to be saved into a USB drive. Toggle this soft key between **All** for all the measurement items and **Fail** for failed items only. This key is activated only when the **Save to**

is set to **USB**.

- n **SETTINGS:** Sets the Cell ID and the Antenna Port.
 - Y **BANDWIDTH:** Selects the nominal channel bandwidth to be measured among **1.4 MHz**, **3 MHz**, **5 MHz**, **10 MHz**, **15 MHz**, and **20 MHz**.
 - Y **CELL ID:** Enables or disables automatic detection of the Cell ID of the transmitted LTE signal. Manually setting the Cell ID to a specific one can speed up to get synchronization with BTS.
 - **AUTO:** Detects the Cell ID automatically.
 - **MANUAL:** Sets the Cell ID to a specific one.
 - Y **ANTENNA PORT:** Sets the antenna port number automatically or manually. Each time this soft key is pressed, selection changes among **Auto**, **0**, and **1**.
 - Y **EXTERNAL OFFSET:** Sets an external offset value. An offset consists of a cable loss and a user offset and the measurement result shows the value reflecting both offset values. When the external offset value is set at 40 dB in the Spectrum mode, the measurement result compensates 40 dB at both the Spectrum Analyzer and Signal Analyzer modes.
- n **RUN TEST:** Starts a test.

Setting Display

TRACE/DISPLAY



- n **DISPLAY:** Changes the display option. After running automatic measurement, toggle this key between **Results** and **Settings**.
 - Y **RESULTS:** Shows actual measurement results on the display screen.
 - Y **SETTINGS:** Shows measurement parameters set for the automatic measurement.
- n **DISPLAY RESULTS:** Changes the display format of measurement results. This key becomes activated when the **Results** is set as the display option. Toggle this key between **Full** and **Quick** to check measurement results in different format.
 - Y **FULL:** Shows detailed measurement results, including actual measurement readings with pass/fail color indication.
 - Y **QUICK:** Shows quick view of pass/fail results.
- n **VIEW CARRIER:** Selects a carrier to be displayed among up to 10 carriers. This key becomes activated when the **Results** is set as the display option.

SIGNAL PERFORMANCE TEST

Unlike the other measurement modes of the auto measurement, the Signal Performance Test runs measurement continuously.

Setting Frequency

| Step | Description |
|---|--|
| <p>1. Set the frequency</p> <p>FREQ/DIST</p> <p>[Unit] <Freq> or <Channel></p> <p><i>When Freq is selected:</i></p> <p>[Center Frequency] Enter a value [GHz], [MHz], [kHz], or [Hz]</p> <p><i>When Channel is selected:</i></p> <p>[Channel Standard] Select a channel standard</p> <p>[Select] or ENTER</p> <p>[Channel Number] Enter a value [Forward]</p> | <p>Press the FREQ/DIST hard key.</p> <p>Press the Unit soft key. Toggle this key between Freq and Channel. A set of Freq/Dist screen menu changes accordingly.</p> <p>Press the Center Frequency soft key. Use the numeric keys, the rotary knob, or the arrow keys. When using the numeric keys, the input is completed by selecting one of the unit soft keys.</p> <p>Press the Channel Standard soft key. If this channel standard shows its default setting Band Global, go set the channel number directly. Press the arrow keys, rotate the knob, or press the Page Up and Page Down soft keys to highlight a frequency band to select.</p> <p>Press the Select soft key or the ENTER hard key.</p> <p>Press the Channel Number soft key. Use the numeric keys to input value and press the Forward soft key to complete the input. The instrument automatically displays its corresponding center frequency value for the channel number.</p> |

FREQ/DIST



- n **UNIT:** Determines the way how to set the frequency band either with standard band or custom frequency band. Toggling this key between **Freq** and **Channel** changes a set of Freq/Dist screen menu automatically. When the **Channel** is selected, the instrument sets the **Channel Standard**

setting to **Band Global** as default so that the user can set the **Channel Number** directly without choosing a standard channel band from the list.

- n **CENTER FREQUENCY:** Changes the center frequency setting. Use the rotary knob or the arrow keys. Or use the numeric keys to input a certain value and press one of the unit soft keys to complete the input.
- n **FREQUENCY STEP:** Defines the amount of frequency to be increased or decreased when using the rotary knob or the arrow keys to change the **Center Frequency**. This frequency step size can be entered by using numeric keys and the unit soft keys.
- n **CHANNEL NUMBER:** Enters a channel number. The instrument automatically displays its corresponding center frequency value for the channel number.
- n **CHANNEL STEP:** Defines the amount of channel to be increased or decreased when using the rotary knob or the arrow keys to change the **Channel Number**. This channel step size can be entered by using numeric keys and the **Enter** soft key.
- n **CHANNEL STANDARD:** When the channel standard is selected from the list, the center frequency information on the display screen will be mapped accordingly to the selected channel standard. The channel standards available in the instrument are listed in the Appendix C – Band, Frequency & Channel Standard.

Setting Sweep Mode

SWEEP



This hot key is used to set the sweep parameters. The user input window must be inactive first to get the Sweep hot key function other than the number input.

- n **SWEEP MODE:** Sets the sweep method. Toggle between **Continue** and **Single**.

| Step | Description |
|---|---|
| 1. Set the sweep mode SWEEP [Sweep Mode] | Press the SWEEP hot key. Press the Sweep Mode soft key. Toggle between Continue and Single . |

Setting Limit

LIMIT



This hot key is used to set the threshold value for the limit line on the display screen. It turns on or off

the limit or band limit settings of the measurement for pass/fail indication. The user input window must be inactive first to get the Limit hot key function other than the number input.

| Step | Description |
|--|--|
| <p>1. Set the RF test limit</p> <p>LIMIT</p> <p>[RF Test Limits]</p> <p>[Channel Power]</p> <p>[Test Limits]</p> <p><On> or <Off></p> <p>[High Limit]</p> <p>Enter a value</p> <p>[dBm] or ENTER</p> <p>[Low Limit]</p> <p>Enter a value</p> <p>[dBm] or ENTER</p> | <p>Press the LIMIT hot key.</p> <p>Press the RF Test Limits soft key.</p> <p>Press the Channel Power soft key.</p> <p>Press the Test Limits soft key to toggle between On and Off and select one.</p> <p>Press the High Limit soft key to set the upper limit of the Pass/Fail criteria. Use the numeric keys to input value.</p> <p>Press the unit soft key or the ENTER hard key.</p> <p>Press the Low Limit soft key to set the lower limit of the Pass/Fail criteria. Use the numeric keys to input value.</p> <p>Press the unit soft key or the ENTER hard key.</p> |
| <p>2. Set the modulation test limit</p> <p>LIMIT</p> <p>[Modulation Test Limits]</p> <p>[Frequency Error]</p> <p>[Test Limits]</p> <p><On> or <Off></p> <p>[High Limit]</p> <p>[Low Limit]</p> <p>[EVM]</p> <p>[PDSCH EVM]</p> <p>[Test Limits]</p> <p><On> or <Off></p> <p>[High Limit (QPSK)]</p> <p>[High Limit (16QAM)]</p> <p>[High Limit (64QAM)]</p> <p>[RS EVM]</p> <p>[Test Limits]</p> <p><On> or <Off></p> <p>[High Limit]</p> <p>[P-SS EVM]</p> <p>[Test Limits]</p> <p><On> or <Off></p> <p>[High Limit]</p> | <p>Press the LIMIT hot key.</p> <p>Press the Modulation Test Limits soft key.</p> <p>Press the Frequency Error soft key.</p> <p>Press the Test Limits soft key. Toggle between On and Off.</p> <p>Use the numeric keys to input value.</p> <p>Use the numeric keys to input value.</p> <p>Press the EVM soft key.</p> <p>Press the PDSCH EVM soft key.</p> <p>Press the Test Limits soft key. Toggle between On and Off.</p> <p>Press the High Limit (QPSK) soft key to input value.</p> <p>Press the High Limit (16QAM) soft key to input value.</p> <p>Press the High Limit (64QAM) soft key to input value.</p> <p>Press the RS EVM soft key.</p> <p>Press the Test Limits soft key. Toggle between On and Off.</p> <p>Use the numeric keys and input.</p> <p>Press the P-SS EVM soft key.</p> <p>Press the Test Limits soft key. Toggle between On and Off.</p> <p>Use the numeric keys and input.</p> |

| | |
|---|--|
| <p>[S-SS EVM] [Test Limits] <On> or <Off> [High Limit]</p> <p>[Power] [DL RS Power] [Test Limit] <On> or <Off> [High Limit] [Low Limit]</p> <p>[P-SS Power] [Test Limits] <On> or <Off> [High Limit] [Low Limit]</p> <p>[S-SS Power] [Test Limits] <On> or <Off> [High Limit] [Low Limit]</p> <p>[Time Alignment Error] [Test Limits] <On> or <Off> [High Limit]</p> | <p>Press the S-SS EVM soft key. Press the Test Limits soft key. Toggle between On and Off. Use the numeric keys and input.</p> <p>Press the Power soft key. Press the DL RS Power soft key. Press the Test Limit soft key. Toggle between On and Off. Use the numeric keys and input. Use the numeric keys and input.</p> <p>Press the P-SS Power soft key. Press the Test Limit soft key. Toggle between On and Off. Use the numeric keys and input. Use the numeric keys and input.</p> <p>Press the S-SS Power soft key. Press the Test Limit soft key. Toggle between On and Off. Use the numeric keys and input. Use the numeric keys and input.</p> <p>Press the Time Alignment Error soft key. Press the Test Limits soft key. Toggle between On and Off. Use the numeric keys to input value.</p> |
| <p>3. Enable beep LIMIT [Beep] <On> or <Off></p> | <p>Press the LIMIT hot key. Press the Beep soft key to toggle between On and Off and select one. This will make audible alarm if the measurement result goes beyond the limit.</p> |

n **CHANNEL POWER:** Sets the test limit parameters.

Y **TEST LIMITS:** Enables or disables Pass/Fail results on the display screen. Toggle the **Test Limits** soft key to set it to **On** or **Off**.

Y **HIGH LIMIT:** Sets the upper limit of the Pass/Fail criteria. Use the numeric keys to enter a threshold or limit value and press the **dBm** unit soft key or the **ENTER** hard key to complete the input.

Y **LOW LIMIT:** Sets the lower limit of the Pass/Fail criteria. Use the numeric keys to enter a threshold or limit value and press the **dBm** unit soft key or the **ENTER** hard key to complete

the input.

- n **OCCUPIED BW:** *This key is not used in the Signal Performance mode.*
- n **SPECTRUM EMISSION MASK:** *This key is not used in the Signal Performance mode.*
- n **ACLR:** *This key is not used in the Signal Performance mode.*
- n **MULTI-ACLR:** *This key is not used in the Signal Performance mode.*
- n **SPURIOUS EMISSIONS:** *This key is not used in the Signal Performance mode.*
- n **FREQUENCY ERROR:** Sets the frequency error limit.
- Y **TEST LIMITS:** Enables or disables the test limits. Toggle this soft key between **On** and **Off**.
- Y **HIGH LIMIT:** Sets the upper limit. Use the numeric keys to input value and press the unit soft key or the **ENTER** hard key to complete the input.
- Y **LOW LIMIT:** Sets the lower limit. Use the numeric keys to input value and press the unit soft key or the **ENTER** hard key to complete the input.
- n **EVM:** Sets limits for Error Vector Magnitude.
 - Y **PDSCH EVM:** Sets the limit of the PDSCH EVM.
 - **TEST LIMITS:** Enables or disables the test limit. Toggle this soft key between **On** and **Off**.
 - **HIGH LIMIT (QPSK):** Sets the upper limit of QPSK. Use the numeric keys to input value and press the unit soft key or the **ENTER** hard key to complete the input.
 - **HIGH LIMIT (16QAM):** Sets the upper limit of 16QAM. Use the numeric keys to input value and press the unit soft key or the **ENTER** hard key to complete the input.
 - **HIGH LIMIT (64QAM):** Sets the upper limit of 64QAM. Use the numeric keys to input value and press the unit soft key or the **ENTER** hard key to complete the input.
 - Y **DATA EVM RMS:** *This key is not used in the Signal Performance mode.*
 - Y **DATA EVM PEAK:** *This key is not used in the Signal Performance mode.*
 - Y **RS EVM:** Sets the RS EVM.
 - **TEST LIMITS:** Enables or disables the test limits. Toggle this soft key between **On** and **Off**.
 - **HIGH LIMIT:** Sets the upper limit. Use the numeric keys to input value and press the unit soft key or the **ENTER** hard key to complete the input.
 - Y **P-SS EVM:** Sets the P-SS EVM.
 - **TEST LIMITS:** Enables or disables the test limits. Toggle this soft key between **On** and **Off**.

- **HIGH LIMIT:** Sets the upper limit. Use the numeric keys to input value and press the unit soft key or the **ENTER** hard key to complete the input.
- Y **S-SS EVM:** Sets the S-SS EVM.
- **TEST LIMITS:** Enables or disables the test limits. Toggle this soft key between **On** and **Off**.
 - **HIGH LIMIT:** Sets the upper limit. Use the numeric keys to input value and press the unit soft key or the **ENTER** hard key to complete the input.
- n **POWER:** Set power limits.
- Y **DL RS POWER:** Sets the Downlink RS power limit.
- **TEST LIMITS:** Enables or disables the test limits. Toggle this soft key between **On** and **Off**.
 - **HIGH LIMIT:** Sets the upper limit. Use the numeric keys to input value and press the unit soft key or the **ENTER** hard key to complete the input.
 - **LOW LIMIT:** Sets the lower limit. Use the numeric keys to input value and press the unit soft key or the **ENTER** hard key to complete the input.
- Y **P-SS POWER:** Sets the P-SS power limit.
- **TEST LIMITS:** Enables or disables the test limits. Toggle this soft key between **On** and **Off**.
 - **HIGH LIMIT:** Sets the upper limit. Use the numeric keys to input value and press the unit soft key or the **ENTER** hard key to complete the input.
 - **LOW LIMIT:** Sets the lower limit. Use the numeric keys to input value and press the unit soft key or the **ENTER** hard key to complete the input.
- Y **S-SS POWER:** Sets the S-SS power limit.
- **TEST LIMITS:** Enables or disables the test limits. Toggle this soft key between **On** and **Off**.
 - **HIGH LIMIT:** Sets the upper limit. Use the numeric keys to input value and press the unit soft key or the **ENTER** hard key to complete the input.
 - **LOW LIMIT:** Sets the lower limit. Use the numeric keys to input value and press the unit soft key or the **ENTER** hard key to complete the input.
- Y **PBCH POWER:** *This key is not used in the Signal Performance mode.*
- Y **SUBFRAME POWER:** *This key is not used in the Signal Performance mode.*
- Y **OFDM SYMBOL POWER:** *This key is not used in the Signal Performance mode.*
- Y **FRAME AVG POWER:** *This key is not used in the Signal Performance mode.*

- n **TIME ALIGNMENT ERROR:** Sets the limit of time alignment error.
- Y **TEST LIMIT:** Enables or disables the test limit. Toggle this soft key between **On** and **Off**.
- Y **HIGH LIMIT:** Sets the upper limit. Use the numeric keys to input value and press the unit soft key or the **ENTER** hard key to complete the input.
- n **TIME ERROR:** *This key is not used in the Signal Performance mode.*
- n **IQ ORIGIN OFFSET:** *This key is not used in the Signal Performance mode.*

Measurement Procedure

| Step | Description |
|---|---|
| 1. Select the mode MEASURE [Auto Measure] [Signal Performance] | Press the MEASURE hot key. Press the Auto Measure soft key. Press the Signal Performance soft key. |
| 2. Set the measurement parameters MEASURE SETUP [Cell ID] <Auto> or <Manual> Enter a value [Enter] [Antenna Port] <Auto>, <0>, or <1> [Bandwidth] [1.4 MHz], [3 MHz], [5 MHz], [10 MHz], [15 MHz], or [20 MHz] [RF Profile] <On> or <Off> [Modulation Profile] <On> or <Off> [MIMO Profile] <On> or <Off> | Press the MEASURE SETUP hot key. Press the Cell ID soft key. Toggle between Auto and Manual . Use the numeric keys to set the Cell ID manually. Press the Enter soft key. Press the Antenna Port soft key. Each time this soft key is pressed, selection changes among Auto , 0 , and 1 . Press the Bandwidth soft key. Press one of the soft keys to select. Press the RF Profile soft key. Toggle this key between On and Off . Press the Modulation Profile soft key. Toggle this key between On and Off . Press the MIMO Profile soft key. Toggle this key between On and Off . |

LTE - FDD Auto Measurement Signal Performance Test Procedure

MEASURE SETUP



- n **CELL ID:** Enables or disables automatic detection of the Cell ID of the transmitted LTE signal. Manually setting the Cell ID to a specific one can speed up to get synchronization with BTS.
- Y **AUTO:** Detects the Cell ID automatically.

- Y **MANUAL:** Sets the Cell ID to a specific one.
- n **ANTENNA PORT:** Sets the antenna port number automatically or manually. Each time this soft key is pressed, selection changes among **Auto**, **0**, and **1**.
- n **BANDWIDTH:** Selects the nominal channel bandwidth to be measured among **1.4 MHz**, **3 MHz**, **5 MHz**, **10 MHz**, **15 MHz**, and **20 MHz**.
- n **EXTERNAL OFFSET:** Sets an external offset value. An offset consists of a cable loss and a user offset and the measurement result shows the value reflecting both offset values. When the external offset value is set at 40 dB in the Spectrum mode, the measurement result compensates 40 dB at both the Spectrum Analyzer and Signal Analyzer modes.
- n **RF PROFILE:** Turns on or off the RF profiling such as Channel Power and Subframe Frequency Error.
- n **MODULATION PROFILE:** Turns on or off the modulation profiling such as P-SS, S-SS, Data - QPSK, Data - 16QAM, and Data - 64QAM.
- n **MIMO PROFILE:** Turns on or off the MIMO profiling such as TX1 - RS0, TX2 - RS1, and Time Alignment Error.

POWER STATISTICS CCDF

Power Statistics Complementary Cumulative Distribution Function (CCDF) measurement characterizes the power statistics of input signal. It provides PAR (Peak to Average power Ratio) versus different probabilities.

Setting Mode

| Step | Description |
|--|---|
| 1. Connect the cable | Connect a cable directly or indirectly as shown in the section Connecting a Cable on page 8 of this chapter. |
| 2. Set the measurement mode MEASURE [Signal Analyzer] [LTE - FDD] [Power Statistics CCDF] | Press the MEASURE hot key. Press the Signal Analyzer soft key. Press the LTE - FDD soft key. Press the Power Statistics CCDF soft key. |

Setting Frequency

| Step | Description |
|--|--|
| <p>1. Set the frequency</p> <p>FREQ/DIST</p> <p>[Unit]</p> <p><Freq> or <Channel></p> <p><i>When Freq is selected:</i></p> <p>[Center Frequency]</p> <p>Enter a value</p> <p>[GHz], [MHz], [kHz], or [Hz]</p> <p><i>When Channel is selected:</i></p> <p>[Channel Standard]</p> <p>Select a channel standard</p> <p>[Select] or ENTER</p> <p>[Channel Number]</p> <p>Enter a value</p> <p>[Forward]</p> | <p>Press the FREQ/DIST hard key.</p> <p>Press the Unit soft key. Toggle this key between Freq and Channel. A set of Freq/Dist screen menu changes accordingly.</p> <p>Press the Center Frequency soft key.</p> <p>Use the numeric keys, the rotary knob, or the arrow keys.</p> <p>When using the numeric keys, the input is completed by selecting one of the unit soft keys.</p> <p>Press the Channel Standard soft key. If this channel standard shows its default setting Band Global, go set the channel number directly.</p> <p>Press the arrow keys, rotate the knob, or press the Page Up and Page Down soft keys to highlight a frequency band to select.</p> <p>Press the Select soft key or the ENTER hard key.</p> <p>Press the Channel Number soft key.</p> <p>Use the numeric keys to input value and press the Forward soft key to complete the input. The instrument automatically displays its corresponding center frequency value for the channel number.</p> |

FREQ/DIST



- n **UNIT:** Determines the way how to set the frequency band either with standard band or custom frequency band. Toggling this key between **Freq** and **Channel** changes a set of Freq/Dist screen menu automatically. When the **Channel** is selected, the instrument sets the **Channel Standard** setting to **Band Global** as default so that the user can set the **Channel Number** directly without choosing a standard channel band from the list.
- n **CENTER FREQUENCY:** Changes the center frequency setting. Use the rotary knob or the arrow keys. Or use the numeric keys to input a certain value and press one of the unit soft keys to complete the input.
- n **FREQUENCY STEP:** Defines the amount of frequency to be increased or decreased when using the rotary knob or the arrow keys to change the **Center Frequency**. This frequency step size can be entered by using numeric keys and the unit soft keys.

- n **CHANNEL NUMBER:** Enters a channel number. The instrument automatically displays its corresponding center frequency value for the channel number.
- n **CHANNEL STEP:** Defines the amount of channel to be increased or decreased when using the rotary knob or the arrow keys to change the **Channel Number**. This channel step size can be entered by using numeric keys and the **Enter** soft key.
- n **CHANNEL STANDARD:** When the channel standard is selected from the list, the center frequency information on the display screen will be mapped accordingly to the selected channel standard. The channel standards available in the instrument are listed in the Appendix C – Band, Frequency & Channel Standard.

Setting Amplitude

| Step | Description |
|---|--|
| 1. Set the reference/attenuation level AMP/SCALE [Auto Scale] | Press the AMP/SCALE hard key. Press the Auto Scale soft key to automatically set optimum levels of reference and attenuation. |
| or | |
| [Attenuation] <Manual> | Press the Attenuation soft key. The Auto mode is set by default. This key toggles between the Auto and Manual . Press the Attenuation soft key to highlight the Manual mode and change the attenuation value to optimize S/N. |
| Enter an attenuation value | Use the numeric keys or the rotary knob that changes in a 5 dB step. The attenuation setting range is 0 to 50 dB. |

AMP/SCALE



- n **AUTO SCALE:** The instrument can automatically set the scale to the minimum and maximum values on the Y-axis of the graph for optimum display of the traces measured. Each time the **Auto Scale** is selected, the top and bottom scales are set to the minimum and maximum values with margin on the Y-axis of the display screen.
- n **ATTENUATION**
 - Y **AUTO:** Input attenuator's value is automatically set depending on the reference level. This is the default operation mode, so it is recommended to use this mode unless a special measurement condition is needed.
 - Y **MANUAL:** Sets the attenuator's value for the **Spectrum Analyzer RF In 50 Ω** port.

Setting Sweep Mode



This hot key is used to set the sweep parameters. The user input window must be inactive first to get the Sweep hot key function other than the number input.

- n **SWEEP MODE:** Sets the sweep method. Toggle between **Continue** and **Single**.

| Step | Description |
|--|---|
| 1. Set the sweep mode SWEEP [Sweep Mode] | Press the SWEEP hot key. Press the Sweep Mode soft key. Toggle between Continue and Single . |

Setting Trigger Source



This hot key is used to select the trigger source among **Internal**, **External**, and **GPS**. The user input window must be inactive first to get the Trigger hot key function other than the number input.

Setting External Clock

To enhance the reliability of modulation analysis measurements the JD740A series must be synchronized with the Base Station. When an external clock is not supplied, the JD740A series works with a built-in internal high-accuracy time base. In this case, some measurement results may exhibit inaccurate values. Therefore, it is highly recommended to use the same reference clock as signal source. Trigger mode can be changed by using the **TRIGGER** hot key.

EXTERNAL CLOCK OPERATING STANDARDS

| Clock | Type | Reference | Port | Switching Standard |
|--------------------|----------|--------------------|---------------|--|
| External Reference | Internal | Internal 10 MHz | | Default |
| | External | External Ref Clock | Ext Ref (SMA) | Manual switching (Input signal level >-3 dBm) |
| | GPS | GPS Clock | GPS (SMA) | Automatic switching (GPS signal received) |

| | | | | |
|---------|----------|------------------|---------------|------------------|
| Trigger | Internal | Internal Trigger | | Default |
| | External | External Trigger | Trigger (SMA) | Manual switching |
| | GPS | GPS | GPS (SMA) | Manual switching |

CONNECTION

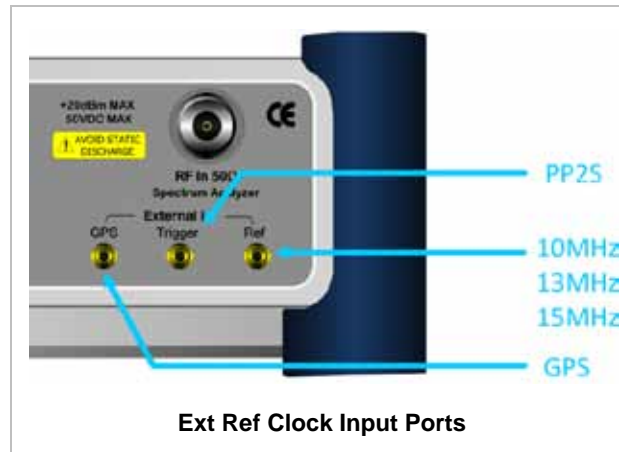







ENABLING EXTERNAL REFERENCE

| Step | Description |
|---|--|
| 1. Connect an external reference | Connect one of the external references or a GPS antenna to the JD740A series. |
| 2. Change reference clock SYSTEM [Frequency Reference] [External 10 MHz], [External 13 MHz], [External 15 MHz] or [GPS] | Press the SYSTEM hot key. Press the Frequency Reference soft key to select one of the external reference clocks or GPS. Press one of the soft keys to choose among External 10 MHz , External 13 MHz , External 15 MHz , and GPS . |

EXTERNAL REFERENCE INDICATOR INFORMATION

Each indicator tells different locking status according to a connection. When a GPS antenna is connected, longitude and latitude information will be displayed on the screen.

| Type | Indicator | Description |
|----------|---|-------------|
| Internal |  (Green) | Locked |
| External |  (Green) | Locked |

| | | |
|-----|--|----------------------------------|
| |  (Red) | Unlocked |
| GPS |  (Green) | Locked |
| |  (Yellow) | Locking in progress |
| |  (Gray) | Unable to lock or antenna failed |

Measurement Procedure

| Step | Description |
|--|---|
| 1. Set the measurement parameters MEASURE SETUP [CCDF Length] Enter a value [Enter] | Press the MEASURE SETUP hot key. Press the CCDF Length soft key. Use the numeric keys to input value. Press the Enter soft key. |

LTE - FDD Power Statistics CCDF Measurement Procedure

MEASURE SETUP



- n **CCDF LENGTH:** Sets the length of the CCDF which is the number of measurements to be averaged. To change the value, use the numeric keys and press the **Enter** soft key or the **ENTER** hard key to complete to the input (value range 1 to 100).

Measurement Example



LTE - FDD OTA MEASUREMENTS

The FDD LTE Over The Air (OTA) measurement has ID Scanner, Multipath Profile, Datagram, and Control Channel screens. The ID Scanner displays key parameters such as RSRP, RSRQ, RS-SINR and S-SS RSSI. The Multipath Profile enables the user to determine RF environmental conditions of testing area. The OTA Control Channel provides summary of all control channels including RS power variation over time.

FDD LTE OTA Measurements provide the following essential measurements.

- n ID Scanner
- n Multipath Profile
- n Control Channel
- n Datagram
- n Route Map

Setting Mode

Connecting a GPS antenna with the instrument is a mandatory for the OTA measurements.

| Step | Description |
|--|---|
| 1. Connect the antenna | Connect antennas as shown in the Connecting a Cable on page 9 of this chapter. |
| 2. Select the mode MODE [Signal Analyzer] [LTE - FDD] [OTA] [ID Scanner], [Multipath Profile], [Datagram], [Control Channel], or [Route Map] | Press the MODE hard key. Press the Signal Analyzer soft key. Press the LTE - FDD soft key. Press the OTA soft key. Press one of the measurement mode soft keys to select. |

Setting Frequency

| Step | Description |
|---|---|
| 1. Set the frequency FREQ/DIST [Unit] <Freq> or <Channel> <i>When Freq is selected:</i> [Center Frequency] Enter a value [GHz], [MHz], [kHz], or [Hz] <i>When Channel is selected:</i> [Channel Standard] Select a channel standard [Select] or ENTER [Channel Number] Enter a value | Press the FREQ/DIST hard key. Press the Unit soft key. Toggle this key between Freq and Channel . A set of Freq/Dist screen menu changes accordingly. Press the Center Frequency soft key. Use the numeric keys, the rotary knob, or the arrow keys. When using the numeric keys, the input is completed by selecting one of the unit soft keys. Press the Channel Standard soft key. If this channel standard shows its default setting Band Global, go set the channel number directly. Press the arrow keys, rotate the knob, or press the Page Up and Page Down soft keys to highlight a frequency band to select. Press the Select soft key or the ENTER hard key. Press the Channel Number soft key. Use the numeric keys to input value and press the Forward |

| | |
|------------------|--|
| [Forward] | soft key to complete the input. The instrument automatically displays its corresponding center frequency value for the channel number. |
|------------------|--|

FREQ/DIST



- n **UNIT:** Determines the way how to set the frequency band either with standard band or custom frequency band. Toggling this key between **Freq** and **Channel** changes a set of Freq/Dist screen menu automatically. When the **Channel** is selected, the instrument sets the **Channel Standard** setting to **Band Global** as default so that the user can set the **Channel Number** directly without choosing a standard channel band from the list.
- n **CENTER FREQUENCY:** Changes the center frequency setting. Use the rotary knob or the arrow keys. Or use the numeric keys to input a certain value and press one of the unit soft keys to complete the input.
- n **FREQUENCY STEP:** Defines the amount of frequency to be increased or decreased when using the rotary knob or the arrow keys to change the **Center Frequency**. This frequency step size can be entered by using numeric keys and the unit soft keys.
- n **CHANNEL NUMBER:** Enters a channel number. The instrument automatically displays its corresponding center frequency value for the channel number.
- n **CHANNEL STEP:** Defines the amount of channel to be increased or decreased when using the rotary knob or the arrow keys to change the **Channel Number**. This channel step size can be entered by using numeric keys and the **Enter** soft key.
- n **CHANNEL STANDARD:** When the channel standard is selected from the list, the center frequency information on the display screen will be mapped accordingly to the selected channel standard. The channel standards available in the instrument are listed in the Appendix C – Band, Frequency & Channel Standard.

Setting Amplitude

| Step | Description |
|---|--|
| 1. Set the reference/attenuation level AMP/SCALE [Auto Scale] or [Reference Level] | Press the AMP/SCALE hard key. Press the Auto Scale soft key to automatically set optimum levels of reference and attenuation. Press the Reference Level soft key to set manually. |

| | |
|-------------------------------|---|
| Enter a reference level value | Use the numeric keys or the rotary knob that changes in a 10 dB step. |
| [dBm] or ENTER | Press the dBm soft key or the ENTER hard key. |
| [Attenuation] | Press the Attenuation soft key. The Auto mode is set by default. This key toggles between the Auto and Manual . |
| <Manual> | Press the Attenuation soft key to highlight the Manual mode and change the attenuation value to optimize S/N. |
| Enter an attenuation value | Use the numeric keys or the rotary knob that changes in a 5 dB step. The attenuation setting range is 0 to 50 dB. |

AMP/SCALE



- n **AUTO SCALE:** The instrument can automatically set the scale to the minimum and maximum values on the Y-axis of the graph for optimum display of the traces measured. Each time the **Auto Scale** is selected, the top and bottom scales are set to the minimum and maximum values with margin on the Y-axis of the display screen.
- n **REFERENCE LEVEL:** Sets the maximum Y-axis range. *This key is used in the OTA Control Channel mode and the Route Map mode.*
- n **ATTENUATION**
 - Y **AUTO:** Input attenuator's value is automatically set depending on the reference level. This is the default operation mode, so it is recommended to use this mode unless a special measurement condition is needed.
 - Y **MANUAL:** Sets the attenuator's value for the **Spectrum Analyzer RF In 50 Ω** port.
- n **PREAMP:** Turns on or off the internal pre-amplifier. Preamp results in a correction being applied to compensate for the gain of the preamp so that amplitude readings show the value at the input connector. This soft key toggles between the **On** and **Off**. When it is set to On, the allowable attenuation input range is from 0 dB to 10 dB in a multiple of 5. If the attenuation value is manually set greater than 10 dB, the instrument will automatically turn off the pre-amplifier to display low level signal properly on the screen.
- n **EXTERNAL OFFSET:** Sets an external offset value. An offset consists of a cable loss and a user offset and the measurement result shows the value reflecting both offset values. When the external offset value is set at 40 dB in the Spectrum mode, the measurement result compensates 40 dB at both the Spectrum Analyzer and Signal Analyzer modes.

Setting Sweep Mode

SWEEP

This hot key is used to set the sweep parameters. The user input window must be inactive first to get the Sweep hot key function other than the number input.

- n **SWEEP MODE:** Sets the sweep method. Toggle between **Continue** and **Single**.

| Step | Description |
|--|---|
| 1. Set the sweep mode SWEEP [Sweep Mode] | Press the SWEEP hot key. Press the Sweep Mode soft key. Toggle between Continue and Single . |

Setting Trigger Source

TRIGGER

This hot key is used to select the trigger source among **Internal**, **External**, and **GPS**. The user input window must be inactive first to get the Trigger hot key function other than the number input. For OTA measurement, a GPS antenna should be connected and the trigger source should be set to **GPS**.

Setting External Clock

To enhance the reliability of modulation analysis measurements the JD740A series must be synchronized with the Base Station. When an external clock is not supplied, the JD740A series works with a built-in internal high-accuracy time base. In this case, some measurement results may exhibit inaccurate values. Therefore, it is highly recommended to use the same reference clock as signal source. Trigger mode can be changed by using the **TRIGGER** hot key.

EXTERNAL CLOCK OPERATING STANDARDS

| Clock | Type | Reference | Port | Switching Standard |
|--------------------|----------|--------------------|---------------|--|
| External Reference | Internal | Internal 10 MHz | | Default |
| | External | External Ref Clock | Ext Ref (SMA) | Manual switching (Input signal level >-3 dBm) |
| | GPS | GPS Clock | GPS (SMA) | Automatic switching (GPS signal received) |
| Trigger | Internal | Internal Trigger | | Default |

| | | | | |
|--|----------|------------------|---------------|------------------|
| | External | External Trigger | Trigger (SMA) | Manual switching |
| | GPS | GPS | GPS (SMA) | Manual switching |

CONNECTION

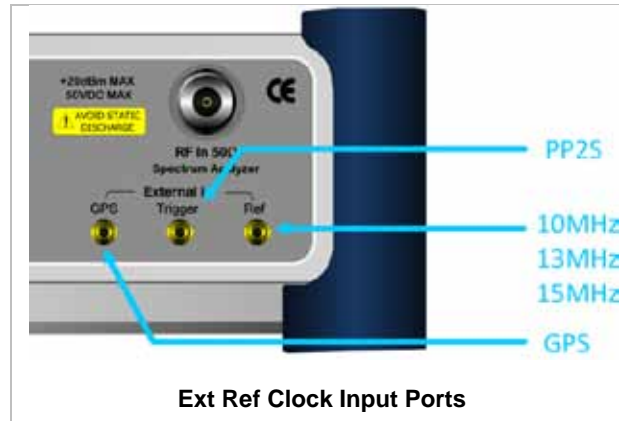

ENABLING GPS EXTERNAL REFERENCE

| Step | Description |
|--|--|
| 1. Connect a GPS antenna | Connect a GPS antenna to the JD740A series. |
| 2. Change reference clock SYSTEM [Frequency Reference] [GPS] | Press the SYSTEM hot key. Press the Frequency Reference soft key. Press the GPS soft key to perform OTA measurements. |

GPS EXTERNAL REFERENCE INDICATOR INFORMATION

When a GPS antenna is connected, the instrument automatically detects it. Each indicator tells different locking status depending on its connection. If it is successfully locked, the instrument will display "GPS" and longitude and latitude information on the screen. If it is unlocked or the antenna is disconnected, the display will be automatically switched to "Internal".

| Type | Indicator | Description |
|------|-----------|----------------------------------|
| GPS | (Green) | Locked |
| | (Yellow) | Locking in progress |
| | (Gray) | Unable to lock or antenna failed |

LTE - FDD OTA ID SCANNER

The LTE mobile receives signals from multiple base stations that all of these signals share the same spectrum and are present at the same time. Each base station has unique scrambling code assigned to the particular base station and it differentiates its signal from other base stations in the area.

The OTA ID Scanner shows key parameters such as RSRP (Reference Signal Received Power) and RSRQ (Reference Signal Received Quality) that predict quickly the downlink coverage.

- n RSRPs from entire cells help to rank between the different cells as input for handover and cell reselection decisions.
- n RSRQ provides additional information when RSPR is not sufficient to make a reliable handover or cell reselection decision.

All of the parameters for OTA ID scanner can be potted on a Google map and earth by using JDViewer.

Measurement Procedure

| Step | Description |
|--|--|
| 1. Set the measurement mode MEASURE [OTA] [ID Scanner] | Press the MEASURE hot key. Press the OTA soft key. Press the ID Scanner soft key. |
| 2. Set the measurement parameters MEASURE SETUP [Bandwidth] [1.4 MHz], [3 MHz], [5 MHz], [10 MHz], [15 MHz], or [20 MHz] [Auto Save] <On> or <Off> | Press the MEASURE SETUP hot key. Press the Bandwidth soft key. Press one of the soft keys to select. Press the Auto Save soft key. Toggle between On and Off . |

LTE - FDD OTA ID Scanner Measurement Procedure

MEASURE SETUP



- n **AUTO SAVE:** Enables or disables automatic saving of the measurement data to an external USB memory. When it turns on, the measurements will be recorded into the default file (logging.ota) or a user-named file.
- n **BANDWIDTH:** Selects the nominal channel bandwidth to be measured among **1.4 MHz, 3 MHz, 5 MHz, 10 MHz, 15 MHz, and 20 MHz**.
- n **MISCELLANEOUS**
 - Y **CYCLIC PREFIX:** Sets the cyclic prefix to **Normal** or **Extended**. For OFDM parameter details

by different bandwidth, refer to the table in the Appendix E – Cyclic Prefix Table.

Measurement Example



LTE - FDD OTA ID Scanner Measurement Screen

LTE - FDD OTA MULTIPATH PROFILE

The Multipath Profile enables the user to determine RF environmental conditions of testing area. It indicates the amount of power of the dominant pilot signal that is dispersed outside the main correlation peak due to multipath echoes that are expressed in dB. This value should be very small ideally.

The multipath profile is the result of portions of the original broadcast signal arriving at the receiving antenna out of phase. This can be caused by the signal being reflected off objects such as buildings, or being refracted through the atmosphere differently from the main signal.

Measurement Procedure

| Step | Description |
|---|--|
| 1. Set the measurement mode MEASURE [OTA] [Multipath Profile] | Press the MEASURE hot key. Press the OTA soft key. Press the Multipath Profile soft key. |
| 2. Set the measurement parameters MEASURE SETUP [Bandwidth] [1.4 MHz], [3 MHz], [5 MHz], [10 MHz], [15 MHz], or [20 MHz] [Display] <RS> or <Sync> [RS Window] [2 us], [4 us], or [8 us] | Press the MEASURE SETUP hot key. Press the Bandwidth soft key. Press one of the soft keys to select. Press the Display soft key to select its display mode. Toggle this key between RS and Sync . Press the RS Window soft key if the RS is set. Press one of the RS Window soft keys to choose. |

LTE - FDD OTA Multipath Profile Measurement Procedure

MEASURE SETUP



- n **BANDWIDTH:** Selects the nominal channel bandwidth to be measured among **1.4 MHz, 3 MHz, 5 MHz, 10 MHz, 15 MHz, and 20 MHz**.
- n **DISPLAY:** Sets the display mode to **RS** or **Sync**.
- n **RS WINDOW:** Selects the RS Window options among **2 us, 4 us, and 8 us**. This soft key is activated to be set only when the RS is selected for the display mode.
- n **MISCELLANEOUS**
 - Y **CYCLIC PREFIX:** Sets the cyclic prefix to **Normal** or **Extended**. For OFDM parameter details by different bandwidth, refer to the table in the Appendix E – Cyclic Prefix Table.

Measurement Example

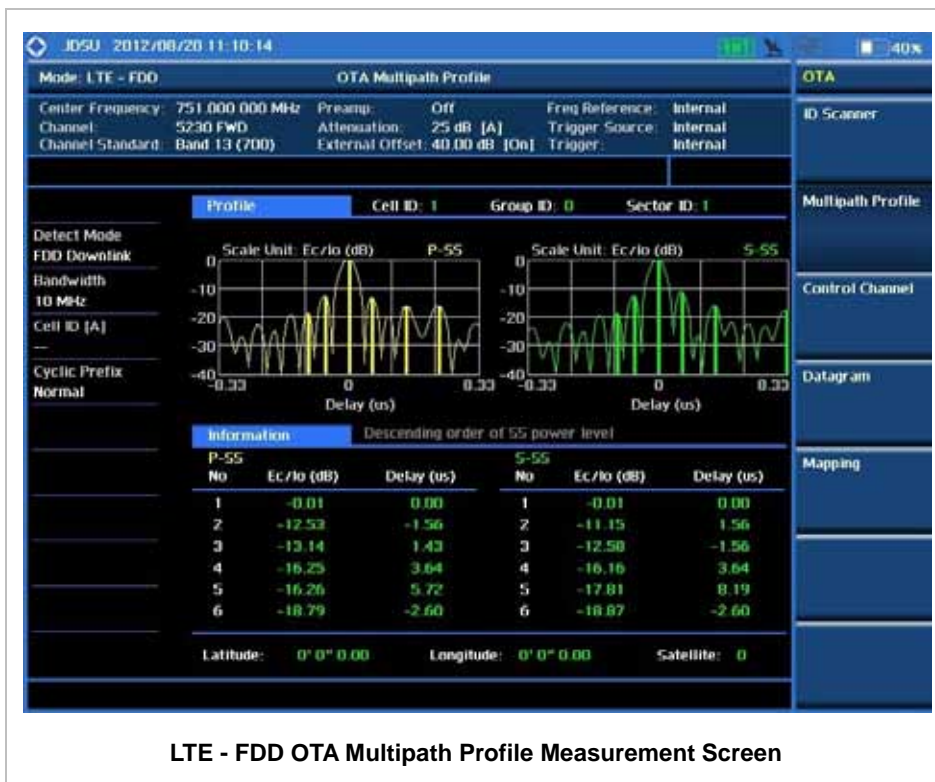

LTE - FDD OTA Multipath Profile Measurement Screen

LTE - FDD OTA CONTROL CHANNEL

DL RS power is the resource element power of Downlink Reference Symbol. The absolute DL RS power is indicated on the BCH. The absolute accuracy is defined as the maximum deviation between the DL RS power indicated on the BCH and the DL RS power at the BS antenna connector.

OTA Control Channel provides summary of all control channels including RS power trend over time. Positioning information, latitude and longitude will be displayed if a GPS antenna is supplied and locked to the GPS satellites on the bottom of the screen.

Measurement Procedure

| Step | Description |
|---|---|
| 1. Set the measurement mode MEASURE [OTA] [Control Channel] | Press the MEASURE hot key. Press the OTA soft key. Press the Control Channel soft key. |
| 2. Set the measurement parameters | |

| | |
|---|---|
| <p>MEASURE SETUP</p> <p>[Bandwidth] [1.4 MHz], [3 MHz], [5 MHz], [10 MHz], [15 MHz], or [20 MHz]</p> <p>[Cell ID] <Auto> or <Manual> Enter a value [Enter]</p> <p>[Subframe No] Enter a value [Enter]</p> <p>[Auto Save] <On> or <Off></p> | <p>Press the MEASURE SETUP hot key.</p> <p>Press the Bandwidth soft key.</p> <p>Press one of the soft keys to select.</p> <p>Press the Cell ID soft key. Toggle between Auto and Manual.</p> <p>Use the numeric keys to set the Cell ID manually.</p> <p>Press the Enter soft key.</p> <p>Press the Subframe No soft key.</p> <p>Use the numeric keys to input value.</p> <p>Press the Enter soft key to complete the input.</p> <p>Press the Auto Save soft key. Toggle between On and Off.</p> |
|---|---|

LTE - FDD OTA Control Channel Measurement Procedure

MEASURE SETUP



- n **AUTO SAVE:** Enables or disables automatic saving of the measurement data to an external USB memory. When it turns on, the measurements will be recorded into the default file (logging.ota) or a user-named file.
- n **BANDWIDTH:** Selects the nominal channel bandwidth to be measured among **1.4 MHz**, **3 MHz**, **5 MHz**, **10 MHz**, **15 MHz**, and **20 MHz**.
- n **CELL ID:** Enables or disables automatic detection of the Cell ID of the transmitted LTE signal. Manually setting the Cell ID to a specific one can speed up to get synchronization with BTS.
 - Y **AUTO:** Detects the Cell ID automatically.
 - Y **MANUAL:** Sets the Cell ID to a specific one.
- n **SUBFRAME NO:** Sets the subframe number to be measured.
- n **MISCELLANEOUS**
 - Y **ANTENNA PORT:** Sets the antenna port number automatically or manually. Each time this soft key is pressed, selection changes among **Auto**, **0**, and **1**.
 - Y **CYCLIC PREFIX:** Sets the cyclic prefix to **Normal** or **Extended**. For OFDM parameter details by different bandwidth, refer to the table in the Appendix E – Cyclic Prefix Table.

Measurement Example

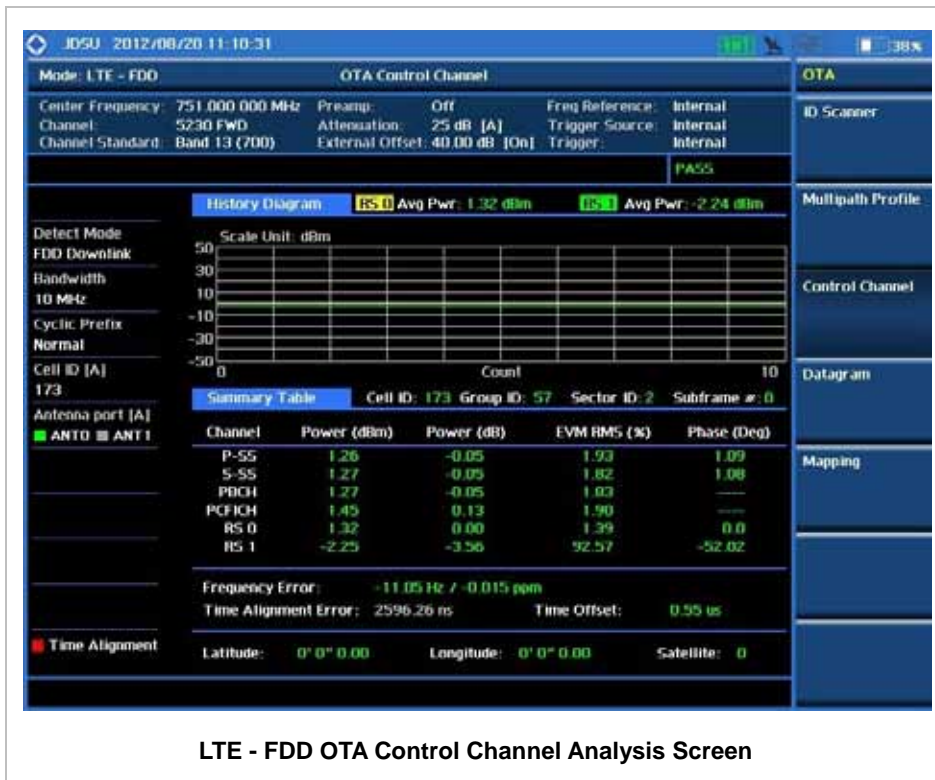

LTE - FDD OTA DATAGRAM

The OTA Datagram is a time-varying spectral representation that shows how the power of a signal varies with time. The power allocated to the specific resource block will be represented with an amplitude axis (in dBm) and the waterfall diagram will show the trend of past resource block power over certain period of time. Using a marker function facilitates analysis of accumulated resource block power for data utilization.

Measurement Procedure

| Step | Description |
|--|--|
| 1. Set the measurement mode MEASURE [OTA] [Datagram] | Press the MEASURE hot key. Press the OTA soft key. Press the Datagram soft key. |
| 2. Set the measurement parameters MEASURE SETUP [Bandwidth] [1.4 MHz], [3 MHz], [5 MHz], | Press the MEASURE SETUP hot key. Press the Bandwidth soft key. Press one of the soft keys to select. |

| | |
|---|--|
| <p>[10 MHz], [15 MHz], or [20 MHz]</p> <p>[Subframe No] Enter a value [Enter]</p> <p>[PDSCH Threshold] Enter a value [dB] or ENTER</p> <p>[Cell ID] <Auto> or <Manual> Enter a value [Enter]</p> <p>[Auto Save] <On> or <Off></p> | <p>Press the Subframe No soft key. Use the numeric keys to input value. Press the Enter soft key to complete the input.</p> <p>Press the PDSCH Threshold soft key. Use the numeric keys to input value. Press the unit soft key or the ENTER hard key to complete the input.</p> <p>Press the Cell ID soft key. Toggle between Auto and Manual. Use the numeric keys to set the Cell ID manually. Press the Enter soft key.</p> <p>Press the Auto Save soft key. Toggle between On and Off.</p> |
| <p>3. Analyze the measurement result</p> <p>[Time Cursor] <On> or <Off></p> | <p>Press the Time Cursor soft key. Toggle between On and Off.</p> |

LTE - FDD OTA Datagram Measurement Procedure

MEASURE SETUP



- n **RESET/RESTART:** Restarts the measurement.
- n **AUTO SAVE:** Enables or disables automatic saving of the measurement data to an external USB memory. When it turns on, the measurements will be recorded into the default file (logging.ota) or a user-named file.
- n **TIME CURSOR:** Enables or disables the time cursor indicator. When the time cursor is enabled after specifying a number, measurement is put on hold and information of the specific number is updated on the measurement screen.
- n **BANDWIDTH:** Selects the nominal channel bandwidth to be measured among **1.4 MHz**, **3 MHz**, **5 MHz**, **10 MHz**, **15 MHz**, and **20 MHz**.
- n **SUBFRAME NO:** Sets the subframe number to be measured.
- n **PDSCH THRESHOLD:** Sets the PDSCH threshold.
- n **CELL ID:** Enables or disables automatic detection of the Cell ID of the transmitted LTE signal. Manually setting the Cell ID to a specific one can speed up to get synchronization with BTS.
- Y **AUTO:** Detects the Cell ID automatically.

☒ **MANUAL:** Sets the Cell ID to a specific one.

n **MISCELLANEOUS**

☒ **CYCLIC PREFIX:** Sets the cyclic prefix to **Normal** or **Extended**. For OFDM parameter details by different bandwidth, refer to the table in the Appendix E – Cyclic Prefix Table.

Measurement Example



LTE - FDD OTA Datagram Analysis Screen

LTE - FDD ROUTE MAP

The JD740A Series provides indoor and outdoor mapping function that allows a user to collect data of points in an indoor or outdoor environment and track the received signals and coverage of RF transmitters plotting real time directly on top of a loaded floor plan or a map.

Measurement Procedure

| Step | Description |
|------|--------------------------|
| 1. | Set the measurement mode |

| | |
|--|---|
| <p>MEASURE [OTA] [Route Map]</p> | <p>Press the MEASURE hot key. Press the OTA soft key. Press the Route Map soft key.</p> |
| <p>2. Set the measurement parameters MEASURE SETUP [Load Map] [Plot Point] [Position] or [GPS] [Plot Item] [RSRP], [RSRQ], [RS-SINR], [S-SS RSSI], [P-SS Power], [S-SS Power], or [S-SS Ec/Io] [Screen Mode] <Map> or <Full> [Bandwidth] [1.4 MHz], [3 MHz], [5 MHz], [10 MHz], [15 MHz], or [20 MHz] [Plot] <Start> or <Stop></p> | <p>Press the MEASURE SETUP hot key. After plugging in a USB drive, press the Load Map soft key to load a map file created in JDMAPCreator and copied into the USB drive. Press the Plot Point soft key to get option menu. Press the Position soft key without a GPS antenna or the GPS with one. Selecting GPS activates the Screen Mode soft key to be set. Press the Plot Item soft key. Select one of the plot item soft keys as needed. Press the Screen Mode soft key. Toggle this key between Map and Full. Press the Bandwidth soft key. Press one of the soft keys to select. Press the Plot soft key to start or stop plotting. Toggle this key between Start and Stop.</p> |

MEASURE SETUP



Sets the measurement parameters for the Route Map. The legend displayed in different colors at the bottom of the screen can be set with the **Limit** hot key.

- n **PLOT:** Starts or stops a measurement in order to plot received signals or collected data on top of a loaded map. Toggle this key between **Start** and **Stop**. The instrument does not automatically save collected data. After stopping the current route mapping, the user needs to save the result with the **Save** hot key for later use. If not, all the collected data for the route will be lost.
- n **PLOT POINT:** Selects a method of plotting points.
- Y **POSITION:** Measures data without GPS in an indoor environment. After starting to plot, press the **Enter** hard key or the center of the rotary knob as you move with the instrument. Each

time the user presses the key or the knob, the instrument plots a point on top of the loaded map. Use the arrow keys to change direction of route and the rotary knob to change distance. If the instrument has the screen with touch screen, directly touch the screen in order to collect data.

- Y **GPS:** Automatically collects data with GPS in an outdoor environment and plots points as the user moves in a vehicle.
- n **PLOT ITEM:** Selects a plot item among RSRP, RSRQ, RS-SINR, S-SS RSSI, P-SS Power, S-SS Power, or S-SS Ec/Io. The instrument collects the strongest Cell ID data to plot points.
- n **SCREEN MODE:** Selects either **Map** or **Full**, depending on how to show collected points on the screen. Selecting GPS for the Plot Point activates this key. Numbers shown next to the points represent their Cell IDs. The instrument displays Cell ID of the start point and those of the points with different Cell IDs from the right previous ones.
- Y **MAP:** Displays collected points only that can be seen within the boundary of the loaded map. If a point is off the map, the instrument displays an arrow indicating the direction of the current location on the map and the distance from the center to the location at the top of the screen.
- Y **FULL:** Displays all the points measured for route on the screen without the map.
- n **LOAD MAP:** Loads a floor plan or a map file created in **JDMapCreator**. The JDMapCreator converts and resizes any scanned floor plan or layout so that it can be loaded and fit to the instrument display.
- n **BANDWIDTH:** Selects the nominal channel bandwidth to be measured among **1.4 MHz, 3 MHz, 5 MHz, 10 MHz, 15 MHz, and 20 MHz.**

Setting Limit



This hot key is used to set threshold values for the legend displayed on the screen. The different colors of the legend indicate the quality of the measured data depending on their threshold setting. The user input window must be inactive first to get the Limit hot key function other than the number input.

| Step | Description |
|--|---|
| 1. Set the limit Limit [RSRP] [Excellent] Enter a value | Press the LIMIT hot key. Press the RSRP soft key to set its threshold. Press the Excellent soft key. Use the rotary knob or the numeric keys. |

| | |
|-------------------------------------|--|
| [Enter] | Press the Enter soft key. |
| [Very Good] Enter a value | Press the Very Good soft key. Use the rotary knob or the numeric keys. |
| [Enter] | Press the Enter soft key. |
| [Good] Enter a value | Press the Good soft key. Use the rotary knob or the numeric keys. |
| [Enter] | Press the Enter soft key. |
| [Fair] Enter a value | Press the Fair soft key. Use the rotary knob or the numeric keys. |
| [Enter] | Press the Enter soft key. |
| [Poor] Enter a value | Press the Poor soft key. Use the rotary knob or the numeric keys. |
| [Enter] | Press the Enter soft key. |
| [RSRQ] | Press the RSRQ soft key to set its threshold. |
| [Good] Enter a value | Press the Good soft key. Use the rotary knob or the numeric keys. |
| [Enter] | Press the Enter soft key. |
| [Fair] Enter a value | Press the Fair soft key. Use the rotary knob or the numeric keys. |
| [Enter] | Press the Enter soft key. |
| [Poor] Enter a value | Press the Poor soft key. Use the rotary knob or the numeric keys. |
| [Enter] | Press the Enter soft key. |
| [RS-SINR] | Press the RS-SINR soft key to set its threshold. |
| [Good] Enter a value | Press the Good soft key. Use the rotary knob or the numeric keys. |
| [Enter] | Press the Enter soft key. |
| [Fair] Enter a value | Press the Fair soft key. Use the rotary knob or the numeric keys. |
| [Enter] | Press the Enter soft key. |
| [Poor] Enter a value | Press the Poor soft key. Use the rotary knob or the numeric keys. |
| [Enter] | Press the Enter soft key. |
| [S-SS RSSI] | Press the S-SS RSSI soft key to set its threshold. |
| [Excellent] Enter a value | Press the Excellent soft key. Use the rotary knob or the numeric keys. |
| [Enter] | Press the Enter soft key. |
| [Very Good] Enter a value | Press the Very Good soft key. Use the rotary knob or the numeric keys. |
| [Enter] | Press the Enter soft key. |
| [Good] | Press the Good soft key. |

| | |
|---|--|
| <p>Enter a value [Enter] [Fair]</p> | <p>Use the rotary knob or the numeric keys. Press the Enter soft key. Press the Fair soft key.</p> |
| <p>Enter a value [Enter] [Poor]</p> | <p>Use the rotary knob or the numeric keys. Press the Enter soft key. Press the Poor soft key.</p> |
| <p>Enter a value [Enter]</p> | <p>Use the rotary knob or the numeric keys. Press the Enter soft key.</p> |
| <p>[P-SS Power] [Excellent]</p> | <p>Press the P-SS Power soft key to set its threshold. Press the Excellent soft key.</p> |
| <p>Enter a value [Enter]</p> | <p>Use the rotary knob or the numeric keys. Press the Enter soft key.</p> |
| <p>[Very Good]</p> | <p>Press the Very Good soft key.</p> |
| <p>Enter a value [Enter]</p> | <p>Use the rotary knob or the numeric keys. Press the Enter soft key.</p> |
| <p>[Good]</p> | <p>Press the Good soft key.</p> |
| <p>Enter a value [Enter]</p> | <p>Use the rotary knob or the numeric keys. Press the Enter soft key.</p> |
| <p>[Fair]</p> | <p>Press the Fair soft key.</p> |
| <p>Enter a value [Enter]</p> | <p>Use the rotary knob or the numeric keys. Press the Enter soft key.</p> |
| <p>[Poor]</p> | <p>Press the Poor soft key.</p> |
| <p>Enter a value [Enter]</p> | <p>Use the rotary knob or the numeric keys. Press the Enter soft key.</p> |
| <p>[S-SS Power] [Excellent]</p> | <p>Press the S-SS Power soft key to set its threshold. Press the Excellent soft key.</p> |
| <p>Enter a value [Enter]</p> | <p>Use the rotary knob or the numeric keys. Press the Enter soft key.</p> |
| <p>[Very Good]</p> | <p>Press the Very Good soft key.</p> |
| <p>Enter a value [Enter]</p> | <p>Use the rotary knob or the numeric keys. Press the Enter soft key.</p> |
| <p>[Good]</p> | <p>Press the Good soft key.</p> |
| <p>Enter a value [Enter]</p> | <p>Use the rotary knob or the numeric keys. Press the Enter soft key.</p> |
| <p>[Fair]</p> | <p>Press the Fair soft key.</p> |
| <p>Enter a value [Enter]</p> | <p>Use the rotary knob or the numeric keys. Press the Enter soft key.</p> |
| <p>[Poor]</p> | <p>Press the Poor soft key.</p> |
| <p>Enter a value [Enter]</p> | <p>Use the rotary knob or the numeric keys. Press the Enter soft key.</p> |
| <p>[S-SS Ec/Io]</p> | <p>Press the RS-SINR soft key to set its threshold.</p> |

| | |
|---|--|
| <p>[Good] Enter a value [Enter]</p> <p>[Fair] Enter a value [Enter]</p> <p>[Poor] Enter a value [Enter]</p> | <p>Press the Good soft key.</p> <p>Use the rotary knob or the numeric keys.</p> <p>Press the Enter soft key.</p> <p>Press the Fair soft key.</p> <p>Use the rotary knob or the numeric keys.</p> <p>Press the Enter soft key.</p> <p>Press the Poor soft key.</p> <p>Use the rotary knob or the numeric keys.</p> <p>Press the Enter soft key.</p> |
|---|--|

Measurement Example





Route Map Measurement Screen (Full View)



Route Map Measurement Screen (Indoor)

ANALYSIS

Using Marker

MARKER



Marker is used to get the information about a specific trace. Six markers can be set on the display and each marker can be used independently. The X and Y coordinates of the trace are displayed when the marker is placed on any position of the trace. The position displaying the marker's X and Y coordinates may be slightly different for each measurement mode and refer to the description of each measurement. There are three different marker types available: Normal, Delta, and Delta pair. Marker position can be set manually by entering numeric values (frequency) when one of the marker types is selected.

- n **SELECT MARKER:** Selects an active marker whose position can be changed with the rotary knob or the arrow keys. The assigned number of the active marker is displayed in the **Select Marker** menu box and the active marker number is also displayed right next to the active marker on the trace when the **Marker View** is set to **On**.
- n **MARKER VIEW:** Displays the selected marker on the screen or hides it. When the **Marker View** is turned off and then on again in the same measurement mode, markers appear at the previous positions. If a measurement mode is changed, markers are not restored to their previous positions.
- n **NORMAL:** This Normal marker type provides the reading of a marker position on the trace along with the marker number between 1 and 6.
- n **DELTA:** This Delta marker type is associated with a Normal marker. A Normal marker must be set before a Delta marker is set. When the Delta marker is set, the position set by the Delta marker becomes the reference position of the Normal marker and the marker's X and Y values displays the difference compared with the Delta marker.
- n **DELTA PAIR:** This Delta Pair marker type is associated with a Normal marker. A Normal marker must be set before a Delta Pair marker is set. When the Delta Pair marker is set, the position set by the Delta Pair marker becomes the reference position of the Normal marker and the marker's X and Y values displays the difference compared with the Delta Pair marker. The reference position will be varied in accordance with trace change.
- n **MARKER ALL OFF:** Turns all the markers the screen off. When the Marker View is selected for those markers, the instrument displays those markers back at the previous position. If a measurement mode is changed, current settings are not restored.
- n **MARKER \rightarrow :** Sets the X coordinate of the active marker as selected.
- Y **MARKER \rightarrow CENTER:** Sets the frequency of the active marker to the center frequency of spectrum analyzer.
- Y **MARKER \rightarrow START:** Sets the frequency of the active marker to the start frequency of spectrum analyzer.

- **MARKERà STOP:** Sets the frequency of the active marker to the stop frequency of spectrum analyzer.

Using Peak Search

PEAK SEARCH



Each time the Peak Search soft key is pressed, the active marker is positioned at the highest peak of the trace.

- n **PEAK SEARCH:** Moves the active marker to the highest peak of the trace.
- n **NEXT PEAK:** Moves the active marker to the second highest peak of the trace.
- n **NEXT PEAK RIGHT:** Moves the active marker to the highest peak to the right of its current position.
- n **NEXT PEAK LEFT:** Moves the active marker to the highest peak to the left of its current position.
- n **MIN SEARCH:** Moves the active marker to the lowest peak of the trace.
- n **ALWAYS PEAK:** When the **Always Peak** is set to On, the instrument moves the active marker automatically to the highest peak of the trace every time the trace is refreshed.

LTE - TDD Signal Analyzer

This TDD LTE Signal Analyzer function is optional that the JD740A series offers as the Option 029. It allows the user to analyze TDD LTE system performance. The user may alter the measurement parameters for specialized analysis. The TDD LTE OTA Analyzer which is the Option 049 can be added to the TDD LTE Signal Analyzer for Over The Air measurement.

In this Chapter

| | |
|--------------------------------------|----|
| Using LTE - TDD Signal Analyzer..... | 5 |
| Display Overview..... | 6 |
| Connecting a Cable..... | 8 |
| Direct Connection..... | 8 |
| Indirect Connection..... | 8 |
| Over The Air (OTA)..... | 9 |
| Spectrum Analysis Measurement..... | 10 |
| Setting Mode..... | 10 |
| Setting Frequency..... | 10 |
| Setting Amplitude..... | 11 |
| Setting Averaging..... | 13 |
| Setting Sweep Mode..... | 13 |
| Setting Trigger Source..... | 13 |
| Setting External Clock..... | 14 |
| Setting Trace and Display..... | 15 |
| Measurement Procedure..... | 16 |
| Measurement Example..... | 17 |
| RF Analysis Measurements..... | 17 |
| Setting Mode..... | 18 |
| Setting Frequency..... | 18 |
| Setting Amplitude..... | 19 |
| Setting Averaging..... | 21 |
| Setting Sweep Mode..... | 21 |
| Setting Trigger Source..... | 21 |
| Setting External Clock..... | 22 |
| Channel Power..... | 23 |
| Measurement Procedure..... | 24 |
| Setting Limit..... | 24 |
| Measurement Example..... | 25 |
| Occupied Bandwidth..... | 26 |
| Measurement Procedure..... | 26 |
| Setting Limit..... | 27 |
| Measurement Example..... | 28 |

| | |
|---|----|
| Spectrum Emission Mask (SEM)..... | 28 |
| Measurement Procedure | 29 |
| Setting Limit | 30 |
| Measurement Example | 30 |
| ACLR | 31 |
| Measurement Procedure | 31 |
| Setting Limit | 32 |
| Measurement Example | 33 |
| Multi-ACLR | 33 |
| Measurement Procedure | 33 |
| Setting Limit | 35 |
| Measurement Example | 35 |
| Spurious Emissions | 36 |
| Measurement Procedure | 36 |
| Setting Limit | 38 |
| Measurement Example | 39 |
| Power vs Time Analysis Measurements | 39 |
| Setting Mode | 40 |
| Setting Frequency | 40 |
| Setting Amplitude | 41 |
| Setting Sweep Mode | 42 |
| Setting Trigger Source | 43 |
| Setting External Clock..... | 43 |
| Power vs Time (Slot) | 45 |
| Measurement Procedure | 45 |
| Setting Limit | 46 |
| Measurement Example | 47 |
| Power vs Time (Frame) Measurement | 48 |
| Measurement Procedure | 48 |
| Measurement Example | 49 |
| Modulation Analysis Measurements | 50 |
| Setting Mode | 50 |
| Setting Frequency | 51 |
| Setting Amplitude | 52 |
| Setting Sweep Mode | 53 |
| Setting Trigger Source | 54 |
| Setting External Clock..... | 54 |
| Constellation | 56 |
| Measurement Procedure | 56 |
| Setting Limit | 57 |
| Measurement Example | 60 |
| Data Channel..... | 60 |
| Measurement Procedure | 61 |
| Setting Limit | 62 |
| Measurement Example | 64 |
| Using Marker..... | 65 |
| Control Channel..... | 65 |
| Measurement Procedure | 65 |
| Setting Limit | 67 |
| Measurement Example | 69 |
| Using Marker..... | 69 |
| Subframe | 70 |
| Measurement Procedure | 70 |

| | |
|--------------------------------------|-----|
| Setting Limit | 72 |
| Setting Display | 76 |
| Measurement Example | 76 |
| Using Marker..... | 78 |
| Time Alignment Error | 78 |
| Measurement Procedure | 78 |
| Setting Limit | 79 |
| Measurement Example | 81 |
| Data Allocation Map..... | 81 |
| Measurement Procedure | 81 |
| Measurement Example | 82 |
| Using Marker..... | 83 |
| Auto Measurements | 83 |
| Setting Mode | 84 |
| Setting Trigger Source | 84 |
| Setting External Clock..... | 84 |
| Conformance Test | 86 |
| Setting Limit | 86 |
| Measurement Procedure | 92 |
| Maintenance Test | 94 |
| Setting Frequency | 94 |
| Setting Limit | 96 |
| Measurement Procedure | 103 |
| Setting Display | 106 |
| Signal Performance Test | 106 |
| Setting Frequency | 106 |
| Setting Sweep Mode | 108 |
| Setting Limit | 108 |
| Measurement Procedure | 112 |
| Power Statistics CCDF | 113 |
| Setting Mode | 114 |
| Setting Frequency | 114 |
| Setting Amplitude | 115 |
| Setting Sweep Mode | 116 |
| Setting Trigger Source | 116 |
| Setting External Clock..... | 117 |
| Measurement Procedure | 118 |
| Measurement Example | 119 |
| LTE - TDD OTA Measurements | 119 |
| Setting Mode | 120 |
| Setting Frequency | 120 |
| Setting Amplitude | 121 |
| Setting Sweep Mode | 123 |
| Setting Trigger Source | 123 |
| Setting External Clock..... | 123 |
| LTE - TDD OTA ID Scanner..... | 124 |
| Measurement Procedure | 125 |
| Measurement Example | 126 |
| LTE - TDD OTA Multipath Profile..... | 126 |
| Measurement Procedure | 126 |
| Measurement Example | 127 |
| LTE - TDD OTA Control Channel..... | 128 |
| Measurement Procedure | 128 |

| | |
|------------------------------|-----|
| Measurement Example | 129 |
| LTE - TDD OTA Datagram | 130 |
| Measurement Procedure | 130 |
| Measurement Example | 132 |
| LTE - TDD Route Map | 132 |
| Measurement Procedure | 132 |
| Setting Limit | 134 |
| Measurement Example | 137 |
| Analysis | 138 |
| Using Marker | 138 |
| Using Peak Search | 139 |

(Rev. 6.0)

USING LTE - TDD SIGNAL ANALYZER

The LTE (Long Term Evolution) Signal Analyzer of the JD740A series performs power and spectrum measurements as well as modulation analysis to test the proper transmitter performance of TDD LTE systems. It performs conformance testing according to the following standards providing a simple Pass/Fail indication on each test.

- n 3GPP TS 36.104. Evolved Universal Terrestrial Radio Access (E-UTRA); Base Station (BS) Radio Transmission and Reception
- n 3GPP TS 36.141. Evolved Universal Terrestrial Radio Access (E-UTRA); Base Station (BS) Conformance Testing
- n 3GPP TS 36.211. Evolved Universal Terrestrial Radio Access (E-UTRA); Physical Channels and Modulation
- n 3GPP TS 36.212. Evolved Universal Terrestrial Radio Access (E-UTRA); Multiplexing and Channel Coding
- n 3GPP TS 36.213 V8.2.0. Evolved Universal Terrestrial Radio Access (E-UTRA); Physical Layer Procedures

The LTE – TDD Signal Analyzer of the JD740A series provides the following analysis tools for TDD LTE system. The user may alter the measurement parameters for specialized analysis.

- n Spectrum Analysis
- n RF Analysis
 - Y Channel Power
 - Y Occupied Bandwidth
 - Y Spectrum Emission Mask
 - Y Adjacent Channel Leakage power Ratio (ACLR)
 - Y Multi-ACLR
 - Y Spurious Emissions
- n Power vs Time Analysis
 - Y Power vs Time (Slot)
 - Y Power vs Time (Frame)
- n Modulation Analysis
 - Y Constellation

- Y Data Channel
- Y Control Channel
- Y Subframe
- Y Time Alignment Error
- Y Data Allocation Map
- n Auto Measure
 - Y Conformance Test
 - Y Maintenance Test
 - Y Signal Performance Test
- n Power Statistics CCDF
- n Over The Air (OTA)
 - Y ID Scanner
 - Y Multipath Profile
 - Y Control Channel
 - Y Datagram
 - Y Route Map

DISPLAY OVERVIEW

Measurement Mode Information: LTE - TDD Signal Analyzer

Spectrum Input Level Setting Information: This window shows the most common settings or parameters of each measurement.

- Frequency and Channel Setting
- Amplitude Setting (Preamp, Attenuation, External Offset)
- Reference Setting (Frequency, Trigger)

Measurement Setting Information

- Spectrum Analyzer Operation Mode
- Detector Type Setting
- Spectrum Setting (RBW, VBW)
[A]: Auto mode, [M]: Manual mode
- Average Number Setting (the number of traces to be averaged)
- Bandwidth Setting

locked. When a GPS antenna is connected, this space will be blank.

- GPS Indicator: Color of the GPS icon changes among green, yellow and gray depending on locking status.
- USB Indicator
- DC Input Power Indicator
- Battery Indicator

Pass/Fail Indicator

CONNECTING A CABLE

Direct Connection

Connect the **Spectrum Analyzer RF In 50 Ω** port of the JD740A series and the PA output port of BTS.

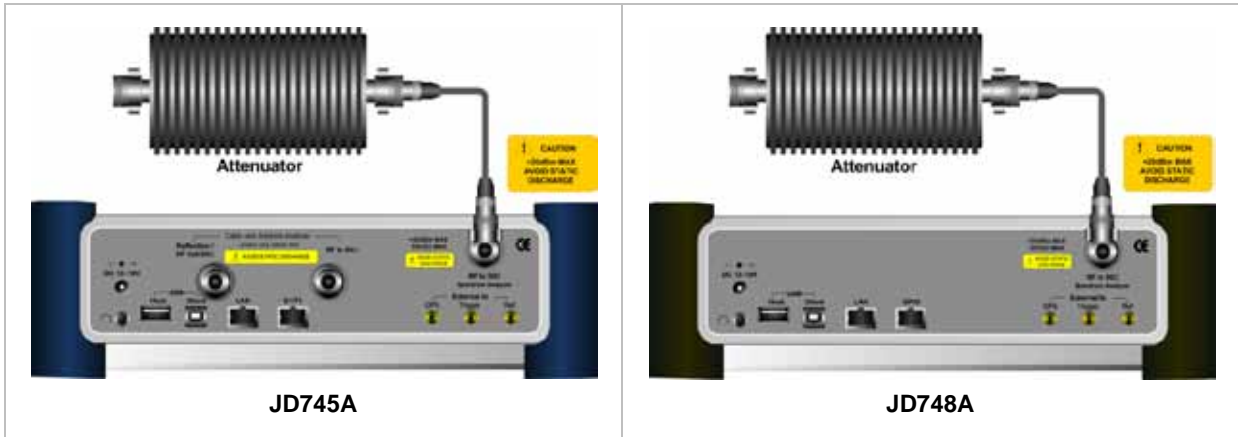

Indirect Connection

Connect the **Spectrum Analyzer RF In 50 Ω** port of the JD740A series and the monitor port of BTS.

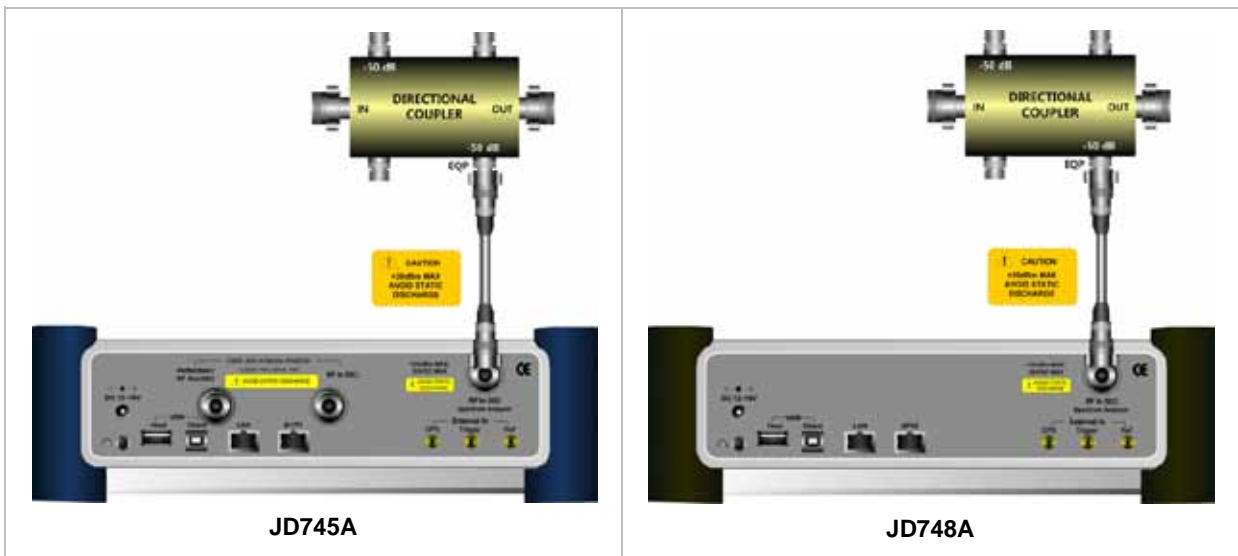





The maximum power for the **Spectrum Analyzer RF In 50 Ω** port is +20 dBm (0.1 Watt). If the input signal level to be measured is greater than +20 dBm, use a **High Power Attenuator** to prevent damage when you directly connect the signal to the instrument. Or connect a signal from the coupling port of a directional coupler.

Over The Air (OTA)

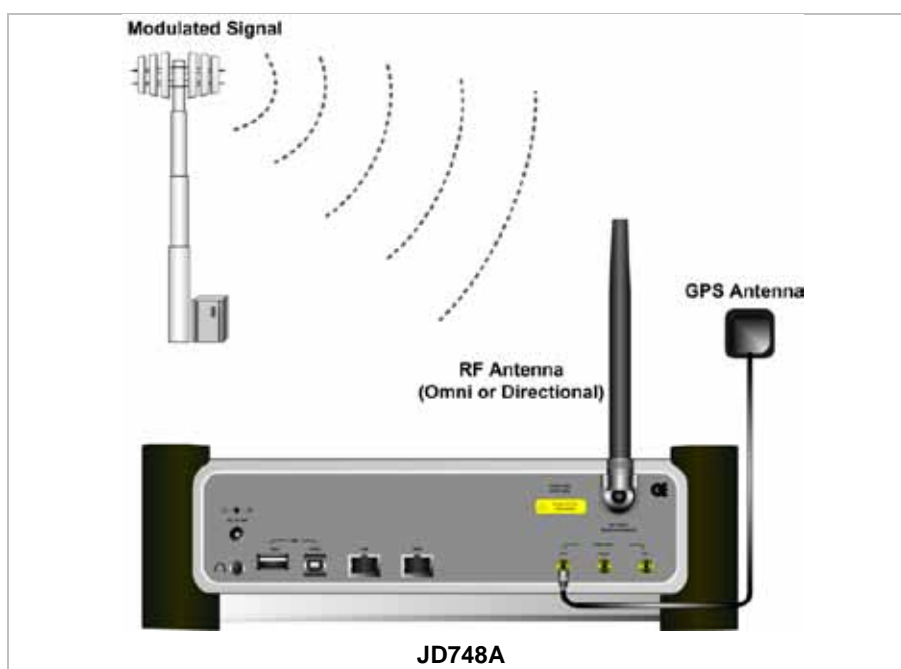
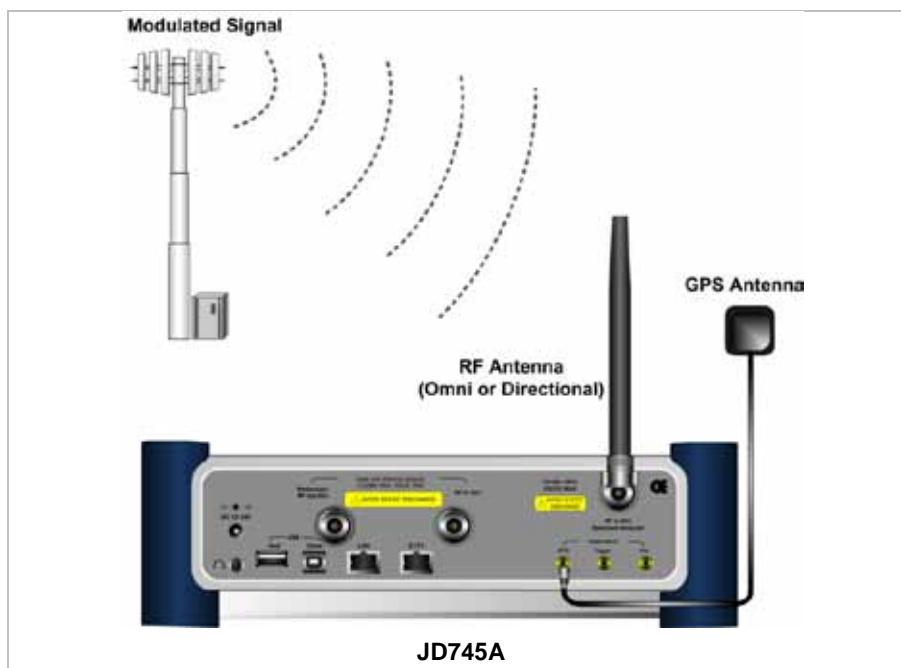
Connect an Omni/directional RF antenna to the **Spectrum Analyzer RF In 50 Ω** port of the JD740A series and then a GPS antenna to the **GPS** port of the JD740A series.



| | |
|---|--|
|  | <p>If the input signal level to be measured is less than 0 dBm, set 0 dB attenuation or turn on the preamp to have better dynamic range for the OTA testing.</p> |
|---|--|

SPECTRUM ANALYSIS MEASUREMENT

Setting Mode

| Step | Description |
|---|---|
| 1. Connect the cable | Connect a cable directly or indirectly as shown in the section Connecting a Cable on page 8 of this chapter. |
| 2. Select the mode MODE [Signal Analyzer] [LTE - TDD] [Spectrum] | <p>Press the MODE hard key.</p> <p>Press the Signal Analyzer soft key.</p> <p>Press the LTE - TDD soft key to select TDD LTE mode.</p> <p>Press the Spectrum soft key. (Spectrum mode is set by default.)</p> |

Setting Frequency

| Step | Description |
|---|--|
| 1. Set the frequency FREQ/DIST [Unit] <Freq> or <Channel> | <p>Press the FREQ/DIST hard key.</p> <p>Press the Unit soft key. Toggle this key between Freq and Channel. A set of Freq/Dist screen menu changes accordingly.</p> |
| <p><i>When Freq is selected:</i></p> <p>[Center Frequency] Enter a value [GHz], [MHz], [kHz], or [Hz]</p> | <p>Press the Center Frequency soft key.</p> <p>Use the numeric keys, the rotary knob, or the arrow keys.</p> <p>When using the numeric keys, the input is completed by selecting one of the unit soft keys.</p> |
| <p><i>When Channel is selected:</i></p> <p>[Channel Standard] Select a channel standard</p> | <p>Press the Channel Standard soft key. If this channel standard shows its default setting Band Global, go set the channel number directly.</p> <p>Press the arrow keys, rotate the knob, or press the Page Up</p> |

| | |
|---|--|
| <p>[Select] or ENTER</p> | <p>and Page Down soft keys to highlight a frequency band to select. Press the Select soft key or the ENTER hard key.</p> |
| <p>[Channel Number] Enter a value [Forward]</p> | <p>Press the Channel Number soft key. Use the numeric keys to input value and press the Forward soft key to complete the input. The instrument automatically displays its corresponding center frequency value for the channel number.</p> |

FREQ/DIST



- n **UNIT:** Determines the way how to set the frequency band either with standard band or custom frequency band. Toggling this key between **Freq** and **Channel** changes a set of Freq/Dist screen menu automatically. When the **Channel** is selected, the instrument sets the **Channel Standard** setting to **Band Global** as default so that the user can set the **Channel Number** directly without choosing a standard channel band from the list.
- n **CENTER FREQUENCY:** Changes the center frequency setting. Use the rotary knob or the arrow keys. Or use the numeric keys to input a certain value and press one of the unit soft keys to complete the input.
- n **FREQUENCY STEP:** Defines the amount of frequency to be increased or decreased when using the rotary knob or the arrow keys to change the **Center Frequency**. This frequency step size can be entered by using numeric keys and the unit soft keys.
- n **CHANNEL NUMBER:** Enters a channel number. The instrument automatically displays its corresponding center frequency value for the channel number.
- n **CHANNEL STEP:** Defines the amount of channel to be increased or decreased when using the rotary knob or the arrow keys to change the **Channel Number**. This channel step size can be entered by using numeric keys and the **Enter** soft key.
- n **CHANNEL STANDARD:** When the channel standard is selected from the list, the center frequency information on the display screen will be mapped accordingly to the selected channel standard. The channel standards available in the instrument are listed in the Appendix C – Band, Frequency & Channel Standard.

Setting Amplitude

| Step | Description |
|--|---|
| <p>1. Set the reference/attenuation level AMP/SCALE</p> | <p>Press the AMP/SCALE hard key.</p> |

| | |
|---|---|
| <p>[Auto Scale]</p> <p>or</p> | <p>Press the Auto Scale soft key to automatically set optimum levels of reference and attenuation.</p> |
| <p>[Reference Level] Enter a reference level value</p> | <p>Press the Reference Level soft key to set manually. Use the numeric keys or the rotary knob that changes in a 10 dB step.</p> |
| <p>[dBm] or ENTER</p> | <p>Press the dBm soft key or the ENTER hard key.</p> |
| <p>[Attenuation] <Manual></p> | <p>Press the Attenuation soft key. The Auto mode is set by default. This key toggles between the Auto and Manual. Press the Attenuation soft key to highlight the Manual mode and change the attenuation value to optimize S/N.</p> |
| <p>Enter an attenuation value</p> | <p>Use the numeric keys or the rotary knob that changes in a 5 dB step. The attenuation setting range is 0 to 50 dB.</p> |

AMP/SCALE



- n **AUTO SCALE:** The instrument can automatically set the scale to the minimum and maximum values on the Y-axis of the graph for optimum display of the traces measured. Each time the **Auto Scale** is selected, the top and bottom scales are set to the minimum and maximum values with margin on the Y-axis of the display screen.
- n **REFERENCE LEVEL:** Sets the maximum Y-axis range.
- n **SCALE/DIV:** Is used only for the Spectrum measurement screen. It represents the value of one division on the horizontal scale. The default value is 10 dB per division and the Y-Scale is set to 100 dB. Selecting the **Scale/Div** soft key enables to set the value to 1 dB per division with the numeric keys or the rotary knob.
- n **ATTENUATION**
 - Y **AUTO:** Input attenuator's value is automatically set depending on the reference level. This is the default operation mode, so it is recommended to use this mode unless a special measurement condition is needed.
 - Y **MANUAL:** Sets the attenuator's value for the **Spectrum Analyzer RF In 50 Ω** port.
- n **PREAMP:** Turns on or off the internal pre-amplifier. Preamp results in a correction being applied to compensate for the gain of the preamp so that amplitude readings show the value at the input connector. This soft key toggles between the **On** and **Off**. When it is set to On, the allowable attenuation input range is from 0 dB to 10 dB in a multiple of 5. If the attenuation value is manually set greater than 10 dB, the instrument will automatically turn off the pre-amplifier to display low level signal properly on the screen.

- n **UNITS:** Sets the scale unit on the display among **dBm**, **dBV**, **dBmV**, **dBuV**, **V**, and **W**.
- n **EXTERNAL OFFSET:** Sets an external offset value. An offset consists of a cable loss and a user offset and the measurement result shows the value reflecting both offset values. When the external offset value is set at 40 dB in the Spectrum mode, the measurement result compensates 40 dB at both the Spectrum Analyzer and Signal Analyzer modes.

Setting Averaging



- n **AVERAGE:** Sets the number of measurements to be averaged for the trace presentation. A maximum of 100 times of averaging can be set.

| Step | Description |
|---|---|
| 1. Set the averaging BW/AVG [Average] | Press the BW/AVG hard key. Press the Average soft key. |
| 2. Enter number of averaging to set | Use the numeric keys and input a number between 1 and 100. When the averaging reaches to the number set here, a new measurement value replaces the earliest measurement value in sequence. |
| 3. [Enter] or ENTER | Press the Enter soft key or the ENTER hard key. |

Setting Sweep Mode



This hot key is used to set the sweep parameters. The user input window must be inactive first to get the Sweep hot key function other than the number input.

- n **SWEEP MODE:** Sets the sweep method. Toggle between **Continue** and **Single**.

| Step | Description |
|--|---|
| 1. Set the sweep mode SWEEP [Sweep Mode] | Press the SWEEP hot key. Press the Sweep Mode soft key. Toggle between Continue and Single . |

Setting Trigger Source

TRIGGER



This hot key is used to select the trigger source among **Internal**, **External**, and **GPS**. The user input window must be inactive first to get the Trigger hot key function other than the number input.

Setting External Clock

To enhance the reliability of modulation analysis measurements the JD740A series must be synchronized with the Base Station. When an external clock is not supplied, the JD740A series works with a built-in internal high-accuracy time base. In this case, some measurement results may exhibit inaccurate values. Therefore, it is highly recommended to use the same reference clock as signal source. Trigger mode can be changed by using the **TRIGGER** hot key.

EXTERNAL CLOCK OPERATING STANDARDS

| Clock | Type | Reference | Port | Switching Standard |
|--------------------|----------|--------------------|---------------|--|
| External Reference | Internal | Internal 10 MHz | | Default |
| | External | External Ref Clock | Ext Ref (SMA) | Manual switching (Input signal level >-3 dBm) |
| | GPS | GPS Clock | GPS (SMA) | Automatic switching (GPS signal received) |
| Trigger | Internal | Internal Trigger | | Default |
| | External | External Trigger | Trigger (SMA) | Manual switching |
| | GPS | GPS | GPS (SMA) | Manual switching |

CONNECTION

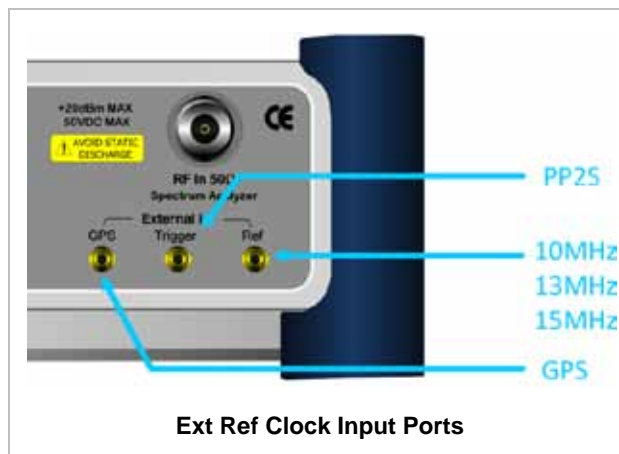

ENABLING EXTERNAL REFERENCE

| Step | Description |
|---|--|
| 1. Connect an external reference | Connect one of the external references or a GPS antenna to the JD740A series. |
| 2. Change reference clock SYSTEM [Frequency Reference] [External 10 MHz], [External 13 MHz], [External 15 MHz] or [GPS] | Press the SYSTEM hot key. Press the Frequency Reference soft key to select one of the external reference clocks or GPS. Press one of the soft keys to choose among External 10 MHz , External 13 MHz , External 15 MHz , and GPS . |

EXTERNAL REFERENCE INDICATOR INFORMATION

Each indicator tells different locking status according to a connection. When a GPS antenna is connected, longitude and latitude information will be displayed on the screen.

| Type | Indicator | Description |
|----------|--|----------------------------------|
| Internal |  (Green) | Locked |
| External |  (Green) | Locked |
| |  (Red) | Unlocked |
| GPS |  (Green) | Locked |
| |  (Yellow) | Locking in progress |
| |  (Gray) | Unable to lock or antenna failed |

Setting Trace and Display

TRACE/DISPLAY

- n **SELECT TRACE:** Selects an active trace from T1 to T6. Trace numbers are assigned to each captured trace or loaded trace. Pressing one of the 6 trace number soft keys sets the selected trace number as the active trace on the display screen.
- n **CLEAR WRITE:** Clears the selected trace and writes or assigns the current trace.
- n **MAX HOLD:** Sets the active trace to display the maximum response of the input signal. Active trace compares newly acquired data with the trace shown on the screen and displays the bigger trace on the display screen.

- n **MIN HOLD:** Sets the active trace to display the minimum response of the input signal. Active trace compares newly acquired data with the trace shown on the screen and displays the smaller trace on the display screen.
- n **CAPTURE:** Captures a current trace on the display screen with the selected trace number.
- n **TRACE VIEW:** Displays the trace of the selected trace number on the display screen or hides it from the display screen. Press the **Select Trace** soft key to select a trace number and then press the **Trace View** soft key to toggle between the **Off** to hide and **On** to restore a hidden trace.
- n **TRACE CLEAR ALL:** Deletes all traces from the instrument and initializes the trace settings.

Measurement Procedure

| Step | Description |
|---|--|
| 1. Select the mode MEASURE [Spectrum] | Press the MEASURE hot key. Press the Spectrum soft key. |
| 2. Set the measurement parameters MEASURE SETUP [Bandwidth] [1.4 MHz], [3 MHz], [5 MHz], [10 MHz], [15 MHz], or [20 MHz] [Subframe No] Enter a value [Enter] [Cell ID] <Auto> or <Manual> Enter a value [Enter] | Press the MEASURE SETUP hot key. Press the Bandwidth soft key. Press one of the soft keys to select. Press the Subframe No soft key. Use the numeric keys to input value. Press the Enter soft key to complete the input. Press the Cell ID soft key. Toggle between Auto and Manual . Use the numeric keys to set the Cell ID manually. Press the Enter soft key. |

LTE - TDD Spectrum Measurement Procedure

MEASURE SETUP



- n **BANDWIDTH:** Selects the nominal channel bandwidth to be measured among **1.4 MHz, 3 MHz, 5 MHz, 10 MHz, 15 MHz, and 20 MHz**.
- n **SUBFRAME NO:** Sets the subframe number to be measured.
- n **CELL ID:** Enables or disables automatic detection of the Cell ID of the transmitted LTE signal. Manually setting the Cell ID to a specific one can speed up to get synchronization with BTS.

- Y **AUTO:** Detects the Cell ID automatically.
- Y **MANUAL:** Sets the Cell ID to a specific one.

Measurement Example

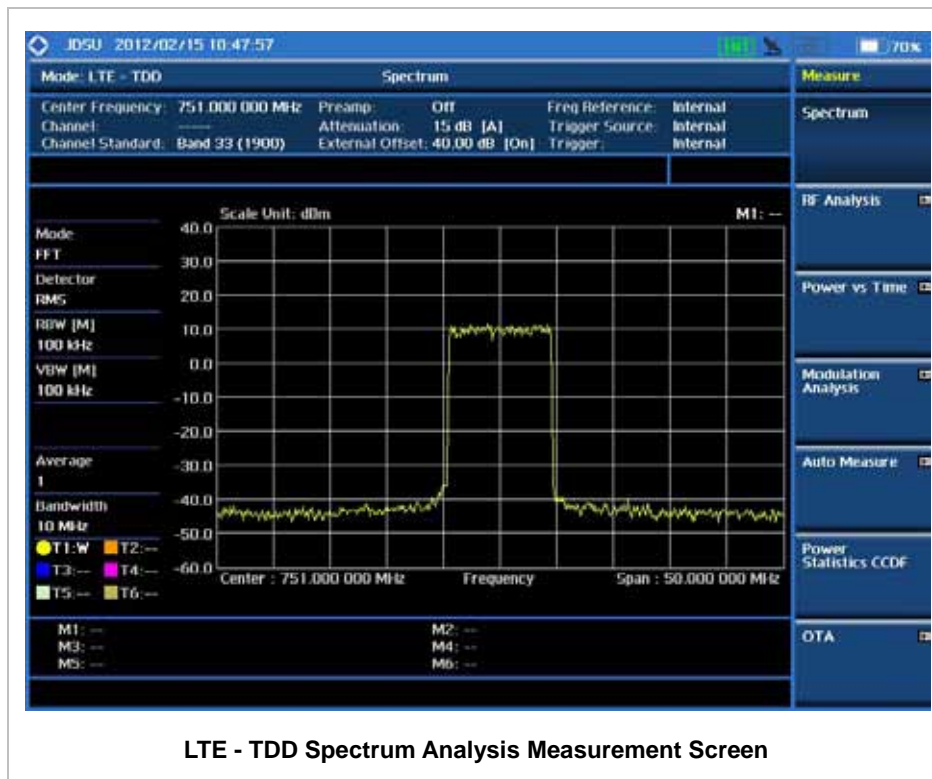

RF ANALYSIS MEASUREMENTS

RF Analysis in LTE - TDD Signal Analyzer provides single-button measurements for the following measurements.

- n Channel Power
- n Occupied Bandwidth
- n Spectrum Emission Mask
- n Adjacent Channel Leakage power Ratio (ACLR)
- n Multi-ACLR
- n Spurious Emissions

Setting Mode

| Step | Description |
|---|---|
| 1. Connect the cable | Connect a cable directly or indirectly as shown in the section Connecting a Cable on page 8 of this chapter. |
| 2. Select the mode MODE [Signal Analyzer] [LTE - TDD] [RF Analysis] [Channel Power], [Occupied BW], [Spectrum Emission Mask], [ACLR], [Multi-ACLR], or [Spurious Emissions] | Press the MODE hard key. Press the Signal Analyzer soft key. Press the LTE - TDD soft key. Press the RF Analysis soft key. Press one of the measurement mode soft keys to select. |

Setting Frequency

This setting is not used in the Multi-ACLR mode and the Spurious Emissions mode.

| Step | Description |
|---|--|
| 1. Set the frequency FREQ/DIST [Unit] <Freq> or <Channel> <i>When Freq is selected:</i> [Center Frequency] Enter a value [GHz], [MHz], [kHz], or [Hz] <i>When Channel is selected:</i> [Channel Standard] Select a channel standard | Press the FREQ/DIST hard key. Press the Unit soft key. Toggle this key between Freq and Channel . A set of Freq/Dist screen menu changes accordingly. Press the Center Frequency soft key. Use the numeric keys, the rotary knob, or the arrow keys. When using the numeric keys, the input is completed by selecting one of the unit soft keys. Press the Channel Standard soft key. If this channel standard shows its default setting Band Global, go set the channel number directly. Press the arrow keys, rotate the knob, or press the Page Up and Page Down soft keys to highlight a frequency band to select. |

| | |
|---|--|
| <p>[Select] or ENTER</p> | <p>Press the Select soft key or the ENTER hard key.</p> |
| <p>[Channel Number] Enter a value [Forward]</p> | <p>Press the Channel Number soft key. Use the numeric keys to input value and press the Forward soft key to complete the input. The instrument automatically displays its corresponding center frequency value for the channel number.</p> |

FREQ/DIST



- n **UNIT:** Determines the way how to set the frequency band either with standard band or custom frequency band. Toggling this key between **Freq** and **Channel** changes a set of Freq/Dist screen menu automatically. When the **Channel** is selected, the instrument sets the **Channel Standard** setting to **Band Global** as default so that the user can set the **Channel Number** directly without choosing a standard channel band from the list.
- n **CENTER FREQUENCY:** Changes the center frequency setting. Use the rotary knob or the arrow keys. Or use the numeric keys to input a certain value and press one of the unit soft keys to complete the input.
- n **FREQUENCY STEP:** Defines the amount of frequency to be increased or decreased when using the rotary knob or the arrow keys to change the **Center Frequency**. This frequency step size can be entered by using numeric keys and the unit soft keys.
- n **CHANNEL NUMBER:** Enters a channel number. The instrument automatically displays its corresponding center frequency value for the channel number.
- n **CHANNEL STEP:** Defines the amount of channel to be increased or decreased when using the rotary knob or the arrow keys to change the **Channel Number**. This channel step size can be entered by using numeric keys and the **Enter** soft key.
- n **CHANNEL STANDARD:** When the channel standard is selected from the list, the center frequency information on the display screen will be mapped accordingly to the selected channel standard. The channel standards available in the instrument are listed in the Appendix C – Band, Frequency & Channel Standard.

Setting Amplitude

| Step | Description |
|--|---|
| <p>1. Set the reference/attenuation level AMP/SCALE [Auto Scale]</p> | <p>Press the AMP/SCALE hard key. Press the Auto Scale soft key to automatically set optimum</p> |

| | |
|---|--|
| or | levels of reference and attenuation. |
| [Reference Level] Enter a reference level value | Press the Reference Level soft key to set manually. Use the numeric keys or the rotary knob that changes in a 10 dB step. |
| [dBm] or ENTER | Press the dBm soft key or the ENTER hard key. |
| [Attenuation] | Press the Attenuation soft key. The Auto mode is set by default. This key toggles between the Auto and Manual . |
| <Manual> Enter an attenuation value | Press the Attenuation soft key to highlight the Manual mode and change the attenuation value to optimize S/N. Use the numeric keys or the rotary knob that changes in a 5 dB step. The attenuation setting range is 0 to 50 dB. |

AMP/SCALE



- n **AUTO SCALE:** The instrument can automatically set the scale to the minimum and maximum values on the Y-axis of the graph for optimum display of the traces measured. Each time the **Auto Scale** is selected, the top and bottom scales are set to the minimum and maximum values with margin on the Y-axis of the display screen.
- n **REFERENCE LEVEL:** Sets the maximum Y-axis range.
- n **SCALE/DIV:** Is used only for the Spectrum measurement screen. It represents the value of one division on the horizontal scale. The default value is 10 dB per division and the Y-Scale is set to 100 dB. Selecting the **Scale/Div** soft key enables to set the value to 1 dB per division with the numeric keys or the rotary knob.
- n **ATTENUATION**
 - Y **AUTO:** Input attenuator's value is automatically set depending on the reference level. This is the default operation mode, so it is recommended to use this mode unless a special measurement condition is needed.
 - Y **MANUAL:** Sets the attenuator's value for the **Spectrum Analyzer RF In 50 Ω** port.
- n **PREAMP:** Turns on or off the internal pre-amplifier. Preamp results in a correction being applied to compensate for the gain of the preamp so that amplitude readings show the value at the input connector. This soft key toggles between the **On** and **Off**. When it is set to On, the allowable attenuation input range is from 0 dB to 10 dB in a multiple of 5. If the attenuation value is manually set greater than 10 dB, the instrument will automatically turn off the pre-amplifier to display low level signal properly on the screen.
- n **UNITS:** Sets the scale unit on the display among **dBm**, **dBV**, **dBmV**, **dBuV**, **V**, and **W**.

- n **EXTERNAL OFFSET:** Sets an external offset value. An offset consists of a cable loss and a user offset and the measurement result shows the value reflecting both offset values. When the external offset value is set at 40 dB in the Spectrum mode, the measurement result compensates 40 dB at both the Spectrum Analyzer and Signal Analyzer modes.

Setting Averaging

BW/AVG



- n **AVERAGE:** Sets the number of measurements to be averaged for the trace presentation. A maximum of 100 times of averaging can be set. *This setting is not used in the Spurious Emissions mode.*

| Step | Description |
|---|--|
| 1. Set the averaging BW/AVG [Average] | Press the BW/AVG hard key. Press the Average soft key. |
| 2. Enter number of averaging to set | Use the numeric keys and input a number between 1 and 100. When the averaging reaches to the number set here, a new measurement value replaces the earliest measurement value in sequence. |
| 3. [Enter] or ENTER | Press the Enter soft key or the ENTER hard key. |

Setting Sweep Mode

SWEEP



This hot key is used to set the sweep parameters. The user input window must be inactive first to get the Sweep hot key function other than the number input.

- n **SWEEP MODE:** Sets the sweep method. Toggle between **Continue** and **Single**.

| Step | Description |
|--|---|
| 1. Set the sweep mode SWEEP [Sweep Mode] | Press the SWEEP hot key. Press the Sweep Mode soft key. Toggle between Continue and Single . |

Setting Trigger Source

TRIGGER



This hot key is used to select the trigger source among **Internal**, **External**, and **GPS**. The user input window must be inactive first to get the Trigger hot key function other than the number input.

Setting External Clock

To enhance the reliability of modulation analysis measurements the JD740A series must be synchronized with the Base Station. When an external clock is not supplied, the JD740A series works with a built-in internal high-accuracy time base. In this case, some measurement results may exhibit inaccurate values. Therefore, it is highly recommended to use the same reference clock as signal source. Trigger mode can be changed by using the **TRIGGER** hot key.

EXTERNAL CLOCK OPERATING STANDARDS

| Clock | Type | Reference | Port | Switching Standard |
|--------------------|----------|--------------------|---------------|--|
| External Reference | Internal | Internal 10 MHz | | Default |
| | External | External Ref Clock | Ext Ref (SMA) | Manual switching (Input signal level >-3 dBm) |
| | GPS | GPS Clock | GPS (SMA) | Automatic switching (GPS signal received) |
| Trigger | Internal | Internal Trigger | | Default |
| | External | External Trigger | Trigger (SMA) | Manual switching |
| | GPS | GPS | GPS (SMA) | Manual switching |

CONNECTION

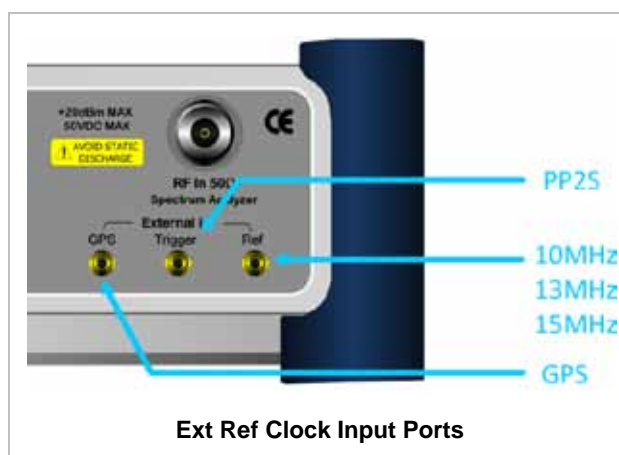

ENABLING EXTERNAL REFERENCE

| Step | Description |
|--|--|
| 1. Connect an external reference | Connect one of the external references or a GPS antenna to the JD740A series. |
| 2. Change reference clock SYSTEM [Frequency Reference] [External 10 MHz], [External 13 MHz], [External 15 MHz] or [GPS] | Press the SYSTEM hot key. Press the Frequency Reference soft key to select one of the external reference clocks or GPS. Press one of the soft keys to choose among External 10 MHz , External 13 MHz , External 15 MHz , and GPS . |

EXTERNAL REFERENCE INDICATOR INFORMATION

Each indicator tells different locking status according to a connection. When a GPS antenna is connected, longitude and latitude information will be displayed on the screen.

| Type | Indicator | Description |
|----------|--|----------------------------------|
| Internal |  (Green) | Locked |
| External |  (Green) | Locked |
| |  (Red) | Unlocked |
| GPS |  (Green) | Locked |
| |  (Yellow) | Locking in progress |
| |  (Gray) | Unable to lock or antenna failed |

CHANNEL POWER

The Channel Power measurement is a common test used in the wireless industry to measure the total transmitted power of a radio within a defined frequency channel. It acquires a number of points representing the input signal in the time domain, transforms this information into the frequency domain using Fast Fourier Transform (FFT) and then calculates the channel power. The effective resolution bandwidth of the frequency domain trace is proportional to the number of points acquired for the FFT.

The channel power measurement identifies the total RF power and power spectral density (PSD) of the signal in the LTE channel bandwidth.

Measurement Procedure

| Step | Description |
|---|--|
| 1. Set the measurement mode MEASURE [RF Analysis] [Channel Power] | Press the MEASURE hot key. Press the RF Analysis soft key. Press the Channel Power soft key. |
| 2. Set the measurement parameters MEASURE SETUP [Bandwidth] [1.4 MHz], [3 MHz], [5 MHz], [10 MHz], [15 MHz], or [20 MHz] [Subframe No] Enter a value [Enter] [Cell ID] <Auto> or <Manual> Enter a value [Enter] | Press the MEASURE SETUP hot key. Press the Bandwidth soft key. Press one of the soft keys to select. Press the Subframe No soft key. Use the numeric keys to input value. Press the Enter soft key to complete the input. Press the Cell ID soft key. Toggle between Auto and Manual . Use the numeric keys to set the Cell ID manually. Press the Enter soft key. |

LTE - TDD Channel Power Measurement Procedure

MEASURE SETUP



- n **BANDWIDTH:** Selects the nominal channel bandwidth to be measured among **1.4 MHz, 3 MHz, 5 MHz, 10 MHz, 15 MHz, and 20 MHz**.
- n **SUBFRAME NO:** Sets the subframe number to be measured.
- n **CELL ID:** Enables or disables automatic detection of the Cell ID of the transmitted LTE signal. Manually setting the Cell ID to a specific one can speed up to get synchronization with BTS.
 - Y **AUTO:** Detects the Cell ID automatically.
 - Y **MANUAL:** Sets the Cell ID to a specific one.

Setting Limit

LIMIT



This hot key is used to set the threshold value for the limit line on the display screen. It turns on or off the limit or band limit settings of the measurement for pass/fail indication. The user input window must

be inactive first to get the Limit hot key function other than the number input.

| Step | Description |
|---|---|
| 1. Select the limit LIMIT [RF Test Limits] [Channel Power] [Test Limits] <On> or <Off> [High Limit] Enter a value [dBm] or ENTER [Low Limit] Enter a value [dBm] or ENTER | Press the LIMIT hot key. Press the RF Test Limits soft key. Press the Channel Power soft key. Press the Test Limits soft key to toggle between On and Off and select one. Press the High Limit soft key to set the upper limit of the Pass/Fail criteria. Use the numeric keys to input value. Press the unit soft key or the ENTER hard key. Press the Low Limit soft key to set the lower limit of the Pass/Fail criteria. Use the numeric keys to input value. Press the unit soft key or the ENTER hard key. |
| 2. Enable beep LIMIT [Beep] <On> or <Off> | Press the LIMIT hot key. Press the Beep soft key to toggle between On and Off and select one. This will make audible alarm if the measurement result goes beyond the limit. |

- n **TEST LIMITS:** Enables or disables Pass/Fail results on the display screen. Toggle the **Test Limits** soft key to set it to **On** or **Off**.
- n **HIGH LIMIT:** Sets the upper limit of the Pass/Fail criteria. Use the numeric keys to enter a threshold or limit value and press the **dBm** unit soft key or the **ENTER** hard key to complete the input.
- n **LOW LIMIT:** Sets the lower limit of the Pass/Fail criteria. Use the numeric keys to enter a threshold or limit value and press the **dBm** unit soft key or the **ENTER** hard key to complete the input.

Measurement Example

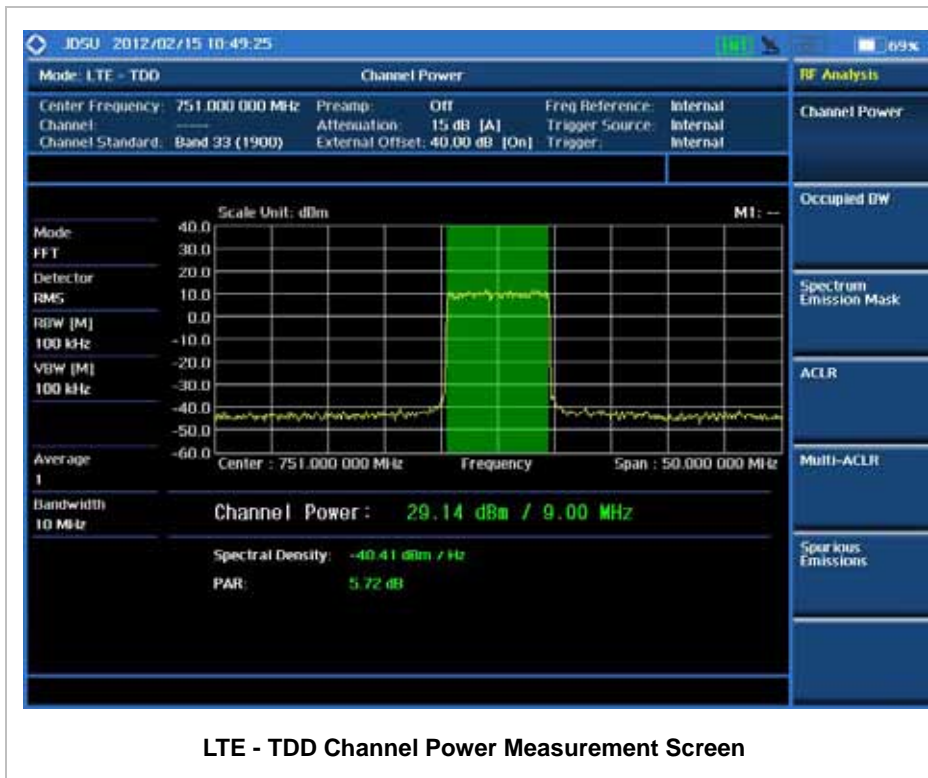

OCCUPIED BANDWIDTH

The Occupied Bandwidth measures the spectrum shape of the carrier. It is defined as the bandwidth which includes 99% of the transmitted power among total transmitted power.

Measurement Procedure

| Step | Description |
|--|--|
| 1. Set the measurement mode MEASURE [RF Analysis] [Occupied BW] | Press the MEASURE hot key. Press the RF Analysis soft key. Press the Occupied BW soft key. |
| 2. Set the measurement parameters MEASURE SETUP [Bandwidth] [1.4 MHz], [3 MHz], [5 MHz], [10 MHz], [15 MHz], or [20 MHz] [Subframe No] | Press the MEASURE SETUP hot key. Press the Bandwidth soft key. Press one of the soft keys to select. Press the Subframe No soft key. |

| | |
|---|--|
| Enter a value [Enter] | Use the numeric keys to input value. Press the Enter soft key to complete the input. |
| [Cell ID] <Auto> or <Manual> Enter a value [Enter] | Press the Cell ID soft key. Toggle between Auto and Manual . Use the numeric keys to set the Cell ID manually. Press the Enter soft key. |

LTE - TDD Occupied BW Measurement Procedure

MEASURE SETUP



- n **BANDWIDTH:** Selects the nominal channel bandwidth to be measured among **1.4 MHz, 3 MHz, 5 MHz, 10 MHz, 15 MHz,** and **20 MHz.**
- n **SUBFRAME NO:** Sets the subframe number to be measured.
- n **CELL ID:** Enables or disables automatic detection of the Cell ID of the transmitted LTE signal. Manually setting the Cell ID to a specific one can speed up to get synchronization with BTS.
 - Y **AUTO:** Detects the Cell ID automatically.
 - Y **MANUAL:** Sets the Cell ID to a specific one.

Setting Limit

LIMIT



This hot key is used to set the threshold value for the limit line on the display screen. It turns on or off the limit or band limit settings of the measurement for pass/fail indication. The user input window must be inactive first to get the Limit hot key function other than the number input.

| Step | Description |
|--|--|
| 1. Select the limit LIMIT [RF Test Limits] [Occupied BW] [Test Limit] <On> or <Off> [High Limit] Enter a value [MHz], [kHz], or [Hz] | Press the LIMIT hot key. Press the RF Test Limits soft key. Press the Occupied BW soft key. Press the Test Limit soft key to toggle between On and Off and select one. Press the High Limit soft key to set the upper limit of the Pass/Fail criteria. Use the numeric keys to input value. Press the unit soft key to select. |

| | |
|--|---|
| <p>2. Enable beep</p> <p>LIMIT</p> <p>[Beep]</p> <p><On> or <Off></p> | <p>Press the LIMIT hot key.</p> <p>Press the Beep soft key to toggle between On and Off and select one. This will make audible alarm if the measurement result goes beyond the limit.</p> |
|--|---|

- n **TEST LIMIT:** Enables or disables Pass/Fail results on the display screen. Toggle the **Test Limit** soft key to set it to **On** or **Off**.
- n **HIGH LIMIT:** Sets the upper limit of the Pass/Fail criteria. Use the numeric keys to enter a threshold or limit value and press one of the unit soft keys to complete the input.

Measurement Example

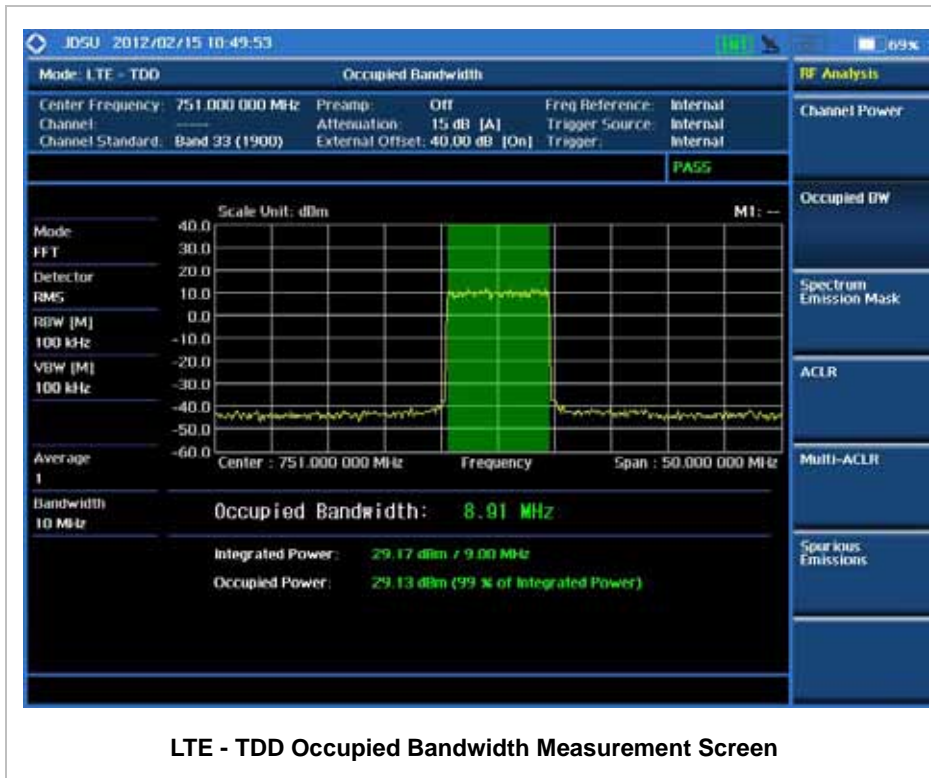

SPECTRUM EMISSION MASK (SEM)

The Spectrum Emission Mask (SEM) measurement compares the total power level within the defined carrier bandwidth and the given offset channels according to the standards.

Measurement Procedure

| Step | Description |
|---|---|
| 1. Set the measurement mode MEASURE [RF Analysis] [Spectrum Emission Mask] | Press the MEASURE hot key. Press the RF Analysis soft key. Press the Spectrum Emission Mask soft key. |
| 2. Set the measurement parameters MEASURE SETUP [Bandwidth] [1.4 MHz], [3 MHz], [5 MHz], [10 MHz], [15 MHz], or [20 MHz] [Mask Type] [Wide Area BS Category A], [Wide Area BS Category B], [Local Area BS], or [Home BS] [Subframe No] Enter a value [Enter] [Cell ID] <Auto> or <Manual> Enter a value [Enter] | Press the MEASURE SETUP hot key. Press the Bandwidth soft key. Press one of the soft keys to select. Press the Mask Type soft key. Press one of the soft keys to select. Press the Subframe No soft key. Use the numeric keys to input value. Press the Enter soft key to complete the input. Press the Cell ID soft key. Toggle between Auto and Manual . Use the numeric keys to set the Cell ID manually. Press the Enter soft key. |

LTE - TDD Spectrum Emission Mask Measurement Procedure

MEASURE SETUP



- n **BANDWIDTH:** Selects the nominal channel bandwidth to be measured among **1.4 MHz, 3 MHz, 5 MHz, 10 MHz, 15 MHz, and 20 MHz**.
- n **MASK TYPE:** Selects the mask type among **Wide Area BS Category A, Wide Area BS Category B, Local Area BS, and Home BS**.
- n **SUBFRAME NO:** Sets the subframe number to be measured.
- n **CELL ID:** Enables or disables automatic detection of the Cell ID of the transmitted LTE signal. Manually setting the Cell ID to a specific one can speed up to get synchronization with BTS.
 - Y **AUTO:** Detects the Cell ID automatically.
 - Y **MANUAL:** Sets the Cell ID to a specific one.

Setting Limit



This hot key is used to set the threshold value for the limit line on the display screen. It turns on or off the limit or band limit settings of the measurement for pass/fail indication. The user input window must be inactive first to get the Limit hot key function other than the number input.

| Step | Description |
|--|--|
| 1. Select the limit LIMIT [RF Test Limits] [Spectrum Emission Mask] [Test Limit] <On> or <Off> | Press the LIMIT hot key. Press the RF Test Limits soft key. Press the Spectrum Emission Mask soft key. Press the Test Limit soft key to toggle between On and Off and select one. |
| 2. Enable beep LIMIT [Beep] <On> or <Off> | Press the LIMIT hot key. Press the Beep soft key to toggle between On and Off and select one. This will make audible alarm if the measurement result goes beyond the limit. |

- n **TEST LIMIT:** Enables or disables Pass/Fail results on the display screen. Toggle the **Test Limit** soft key to set it to **On** or **Off**.

Measurement Example

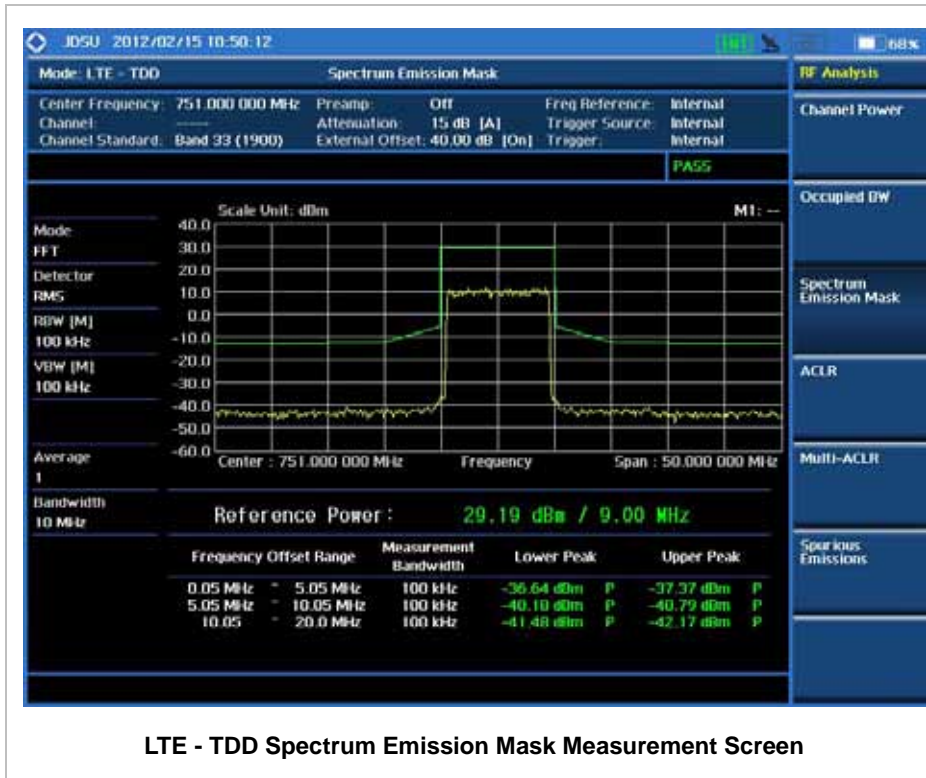

LTE - TDD Spectrum Emission Mask Measurement Screen

ACLR

The Adjacent Channel Leakage power Ratio (ACLR) measures the amount of interference or power in an adjacent frequency channel according to the standards.

Measurement Procedure

| Step | Description |
|--|--|
| 1. Set the measurement mode MEASURE [RF Analysis] [ACLR] | Press the MEASURE hot key. Press the RF Analysis soft key. Press the ACLR soft key. |
| 2. Set the measurement parameters MEASURE SETUP [Bandwidth] [1.4 MHz], [3 MHz], [5 MHz], [10 MHz], [15 MHz], or [20 MHz] [Subframe No] | Press the MEASURE SETUP hot key. Press the Bandwidth soft key. Press one of the soft keys to select. Press the Subframe No soft key. |

| | |
|---|--|
| Enter a value [Enter] | Use the numeric keys to input value. Press the Enter soft key to complete the input. |
| [Cell ID] <Auto> or <Manual> Enter a value [Enter] | Press the Cell ID soft key. Toggle between Auto and Manual . Use the numeric keys to set the Cell ID manually. Press the Enter soft key. |

LTE - TDD ACLR Measurement Procedure

MEASURE SETUP



- n **BANDWIDTH:** Selects the nominal channel bandwidth to be measured among **1.4 MHz, 3 MHz, 5 MHz, 10 MHz, 15 MHz, and 20 MHz.**
- n **SUBFRAME NO:** Sets the subframe number to be measured.
- n **CELL ID:** Enables or disables automatic detection of the Cell ID of the transmitted LTE signal. Manually setting the Cell ID to a specific one can speed up to get synchronization with BTS.
 - Y **AUTO:** Detects the Cell ID automatically.
 - Y **MANUAL:** Sets the Cell ID to a specific one.

Setting Limit

LIMIT



This hot key is used to set the threshold value for the limit line on the display screen. It turns on or off the limit or band limit settings of the measurement for pass/fail indication. The user input window must be inactive first to get the Limit hot key function other than the number input.

| Step | Description |
|--|--|
| 1. Select the limit LIMIT [RF Test Limits] [ACLR] [Test Limit] <On> or <Off> | Press the LIMIT hot key. Press the RF Test Limits soft key. Press the ACLR soft key. Press the Test Limit soft key to toggle between On and Off and select one. |
| 2. Enable beep LIMIT [Beep] <On> or <Off> | Press the LIMIT hot key. Press the Beep soft key to toggle between On and Off and select one. This will make audible alarm if the measurement result goes beyond the limit. |

- n **TEST LIMIT:** Enables or disables Pass/Fail results on the display screen. Toggle the **Test Limit** soft key to set it to **On** or **Off**.

Measurement Example

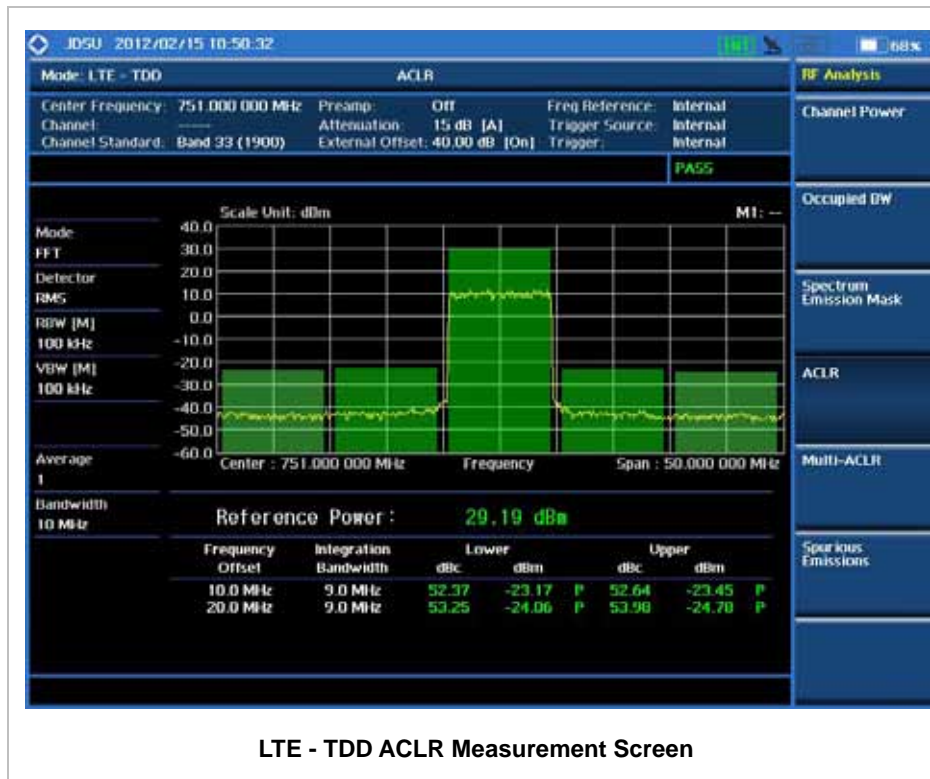

MULTI-ACLR

The Multi-ACLR measurement is used to perform multi-channel ACLR measurements with as many channels as possible. It helps the user to measure ACLR in multi-channel transmitting Base Station environment.

Measurement Procedure

| Step | Description |
|--|--|
| 1. Set the measurement mode MEASURE [RF Analysis] [Multi-ACLR] | Press the MEASURE hot key. Press the RF Analysis soft key. Press the Multi-ACLR soft key. |

| | |
|---|---|
| <p>2. Set the measurement parameters</p> <p>MEASURE SETUP</p> <p>[Unit] <Freq> or <Channel></p> <p><i>When Freq is selected:</i></p> <p>[Lowest Frequency] Enter a value [GHz], [MHz], [kHz], or [Hz]</p> <p>[Highest Frequency] Enter a value [GHz], [MHz], [kHz], or [Hz]</p> <p><i>When Channel is selected:</i></p> <p>[Channel Standard] Select a channel standard</p> <p>[Select] or ENTER</p> <p>[Lowest Channel] Enter a value [Forward]</p> <p>[Highest Channel] Enter a value [Forward]</p> <p>[Bandwidth] [1.4 MHz], [3 MHz], [5 MHz], [10 MHz], [15 MHz], or [20 MHz]</p> | <p>Press the MEASURE SETUP hot key.</p> <p>Press the Unit soft key. Toggle this key between Freq and Channel. A set of Freq/Dist screen menu changes accordingly.</p> <p>Press the Lowest Frequency soft key. Use the numeric keys to input value. Press one of the unit soft keys to select.</p> <p>Press the Highest Frequency soft key. Use the numeric keys to input value. Press one of the unit soft keys to select.</p> <p>Press the Channel Standard soft key. If this channel standard shows its default setting Band Global, go set the channel number directly. Press the arrow keys, rotate the knob, or press the Page Up and Page Down soft keys to highlight a frequency band to select.</p> <p>Press the Select soft key or the ENTER hard key.</p> <p>Press the Lowest Channel soft key. Use the numeric keys to input value. Press the Forward soft key.</p> <p>Press the Highest Channel soft key. Use the numeric keys to input value. Press the Forward soft key.</p> <p>Press the Bandwidth soft key. Press one of the soft keys to select.</p> |
|---|---|

LTE - TDD Multi-ACLR Measurement Procedure

MEASURE SETUP



- n **LOWEST FREQUENCY:** Sets the center frequency of the far left end on the display. Use the numeric keys to enter a value and press one of the unit soft keys to complete the input.
- n **HIGHEST FREQUENCY:** Sets the center frequency of the far right end on the display. Use the numeric keys to enter a value and press one of the unit soft keys to complete the input.
- n **LOWEST CHANNEL:** Sets the channel number of the far left end on the display.

- n **HIGHEST CHANNEL:** Sets the channel number of the far right end on the display.
- n **CHANNEL STANDARD:** When the channel standard is selected from the list, the center frequency information on the display screen will be mapped accordingly to the selected channel standard. The channel standards available in the instrument are listed in the Appendix C – Band, Frequency & Channel Standard.
- n **BANDWIDTH:** Selects the nominal channel bandwidth to be measured among **1.4 MHz, 3 MHz, 5 MHz, 10 MHz, 15 MHz,** and **20 MHz.**

Setting Limit



This hot key is used to set the threshold value for the limit line on the display screen. It turns on or off the limit or band limit settings of the measurement for pass/fail indication. The user input window must be inactive first to get the Limit hot key function other than the number input.

| Step | Description |
|--|--|
| 1. Select the limit LIMIT [RF Test Limits] [Multi-ACLR] [Test Limit] <On> or <Off> | Press the LIMIT hot key. Press the RF Test Limits soft key. Press the Multi-ACLR soft key. Press the Test Limit soft key to toggle between On and Off and select one. |
| 2. Enable beep LIMIT [Beep] <On> or <Off> | Press the LIMIT hot key. Press the Beep soft key to toggle between On and Off and select one. This will make audible alarm if the measurement result goes beyond the limit. |

- n **TEST LIMIT:** Enables or disables Pass/Fail results on the display screen. Toggle the **Test Limit** soft key to set it to **On** or **Off**.

Measurement Example

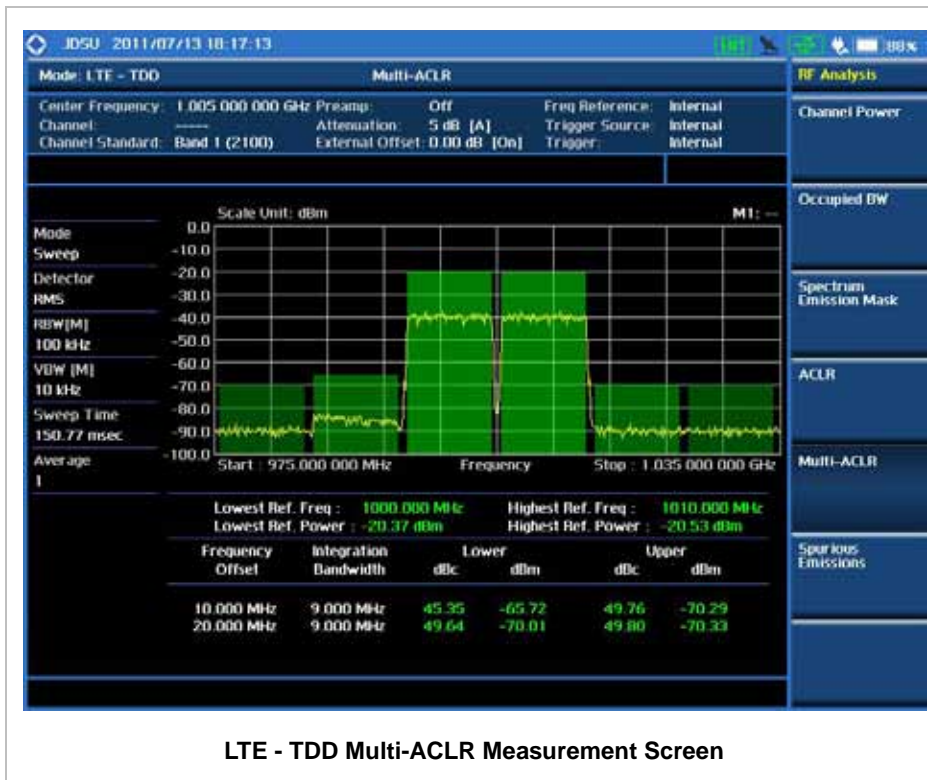

SPURIOUS EMISSIONS

Out-of-band emissions are unwanted emissions immediately outside the channel bandwidth resulting from the modulation process and non-linearity in the transmitter but excluding spurious emissions. The Spurious Emissions measurement is to identify and determine the power level of out-of-band spurious emission within the necessary channel bandwidth and modulated signal measured at the RF port of the Base Station.

Measurement Procedure

| Step | Description |
|--|--|
| 1. Set the measurement mode MEASURE [RF Analysis] [Spurious Emissions] | Press the MEASURE hot key. Press the RF Analysis soft key. Press the Spurious Emissions soft key. |
| 2. Set the measurement parameters MEASURE SETUP [Range Table] [Range] | Press the MEASURE SETUP hot key. Press the Range Table soft key. Press the Range soft key. |

| | |
|---|--|
| Enter a value [Enter] [Start Frequency] | Use the numeric keys to select the range number. Press the Enter soft key. Press the Start Frequency soft key. |
| Enter a value [GHz], [MHz], [kHz], or [Hz] [Stop Frequency] | Use the numeric keys. Press one of the unit soft keys to select. Press the Stop Frequency soft key. |
| Enter a value [GHz], [MHz], [kHz], or [Hz] [Start Limit] | Use the numeric keys. Press one of the unit soft keys to select. Press the Start Limit soft key. |
| Enter a value [dBm] [Stop Limit] | Use the numeric keys. Press the unit soft key to complete the input. Press the Stop Limit soft key. |
| Enter a value [dBm] [Attenuation] | Use the numeric keys. Press the unit soft key to complete the input. Press the Attenuation soft key. |
| Enter a value [dB] or ENTER [RBW] | Use the numeric keys to enter input value in the multiple of 5. Press the dB unit soft key or the ENTER hard key. Press the RBW soft key. |
| Enter a value [GHz], [MHz], [kHz], or [Hz] [VBW] | Use the numeric keys. Press one of the unit soft keys to select. Press the VBW soft key. |
| Enter a value [GHz], [MHz], [kHz], or [Hz] [Measure Type] | Use the numeric keys. Press one of the unit soft keys to select. Press the Measure Type soft key to toggle between Examine and Full . |
| <Examine> or <Full> [Average] | |
| Enter a value [Enter] or ENTER | Press the Average soft key. Use the numeric keys to enter a value. Press the Enter soft key or the ENTER hard key. |

LTE - TDD Spurious Emissions Measurement Procedure

MEASURE SETUP



Sets the measurement parameters including range table and measurement type. The measurement settings can be saved and recalled as a file. Also, JDViewer, PC application software allows the user to set the parameters in the user’s computer to import into the instrument.

- n **RANGE TABLE:** Sets the range table parameters.
- Y **RANGE:** Adds a new range number or selects one of the existing range numbers to show or hide the particular frequency range in the range table at the bottom of the screen. Use the numeric keys to enter a range number and press the **Enter** soft key to complete the input.

Each time the **Range** soft key is press, it toggles between **On** and **Off**.

- Y **START FREQUENCY:** Sets or changes the start frequency value to be measured for the selected range number in the Range menu. Use the numeric keys to enter a value and press one of the unit soft keys.
- Y **STOP FREQUENCY:** Sets or changes the stop frequency value to be measured for the selected range number in the Range menu. Use the numeric keys to enter a value and press one of the unit soft keys.
- Y **START LIMIT:** Sets the start value of the limit line for the displayed range.
- Y **STOP LIMIT:** Sets the stop value of the limit line for the displayed range.
- Y **ATTENUATION:** Sets the attenuation value in the multiple of 5.
- Y **RBW:** Sets the resolution bandwidth for the selected range number in the Range menu.
- Y **VBW:** Sets the video bandwidth for the selected range number in the Range menu.
- n **MEASURE TYPE:** Sets the measurement type to **Examine** or **Full**. Toggle between **Examine** and **Full**. Examine mode will show selected range only. The instrument will automatically switch and show all ranges when Full is selected.
- n **RANGE:** Selects the range number to be displayed on the screen. This key is activated only when the **Measure Type** is set to **Examine** mode. Use the numeric keys to select one of the existing range numbers that are configured in the Range Table menu. Pressing the **Enter** soft key completes the input and changes the display.
- n **AVERAGE:** Sets the frequency the number of trace to be averaged.

Setting Limit



This hot key is used to set the threshold value for the limit line on the display screen. It turns on or off the limit or band limit settings of the measurement for pass/fail indication. The user input window must be inactive first to get the Limit hot key function other than the number input.

| Step | Description |
|--|--|
| 1. Select the limit LIMIT [RF Test Limits] [Spurious Emissions] [Test Limit] <On> or <Off> | Press the LIMIT hot key. Press the RF Test Limits soft key. Press the Spurious Emissions soft key. Press the Test Limit soft key to toggle between On and Off and select one. |

| | |
|--|---|
| <p>2. Enable beep</p> <p>LIMIT</p> <p>[Beep]</p> <p><On> or <Off></p> | <p>Press the LIMIT hot key.</p> <p>Press the Beep soft key to toggle between On and Off and select one. This will make audible alarm if the measurement result goes beyond the limit.</p> |
|--|---|

- n **TEST LIMIT:** Enables or disables Pass/Fail results on the display screen. Toggle the **Test Limit** soft key to set it to **On** or **Off**.

Measurement Example

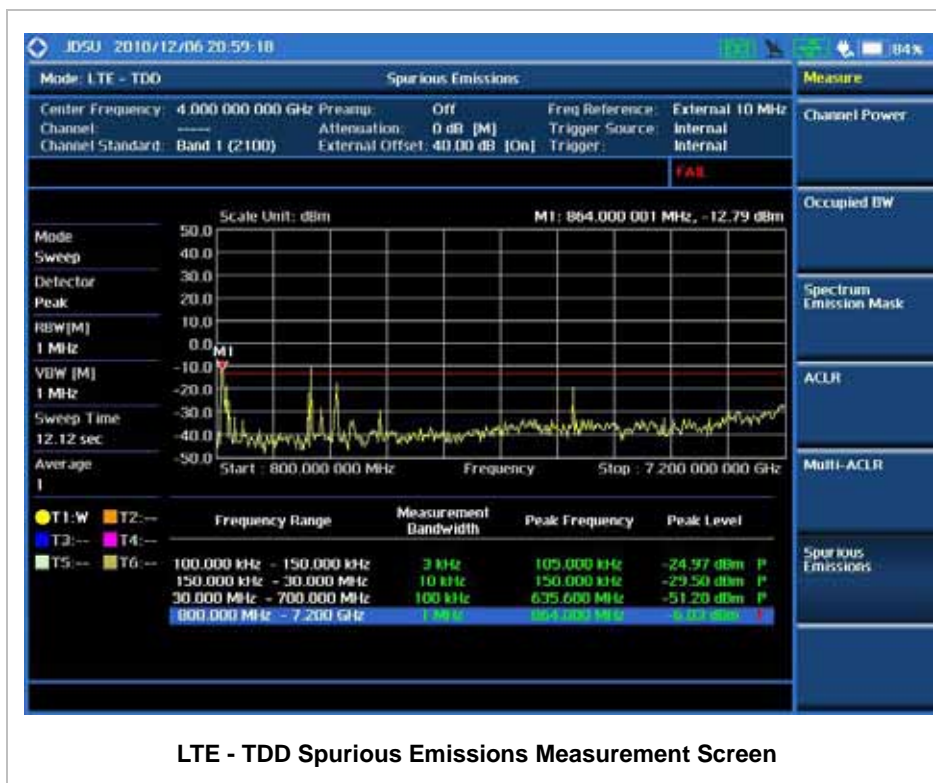

POWER VS TIME ANALYSIS MEASUREMENTS

The Power vs Time measurement measures the modulation envelope in the time domain, showing the signal rise and fall shape of LTE signal and the power of each time slot in an LTE signal.

LTD -TDD Power vs Time measurement provides following measurements.

- n Power vs Time (Slot)
- n Power vs Time (Frame)

Setting Mode

| Step | Description |
|---|--|
| 1. Connect the cable | Connect a cable directly or indirectly as shown in the section Connecting a Cable on page 8 of this chapter. |
| 2. Select the mode MODE [Signal Analyzer] [LTE - TDD] [Power vs Time (Slot)] or [Power vs Time (Frame)] | Press the MODE hard key. Press the Signal Analyzer soft key. Press the LTE - TDD soft key. Press one of the soft keys to select. |

Setting Frequency

| Step | Description |
|---|---|
| 1. Set the frequency FREQ/DIST [Unit] <Freq> or <Channel> | Press the FREQ/DIST hard key. Press the Unit soft key. Toggle this key between Freq and Channel . A set of Freq/Dist screen menu changes accordingly. |
| <i>When Freq is selected:</i> [Center Frequency] Enter a value [GHz], [MHz], [kHz], or [Hz] | Press the Center Frequency soft key. Use the numeric keys, the rotary knob, or the arrow keys. When using the numeric keys, the input is completed by selecting one of the unit soft keys. |
| <i>When Channel is selected:</i> [Channel Standard] Select a channel standard [Select] or ENTER | Press the Channel Standard soft key. If this channel standard shows its default setting Band Global, go set the channel number directly. Press the arrow keys, rotate the knob, or press the Page Up and Page Down soft keys to highlight a frequency band to select. Press the Select soft key or the ENTER hard key. |
| [Channel Number] Enter a value [Forward] | Press the Channel Number soft key. Use the numeric keys to input value and press the Forward soft key to complete the input. The instrument automatically displays its corresponding center frequency value for the channel number. |

FREQ/DIST



- n **UNIT:** Determines the way how to set the frequency band either with standard band or custom frequency band. Toggling this key between **Freq** and **Channel** changes a set of Freq/Dist screen menu automatically. When the **Channel** is selected, the instrument sets the **Channel Standard** setting to **Band Global** as default so that the user can set the **Channel Number** directly without choosing a standard channel band from the list.
- n **CENTER FREQUENCY:** Changes the center frequency setting. Use the rotary knob or the arrow keys. Or use the numeric keys to input a certain value and press one of the unit soft keys to complete the input.
- n **FREQUENCY STEP:** Defines the amount of frequency to be increased or decreased when using the rotary knob or the arrow keys to change the **Center Frequency**. This frequency step size can be entered by using numeric keys and the unit soft keys.
- n **CHANNEL NUMBER:** Enters a channel number. The instrument automatically displays its corresponding center frequency value for the channel number.
- n **CHANNEL STEP:** Defines the amount of channel to be increased or decreased when using the rotary knob or the arrow keys to change the **Channel Number**. This channel step size can be entered by using numeric keys and the **Enter** soft key.
- n **CHANNEL STANDARD:** When the channel standard is selected from the list, the center frequency information on the display screen will be mapped accordingly to the selected channel standard. The channel standards available in the instrument are listed in the Appendix C – Band, Frequency & Channel Standard.

Setting Amplitude

| Step | Description |
|---|---|
| 1. Set the reference/attenuation level AMP/SCALE [Auto Scale] or [Reference Level] Enter a reference level value [dBm] or ENTER [Attenuation] | Press the AMP/SCALE hard key. Press the Auto Scale soft key to automatically set optimum levels of reference and attenuation. Press the Reference Level soft key to set manually. Use the numeric keys or the rotary knob that changes in a 10 dB step. Press the dBm soft key or the ENTER hard key. Press the Attenuation soft key. The Auto mode is set by |

| | |
|---|---|
| <p><Manual></p> <p>Enter an attenuation value</p> | <p>default. This key toggles between the Auto and Manual.</p> <p>Press the Attenuation soft key to highlight the Manual mode and change the attenuation value to optimize S/N.</p> <p>Use the numeric keys or the rotary knob that changes in a 5 dB step. The attenuation setting range is 0 to 50 dB.</p> |
|---|---|

AMP/SCALE



- n **AUTO SCALE:** The instrument can automatically set the scale to the minimum and maximum values on the Y-axis of the graph for optimum display of the traces measured. Each time the **Auto Scale** is selected, the top and bottom scales are set to the minimum and maximum values with margin on the Y-axis of the display screen.
- n **REFERENCE LEVEL:** Sets the maximum Y-axis range.
- n **ATTENUATION**
 - Y **AUTO:** Input attenuator's value is automatically set depending on the reference level. This is the default operation mode, so it is recommended to use this mode unless a special measurement condition is needed.
 - Y **MANUAL:** Sets the attenuator's value for the **Spectrum Analyzer RF In 50 Ω** port.
- n **PREAMP:** Turns on or off the internal pre-amplifier. Preamp results in a correction being applied to compensate for the gain of the preamp so that amplitude readings show the value at the input connector. This soft key toggles between the **On** and **Off**. When it is set to On, the allowable attenuation input range is from 0 dB to 10 dB in a multiple of 5. If the attenuation value is manually set greater than 10 dB, the instrument will automatically turn off the pre-amplifier to display low level signal properly on the screen.
- n **EXTERNAL OFFSET:** Sets an external offset value. An offset consists of a cable loss and a user offset and the measurement result shows the value reflecting both offset values. When the external offset value is set at 40 dB in the Spectrum mode, the measurement result compensates 40 dB at both the Spectrum Analyzer and Signal Analyzer modes.

Setting Sweep Mode

SWEEP



This hot key is used to set the sweep parameters. The user input window must be inactive first to get the Sweep hot key function other than the number input.

- n **SWEEP MODE:** Sets the sweep method. Toggle between **Continue** and **Single**.

| Step | Description |
|---|---|
| 1. Set the sweep mode SWEEP [Sweep Mode] | Press the SWEEP hot key. Press the Sweep Mode soft key. Toggle between Continue and Single . |

Setting Trigger Source

TRIGGER

This hot key is used to select the trigger source among **Internal**, **External**, and **GPS**. The user input window must be inactive first to get the Trigger hot key function other than the number input.

Setting External Clock

To enhance the reliability of modulation analysis measurements the JD740A series must be synchronized with the Base Station. When an external clock is not supplied, the JD740A series works with a built-in internal high-accuracy time base. In this case, some measurement results may exhibit inaccurate values. Therefore, it is highly recommended to use the same reference clock as signal source. Trigger mode can be changed by using the **TRIGGER** hot key.

EXTERNAL CLOCK OPERATING STANDARDS

| Clock | Type | Reference | Port | Switching Standard |
|--------------------|----------|--------------------|---------------|--|
| External Reference | Internal | Internal 10 MHz | | Default |
| | External | External Ref Clock | Ext Ref (SMA) | Manual switching (Input signal level >-3 dBm) |
| | GPS | GPS Clock | GPS (SMA) | Automatic switching (GPS signal received) |
| Trigger | Internal | Internal Trigger | | Default |
| | External | External Trigger | Trigger (SMA) | Manual switching |
| | GPS | GPS | GPS (SMA) | Manual switching |

CONNECTION

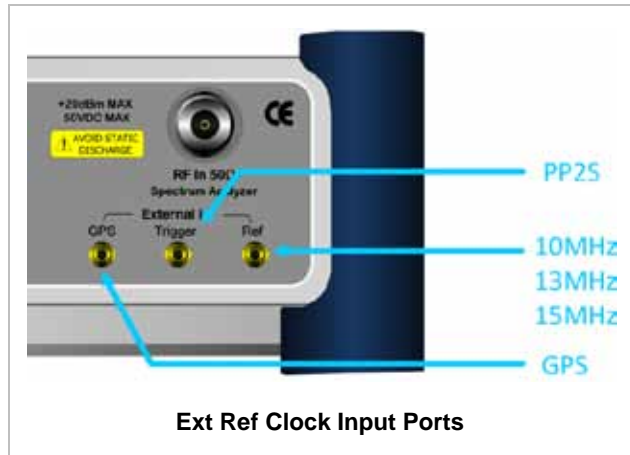

Ext Ref Clock Input Ports

ENABLING EXTERNAL REFERENCE

| Step | Description |
|---|--|
| 1. Connect an external reference | Connect one of the external references or a GPS antenna to the JD740A series. |
| 2. Change reference clock SYSTEM [Frequency Reference] [External 10 MHz], [External 13 MHz], [External 15 MHz] or [GPS] | Press the SYSTEM hot key. Press the Frequency Reference soft key to select one of the external reference clocks or GPS. Press one of the soft keys to choose among External 10 MHz , External 13 MHz , External 15 MHz , and GPS . |

EXTERNAL REFERENCE INDICATOR INFORMATION

Each indicator tells different locking status according to a connection. When a GPS antenna is connected, longitude and latitude information will be displayed on the screen.

| Type | Indicator | Description |
|----------|--|----------------------------------|
| Internal |  (Green) | Locked |
| External |  (Green) | Locked |
| |  (Red) | Unlocked |
| GPS |  (Green) | Locked |
| |  (Yellow) | Locking in progress |
| |  (Gray) | Unable to lock or antenna failed |

POWER VS TIME (SLOT)

The Power vs Time (Slot) in LTE - TDD Signal Analyzer measures the modulation envelope in the time domain, showing the signal rise and fall shape of LTE signal.

Measurement Procedure

| Step | Description |
|--|---|
| 1. Set the measurement mode MEASURE [Power vs Time] [Power vs Time (Slot)] | Press the MEASURE hot key. Press the Power vs Time soft key. Press the Power vs Time (Slot) soft key. |
| 2. Set the measurement parameters MEASURE SETUP [Bandwidth] [1.4 MHz], [3 MHz], [5 MHz], [10 MHz], [15 MHz], or [20 MHz] [Slot No] Enter a value [Enter] or [ENTER] [Cell ID] <Auto> or <Manual> Enter a value [Enter] | Press the MEASURE SETUP hot key. Press the Bandwidth soft key. Press one of the soft keys to select. Press the Slot No soft key. Use the numeric keys to input value between 0 and 19. Press the Enter soft key or the ENTER soft key to complete the input. Press the Cell ID soft key. Toggle between Auto and Manual to select one. Use the numeric keys to set the Cell ID manually. Press the Enter soft key. |

LTE - TDD Power vs Time (Slot) Measurement Procedure

MEASURE SETUP



- n **BANDWIDTH:** Selects the nominal channel bandwidth to be measured among **1.4 MHz, 3 MHz, 5 MHz, 10 MHz, 15 MHz, and 20 MHz.**
- n **SLOT NO:** Sets the slot number to be measured between 0 and 19.
- n **CELL ID:** Enables or disables automatic detection of the Cell ID of the transmitted LTE signal. Manually setting the Cell ID to a specific one can speed up to get synchronization with BTS.
- n **MISCELLANEOUS**
 - Y **ANTENNA PORT:** Sets the antenna port number automatically or manually. Each time this

soft key is pressed, selection changes among **Auto**, **0**, and **1**.

- Y **DELAY**: Sets the delay in micro seconds. This key is used only when there is a time offset in the signals to be measured.

Setting Limit



This hot key is used to set the threshold value for the limit line on the display screen. It turns on or off the limit or band limit settings of the measurement for pass/fail indication. The user input window must be inactive first to get the Limit hot key function other than the number input.

| Step | Description |
|--|---|
| 1. Select the limit LIMIT [PvsT Test Limits] [Slot Avg Power] [Test Limits] <On> or <Off> [High Limit] [Low Limit] [Off Power] [Test Limits] <On> or <Off> [High Limit] [Transition Period] [Test Limits] <On> or <Off> [High Limit] | Press the LIMIT hot key. Press the PvsT Test Limits soft key. Press the Slot Avg Power soft key. Press the Test Limits soft key. Toggle between On and Off . Use the numeric keys and input a number in ppm. Use the numeric keys and input a number in ppm. Press the Off Power soft key. Press the Test Limits soft key. Toggle between On and Off . Press the High Limit soft key to input value. Press the Transition Period soft key. Press the Test Limits soft key. Toggle between On and Off . Press the High Limit soft key to input value. |
| 2. Enable beep LIMIT [Beep] <On> or <Off> | Press the LIMIT hot key. Press the Beep soft key to toggle between On and Off and select one. This will make audible alarm if the measurement result goes beyond the limit. |

- n **SLOT AVG POWER**: Sets the slot average power limit.

- Y **TEST LIMITS**: Enables or disables the test limit(s). Toggle the **Test Limits** soft key between **On** and **Off**.

- Y **HIGH LIMIT:** Sets the upper limit. Use the numeric keys to input value and press the unit soft key or the **ENTER** hard key to complete the input.
- Y **LOW LIMIT:** Sets the lower limit. Use the numeric keys to input value and press the unit soft key or the **ENTER** hard key to complete the input.
- n **OFF POWER:** Sets the off power limit.
- Y **TEST LIMITS:** Enables or disables the test limit. Toggle this soft key between **On** and **Off**.
- Y **HIGH LIMIT:** Sets the upper limit of the off power. Use the numeric keys to input value and press the unit soft key or the **ENTER** hard key to complete the input.
- n **TRANSITION PERIOD:** Sets the transition period limit.
- Y **TEST LIMITS:** Enables or disables the test limit. Toggle this soft key between **On** and **Off**.
- Y **HIGH LIMIT:** Sets the upper limit of the transition period. Use the numeric keys to input value and press the unit soft key or the **ENTER** hard key to complete the input.

Measurement Example

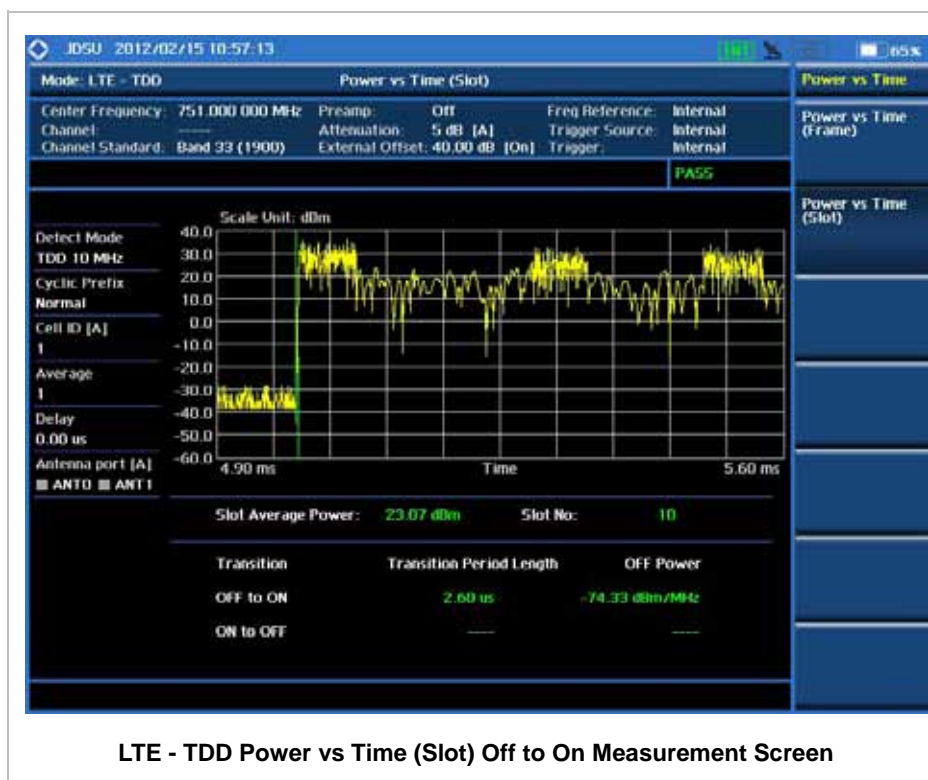

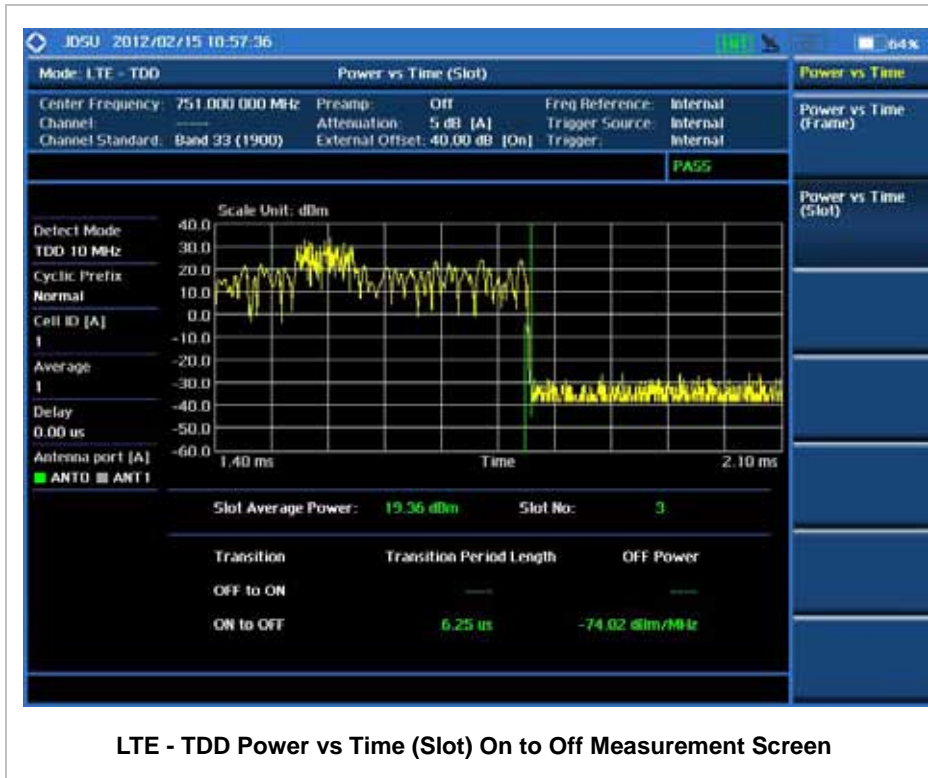

LTE - TDD Power vs Time (Slot) On to Off Measurement Screen

POWER VS TIME (FRAME) MEASUREMENT

The Power vs Time (Frame) in LTE - TDD Signal Analyzer measures the modulation envelope in the time domain, showing the power of each time slot in an LTE signal.

Measurement Procedure

| Step | Description |
|---|--|
| 1. Set the measurement mode MEASURE [Power vs Time (Frame)] | Press the MEASURE hot key. Press the Power vs Time (Frame) soft key. |
| 2. Set the measurement parameters MEASURE SETUP [Bandwidth] [1.4 MHz], [3 MHz], [5 MHz], [10 MHz], [15 MHz], or [20 MHz] [Subframe No] Enter a value | Press the MEASURE SETUP hot key. Press the Bandwidth soft key. Press one of the soft keys to select. Press the Subframe No soft key. Use the numeric keys to input value. |

| | |
|---|---|
| [Enter] | Press the Enter soft key to complete the input. |
| [Cell ID] <Auto> or <Manual> Enter a value [Enter] | Press the Cell ID soft key. Toggle between Auto and Manual to select one. Use the numeric keys to set the Cell ID manually. Press the Enter soft key. |

LTE - TDD Power vs Time (Frame) Measurement Procedure

MEASURE SETUP



- n **BANDWIDTH:** Selects the nominal channel bandwidth to be measured among **1.4 MHz, 3 MHz, 5 MHz, 10 MHz, 15 MHz,** and **20 MHz.**
- n **SUBFRAME NO:** Sets the subframe number to be measured.
- n **CELL ID:** Enables or disables automatic detection of the Cell ID of the transmitted LTE signal. Manually setting the Cell ID to a specific one can speed up to get synchronization with BTS.
 - Y **AUTO:** Detects the Cell ID automatically.
 - Y **MANUAL:** Sets the Cell ID to a specific one.
- n **MISCELLANEOUS**
 - Y **ANTENNA PORT:** Sets the antenna port number automatically or manually. Each time this soft key is pressed, selection changes among **Auto, 0,** and **1.**
 - Y **DELAY:** Sets the delay in micro seconds. This key is used only when there is a time offset in the signals to be measured.

Measurement Example

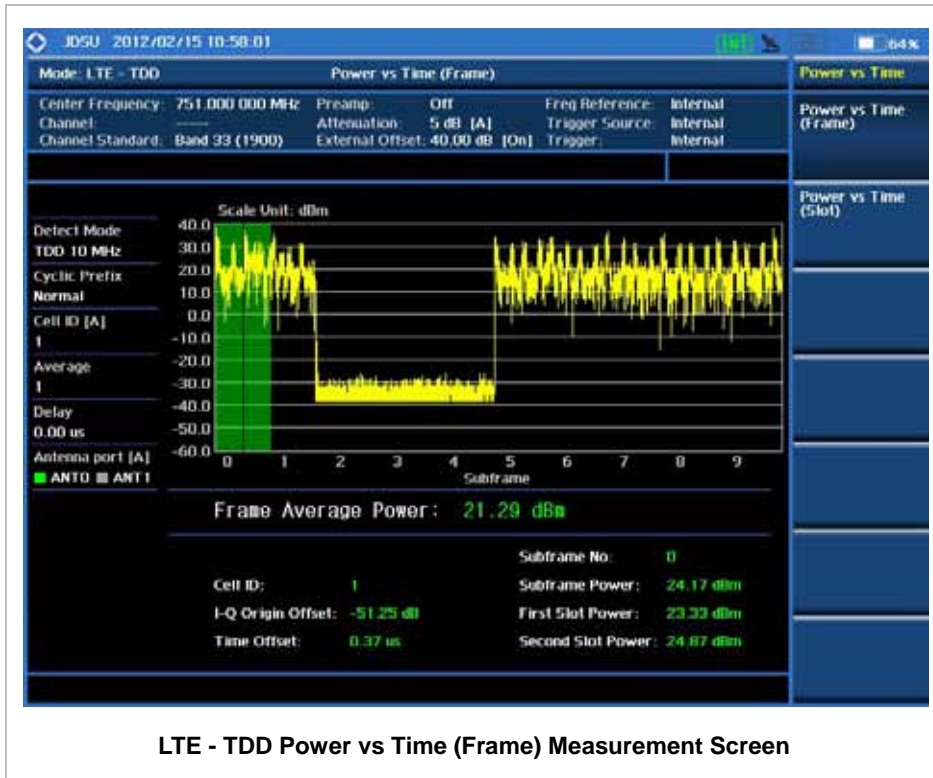

MODULATION ANALYSIS MEASUREMENTS

Modulation Analysis in LTE - TDD Signal Analyzer provides single-button measurements for the following essential measurements.

- n Constellation
- n Data Channel
- n Control Channel
- n Subframe
- n Time Alignment Error
- n Data Allocation Map

Setting Mode

| Step | Description |
|----------------------|--|
| 1. Connect the cable | Connect a cable directly or indirectly as shown in the section Connecting a Cable on page 8 of this chapter. |

| | |
|---|--|
| <p>2. Select the mode</p> <p>MODE</p> <p>[Signal Analyzer]</p> <p>[LTE - TDD]</p> <p>[Modulation Analysis]</p> <p>[Constellation],</p> <p>[Data Channel],</p> <p>[Control Channel],</p> <p>[Subframe],</p> <p>[Time Alignment Error], or</p> <p>[Data Allocation Map]</p> | <p>Press the MODE hard key.</p> <p>Press the Signal Analyzer soft key.</p> <p>Press the LTE - TDD soft key.</p> <p>Press the Modulation Analysis soft key.</p> <p>Press one of the measurement mode soft keys to select.</p> |
|---|--|

Setting Frequency

| Step | Description |
|--|--|
| <p>1. Set the frequency</p> <p>FREQ/DIST</p> <p>[Unit]</p> <p><Freq> or <Channel></p> <p><i>When Freq is selected:</i></p> <p>[Center Frequency]</p> <p>Enter a value</p> <p>[GHz], [MHz], [kHz], or [Hz]</p> <p><i>When Channel is selected:</i></p> <p>[Channel Standard]</p> <p>Select a channel standard</p> <p>[Select] or ENTER</p> <p>[Channel Number]</p> <p>Enter a value</p> <p>[Forward]</p> | <p>Press the FREQ/DIST hard key.</p> <p>Press the Unit soft key. Toggle this key between Freq and Channel. A set of Freq/Dist screen menu changes accordingly.</p> <p>Press the Center Frequency soft key.</p> <p>Use the numeric keys, the rotary knob, or the arrow keys.</p> <p>When using the numeric keys, the input is completed by selecting one of the unit soft keys.</p> <p>Press the Channel Standard soft key. If this channel standard shows its default setting Band Global, go set the channel number directly.</p> <p>Press the arrow keys, rotate the knob, or press the Page Up and Page Down soft keys to highlight a frequency band to select.</p> <p>Press the Select soft key or the ENTER hard key.</p> <p>Press the Channel Number soft key.</p> <p>Use the numeric keys to input value and press the Forward soft key to complete the input. The instrument automatically displays its corresponding center frequency value for the channel number.</p> |

FREQ/DIST



- n **UNIT:** Determines the way how to set the frequency band either with standard band or custom frequency band. Toggling this key between **Freq** and **Channel** changes a set of Freq/Dist screen menu automatically. When the **Channel** is selected, the instrument sets the **Channel Standard** setting to **Band Global** as default so that the user can set the **Channel Number** directly without choosing a standard channel band from the list.
- n **CENTER FREQUENCY:** Changes the center frequency setting. Use the rotary knob or the arrow keys. Or use the numeric keys to input a certain value and press one of the unit soft keys to complete the input.
- n **FREQUENCY STEP:** Defines the amount of frequency to be increased or decreased when using the rotary knob or the arrow keys to change the **Center Frequency**. This frequency step size can be entered by using numeric keys and the unit soft keys.
- n **CHANNEL NUMBER:** Enters a channel number. The instrument automatically displays its corresponding center frequency value for the channel number.
- n **CHANNEL STEP:** Defines the amount of channel to be increased or decreased when using the rotary knob or the arrow keys to change the **Channel Number**. This channel step size can be entered by using numeric keys and the **Enter** soft key.
- n **CHANNEL STANDARD:** When the channel standard is selected from the list, the center frequency information on the display screen will be mapped accordingly to the selected channel standard. The channel standards available in the instrument are listed in the Appendix C – Band, Frequency & Channel Standard.

Setting Amplitude

| Step | Description |
|---|---|
| 1. Set the reference/attenuation level AMP/SCALE [Auto Scale] or [Reference Level] Enter a reference level value [dBm] or ENTER [Attenuation] | Press the AMP/SCALE hard key. Press the Auto Scale soft key to automatically set optimum levels of reference and attenuation. Press the Reference Level soft key to set manually. Use the numeric keys or the rotary knob that changes in a 10 dB step. Press the dBm soft key or the ENTER hard key. Press the Attenuation soft key. The Auto mode is set by |

| | |
|---|---|
| <p><Manual></p> <p>Enter an attenuation value</p> | <p>default. This key toggles between the Auto and Manual.</p> <p>Press the Attenuation soft key to highlight the Manual mode and change the attenuation value to optimize S/N.</p> <p>Use the numeric keys or the rotary knob that changes in a 5 dB step. The attenuation setting range is 0 to 50 dB.</p> |
|---|---|

AMP/SCALE



- n **AUTO SCALE:** The instrument can automatically set the scale to the minimum and maximum values on the Y-axis of the graph for optimum display of the traces measured. Each time the **Auto Scale** is selected, the top and bottom scales are set to the minimum and maximum values with margin on the Y-axis of the display screen.
- n **REFERENCE:** Sets the display of measurement result to relative or absolute value. Toggle between **Abs** for absolute and **Rel** for relative. *This key is not used in the Data Channel mode*
 - Y **ABS:** The code domain power is measured absolute to channel power.
 - Y **REL:** The code domain power is measured relative to channel power.
- n **REFERENCE LEVEL:** Sets the maximum Y-axis range. *This key is used in the Data Channel mode.*
- n **ATTENUATION**
 - Y **AUTO:** Input attenuator's value is automatically set depending on the reference level. This is the default operation mode, so it is recommended to use this mode unless a special measurement condition is needed.
 - Y **MANUAL:** Sets the attenuator's value for the **Spectrum Analyzer RF In 50 Ω** port.
- n **PREAMP:** Turns on or off the internal pre-amplifier. Preamp results in a correction being applied to compensate for the gain of the preamp so that amplitude readings show the value at the input connector. This soft key toggles between the **On** and **Off**. When it is set to On, the allowable attenuation input range is from 0 dB to 10 dB in a multiple of 5. If the attenuation value is manually set greater than 10 dB, the instrument will automatically turn off the pre-amplifier to display low level signal properly on the screen.
- n **EXTERNAL OFFSET:** Sets an external offset value. An offset consists of a cable loss and a user offset and the measurement result shows the value reflecting both offset values. When the external offset value is set at 40 dB in the Spectrum mode, the measurement result compensates 40 dB at both the Spectrum Analyzer and Signal Analyzer modes.

Setting Sweep Mode

SWEEP



This hot key is used to set the sweep parameters. The user input window must be inactive first to get the Sweep hot key function other than the number input.

- n **SWEEP MODE:** Sets the sweep method. Toggle between **Continue** and **Single**.

| Step | Description |
|---|---|
| 1. Set the sweep mode SWEEP [Sweep Mode] | Press the SWEEP hot key. Press the Sweep Mode soft key. Toggle between Continue and Single . |

Setting Trigger Source



This hot key is used to select the trigger source among **Internal**, **External**, and **GPS**. The user input window must be inactive first to get the Trigger hot key function other than the number input.

Setting External Clock

To enhance the reliability of modulation analysis measurements the JD740A series must be synchronized with the Base Station. When an external clock is not supplied, the JD740A series works with a built-in internal high-accuracy time base. In this case, some measurement results may exhibit inaccurate values. Therefore, it is highly recommended to use the same reference clock as signal source. Trigger mode can be changed by using the **TRIGGER** hot key.

EXTERNAL CLOCK OPERATING STANDARDS

| Clock | Type | Reference | Port | Switching Standard |
|--------------------|----------|--------------------|---------------|--|
| External Reference | Internal | Internal 10 MHz | | Default |
| | External | External Ref Clock | Ext Ref (SMA) | Manual switching (Input signal level >-3 dBm) |
| | GPS | GPS Clock | GPS (SMA) | Automatic switching (GPS signal received) |
| Trigger | Internal | Internal Trigger | | Default |
| | External | External Trigger | Trigger (SMA) | Manual switching |
| | GPS | GPS | GPS (SMA) | Manual switching |

CONNECTION

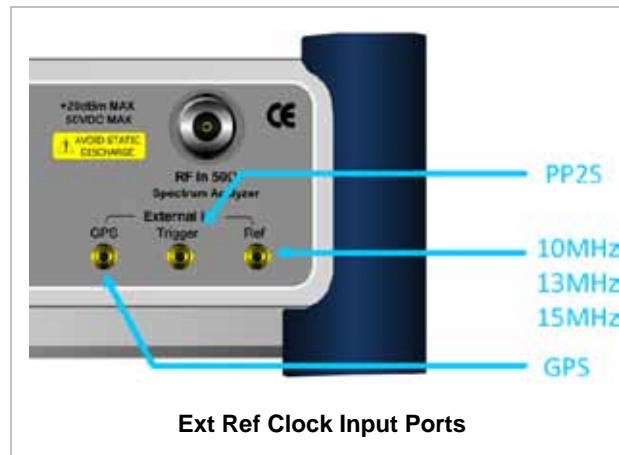

Ext Ref Clock Input Ports

ENABLING EXTERNAL REFERENCE

| Step | Description |
|--|---|
| 1. Connect an external reference | Connect one of the external references or a GPS antenna to the JD740A series. |
| 2. Change reference clock SYSTEM [Frequency Reference] [External 10 MHz], [External 13 MHz], [External 15 MHz] or [GPS] | <p>Press the SYSTEM hot key.</p> <p>Press the Frequency Reference soft key to select one of the external reference clocks or GPS.</p> <p>Press one of the soft keys to choose among External 10 MHz, External 13 MHz, External 15 MHz, and GPS.</p> |

EXTERNAL REFERENCE INDICATOR INFORMATION

Each indicator tells different locking status according to a connection. When a GPS antenna is connected, longitude and latitude information will be displayed on the screen.

| Type | Indicator | Description |
|----------|--|----------------------------------|
| Internal |  (Green) | Locked |
| External |  (Green) | Locked |
| |  (Red) | Unlocked |
| GPS |  (Green) | Locked |
| |  (Yellow) | Locking in progress |
| |  (Gray) | Unable to lock or antenna failed |

CONSTELLATION

The Constellation is used to analyze transmitter modulation performance. The JD740A series displays the constellation diagram with modulation metrics to characterize the performance.

Measurement Procedure

| Step | Description |
|---|--|
| 1. Set the measurement mode MEASURE [Modulation Analysis] [Constellation] | Press the MEASURE hot key. Press the Modulation Analysis soft key. Press the Constellation soft key. |
| 2. Set the measurement parameters MEASURE SETUP [Bandwidth] [1.4 MHz], [3 MHz], [5 MHz], [10 MHz], [15 MHz], or [20 MHz] [Subframe No] Enter a value [Enter] [PHICH Ng] [1/6], [1/2], [1], [2], [E-1/6], [E-1/2], [E-1], or [E-2] [CFI] <Auto> or <Manual> Enter a value [Enter] [Uplink-Downlink Configuration] [0], [1], [2], [3], [4], [5], or [6] [Cell ID] <Auto> or <Manual> Enter a value [Enter] | Press the MEASURE SETUP hot key. Press the Bandwidth soft key. Press one of the soft keys to select. Press the Subframe No soft key. Use the numeric keys to input value. Press the Enter soft key to complete the input. Press the PHICH Ng soft key. Select one of the soft keys to set the number of PHICH groups (Ng). Press the CFI soft key to toggle between Auto and Manual . Use the numeric keys to manually input value. Press the Enter soft key. Press the Uplink-Downlink Configuration soft key. Select one of the soft keys to choose. Press the Cell ID soft key. Toggle between Auto and Manual . Use the numeric keys to set the Cell ID manually. Press the Enter soft key. |

LTE - TDD Constellation Measurement Procedure

MEASURE SETUP



- n **BANDWIDTH:** Selects the nominal channel bandwidth to be measured among **1.4 MHz, 3 MHz, 5 MHz, 10 MHz, 15 MHz,** and **20 MHz.**
- n **SUBFRAME NO:** Sets the subframe number to be measured.
- n **CELL ID:** Enables or disables automatic detection of the Cell ID of the transmitted LTE signal. Manually setting the Cell ID to a specific one can speed up to get synchronization with BTS.
 - Y **AUTO:** Detects the Cell ID automatically.
 - Y **MANUAL:** Sets the Cell ID to a specific one.
- n **CFI:** Sets the number of OFDM symbols used for transmission of PDCCHs in a subframe. Toggle this soft key between **Auto** and **Manual**. The set of OFDM symbols that can be used for PDCCH in a subframe is given by **0, 2, 3** or **4** in 1.4 MHz bandwidth and **1, 2,** or **3** in other bandwidths.
- n **PHICH Ng:** Sets the number of PHICH groups (Ng) which is constant in all subframes. Choose the PHICH Ng among **1/6, 1/2, 1, 2, E-1/6, E-1/2, E-1,** or **E-2.**
- n **UPLINK-DOWNLINK CONFIGURATION:** Selects the number of uplink/downlink from 0 to 6.
- n **MISCELLANEOUS**
 - Y **ANTENNA PORT:** Sets the antenna port number automatically or manually. Each time this soft key is pressed, selection changes among **Auto, 0,** and **1.**
 - Y **DELAY:** Sets the delay in micro seconds. This key is used only when there is a time offset in the signals to be measured.
 - Y **CYCLIC PREFIX:** Sets the cyclic prefix to **Normal** or **Extended**. For OFDM parameter details by different bandwidth, refer to the table in the Appendix E – Cyclic Prefix Table.
 - Y **PDSCH MODULATION TYPE:** Sets the modulation type in a frame among **Auto, QPSK, 16QAM, 64QAM, E-TM3.3, E-TM3.2, E-TM3.1, E-TM2, E-TM1.2,** and **E-TM1.1.** If two or more modulation types are used in a frame, set the PDSCH Modulation Type to **Auto**. If the PDSCH uses the same modulation type in a frame or in a subframe, set it to specific modulation type to get more accurate EVM.
 - Y **PDSCH THRESHOLD:** Sets the threshold of PDSCH. Use the numeric keys to input value and press the **dB** unit soft key to complete the input.

Setting Limit

LIMIT



This hot key is used to set the threshold value for the limit line on the display screen. It turns on or off

the limit or band limit settings of the measurement for pass/fail indication. The user input window must be inactive first to get the Limit hot key function other than the number input.

| Step | Description |
|--|--|
| <p>1. Select the limit</p> <p>LIMIT</p> <p>[Modulation Test Limits]</p> <p>[Frequency Error]</p> <p>[Test Limits] <On> or <Off></p> <p>[High Limit]</p> <p>[Low Limit]</p> <p>[EVM]</p> <p>[PDSCH EVM]</p> <p>[Test Limits] <On> or <Off></p> <p>[High Limit (QPSK)]</p> <p>[High Limit (16QAM)]</p> <p>[High Limit (64QAM)]</p> <p>[Data EVM RMS]</p> <p>[Test Limits] <On> or <Off></p> <p>[High Limit]</p> <p>[Data EVM Peak]</p> <p>[Test Limits] <On> or <Off></p> <p>[High Limit]</p> <p>[Time Error]</p> <p>[Test Limits] <On> or <Off></p> <p>[High Limit]</p> <p>[Low Limit]</p> <p>[IQ Origin Offset]</p> <p>[Test Limit] <On> or <Off></p> <p>[High Limit]</p> | <p>Press the LIMIT hot key.</p> <p>Press the Modulation Test Limits soft key.</p> <p>Press the Frequency Error soft key.</p> <p>Press the Test Limits soft key. Toggle between On and Off.</p> <p>Use the numeric keys and input a number in ppm.</p> <p>Use the numeric keys and input a number in ppm.</p> <p>Press the EVM soft key.</p> <p>Press the PDSCH EVM soft key.</p> <p>Press the Test Limits soft key. Toggle between On and Off.</p> <p>Press the High Limit (QPSK) soft key to input value.</p> <p>Press the High Limit (16QAM) soft key to input value.</p> <p>Press the High Limit (64QAM) soft key to input value.</p> <p>Press the Data EVM RMS soft key.</p> <p>Press the Test Limits soft key. Toggle between On and Off.</p> <p>Press the High Limit soft key to input value.</p> <p>Press the Data EVM Peak soft key.</p> <p>Press the Test Limits soft key. Toggle between On and Off.</p> <p>Press the High Limit soft key to input value.</p> <p>Press the Time Error soft key.</p> <p>Press the Test Limits soft key. Toggle between On and Off.</p> <p>Use the numeric keys to input value.</p> <p>Use the numeric keys to input value.</p> <p>Press the IQ Origin Offset soft key.</p> <p>Press the Test Limit soft key. Toggle between On and Off.</p> <p>Use the numeric keys and input a number in dB.</p> |
| <p>2. Enable beep</p> <p>LIMIT</p> | <p>Press the LIMIT hot key.</p> |

| | |
|---|--|
| <p>[Beep] <On> or <Off></p> | <p>Press the Beep soft key to toggle between On and Off and select one. This will make audible alarm if the measurement result goes beyond the limit.</p> |
|---|--|

- n **FREQUENCY ERROR:** Sets the frequency error limit.
- Y **TEST LIMITS:** Enables or disables the test limit(s). Toggle the **Test Limits** soft key between **On** and **Off**.
- Y **HIGH LIMIT:** Sets the upper limit. Use the numeric keys to input value and press the unit soft key or the **ENTER** hard key to complete the input.
- Y **LOW LIMIT:** Sets the lower limit. Use the numeric keys to input value and press the unit soft key or the **ENTER** hard key to complete the input.
- n **EVM:** Sets limits for Error Vector Magnitude.
 - Y **PDSCH EVM:** Sets the limit of the PDSCH EVM.
 - **TEST LIMITS:** Enables or disables the test limit. Toggle this key between **On** and **Off**.
 - **HIGH LIMIT (QPSK):** Sets the upper limit of QPSK. Use the numeric keys to input value and press the unit soft key or the **ENTER** hard key to complete the input.
 - **HIGH LIMIT (16QAM):** Sets the upper limit of 16QAM. Use the numeric keys to input value and press the unit soft key or the **ENTER** hard key to complete the input.
 - **HIGH LIMIT (64QAM):** Sets the upper limit of 64QAM. Use the numeric keys to input value and press the unit soft key or the **ENTER** hard key to complete the input.
 - Y **DATA EVM RMS:** Sets the rms limit of the Data EVM.
 - **TEST LIMITS:** Enables or disables the test limit. Toggle this key between **On** and **Off**.
 - **HIGH LIMIT:** Sets the upper limit. Use the numeric keys to input value and press the unit soft key or the **ENTER** hard key to complete the input.
 - Y **DATA EVM PEAK:** Sets the peak limit of the Data EVM.
 - **TEST LIMITS:** Enables or disables the test limit. Toggle this key between **On** and **Off**.
 - **HIGH LIMIT:** Sets the upper limit. Use the numeric keys to input value and press the unit soft key or the **ENTER** hard key to complete the input.
 - Y **RS EVM:** *This key is not used in the Constellation mode.*
 - Y **P-SS EVM:** *This key is not used in the Constellation mode.*
 - Y **S-SS EVM:** *This key is not used in the Constellation mode.*
- n **POWER:** *This key is not used in the Constellation mode.*
- n **TIME ALIGNMENT ERROR:** *This key is not used in the Constellation mode.*

- n **TIME ERROR:** Sets the limit of the Time Error.
- Y **TEST LIMITS:** Enables or disables the test limits. Toggle this soft key between **On** and **Off**.
- Y **HIGH LIMIT:** Sets the upper limit. Use the numeric keys to input value and press the unit soft key or the **ENTER** hard key to complete the input.
- Y **LOW LIMIT:** Sets the lower limit. Use the numeric keys to input value and press the unit soft key or the **ENTER** hard key to complete the input.
- n **IQ ORIGIN OFFSET:** Sets the limit of I/Q origin offset.
- Y **TEST LIMIT:** Enables or disables the test limit. Toggle this soft key between **On** and **Off**.
- Y **HIGH LIMIT:** Sets the upper limit. Use the numeric keys to input value and press the unit soft key or the **ENTER** hard key to complete the input.

Measurement Example

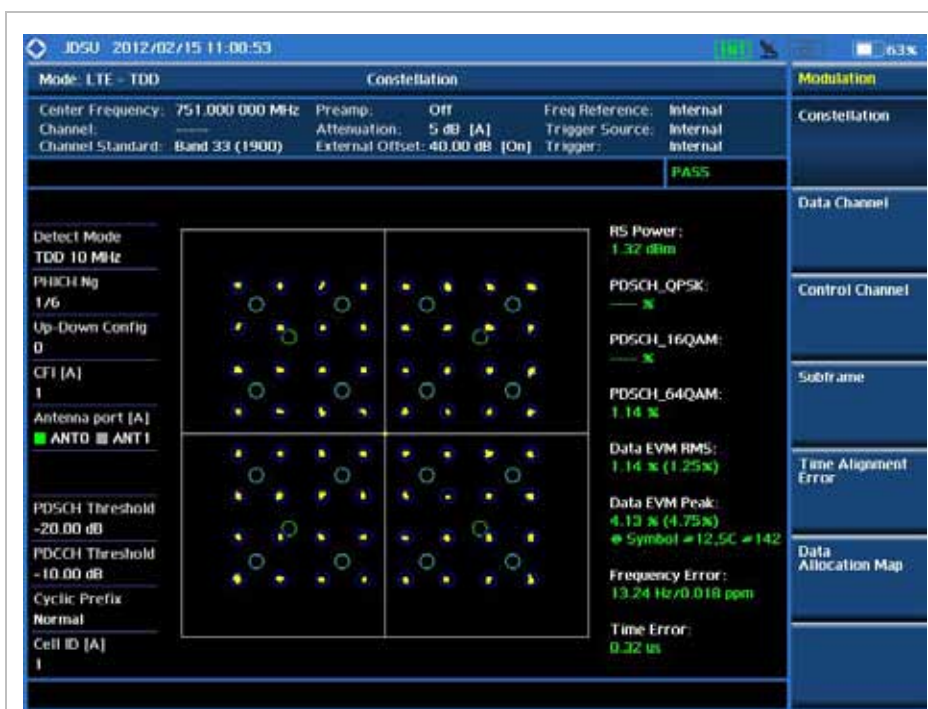

LTE - TDD Constellation Measurement Screen

DATA CHANNEL

Data Channel measures the constellation for the specified resource block as well as the modulation accuracy of each PDSCH at the specified subframe.

Measurement Procedure

| Step | Description |
|--|--|
| 1. Set the measurement mode MEASURE [Modulation Analysis] [Data Channel] | Press the MEASURE hot key. Press the Modulation Analysis soft key. Press the Data Channel soft key. |
| 2. Set the measurement parameters MEASURE SETUP [Bandwidth] [1.4 MHz], [3 MHz], [5 MHz], [10 MHz], [15 MHz], or [20 MHz] [Subframe No] Enter a value [Enter] [PHICH Ng] [1/6], [1/2], [1], [2], [E-1/6], [E-1/2], [E-1], or [E-2] [CFI] <Auto> or <Manual> Enter a value [Enter] [Uplink-Downlink Configuration] [0], [1], [2], [3], [4], [5], or [6] [Cell ID] <Auto> or <Manual> Enter a value [Enter] [Event Hold] <On> or <Off> | Press the MEASURE SETUP hot key. Press the Bandwidth soft key. Press one of the soft keys to select. Press the Subframe No soft key. Use the numeric keys to input value. Press the Enter soft key to complete the input. Press the PHICH Ng soft key. Select one of the soft keys to set the number of PHICH groups (Ng). Press the CFI soft key to toggle between Auto and Manual . Use the numeric keys to manually input value. Press the Enter soft key. Press the Uplink-Downlink Configuration soft key. Select one of the soft keys to choose. Press the Cell ID soft key. Toggle between Auto and Manual . Use the numeric keys to set the Cell ID manually. Press the Enter soft key. Press the Event Hold soft key. Toggle this key between On and Off . |

LTE - TDD Data Channel Measurement Procedure

MEASURE SETUP



- n **BANDWIDTH:** Selects the nominal channel bandwidth to be measured among **1.4 MHz, 3 MHz,**

5 MHz, 10 MHz, 15 MHz, and 20 MHz.

- n **SUBFRAME NO:** Sets the subframe number to be measured.
- n **CELL ID:** Enables or disables automatic detection of the Cell ID of the transmitted LTE signal. Manually setting the Cell ID to a specific one can speed up to get synchronization with BTS.
 - Y **AUTO:** Detects the Cell ID automatically.
 - Y **MANUAL:** Sets the Cell ID to a specific one.
- n **CFI:** Sets the number of OFDM symbols used for transmission of PDCCHs in a subframe. Toggle this soft key between **Auto** and **Manual**. The set of OFDM symbols that can be used for PDCCH in a subframe is given by **0, 2, 3** or **4** in 1.4 MHz bandwidth and **1, 2,** or **3** in other bandwidths.
- n **PHICH Ng:** Sets the number of PHICH groups (Ng) which is constant in all subframes. Choose the PHICH Ng among **1/6, 1/2, 1, 2, E-1/6, E-1/2, E-1,** or **E-2**.
- n **EVENT HOLD:** Turns the event hold function on or off. Toggle this key between **On** and **Off**. Event hold is used to put the measurement screen on hold in the event of active data measured if the Event Hold is set to On. It enables you to view detailed current resource block on the I-Q diagram, particularly in a dynamic field environment. The display screen shows the red **HOLD** on it to indicate an event on hold. To reset the current event hold, press the **Hold** hot key and the red **HOLD** indicator will disappear until the next event.
- n **UPLINK-DOWNLINK CONFIGURATION:** Selects the number of uplink/downlink from 0 to 6.
- n **MISCELLANEOUS**
 - Y **ANTENNA PORT:** Sets the antenna port number automatically or manually. Each time this soft key is pressed, selection changes among **Auto, 0,** and **1**.
 - Y **DELAY:** Sets the delay in micro seconds. This key is used only when there is a time offset in the signals to be measured.
 - Y **CYCLIC PREFIX:** Sets the cyclic prefix to **Normal** or **Extended**. For OFDM parameter details by different bandwidth, refer to the table in the Appendix E – Cyclic Prefix Table.
 - Y **PDSCH MOD TYPE:** Sets the modulation type in a frame among **Auto, QPSK, 16QAM, 64QAM, E-TM3.3, E-TM3.2, E-TM3.1, E-TM2, E-TM1.2,** and **E-TM1.1**. If two or more modulation types are used in a frame, set the PDSCH Mod Type to **Auto**. If the PDSCH uses the same modulation type in a frame or in a subframe, set it to specific modulation type to get more accurate EVM.
 - Y **PDSCH THRESHOLD:** Sets the threshold of PDSCH. Use the numeric keys to input value and press the **dB** unit soft key to complete the input.

Setting Limit

LIMIT



This hot key is used to set the threshold value for the limit line on the display screen. It turns on or off the limit or band limit settings of the measurement for pass/fail indication. The user input window must be inactive first to get the Limit hot key function other than the number input.

| Step | Description |
|---|---|
| 1. Select the limit mode LIMIT [Modulation Test Limits] [EVM] [Data EVM RMS] [Test Limits] <On> or <Off> [High Limit] [Data EVM Peak] [Test Limits] <On> or <Off> [High Limit] [IQ Origin Offset] [Test Limit] <On> or <Off> [High Limit] | Press the LIMIT hot key. Press the Modulation Test Limits soft key. Press the EVM soft key. Press the Data EVM RMS soft key. Press the Test Limits soft key. Toggle between On and Off . Press the High Limit soft key to input value. Press the Data EVM Peak soft key. Press the Test Limits soft key. Toggle between On and Off . Press the High Limit soft key to input value. Press the IQ Origin Offset soft key. Press the Test Limit soft key. Toggle between On and Off . Use the numeric keys and input a number in dB. |
| 2. Enable beep LIMIT [Beep] <On> or <Off> | Press the LIMIT hot key. Press the Beep soft key to toggle between On and Off and select one. This will make audible alarm if the measurement result goes beyond the limit. |

n **FREQUENCY ERROR:** *This key is not used in the Data Channel mode.*

n **EVM:** Sets limits for Error Vector Magnitude.

Y **PDSCH EVM:** *This key is not used in the Data Channel mode.*

Y **DATA EVM RMS:** Sets the rms limit of the Data EVM.

- **TEST LIMITS:** Enables or disables the test limit. Toggle this soft key between **On** and **Off**.
- **HIGH LIMIT:** Sets the upper limit. Use the numeric keys to input value and press the unit soft key or the **ENTER** hard key to complete the input.

- Y **DATA EVM PEAK:** Sets the peak limit of the Data EVM.
 - **TEST LIMITS:** Enables or disables the test limit. Toggle this key between **On** and **Off**.
 - **HIGH LIMIT:** Sets the upper limit. Use the numeric keys to input value and press the unit soft key or the **ENTER** hard key to complete the input.
- Y **RS EVM:** *This key is not used in the Data Channel mode.*
- Y **P-SS EVM:** *This key is not used in the Data Channel mode.*
- Y **S-SS EVM:** *This key is not used in the Data Channel mode.*
- n **POWER:** *This key is not used in the Data Channel mode.*
- n **TIME ALIGNMENT ERROR:** *This key is not used in the Data Channel mode.*
- n **TIME ERROR:** *This key is not used in the Data Channel mode.*
- n **IQ ORIGIN OFFSET:** Sets the limit of I/Q origin offset.
- Y **TEST LIMIT:** Enables or disables the test limit. Toggle this soft key between **On** and **Off**.
- Y **HIGH LIMIT:** Sets the upper limit. Use the numeric keys to input value and press the unit soft key or the **ENTER** hard key to complete the input.

Measurement Example

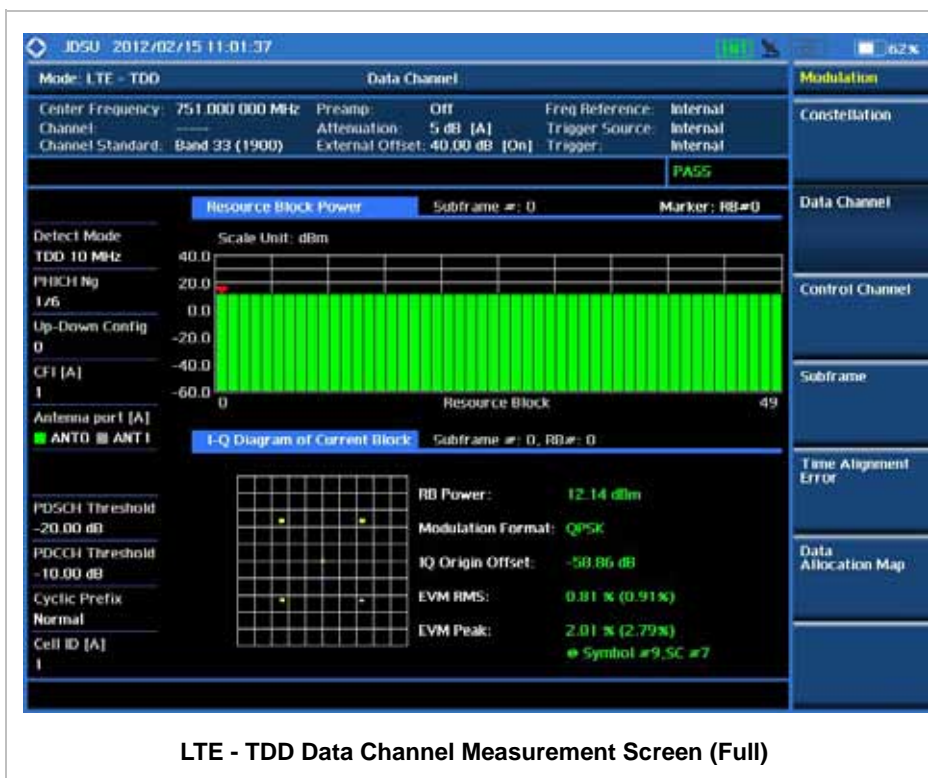

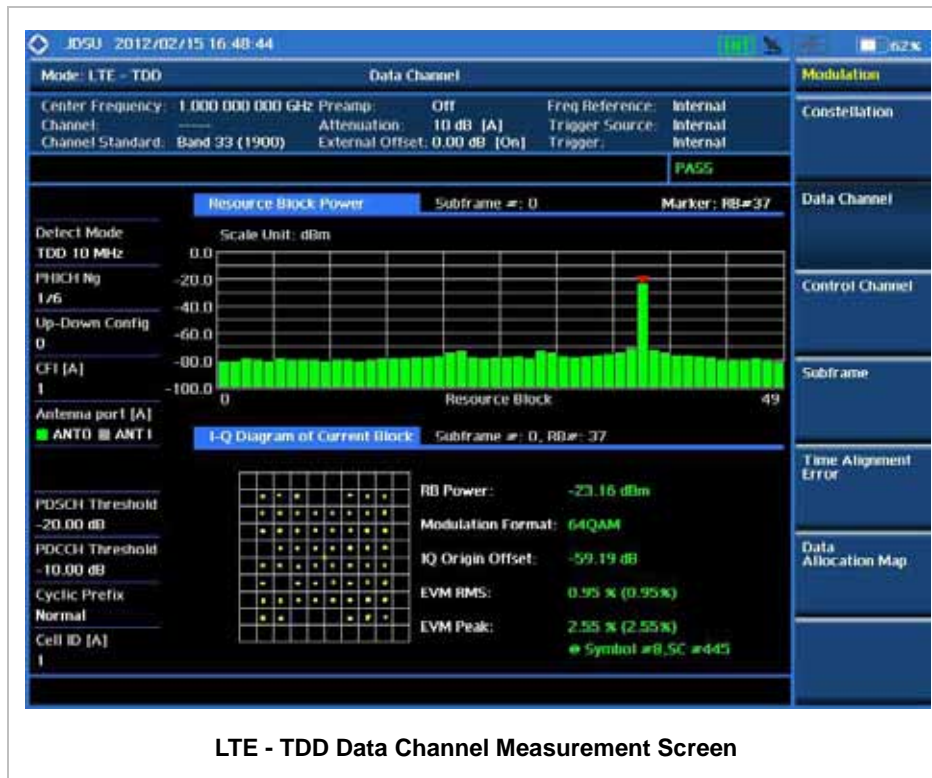

Using Marker

MARKER



- n **IQ DIAGRAM:** IQ Diagram operates based on the resource block designated by marker. Enable or disable the IQ diagram display on the screen by toggling this soft key between **On** and **Off**.
- n **RB NUMBER:** Sets the resource block (RB) number to be displayed. Press this soft key and use the rotary knob to move the resource block back and forth. Or use the numeric keys to enter a value and then press the **Enter** soft key to complete the input. Once the RB number is set after setting the IQ Diagram display option to On, IQ diagram shows details of the selected resource block.

CONTROL CHANNEL

Control Channel measures the constellation for the specified control channel as well as modulation accuracy of the control channel at the specified subframe.

Measurement Procedure

| Step | Description |
|---|--|
| 1. Set the measurement mode MEASURE [Modulation Analysis] [Control Channel] | Press the MEASURE hot key. Press the Modulation Analysis soft key. Press the Control Channel soft key. |
| 2. Set the measurement parameters MEASURE SETUP [Bandwidth] [1.4 MHz], [3 MHz], [5 MHz], [10 MHz], [15 MHz], or [20 MHz] [Subframe No] Enter a value [Enter] [PHICH Ng] [1/6], [1/2], [1], [2], [E-1/6], [E-1/2], [E-1], or [E-2] [CFI] <Auto> or <Manual> Enter a value [Enter] [Uplink-Downlink Configuration] [0], [1], [2], [3], [4], [5], or [6] [Cell ID] <Auto> or <Manual> Enter a value [Enter] | Press the MEASURE SETUP hot key. Press the Bandwidth soft key. Press one of the soft keys to select. Press the Subframe No soft key. Use the numeric keys to input value. Press the Enter soft key to complete the input. Press the PHICH Ng soft key. Select one of the soft keys to set the number of PHICH groups (Ng). Press the CFI soft key to toggle between Auto and Manual . Use the numeric keys to manually input value. Press the Enter soft key. Press the Uplink-Downlink Configuration soft key. Select one of the soft keys to choose. Press the Cell ID soft key. Toggle between Auto and Manual . Use the numeric keys to set the Cell ID manually. Press the Enter soft key. |

LTE - TDD Control Channel Measurement Procedure

MEASURE SETUP



- n **BANDWIDTH:** Selects the nominal channel bandwidth to be measured among **1.4 MHz, 3 MHz, 5 MHz, 10 MHz, 15 MHz, and 20 MHz.**
- n **SUBFRAME NO:** Sets the subframe number to be measured.
- n **CELL ID:** Enables or disables automatic detection of the Cell ID of the transmitted LTE signal. Manually setting the Cell ID to a specific one can speed up to get synchronization with BTS.
- Y **AUTO:** Detects the Cell ID automatically.

- Y **MANUAL:** Sets the Cell ID to a specific one.
- n **CFI:** Sets the number of OFDM symbols used for transmission of PDCCHs in a subframe. Toggle this soft key between **Auto** and **Manual**. The set of OFDM symbols that can be used for PDCCH in a subframe is given by **0, 2, 3** or **4** in 1.4 MHz bandwidth and **1, 2,** or **3** in other bandwidths.
- n **PHICH Ng:** Sets the number of PHICH groups (Ng) which is constant in all subframes. Choose the PHICH Ng among **1/6, 1/2, 1, 2, E-1/6, E-1/2, E-1,** or **E-2**.
- n **UPLINK-DOWNLINK CONFIGURATION:** Selects the number of uplink/downlink from 0 to 6.
- n **MISCELLANEOUS**
 - Y **ANTENNA PORT:** Sets the antenna port number automatically or manually. Each time this soft key is pressed, selection changes among **Auto, 0,** and **1**.
 - Y **DELAY:** Sets the delay in micro seconds. This key is used only when there is a time offset in the signals to be measured.
 - Y **CYCLIC PREFIX:** Sets the cyclic prefix to **Normal** or **Extended**. For OFDM parameter details by different bandwidth, refer to the table in the Appendix E – Cyclic Prefix Table.
 - Y **PDCCH THRESHOLD:** Sets the threshold of PDCCH.
 - Y **PDCCH MODE:** Sets the PDCCH mode among **REG** and **Avg**.
 - **REG:** Calculates EVM in accordance with REG (Resource Element Group) settings.
 - **AVG:** Calculates EVM after adding up all PDCCH signals from one subframe.

Setting Limit



This hot key is used to set the threshold value for the limit line on the display screen. It turns on or off the limit or band limit settings of the measurement for pass/fail indication. The user input window must be inactive first to get the Limit hot key function other than the number input.

| Step | Description |
|---|--|
| 1. Select the limit LIMIT [Modulation Test Limits] [Frequency Error] [Test Limits] <On> or <Off> [High Limit] [Low Limit] | Press the LIMIT hot key. Press the Modulation Test Limits soft key. Press the Frequency Error soft key. Press the Test Limits soft key. Toggle between On and Off . Use the numeric keys to input value. Use the numeric keys to input value. |

| | |
|--|---|
| <p>[EVM] [Data EVM RMS] [Test Limits] <On> or <Off> [High Limit]</p> <p>[Data EVM Peak] [Test Limits] <On> or <Off> [High Limit]</p> <p>[IQ Origin Offset] [Test Limit] <On> or <Off> [High Limit]</p> | <p>Press the EVM soft key.</p> <p>Press the Data EVM RMS soft key.</p> <p>Press the Test Limits soft key. Toggle between On and Off.</p> <p>Press the High Limit soft key to input value.</p> <p>Press the Data EVM Peak soft key.</p> <p>Press the Test Limits soft key. Toggle between On and Off.</p> <p>Press the High Limit soft key to input value.</p> <p>Press the IQ Origin Offset soft key.</p> <p>Press the Test Limit soft key. Toggle between On and Off.</p> <p>Use the numeric keys and input a number in dB.</p> |
| <p>2. Enable beep LIMIT [Beep] <On> or <Off></p> | <p>Press the LIMIT hot key.</p> <p>Press the Beep soft key to toggle between On and Off and select one. This will make audible alarm if the measurement result goes beyond the limit.</p> |

- n **FREQUENCY ERROR:** Sets the frequency error limit.
- Y **TEST LIMITS:** Enables or disables the test limits. Toggle this soft key between **On** and **Off**.
- Y **HIGH LIMIT:** Sets the upper limit. Use the numeric keys to input value and press the unit soft key or the **ENTER** hard key to complete the input.
- Y **LOW LIMIT:** Sets the lower limit. Use the numeric keys to input value and press the unit soft key or the **ENTER** hard key to complete the input.
- n **EVM:** Sets limits for Error Vector Magnitude.
 - Y **PDSCH EVM:** *This key is not used in the Control Channel mode.*
 - Y **DATA EVM RMS:** Sets the rms limit of the Data EVM.
 - **TEST LIMITS:** Enables or disables the test limit. Toggle this key between **On** and **Off**.
 - **HIGH LIMIT:** Sets the upper limit. Use the numeric keys to input value and press the unit soft key or the **ENTER** hard key to complete the input.
 - Y **DATA EVM PEAK:** Sets the peak limit of the Data EVM.
 - **TEST LIMITS:** Enables or disables the test limit. Toggle this key between **On** and **Off**.
 - **HIGH LIMIT:** Sets the upper limit. Use the numeric keys to input value and press the unit soft key or the **ENTER** hard key to complete the input.

- Y **RS EVM:** This key is not used in the Control Channel mode.
- Y **P-SS EVM:** This key is not used in the Control Channel mode.
- Y **S-SS EVM:** This key is not used in the Control Channel mode.
- n **POWER:** This key is not used in the Control Channel mode.
- n **TIME ALIGNMENT ERROR:** This key is not used in the Control Channel mode.
- n **TIME ERROR:** This key is not used in the Control Channel mode.
- n **IQ ORIGIN OFFSET:** Sets the limit of I/Q origin offset.
- Y **TEST LIMIT:** Enables or disables the test limit. Toggle this soft key between **On** and **Off**.
- Y **HIGH LIMIT:** Sets the upper limit. Use the numeric keys to input value and press the unit soft key or the **ENTER** hard key to complete the input.

Measurement Example

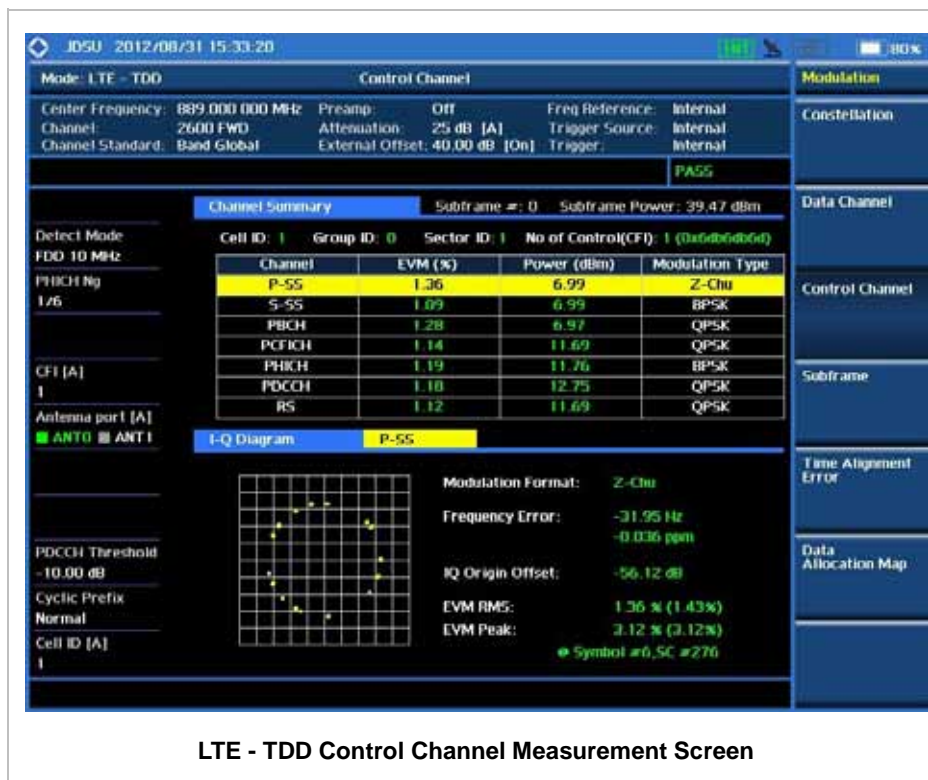

LTE - TDD Control Channel Measurement Screen

Using Marker

MARKER



- n **IQ DIAGRAM:** IQ Diagram operates based on the resource block designated by marker. Enable or disable the IQ diagram display on the screen by toggling this soft key between **On** and **Off**.

- n **CHANNEL:** Changes the channel to be displayed in the IQ Diagram on the display screen. The channel P-SS is set by default. Press this soft key and use the rotary knob or the arrow keys to change the channel to the others in the channel summary table. The IQ diagram shows details of the selected channel accordingly.

SUBFRAME

Subframe measures the modulation accuracy of all the data and control channels at the specified subframe (1 ms).

Measurement Procedure

| Step | Description |
|---|--|
| 1. Set the measurement mode MEASURE [Modulation Analysis] [Subframe] | Press the MEASURE hot key. Press the Modulation Analysis soft key. Press the Subframe soft key. |
| 2. Set the measurement parameters MEASURE SETUP [Bandwidth] [1.4 MHz], [3 MHz], [5 MHz], [10 MHz], [15 MHz], or [20 MHz] [Subframe No] Enter a value [Enter] [PHICH Ng] [1/6], [1/2], [1], [2], [E-1/6], [E-1/2], [E-1], or [E-2] [CFI] <Auto> or <Manual> Enter a value [Enter] [Uplink-Downlink Configuration] [0], [1], [2], [3], [4], [5], or [6] | Press the MEASURE SETUP hot key. Press the Bandwidth soft key. Press one of the soft keys to select. Press the Subframe No soft key. Use the numeric keys to input value. Press the Enter soft key to complete the input. Press the PHICH Ng soft key. Select one of the soft keys to set the number of PHICH groups (Ng). Press the CFI soft key to toggle between Auto and Manual . Use the numeric keys to manually input value. Press the Enter soft key. Press the Uplink-Downlink Configuration soft key. Select one of the soft keys to choose. |

| | |
|--|--|
| <p>[Cell ID]</p> <p><Auto> or <Manual></p> <p>Enter a value</p> <p>[Enter]</p> | <p>Press the Cell ID soft key. Toggle between Auto and Manual.</p> <p>Use the numeric keys to set the Cell ID manually.</p> <p>Press the Enter soft key.</p> |
|--|--|

LTE - TDD Subframe Measurement Procedure

MEASURE SETUP



- n **BANDWIDTH:** Selects the nominal channel bandwidth to be measured among **1.4 MHz, 3 MHz, 5 MHz, 10 MHz, 15 MHz, and 20 MHz**.
- n **SUBFRAME NO:** Sets the subframe number to be measured.
- n **CELL ID:** Enables or disables automatic detection of the Cell ID of the transmitted LTE signal. Manually setting the Cell ID to a specific one can speed up to get synchronization with BTS.
 - Y **AUTO:** Detects the Cell ID automatically.
 - Y **MANUAL:** Sets the Cell ID to a specific one.
- n **CFI:** Sets the number of OFDM symbols used for transmission of PDCCHs in a subframe. Toggle this soft key between **Auto** and **Manual**. The set of OFDM symbols that can be used for PDCCH in a subframe is given by **0, 2, 3 or 4** in 1.4 MHz bandwidth and **1, 2, or 3** in other bandwidths.
- n **PHICH Ng:** Sets the number of PHICH groups (Ng) which is constant in all subframes. Choose the PHICH Ng among **1/6, 1/2, 1, 2, E-1/6, E-1/2, E-1, or E-2**.
- n **UPLINK-DOWNLINK CONFIGURATION:** Selects the number of uplink/downlink from 0 to 6.
- n **MISCELLANEOUS**
 - Y **ANTENNA PORT:** Sets the antenna port number automatically or manually. Each time this soft key is pressed, selection changes among **Auto, 0, and 1**.
 - Y **DELAY:** Sets the delay in micro seconds. This key is used only when there is a time offset in the signals to be measured.
 - Y **CYCLIC PREFIX:** Sets the cyclic prefix to **Normal** or **Extended**. For OFDM parameter details by different bandwidth, refer to the table in the Appendix E – Cyclic Prefix Table.
 - Y **PDSCH MODULATION TYPE:** Sets the modulation type in a frame among **Auto, QPSK, 16QAM, 64QAM, E-TM3.3, E-TM3.2, E-TM3.1, E-TM2, E-TM1.2, and E-TM1.1**. If two or more modulation types are used in a frame, set the PDSCH Modulation Type to **Auto**. If the PDSCH uses the same modulation type in a frame or in a subframe, set it to specific modulation type to get more accurate EVM.
 - Y **PDSCH THRESHOLD:** Sets the threshold of PDSCH. Use the numeric keys to input value and press the **dB** unit soft key to complete the input.

- Y **PDCCH THRESHOLD:** Sets the threshold of PDCCH.
- Y **PDCCH MODE:** Sets the PDCCH mode among **REG** and **Avg**.
 - **REG:** Calculates EVM in accordance with REG (Resource Element Group) settings.
 - **AVG:** Calculates EVM after adding up all PDCCH signals from one subframe.

Setting Limit



This hot key is used to set the threshold value for the limit line on the display screen. It turns on or off the limit or band limit settings of the measurement for pass/fail indication. The user input window must be inactive first to get the Limit hot key function other than the number input.

| Step | Description |
|--|---|
| 1. Select the limit LIMIT [Modulation Test Limits] [Frequency Error] [Test Limits] <On> or <Off> [High Limit] [Low Limit] [EVM] [Data EVM RMS] [Test Limits] <On> or <Off> [High Limit] [Data EVM Peak] [Test Limits] <On> or <Off> [High Limit] [RS EVM] [Test Limits] <On> or <Off> [High Limit] [Power] | Press the LIMIT hot key. Press the Modulation Test Limits soft key. Press the Frequency Error soft key. Press the Test Limits soft key. Toggle between On and Off . Use the numeric keys to input value. Use the numeric keys to input value. Press the EVM soft key. Press the Data EVM RMS soft key. Press the Test Limits soft key. Toggle between On and Off . Press the High Limit soft key to input value. Press the Data EVM Peak soft key. Press the Test Limits soft key. Toggle between On and Off . Press the High Limit soft key to input value. Press the RS EVM soft key. Press the Test Limits soft key. Toggle between On and Off . Use the numeric keys and input. Press the Power soft key. |

| | |
|--|--|
| <p>[DL RS Power] [Test Limits] <On> or <Off> [High Limit] [Low Limit]</p> <p>[P-SS Power] [Test Limits] <On> or <Off> [High Limit] [Low Limit]</p> <p>[S-SS Power] [Test Limits] <On> or <Off> [High Limit] [Low Limit]</p> <p>[PBCH Power] [Test Limits] <On> or <Off> [High Limit] [Low Limit]</p> <p>[Subframe Power] [Test Limits] <On> or <Off> [High Limit] [Low Limit]</p> <p>[OFDM Symbol Power] [Test Limits] <On> or <Off> [High Limit] [Low Limit]</p> <p>[Time Error] [Test Limits] <On> or <Off> [High Limit] [Low Limit]</p> | <p>Press the DL RS Power soft key. Press the Test Limits soft key. Toggle between On and Off. Use the numeric keys and input. Use the numeric keys and input.</p> <p>Press the P-SS Power soft key. Press the Test Limit soft key. Toggle between On and Off. Use the numeric keys and input. Use the numeric keys and input.</p> <p>Press the S-SS Power soft key. Press the Test Limit soft key. Toggle between On and Off. Use the numeric keys and input. Use the numeric keys and input.</p> <p>Press the PBCH Power soft key. Press the Test Limit soft key. Toggle between On and Off. Use the numeric keys and input. Use the numeric keys and input.</p> <p>Press the Subframe Power soft key. Press the Test Limit soft key. Toggle between On and Off. Use the numeric keys and input. Use the numeric keys and input.</p> <p>Press the OFDM Symbol Power soft key. Press the Test Limit soft key. Toggle between On and Off. Use the numeric keys and input. Use the numeric keys and input.</p> <p>Press the Time Error soft key. Press the Test Limits soft key. Toggle between On and Off. Use the numeric keys to input value. Use the numeric keys to input value.</p> |
| <p>2. Enable beep LIMIT [Beep]</p> | <p>Press the LIMIT hot key. Press the Beep soft key to toggle between On and Off</p> |

| | |
|----------------------------------|---|
| <On> or <Off> | and select one. This will make audible alarm if the measurement result goes beyond the limit. |
|----------------------------------|---|

- n **FREQUENCY ERROR:** Sets the frequency error limit.
- Y **TEST LIMITS:** Enables or disables the test limits. Toggle the **Test Limits** soft key between **On** and **Off**.
- Y **HIGH LIMIT:** Sets the upper limit. Use the numeric keys to input value and press the unit soft key or the **ENTER** hard key to complete the input.
- Y **LOW LIMIT:** Sets the lower limit. Use the numeric keys to input value and press the unit soft key or the **ENTER** hard key to complete the input.
- n **EVM:** Sets limits for Error Vector Magnitude.
 - Y **PDSCH EVM:** *This key is not used in the Subframe mode.*
 - Y **DATA EVM RMS:** Sets the rms limit of the Data EVM.
 - **TEST LIMITS:** Enables or disables the test limit. Toggle this soft key between **On** and **Off**.
 - **HIGH LIMIT:** Sets the upper limit. Use the numeric keys to input value and press the unit soft key or the **ENTER** hard key to complete the input.
 - Y **DATA EVM PEAK:** Sets the peak limit of the Data EVM.
 - **TEST LIMITS:** Enables or disables the test limit. Toggle this soft key between **On** and **Off**.
 - **HIGH LIMIT:** Sets the upper limit. Use the numeric keys to input value and press the unit soft key or the **ENTER** hard key to complete the input.
 - Y **RS EVM:** Sets the RS EVM.
 - **TEST LIMITS:** Enables or disables the test limits. Toggle this soft key between **On** and **Off**.
 - **HIGH LIMIT:** Sets the upper limit. Use the numeric keys to input value and press the unit soft key or the **ENTER** hard key to complete the input.
 - Y **P-SS EVM:** *This key is not used in the Subframe mode.*
 - Y **S-SS EVM:** *This key is not used in the Subframe mode.*
- n **POWER:** Set power limits.
 - Y **DL RS POWER:** Sets the Downlink RS power limit.
 - **TEST LIMITS:** Enables or disables the test limits. Toggle this soft key between **On** and **Off**.

- **HIGH LIMIT:** Sets the upper limit. Use the numeric keys to input value and press the unit soft key or the **ENTER** hard key to complete the input.
 - **LOW LIMIT:** Sets the lower limit. Use the numeric keys to input value and press the unit soft key or the **ENTER** hard key to complete the input.
- Y **P-SS POWER:** Sets the P-SS power limit.
- **TEST LIMITS:** Enables or disables the test limits. Toggle this soft key between **On** and **Off**.
 - **HIGH LIMIT:** Sets the upper limit. Use the numeric keys to input value and press the unit soft key or the **ENTER** hard key to complete the input.
 - **LOW LIMIT:** Sets the lower limit. Use the numeric keys to input value and press the unit soft key or the **ENTER** hard key to complete the input.
- Y **S-SS POWER:** Sets the S-SS power limit.
- **TEST LIMITS:** Enables or disables the test limits. Toggle this soft key between **On** and **Off**.
 - **HIGH LIMIT:** Sets the upper limit. Use the numeric keys to input value and press the unit soft key or the **ENTER** hard key to complete the input.
 - **LOW LIMIT:** Sets the lower limit. Use the numeric keys to input value and press the unit soft key or the **ENTER** hard key to complete the input.
- Y **PBCH POWER:** Sets the PBCH power limit.
- **TEST LIMITS:** Enables or disables the test limits. Toggle this soft key between **On** and **Off**.
 - **HIGH LIMIT:** Sets the upper limit. Use the numeric keys to input value and press the unit soft key or the **ENTER** hard key to complete the input.
 - **LOW LIMIT:** Sets the lower limit. Use the numeric keys to input value and press the unit soft key or the **ENTER** hard key to complete the input.
- Y **SUBFRAME POWER:** Sets the subframe power limit.
- **TEST LIMITS:** Enables or disables the test limits. Toggle this soft key between **On** and **Off**.
 - **HIGH LIMIT:** Sets the upper limit. Use the numeric keys to input value and press the unit soft key or the **ENTER** hard key to complete the input.
 - **LOW LIMIT:** Sets the lower limit. Use the numeric keys to input value and press the unit soft key or the **ENTER** hard key to complete the input.
- Y **OFDM SYMBOL POWER:** Sets the OFDM symbol power limit.

- **TEST LIMITS:** Enables or disables the test limits. Toggle this soft key between **On** and **Off**.
 - **HIGH LIMIT:** Sets the upper limit. Use the numeric keys to input value and press the unit soft key or the **ENTER** hard key to complete the input.
 - **LOW LIMIT:** Sets the lower limit. Use the numeric keys to input value and press the unit soft key or the **ENTER** hard key to complete the input.
- n **TIME ALIGNMENT ERROR:** *This key is not used in the Subframe mode.*
- n **TIME ERROR:** Sets the limit of the Time Error.
- Y **TEST LIMITS:** Enables or disables the test limits. Toggle this soft key between **On** and **Off**.
- Y **HIGH LIMIT:** Sets the upper limit. Use the numeric keys to input value and press the unit soft key or the **ENTER** hard key to complete the input.
- Y **LOW LIMIT:** Sets the lower limit. Use the numeric keys to input value and press the unit soft key or the **ENTER** hard key to complete the input.
- n **IQ ORIGIN OFFSET:** *This key is not used in the Subframe mode.*

Setting Display

TRACE/DISPLAY



- n **CHART:** Turns the chart on the display screen on or off. Toggle between **On** and **Off**. When this function is turned on, the measurement screen will be changed to Chart view and the Marker hard key function will be activated.

Measurement Example

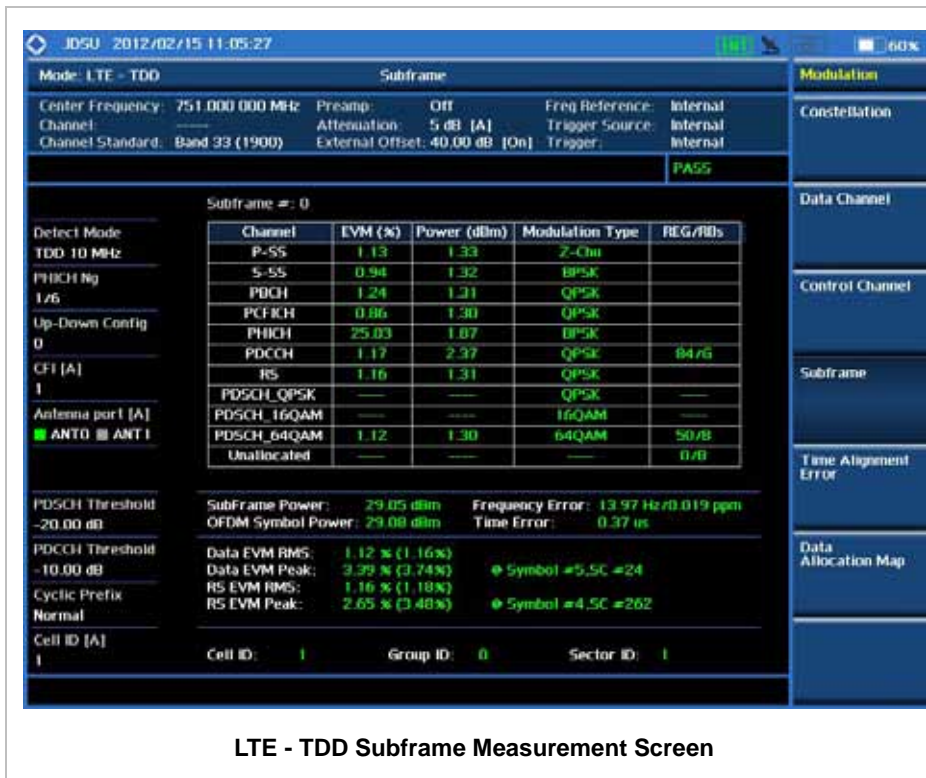

LTE - TDD Subframe Measurement Screen

The following example shows the display screen when the **Chart** soft menu is set to **On** in Trace/Display hard key function.

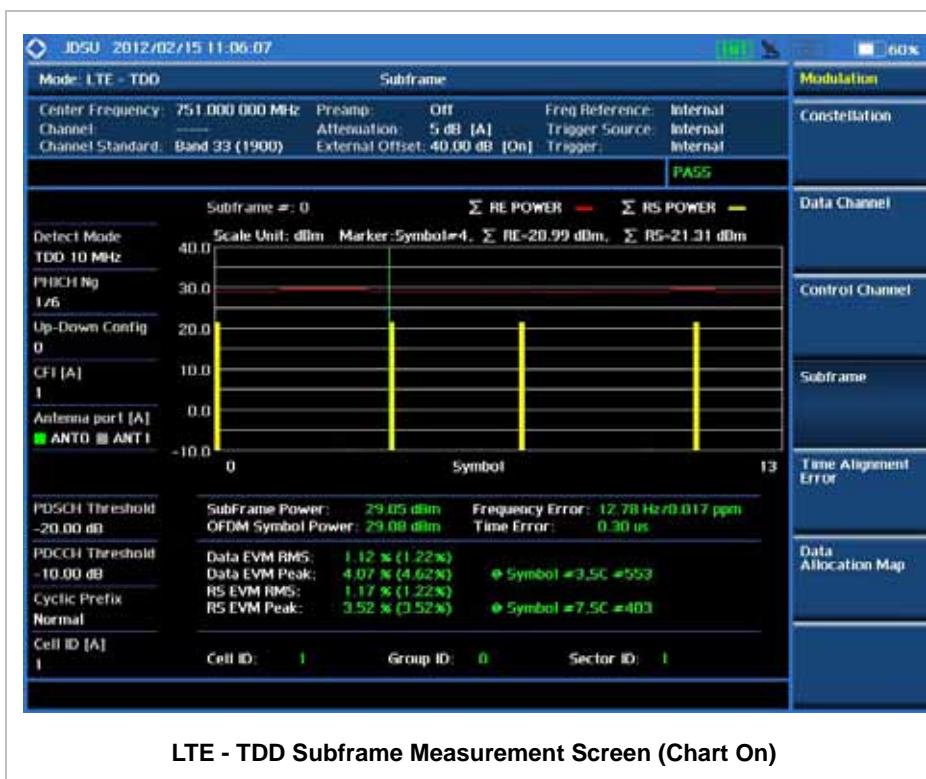

LTE - TDD Subframe Measurement Screen (Chart On)

Using Marker



- n **MARKER VIEW:** IQ Diagram operates based on the resource block designated by marker. Enable or disable the IQ diagram display on the screen by toggling this soft key between **On** and **Off**.
- n **NORMAL:** This Normal marker type provides the reading of a marker position on the trace along with the marker number between 1 and 6.

TIME ALIGNMENT ERROR

In eNode B supporting Tx Diversity transmission, signals are transmitted from two or more antennas. These signals shall be aligned. The time alignment error in Tx Diversity is specified as the delay between the signals from two antennas at the antenna ports.

Measurement Procedure

| Step | Description |
|--|--|
| 1. Set the measurement mode MEASURE [Modulation Analysis] [Time Alignment Error] | Press the MEASURE hot key. Press the Modulation Analysis soft key. Press the Time Alignment Error soft key. |
| 2. Set the measurement parameters MEASURE SETUP [Bandwidth] [1.4 MHz], [3 MHz], [5 MHz], [10 MHz], [15 MHz], or [20 MHz] [Cell ID] <Auto> or <Manual> Enter a value [Enter] | Press the MEASURE SETUP hot key. Press the Bandwidth soft key. Press one of the soft keys to select. Press the Cell ID soft key. Toggle between Auto and Manual . Use the numeric keys to set the Cell ID manually. Press the Enter soft key. |

LTE - TDD Time Alignment Error Measurement Procedure



- n **BANDWIDTH:** Selects the nominal channel bandwidth to be measured among **1.4 MHz, 3 MHz, 5 MHz, 10 MHz, 15 MHz,** and **20 MHz.**
- n **CELL ID:** Enables or disables automatic detection of the Cell ID of the transmitted LTE signal. Manually setting the Cell ID to a specific one can speed up to get synchronization with BTS.
 - Y **AUTO:** Detects the Cell ID automatically.
 - Y **MANUAL:** Sets the Cell ID to a specific one.
- n **MISCELLANEOUS**
 - Y **DELAY:** Sets the delay in micro seconds. This key is used only when there is a time offset in the signals to be measured.
 - Y **CYCLIC PREFIX:** Sets the cyclic prefix to **Normal** or **Extended.** For OFDM parameter details by different bandwidth, refer to the table in the Appendix E – Cyclic Prefix Table.

Setting Limit



This hot key is used to set the threshold value for the limit line on the display screen. It turns on or off the limit or band limit settings of the measurement for pass/fail indication. The user input window must be inactive first to get the Limit hot key function other than the number input.

| Step | Description |
|---|---|
| 1. Select the limit LIMIT [Modulation Test Limits] [Time Alignment Error] [Test Limits] <On> or <Off> [High Limit] [EVM] [RS EVM] [Test Limits] <On> or <Off> [High Limit] [Power] [DL RS Power] [Test Limits] <On> or <Off> | Press the LIMIT hot key. Press the Modulation Test Limits soft key. Press the Time Alignment Error soft key. Press the Test Limits soft key. Toggle between On and Off . Use the numeric keys to input value. Press the EVM soft key. Press the RS EVM soft key. Press the Test Limits soft key. Toggle between On and Off . Use the numeric keys and input. Press the Power soft key. Press the DL RS Power soft key. Press the Test Limits soft key. Toggle between On and Off . |

| | |
|---|--|
| <p>[High Limit] [Low Limit]</p> | <p>Use the numeric keys and input. Use the numeric keys and input.</p> |
| <p>2. Enable beep LIMIT [Beep] <On> or <Off></p> | <p>Press the LIMIT hot key. Press the Beep soft key to toggle between On and Off and select one. This will make audible alarm if the measurement result goes beyond the limit.</p> |

- n **FREQUENCY ERROR:** *This key is not used in the Time Alignment Error mode.*
- n **EVM:** Sets limits for Error Vector Magnitude.
 - Y **PDSCH EVM:** *This key is not used in the Time Alignment Error mode.*
 - Y **DATA EVM RMS:** *This key is not used in the Time Alignment Error mode.*
 - Y **DATA EVM PEAK:** *This key is not used in the Time Alignment Error mode.*
 - Y **RS EVM:** Sets the RS EVM.
 - **TEST LIMITS:** Enables or disables the test limits. Toggle this key between **On** and **Off**.
 - **HIGH LIMIT:** Sets the upper limit. Use the numeric keys to input value and press the unit soft key or the **ENTER** hard key to complete the input.
 - Y **P-SS EVM:** *This key is not used in the Time Alignment Error mode.*
 - Y **S-SS EVM:** *This key is not used in the Time Alignment Error mode.*
- n **POWER:** Set power limits.
 - Y **DL RS POWER:** Sets the Downlink RS power limit.
 - **TEST LIMITS:** Enables or disables the test limits. Toggle this key between **On** and **Off**.
 - **HIGH LIMIT:** Sets the upper limit. Use the numeric keys to input value and press the unit soft key or the **ENTER** hard key to complete the input.
 - **LOW LIMIT:** Sets the lower limit. Use the numeric keys to input value and press the unit soft key or the **ENTER** hard key to complete the input.
 - Y **P-SS POWER:** *This key is not used in the Time Alignment Error mode.*
 - Y **S-SS POWER:** *This key is not used in the Time Alignment Error mode.*
 - Y **PBCH POWER:** *This key is not used in the Time Alignment Error mode.*
 - Y **SUBFRAME POWER:** *This key is not used in the Time Alignment Error mode.*
 - Y **OFDM SYMBOL POWER:** *This key is not used in the Time Alignment Error mode.*
- n **TIME ALIGNMENT ERROR:** Sets the limit of time alignment error.
 - Y **TEST LIMIT:** Enables or disables the test limit. Toggle this soft key between **On** and **Off**.

- Y **HIGH LIMIT:** Sets the upper limit. Use the numeric keys to input value and press the unit soft key or the **ENTER** hard key to complete the input.
- n **TIME ERROR:** This key is not used in the Time Alignment Error mode.
- n **IQ ORIGIN OFFSET:** This key is not used in the Time Alignment Error mode.

Measurement Example

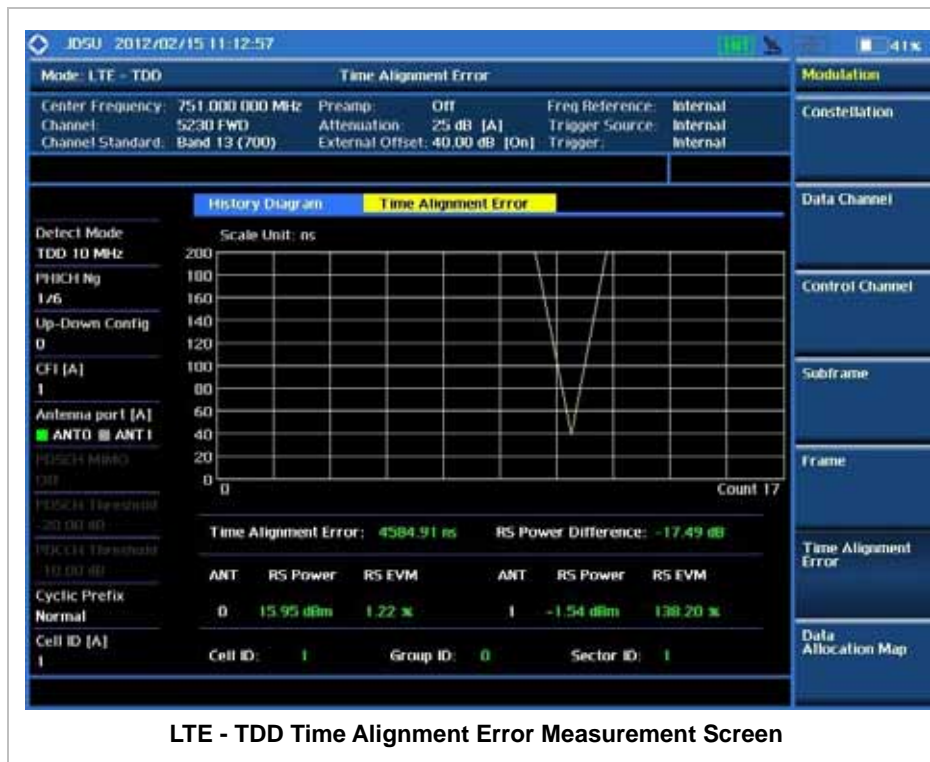

DATA ALLOCATION MAP

The Data Allocation Map function represents data allocation as a mapping.

Measurement Procedure

| Step | Description |
|---|---|
| 1. Set the measurement mode MEASURE [Modulation Analysis] [Data Allocation Map] | Press the MEASURE hot key. Press the Modulation Analysis soft key. Press the Data Allocation Map soft key. |

| | |
|---|---|
| <p>2. Set the measurement parameters</p> <p>MEASURE SETUP</p> <p>[Bandwidth] [1.4 MHz], [3 MHz], [5 MHz], [10 MHz], [15 MHz], or [20 MHz]</p> <p>[Subframe No] Enter a value [Enter]</p> <p>[PDSCH Threshold] Enter a value [dB] or ENTER</p> <p>[Cell ID] <Auto> or <Manual> Enter a value [Enter]</p> | <p>Press the MEASURE SETUP hot key.</p> <p>Press the Bandwidth soft key.</p> <p>Press one of the soft keys to select.</p> <p>Press the Subframe No soft key.</p> <p>Use the numeric keys to input value.</p> <p>Press the Enter soft key to complete the input.</p> <p>Press the PDSCH Threshold soft key.</p> <p>Use the numeric keys to input value.</p> <p>Press the unit soft key or the ENTER hard key to complete the input.</p> <p>Press the Cell ID soft key. Toggle between Auto and Manual.</p> <p>Use the numeric keys to set the Cell ID manually.</p> <p>Press the Enter soft key.</p> |
|---|---|

LTE - TDD Data Allocation Map Measurement Procedure

MEASURE SETUP



- n **BANDWIDTH:** Selects the nominal channel bandwidth to be measured among **1.4 MHz, 3 MHz, 5 MHz, 10 MHz, 15 MHz,** and **20 MHz.**
- n **SUBFRAME NO:** Sets the subframe number to be measured.
- n **PDSCH THRESHOLD:** Sets the PDSCH threshold.
- n **CELL ID:** Enables or disables automatic detection of the Cell ID of the transmitted LTE signal. Manually setting the Cell ID to a specific one can speed up to get synchronization with BTS.
 - Y **AUTO:** Detects the Cell ID automatically.
 - Y **MANUAL:** Sets the Cell ID to a specific one.
- n **MISCELLANEOUS**
 - Y **ANTENNA PORT:** Sets the antenna port number automatically or manually. Each time this soft key is pressed, selection changes among **Auto, 0,** and **1.**
 - Y **CYCLIC PREFIX:** Sets the cyclic prefix to **Normal** or **Extended.** For OFDM parameter details by different bandwidth, refer to the table in the Appendix E – Cyclic Prefix Table.

Measurement Example

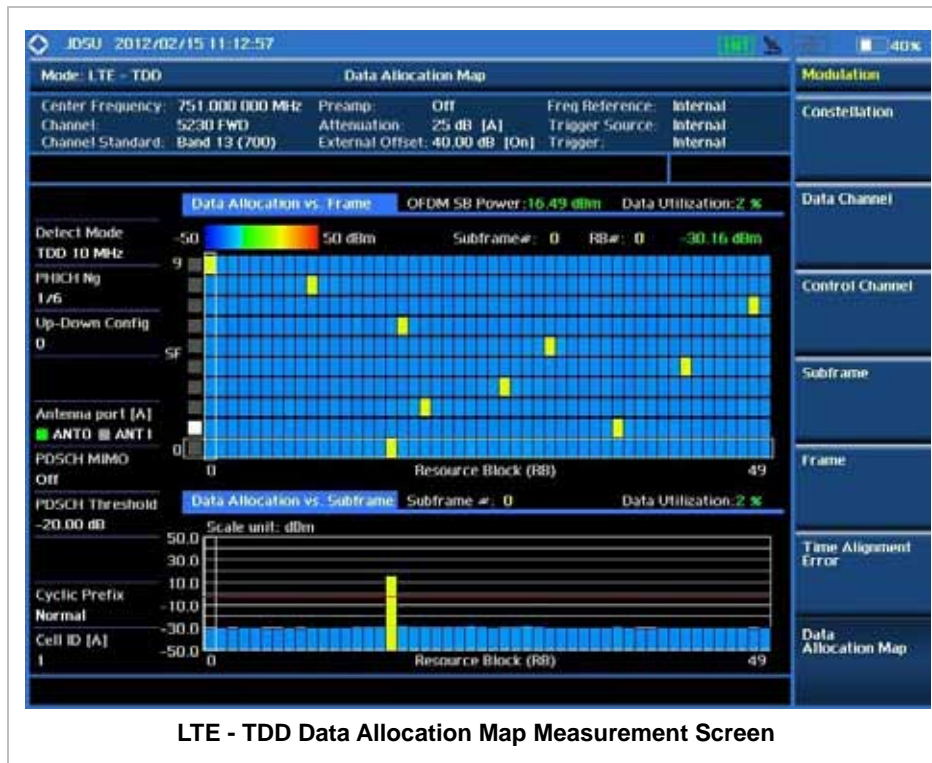

Using Marker

MARKER



- n **MARKER VIEW:** IQ Diagram operates based on the resource block designated by marker. Enable or disable the IQ diagram display on the screen by toggling this soft key between **On** and **Off**.
- n **RB NUMBER:** Sets the resource block (RB) number to be displayed. Press this soft key and use the rotary knob to move the resource block back and forth. Or use the numeric keys to enter a value and then press the **Enter** soft key to complete the input.
- n **SUBFRAME NO:** Sets the subframe number to be displayed. Press this soft key and use the rotary knob to move the selected subframe up and down. Or use the numeric keys to enter a value and then press the **Enter** soft key to complete the input.

AUTO MEASUREMENTS

The Auto Measure function of the JD740A series allows a complete signal profiling covering RF characterization and modulation quality parameters of up to 20 different carriers, particularly useful on an overlay architecture where base stations are transmitting in different frequencies.

The Auto Measure in LTE - TDD Signal Analyzer provides single-button measurements for the following measurements.

- n Conformance Test
- n Maintenance Test
- n Signal Performance Test

Setting Mode

| Step | Description |
|--|--|
| 1. Connect the cable | Connect a cable directly or indirectly as shown in the section Connecting a Cable on page 8 of this chapter. |
| 2. Select the mode MODE [Signal Analyzer] [LTE - TDD] [Auto Measure] [Conformance Test], [Maintenance Test], or [Signal Performance] | Press the MODE hard key. Press the Signal Analyzer soft key. Press the LTE - TDD soft key. Press the Auto Measure soft key. Press one of the measurement mode soft keys to select. |

Setting Trigger Source



This hot key is used to select the trigger source among **Internal**, **External**, and **GPS**. The user input window must be inactive first to get the Trigger hot key function other than the number input.

Setting External Clock

To enhance the reliability of modulation analysis measurements the JD740A series must be synchronized with the Base Station. When an external clock is not supplied, the JD740A series works with a built-in internal high-accuracy time base. In this case, some measurement results may exhibit inaccurate values. Therefore, it is highly recommended to use the same reference clock as signal source. Trigger mode can be changed by using the **TRIGGER** hot key.

EXTERNAL CLOCK OPERATING STANDARDS

| Clock | Type | Reference | Port | Switching Standard |
|--------------------|----------|--------------------|---------------|--|
| External Reference | Internal | Internal 10 MHz | | Default |
| | External | External Ref Clock | Ext Ref (SMA) | Manual switching (Input signal level >-3 dBm) |
| | GPS | GPS Clock | GPS (SMA) | Automatic switching (GPS signal received) |
| Trigger | Internal | Internal Trigger | | Default |
| | External | External Trigger | Trigger (SMA) | Manual switching |
| | GPS | GPS | GPS (SMA) | Manual switching |

CONNECTION

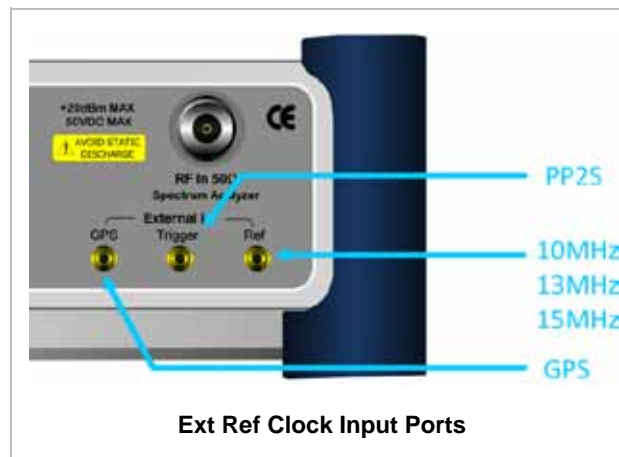

ENABLING EXTERNAL REFERENCE

| Step | Description |
|--|--|
| 1. Connect an external reference | Connect one of the external references or a GPS antenna to the JD740A series. |
| 2. Change reference clock SYSTEM [Frequency Reference] [External 10 MHz], [External 13 MHz], [External 15 MHz] or [GPS] | Press the SYSTEM hot key. Press the Frequency Reference soft key to select one of the external reference clocks or GPS. Press one of the soft keys to choose among External 10 MHz , External 13 MHz , External 15 MHz , and GPS . |

EXTERNAL REFERENCE INDICATOR INFORMATION

Each indicator tells different locking status according to a connection. When a GPS antenna is connected, longitude and latitude information will be displayed on the screen.

| Type | Indicator | Description |
|----------|--|----------------------------------|
| Internal |  (Green) | Locked |
| External |  (Green) | Locked |
| |  (Red) | Unlocked |
| GPS |  (Green) | Locked |
| |  (Yellow) | Locking in progress |
| |  (Gray) | Unable to lock or antenna failed |

CONFORMANCE TEST

The Conformance Test is to test if eNode-B meets some specified standards that have been developed for verification. Its test procedure and test setups have been developed by 3GPP. Test results can be saved as a *.csv file format.

Setting Limit



This hot key is used to set the threshold value for the limit line on the display screen. It turns on or off the limit or band limit settings of the measurement for pass/fail indication. The user input window must be inactive first to get the Limit hot key function other than the number input.

Each of the test items can be determined whether it will be tested or not in this Limit menu.

| Step | Description |
|---|---|
| 1. Set the test limit LIMIT [BTS Output Power] [Test Limits] <On> or <Off> [High Limit] Enter a value | Press the LIMIT hot key. Press the BTS Output Power soft key. Press the Test Limits soft key to toggle between On and Off and select one. Press the High Limit soft key to set the upper limit of the Pass/Fail criteria. Use the numeric keys to input value. |

| | |
|------------------------|---|
| [dBm] or ENTER | Press the unit soft key or the ENTER hard key. |
| [Low Limit] | Press the Low Limit soft key to set the lower limit of the |
| Enter a value | Pass/Fail criteria. Use the numeric keys to input value. |
| [dBm] or ENTER | Press the unit soft key or the ENTER hard key. |
| [Total Power Dynamic] | Press the Total Power Dynamic soft key. |
| [Test Limits] | Press the Test Limits soft key to toggle between On and |
| <On> or <Off> | Off and select one. |
| [Low Limit] | Press the Low Limit soft key to set the lower limit of the |
| Enter a value | Pass/Fail criteria. Use the numeric keys to input value. |
| [dB] or ENTER | Press the unit soft key or the ENTER hard key. |
| [On/Off Power] | Press the On/Off Power soft key. |
| [Off Power] | Press the Off Power soft key. |
| [Test Limits] | Press the Test Limits soft key. Toggle between On and |
| <On> or <Off> | Off . |
| [High Limit] | Press the High Limit soft key to input value. |
| [Transition Period] | Press the Transition Period soft key. |
| [Test Limits] | Press the Test Limits soft key. Toggle between On and |
| <On> or <Off> | Off . |
| [High Limit] | Press the High Limit soft key to input value. |
| [Signal Quality] | Press the Signal Quality soft key. |
| [Frequency Error] | Press the Frequency Error soft key. |
| [Test Limits] | Press the Test Limits soft key. Toggle between On and |
| <On> or <Off> | Off . |
| [High Limit] | Use the numeric keys to input value. |
| [Low Limit] | Use the numeric keys to input value. |
| [EVM] | Press the EVM soft key. |
| [Test Limits] | Press the Test Limits soft key. Toggle between On and |
| <On> or <Off> | Off . |
| [High Limit (QPSK)] | Press the High Limit soft key to input value. |
| [High Limit (16QAM)] | |
| [High Limit (64QAM)] | |
| [Time Alignment Error] | Press the Time Alignment Error soft key. |
| [Test Limits] | Press the Test Limits soft key. Toggle between On and |
| <On> or <Off> | Off . |
| [High Limit] | Use the numeric keys to input value. |
| [RS Power] | Press the RS Power soft key. |
| [Test Limits] | Press the Test Limits soft key. Toggle between On and |

| | |
|---|---|
| <p><On> or <Off> [High Limit] [Low Limit]</p> | <p>Off. Use the numeric keys and input. Use the numeric keys and input.</p> |
| <p>[Unwanted Emissions] [Occupied BW] [Test Limit] <On> or <Off> [High Limit] Enter a value [MHz], [kHz], or [Hz]</p> | <p>Press the Unwanted Emissions soft key. Press the Occupied BW soft key. Press the Test Limit soft key to toggle between On and Off and select one. Press the High Limit soft key to set the upper limit of the Pass/Fail criteria. Use the numeric keys to input value. Press the unit soft key to select.</p> |
| <p>[ACLR] [Test Limit] <On> or <Off></p> | <p>Press the ACLR soft key. Press the Test Limit soft key to toggle between On and Off and select one.</p> |
| <p>[Spectrum Emission Mask] [Test Limit] <On> or <Off> [Mask Type] [Wide Area BS Category A], [Wide Area BS Category B], [Local Area BS], or [Home BS]</p> | <p>Press the Spectrum Emission Mask soft key. Press the Test Limit soft key to toggle between On and Off and select one. Press the Mask Type soft key. Press one of the soft keys to select.</p> |
| <p>[Spurious Emissions] [Test Limit] <On> or <Off> [Range Table] [Range] Enter a value [Enter] [Start Frequency] Enter a value [GHz], [MHz], [kHz], or [Hz] [Stop Frequency] Enter a value [GHz], [MHz], [kHz], or [Hz] [Start Limit] Enter a value [dBm] [Stop Limit] Enter a value [dBm]</p> | <p>Press the Spurious Emissions soft key. Press the Test Limit soft key to toggle between On and Off and select one. Press the Range Table soft key. Press the Range soft key. Use the numeric keys to select the range number. Press the Enter soft key. Press the Start Frequency soft key. Use the numeric keys. Press one of the unit soft keys to select. Press the Stop Frequency soft key. Use the numeric keys. Press one of the unit soft keys to select. Press the Start Limit soft key. Use the numeric keys. Press the unit soft key to complete the input. Press the Stop Limit soft key. Use the numeric keys. Press the unit soft key to complete the input.</p> |

| | |
|--|---|
| <p>[Attenuation] Enter a value</p> <p>[dB] or ENTER</p> <p>[RBW] Enter a value</p> <p>[GHz], [MHz], [kHz], or [Hz]</p> <p>[VBW] Enter a value</p> <p>[GHz], [MHz], [kHz], or [Hz]</p> | <p>Press the Attenuation soft key.</p> <p>Use the numeric keys to enter input value in the multiple of 5.</p> <p>Press the dB unit soft key or the ENTER hard key.</p> <p>Press the RBW soft key.</p> <p>Use the numeric keys.</p> <p>Press one of the unit soft keys to select.</p> <p>Press the VBW soft key.</p> <p>Use the numeric keys.</p> <p>Press one of the unit soft keys to select.</p> |
| <p>2. Enable beep</p> <p>LIMIT</p> <p>[Beep]</p> <p><On> or <Off></p> | <p>Press the LIMIT hot key.</p> <p>Press the Beep soft key to toggle between On and Off and select one. This will make audible alarm if the measurement result goes beyond the limit.</p> |

- n **BTS OUTPUT POWER:** Sets the BTS output power test limit parameters.
 - Y **TEST LIMITS:** Enables or disables Pass/Fail results on the display screen. Toggle the **Test Limits** soft key to set it to **On** or **Off**.
 - Y **HIGH LIMIT:** Sets the upper limit of the Pass/Fail criteria. Use the numeric keys to enter a threshold or limit value and press the **dBm** unit soft key or the **ENTER** hard key to complete the input.
 - Y **LOW LIMIT:** Sets the lower limit of the Pass/Fail criteria. Use the numeric keys to enter a threshold or limit value and press the **dBm** unit soft key or the **ENTER** hard key to complete the input.
- n **TOTAL POWER DYNAMIC:** Sets the total power dynamic test limit parameters.
 - Y **TEST LIMITS:** Enables or disables Pass/Fail results on the display screen. Toggle the **Test Limits** soft key to set it to **On** or **Off**.
 - Y **LOW LIMIT:** Sets the lower limit of the Pass/Fail criteria. Use the numeric keys to enter a threshold or limit value and press the **dB** unit soft key or the **ENTER** hard key to complete the input.
- n **ON/OFF POWER**
 - Y **OFF POWER:** Sets the off power limit.
 - **TEST LIMITS:** Enables or disables the test limit. Toggle this soft key between **On** and **Off**.
 - **HIGH LIMIT:** Sets the upper limit of the off power. Use the numeric keys to input value and press the unit soft key or the **ENTER** hard key to complete the input.

- Y **TRANSITION PERIOD:** Sets the transition period limit.
 - **TEST LIMITS:** Enables or disables the test limit. Toggle this soft key between **On** and **Off**.
 - **HIGH LIMIT:** Sets the upper limit of the transition period. Use the numeric keys to input value and press the unit soft key or the **ENTER** hard key to complete the input.
- n **SIGNAL QUALITY:** Sets the test limit parameters to verify signal quality.
- Y **FREQUENCY ERROR:** Sets the frequency error limit.
 - **TEST LIMITS:** Enables or disables the test limits. Toggle this soft key between **On** and **Off**.
 - **HIGH LIMIT:** Sets the upper limit. Use the numeric keys to input value and press the unit soft key or the **ENTER** hard key to complete the input.
 - **LOW LIMIT:** Sets the lower limit. Use the numeric keys to input value and press the unit soft key or the **ENTER** hard key to complete the input.
- Y **EVM:** Sets the Error Vector Magnitude limit.
 - **TEST LIMITS:** Enables or disables the test limit. Toggle this soft key between **On** and **Off**.
 - **HIGH LIMIT (QPSK):** Sets the upper limit of QPSK. Use the numeric keys to input value and press the unit soft key or the **ENTER** hard key to complete the input.
 - **HIGH LIMIT (16QAM):** Sets the upper limit of 16QAM. Use the numeric keys to input value and press the unit soft key or the **ENTER** hard key to complete the input.
 - **HIGH LIMIT (64QAM):** Sets the upper limit of 64QAM. Use the numeric keys to input value and press the unit soft key or the **ENTER** hard key to complete the input.
- Y **TIME ALIGNMENT ERROR:** Sets the limit of time alignment error.
 - **TEST LIMIT:** Enables or disables the test limit. Toggle this soft key between **On** and **Off**.
 - **HIGH LIMIT:** Sets the upper limit. Use the numeric keys to input value and press the unit soft key or the **ENTER** hard key to complete the input.
- Y **RS POWER:** Sets the RS power limit.
 - **TEST LIMITS:** Enables or disables the test limits. Toggle this soft key between **On** and **Off**.
 - **HIGH LIMIT:** Sets the upper limit. Use the numeric keys to input value and press the unit soft key or the **ENTER** hard key to complete the input.
 - **LOW LIMIT:** Sets the lower limit. Use the numeric keys to input value and press the unit soft key or the **ENTER** hard key to complete the input.

n UNWANTED EMISSIONS

Y **OCCUPIED BW:** Sets the test limit parameters.

- **TEST LIMIT:** Enables or disables Pass/Fail results on the display screen. Toggle the **Test Limit** soft key to set it to **On** or **Off**.
- **HIGH LIMIT:** Sets the upper limit of the Pass/Fail criteria. Use the numeric keys to enter a threshold or limit value and press one of the unit soft keys to complete the input.

Y **ACLR:** Sets the test limit parameter.

- **TEST LIMIT:** Enables or disables Pass/Fail results on the display screen. Toggle the **Test Limit** soft key to set it to **On** or **Off**.

Y **SPECTRUM EMISSION MASK:** Sets the test limit parameter.

- **TEST LIMIT:** Enables or disables Pass/Fail results on the display screen. Toggle the **Test Limit** soft key to set it to **On** or **Off**.
- **MASK TYPE:** Selects the mask type among Wide Area BS Category A, Wide Area BS Category B, Local Area BS, and Home BS.

Y **SPURIOUS EMISSIONS:** Sets the test limit parameter.

- **TEST LIMIT:** Enables or disables Pass/Fail results on the display screen. Toggle the **Test Limit** soft key to set it to **On** or **Off**.
- **RANGE TABLE:** Sets the range table parameters.
 - o **RANGE:** Adds a new range number or selects one of the existing range numbers to show or hide the particular frequency range in the range table at the bottom of the screen. Use the numeric keys to enter a range number and press the **Enter** soft key to complete the input. Each time the **Range** soft key is press, it toggles between **On** and **Off**.
 - o **START FREQUENCY:** Sets or changes the start frequency value to be measured for the selected range number in the Range menu. Use the numeric keys to enter a value and press one of the unit soft keys.
 - o **STOP FREQUENCY:** Sets or changes the stop frequency value to be measured for the selected range number in the Range menu. Use the numeric keys to enter a value and press one of the unit soft keys.
 - o **START LIMIT:** Sets the start value of the limit line for the displayed range.
 - o **STOP LIMIT:** Sets the stop value of the limit line for the displayed range.
 - o **ATTENUATION:** Sets the attenuation value in the multiple of 5.
 - o **RBW:** Sets the resolution bandwidth for the selected range number in the Range menu.

- **VBW:** Sets the video bandwidth for the selected range number in the Range menu.

Measurement Procedure

| Step | Description |
|--|---|
| <p>1. Select the mode</p> <p>MEASURE</p> <p>[Auto Measure]</p> <p>[Conformance Test]</p> | <p>Press the MEASURE hot key.</p> <p>Press the Auto Measure soft key.</p> <p>Press the Conformance Test soft key.</p> |
| <p>2. Set the measurement parameters</p> <p>MEASURE SETUP</p> <p>[Bandwidth]</p> <p>[1.4 MHz], [3 MHz], [5 MHz], [10 MHz], [15 MHz], or [20 MHz]</p> <p>[Freq/Channel]</p> <p>[Unit]</p> <p><Freq> or <Channel></p> <p><u>When Freq is selected:</u></p> <p>[Center Frequency]</p> <p>Enter a value</p> <p>[GHz], [MHz], [kHz], or [Hz]</p> <p><u>When Channel is selected:</u></p> <p>[Channel Standard]</p> <p>Select a channel standard</p> <p>[Select] or ENTER</p> <p>[Channel Number]</p> <p>Enter a value</p> <p>[Forward]</p> | <p>Press the MEASURE SETUP hot key.</p> <p>Press the Bandwidth soft key.</p> <p>Press one of the soft keys to select.</p> <p>Press the Freq/Channel soft key.</p> <p>Press the Unit soft key. Toggle this key between Freq and Channel. A set of Freq/Dist screen menu changes accordingly.</p> <p>Press the Center Frequency soft key.</p> <p>Use the numeric keys, the rotary knob, or the arrow keys.</p> <p>When using the numeric keys, the input is completed by selecting one of the unit soft keys.</p> <p>Press the Channel Standard soft key. If this channel standard shows its default setting Band Global, go set the channel number directly.</p> <p>Press the arrow keys, rotate the knob, or press the Page Up and Page Down soft keys to highlight a frequency band to select.</p> <p>Press the Select soft key or the ENTER hard key.</p> <p>Press the Channel Number soft key.</p> <p>Use the numeric keys to input value and press the Forward soft key to complete the input. The instrument automatically displays its corresponding center frequency value for the channel number.</p> <p>Press the Sector soft key. Each time this key is pressed,</p> |

| | |
|---|---|
| <p>[Sector] <Alpha>, <Beta>, or <Gamma></p> | <p>selection changes among Alpha, Beta, and Gamma.</p> |
| <p>[Save Result] [File Name]</p> | <p>Press the Save Result soft key. Press the File Name soft key to assign a specific name to the test result.</p> |
| <p>[Save to] <Internal> or <USB></p> | <p>Press the Save to soft key to select where to save the test result. Toggle this soft key between Internal and USB.</p> |
| <p>[Save Screen] <All> or <Fail></p> | <p>Press the Save Screen soft key to choose the save option. Toggle this soft key between All and Fail. This key is activated only when the Save to is set to USB.</p> |
| <p>[Run]</p> | <p>Press the Run soft key to run a test.</p> |

LTE - TDD Auto Measure Conformance Test Procedure

MEASURE SETUP



- n **BANDWIDTH:** Selects the nominal channel bandwidth to be measured among **1.4 MHz**, **3 MHz**, **5 MHz**, **10 MHz**, **15 MHz**, and **20 MHz**.
- n **FREQ/CHANNEL:** Sets the frequency/channel to be measured.
- Y **UNIT:** Determines the way how to set the frequency band either with standard band or custom frequency band. Toggling this key between **Freq** and **Channel** changes a set of Freq/Dist screen menu automatically. When the **Channel** is selected, the instrument sets the **Channel Standard** setting to **Band Global** as default so that the user can set the **Channel Number** directly without choosing a standard channel band from the list.
- Y **CENTER FREQUENCY:** Changes the center frequency setting. Use the rotary knob or the arrow keys. Or use the numeric keys to input a certain value and press one of the unit soft keys to complete the input.
- Y **FREQUENCY STEP:** Defines the amount of frequency to be increased or decreased when using the rotary knob or the arrow keys to change the **Center Frequency**. This frequency step size can be entered by using numeric keys and the unit soft keys.
- Y **CHANNEL NUMBER:** Enters a channel number. The instrument automatically displays its corresponding center frequency value for the channel number.
- Y **CHANNEL STEP:** Defines the amount of channel to be increased or decreased when using the rotary knob or the arrow keys to change the **Channel Number**. This channel step size can be entered by using numeric keys and the **Enter** soft key.
- Y **CHANNEL STANDARD:** When the channel standard is selected from the list, the center frequency information on the display screen will be mapped accordingly to the selected channel standard. The channel standards available in the instrument are listed in the

Appendix C – Band, Frequency & Channel Standard.

- n **SECTOR:** Sets the sector option among **Alpha**, **Beta**, and **Gamma**.
- n **EXTERNAL OFFSET:** Sets an external offset value. An offset consists of a cable loss and a user offset and the measurement result shows the value reflecting both offset values. When the external offset value is set at 40 dB in the Spectrum mode, the measurement result compensates 40 dB at both the Spectrum Analyzer and Signal Analyzer modes.
- n **SAVE RESULT:** Sets parameters for saving measurement results. The instrument automatically saves measurement results in *.CSV format as well so that they can be imported in application software that supports the CSV format.
 - Y **FILE NAME:** Sets the measurement result file name.
 - Y **SAVE TO:** Sets the destination where the result to be saved, **Internal** or **USB**.
 - Y **SAVE SCREEN:** Selects what results to be saved into a USB drive. Toggle this soft key between **All** for all the measurement items and **Fail** for failed items only. This key is activated only when the **Save to** is set to **USB**.
- n **RUN:** Starts a conformance test.
- n **ABORT:** Stops a conformance test.

MAINTENANCE TEST

The Auto Measure function of the JD740A series allows a complete signal profiling covering RF characterization and modulation quality parameters of up to 20 different carriers, particularly useful on an overlay architecture where base stations are transmitting in different frequencies.

Following settings are required only when you run Auto Measure on the instrument using “Current” configuration setting. Additional settings are not required when you run Auto Measure using a scenario generated in the PC application software, JDViewer.

Setting Frequency

| Step | Description |
|---|---|
| 1. Set the frequency FREQ/DIST [Unit] <Freq> or <Channel> | Press the FREQ/DIST hard key. Press the Unit soft key. Toggle this key between Freq and Channel . A set of Freq/Dist screen menu changes |

| | |
|---|--|
| <p><u>When Freq is selected:</u></p> <p>[Center Frequency] Enter a value [GHz], [MHz], [kHz], or [Hz]</p> <p><u>When Channel is selected:</u></p> <p>[Channel Standard]</p> <p>Select a channel standard</p> <p>[Select] or ENTER</p> <p>[Channel Number] Enter a value [Forward]</p> | <p>accordingly.</p> <p>Press the Center Frequency soft key. Use the numeric keys, the rotary knob, or the arrow keys. When using the numeric keys, the input is completed by selecting one of the unit soft keys.</p> <p>Press the Channel Standard soft key. If this channel standard shows its default setting Band Global, go set the channel number directly. Press the arrow keys, rotate the knob, or press the Page Up and Page Down soft keys to highlight a frequency band to select. Press the Select soft key or the ENTER hard key.</p> <p>Press the Channel Number soft key. Use the numeric keys to input value and press the Forward soft key to complete the input. The instrument automatically displays its corresponding center frequency value for the channel number.</p> |
|---|--|

FREQ/DIST



- n **UNIT:** Determines the way how to set the frequency band either with standard band or custom frequency band. Toggling this key between **Freq** and **Channel** changes a set of Freq/Dist screen menu automatically. When the **Channel** is selected, the instrument sets the **Channel Standard** setting to **Band Global** as default so that the user can set the **Channel Number** directly without choosing a standard channel band from the list.
- n **CENTER FREQUENCY:** Changes the center frequency setting. Use the rotary knob or the arrow keys. Or use the numeric keys to input a certain value and press one of the unit soft keys to complete the input.
- n **FREQUENCY STEP:** Defines the amount of frequency to be increased or decreased when using the rotary knob or the arrow keys to change the **Center Frequency**. This frequency step size can be entered by using numeric keys and the unit soft keys.
- n **CHANNEL NUMBER:** Enters a channel number. The instrument automatically displays its corresponding center frequency value for the channel number.
- n **CHANNEL STEP:** Defines the amount of channel to be increased or decreased when using the rotary knob or the arrow keys to change the **Channel Number**. This channel step size can be

entered by using numeric keys and the **Enter** soft key.

- n **CHANNEL STANDARD:** When the channel standard is selected from the list, the center frequency information on the display screen will be mapped accordingly to the selected channel standard. The channel standards available in the instrument are listed in the Appendix C – Band, Frequency & Channel Standard.

Setting Limit



This hot key is used to set the threshold value for the limit line on the display screen. It turns on or off the limit or band limit settings of the measurement for pass/fail indication. The user input window must be inactive first to get the Limit hot key function other than the number input.

| Step | Description |
|---|---|
| 1. Set the RF test limit LIMIT [RF Test Limits] [Channel Power] [Test Limits] <On> or <Off> [High Limit] Enter a value [dBm] or ENTER [Low Limit] Enter a value [dBm] or ENTER [Occupied BW] [Test Limit] <On> or <Off> [High Limit] Enter a value [MHz], [kHz], or [Hz] [Spectrum Emission Mask] [Test Limit] <On> or <Off> [ACLR] [Test Limit] <On> or <Off> | Press the LIMIT hot key. Press the RF Test Limits soft key. Press the Channel Power soft key. Press the Test Limits soft key to toggle between On and Off and select one. Press the High Limit soft key to set the upper limit of the Pass/Fail criteria. Use the numeric keys to input value. Press the unit soft key or the ENTER hard key. Press the Low Limit soft key to set the lower limit of the Pass/Fail criteria. Use the numeric keys to input value. Press the unit soft key or the ENTER hard key. Press the Occupied BW soft key. Press the Test Limit soft key to toggle between On and Off and select one. Press the High Limit soft key to set the upper limit of the Pass/Fail criteria. Use the numeric keys to input value. Press the unit soft key to select. Press the Spectrum Emission Mask soft key. Press the Test Limit soft key to toggle between On and Off and select one. Press the ACLR soft key. Press the Test Limit soft key to toggle between On and Off and select one. |

| | |
|--|---|
| <p>[Multi-ACLR] [Test Limit] <On> or <Off></p> <p>[Spurious Emissions] [Test Limit] <On> or <Off></p> | <p>Press the Multi-ALPR soft key. Press the Test Limit soft key to toggle between On and Off and select one.</p> <p>Press the Spurious Emissions soft key. Press the Test Limit soft key to toggle between On and Off and select one.</p> |
| <p>2. Select the power vs time test limit LIMIT [PvsT Test Limits] [Slot Avg Power] [Test Limits] <On> or <Off> [High Limit] [Low Limit]</p> <p>[Off Power] [Test Limits] <On> or <Off> [High Limit]</p> <p>[Transition Period] [Test Limits] <On> or <Off> [High Limit]</p> | <p>Press the LIMIT hot key. Press the PvsT Test Limits soft key. Press the Slot Avg Power soft key. Press the Test Limits soft key. Toggle between On and Off. Use the numeric keys and input a number in ppm. Use the numeric keys and input a number in ppm.</p> <p>Press the Off Power soft key. Press the Test Limits soft key. Toggle between On and Off. Press the High Limit soft key to input value.</p> <p>Press the Transition Period soft key. Press the Test Limits soft key. Toggle between On and Off. Press the High Limit soft key to input value.</p> |
| <p>3. Set the modulation test limit LIMIT [Modulation Test Limits] [Frequency Error] [Test Limits] <On> or <Off> [High Limit] [Low Limit]</p> <p>[EVM] [PDSCH EVM] [Test Limits] <On> or <Off> [High Limit (QPSK)] [High Limit (16QAM)] [High Limit (64QAM)]</p> | <p>Press the LIMIT hot key. Press the Modulation Test Limits soft key. Press the Frequency Error soft key. Press the Test Limits soft key. Toggle between On and Off. Use the numeric keys to input value. Use the numeric keys to input value.</p> <p>Press the EVM soft key. Press the PDSCH EVM soft key. Press the Test Limits soft key. Toggle between On and Off. Press the High Limit (QPSK) soft key to input value. Press the High Limit (16QAM) soft key to input value. Press the High Limit (64QAM) soft key to input value.</p> |

| | |
|--|---|
| <p>[Data EVM RMS] [Test Limits] <On> or <Off> [High Limit]</p> | <p>Press the Data EVM RMS soft key. Press the Test Limits soft key. Toggle between On and Off. Press the High Limit soft key to input value.</p> |
| <p>[Data EVM Peak] [Test Limits] <On> or <Off> [High Limit]</p> | <p>Press the Data EVM Peak soft key. Press the Test Limits soft key. Toggle between On and Off. Press the High Limit soft key to input value.</p> |
| <p>[RS EVM] [Test Limits] <On> or <Off> [High Limit]</p> | <p>Press the RS EVM soft key. Press the Test Limits soft key. Toggle between On and Off. Use the numeric keys and input.</p> |
| <p>[P-SS EVM] [Test Limits] <On> or <Off> [High Limit]</p> | <p>Press the P-SS EVM soft key. Press the Test Limits soft key. Toggle between On and Off. Use the numeric keys and input.</p> |
| <p>[S-SS EVM] [Test Limits] <On> or <Off> [High Limit]</p> | <p>Press the S-SS EVM soft key. Press the Test Limits soft key. Toggle between On and Off. Use the numeric keys and input.</p> |
| <p>[Power] [DL RS Power] [Test Limit] <On> or <Off> [High Limit] [Low Limit]</p> | <p>Press the Power soft key. Press the DL RS Power soft key. Press the Test Limit soft key. Toggle between On and Off. Use the numeric keys and input. Use the numeric keys and input.</p> |
| <p>[P-SS Power] [Test Limits] <On> or <Off> [High Limit] [Low Limit]</p> | <p>Press the P-SS Power soft key. Press the Test Limit soft key. Toggle between On and Off. Use the numeric keys and input. Use the numeric keys and input.</p> |
| <p>[S-SS Power] [Test Limits] <On> or <Off> [High Limit] [Low Limit]</p> | <p>Press the S-SS Power soft key. Press the Test Limit soft key. Toggle between On and Off. Use the numeric keys and input. Use the numeric keys and input.</p> |

| | |
|---|--|
| <p>[PBCH Power] [Test Limits] <On> or <Off> [High Limit] [Low Limit]</p> <p>[Subframe Power] [Test Limits] <On> or <Off> [High Limit] [Low Limit]</p> <p>[OFDM Symbol Power] [Test Limits] <On> or <Off> [High Limit] [Low Limit]</p> <p>[Time Alignment Error] [Test Limits] <On> or <Off> [High Limit]</p> <p>[Time Error] [Test Limits] <On> or <Off> [High Limit] [Low Limit]</p> <p>[IQ Origin Offset] [Test Limit] <On> or <Off> [High Limit]</p> | <p>Press the PBCH Power soft key. Press the Test Limit soft key. Toggle between On and Off. Use the numeric keys and input. Use the numeric keys and input.</p> <p>Press the Subframe Power soft key. Press the Test Limit soft key. Toggle between On and Off. Use the numeric keys and input. Use the numeric keys and input.</p> <p>Press the OFDM Symbol Power soft key. Press the Test Limit soft key. Toggle between On and Off. Use the numeric keys and input. Use the numeric keys and input.</p> <p>Press the Time Alignment Error soft key. Press the Test Limits soft key. Toggle between On and Off. Use the numeric keys to input value.</p> <p>Press the Time Error soft key. Press the Test Limits soft key. Toggle between On and Off. Use the numeric keys to input value. Use the numeric keys to input value.</p> <p>Press the IQ Origin Offset soft key. Press the Test Limit soft key. Toggle between On and Off. Use the numeric keys and input a number in dB.</p> |
| <p>4. Enable beep LIMIT [Beep] <On> or <Off></p> | <p>Press the LIMIT hot key. Press the Beep soft key to toggle between On and Off and select one. This will make audible alarm if the measurement result goes beyond the limit.</p> |

n **CHANNEL POWER:** Sets the test limit parameters.

Y **TEST LIMITS:** Enables or disables Pass/Fail results on the display screen. Toggle the **Test Limits** soft key to set it to **On** or **Off**.

Y **HIGH LIMIT:** Sets the upper limit of the Pass/Fail criteria. Use the numeric keys to enter a

- threshold or limit value and press the **dBm** unit soft key or the **ENTER** hard key to complete the input.
- Y **LOW LIMIT:** Sets the lower limit of the Pass/Fail criteria. Use the numeric keys to enter a threshold or limit value and press the **dBm** unit soft key or the **ENTER** hard key to complete the input.
 - n **OCCUPIED BW:** Sets the test limit parameters.
 - Y **TEST LIMIT:** Enables or disables Pass/Fail results on the display screen. Toggle the **Test Limit** soft key to set it to **On** or **Off**.
 - Y **HIGH LIMIT:** Sets the upper limit of the Pass/Fail criteria. Use the numeric keys to enter a threshold or limit value and press one of the unit soft keys to complete the input.
 - n **SPECTRUM EMISSION MASK:** Sets the test limit parameter.
 - Y **TEST LIMIT:** Enables or disables Pass/Fail results on the display screen. Toggle the **Test Limit** soft key to set it to **On** or **Off**.
 - n **ACLR:** Sets the test limit parameter.
 - Y **TEST LIMIT:** Enables or disables Pass/Fail results on the display screen. Toggle the **Test Limit** soft key to set it to **On** or **Off**.
 - n **MULTI-ACLR:** Sets the test limit parameter.
 - Y **TEST LIMIT:** Enables or disables Pass/Fail results on the display screen. Toggle the **Test Limit** soft key to set it to **On** or **Off**.
 - n **SPURIOUS EMISSIONS:** Sets the test limit parameter.
 - Y **TEST LIMIT:** Enables or disables Pass/Fail results on the display screen. Toggle the **Test Limit** soft key to set it to **On** or **Off**.
 - n **SLOT AVG POWER:** Sets the slot average power limit.
 - Y **TEST LIMITS:** Enables or disables the test limit(s). Toggle the **Test Limits** soft key between **On** and **Off**.
 - Y **HIGH LIMIT:** Sets the upper limit. Use the numeric keys to input value and press the unit soft key or the **ENTER** hard key to complete the input.
 - Y **LOW LIMIT:** Sets the lower limit. Use the numeric keys to input value and press the unit soft key or the **ENTER** hard key to complete the input.
 - n **OFF POWER:** Sets the off power limit.
 - Y **TEST LIMITS:** Enables or disables the test limit. Toggle this soft key between **On** and **Off**.
 - Y **HIGH LIMIT:** Sets the upper limit of the off power. Use the numeric keys to input value and press the unit soft key or the **ENTER** hard key to complete the input.

- n **TRANSITION PERIOD:** Sets the transition period limit.
- Y **TEST LIMITS:** Enables or disables the test limit. Toggle this soft key between **On** and **Off**.
- Y **HIGH LIMIT:** Sets the upper limit of the transition period. Use the numeric keys to input value and press the unit soft key or the **ENTER** hard key to complete the input.
- n **FREQUENCY ERROR:** Sets the frequency error limit.
- Y **TEST LIMITS:** Enables or disables the test limits. Toggle the **Test Limits** soft key between **On** and **Off**.
- Y **HIGH LIMIT:** Sets the upper limit. Use the numeric keys to input value and press the unit soft key or the **ENTER** hard key to complete the input.
- Y **LOW LIMIT:** Sets the lower limit. Use the numeric keys to input value and press the unit soft key or the **ENTER** hard key to complete the input.
- n **EVM:** Sets limits for Error Vector Magnitude.
- Y **PDSCH EVM:** Sets the limit of the PDSCH EVM.
 - **TEST LIMITS:** Enables or disables the test limit. Toggle this key between **On** and **Off**.
 - **HIGH LIMIT (QPSK):** Sets the upper limit of QPSK. Use the numeric keys to input value and press the unit soft key or the **ENTER** hard key to complete the input.
 - **HIGH LIMIT (16QAM):** Sets the upper limit of 16QAM. Use the numeric keys to input value and press the unit soft key or the **ENTER** hard key to complete the input.
 - **HIGH LIMIT (64QAM):** Sets the upper limit of 64QAM. Use the numeric keys to input value and press the unit soft key or the **ENTER** hard key to complete the input.
- Y **DATA EVM RMS:** Sets the rms limit of the Data EVM.
 - **TEST LIMITS:** Enables or disables the test limit. Toggle this key between **On** and **Off**.
 - **HIGH LIMIT:** Sets the upper limit. Use the numeric keys to input value and press the unit soft key or the **ENTER** hard key to complete the input.
- Y **DATA EVM PEAK:** Sets the peak limit of the Data EVM.
 - **TEST LIMITS:** Enables or disables the test limit. Toggle this key between **On** and **Off**.
 - **HIGH LIMIT:** Sets the upper limit. Use the numeric keys to input value and press the unit soft key or the **ENTER** hard key to complete the input.
- Y **RS EVM:** Sets the RS EVM.
 - **TEST LIMITS:** Enables or disables the test limits. Toggle this key between **On** and **Off**.
 - **HIGH LIMIT:** Sets the upper limit. Use the numeric keys to input value and press the unit soft key or the **ENTER** hard key to complete the input.

- Y **P-SS EVM:** Sets the P-SS EVM.
 - **TEST LIMITS:** Enables or disables the test limits. Toggle this key between **On** and **Off**.
 - **HIGH LIMIT:** Sets the upper limit. Use the numeric keys to input value and press the unit soft key or the **ENTER** hard key to complete the input.
- Y **S-SS EVM:** Sets the S-SS EVM.
 - **TEST LIMITS:** Enables or disables the test limits. Toggle this key between **On** and **Off**.
 - **HIGH LIMIT:** Sets the upper limit. Use the numeric keys to input value and press the unit soft key or the **ENTER** hard key to complete the input.
- n **POWER:** Set power limits.
 - Y **DL RS POWER:** Sets the Downlink RS power limit.
 - **TEST LIMITS:** Enables or disables the test limits. Toggle this key between **On** and **Off**.
 - **HIGH LIMIT:** Sets the upper limit. Use the numeric keys to input value and press the unit soft key or the **ENTER** hard key to complete the input.
 - **LOW LIMIT:** Sets the lower limit. Use the numeric keys to input value and press the unit soft key or the **ENTER** hard key to complete the input.
 - Y **P-SS POWER:** Sets the P-SS power limit.
 - **TEST LIMITS:** Enables or disables the test limits. Toggle this key between **On** and **Off**.
 - **HIGH LIMIT:** Sets the upper limit. Use the numeric keys to input value and press the unit soft key or the **ENTER** hard key to complete the input.
 - **LOW LIMIT:** Sets the lower limit. Use the numeric keys to input value and press the unit soft key or the **ENTER** hard key to complete the input.
 - Y **S-SS POWER:** Sets the S-SS power limit.
 - **TEST LIMITS:** Enables or disables the test limits. Toggle this key between **On** and **Off**.
 - **HIGH LIMIT:** Sets the upper limit. Use the numeric keys to input value and press the unit soft key or the **ENTER** hard key to complete the input.
 - **LOW LIMIT:** Sets the lower limit. Use the numeric keys to input value and press the unit soft key or the **ENTER** hard key to complete the input.
 - Y **PBCH POWER:** Sets the PBCH power limit.
 - **TEST LIMITS:** Enables or disables the test limits. Toggle this key between **On** and **Off**.
 - **HIGH LIMIT:** Sets the upper limit. Use the numeric keys to input value and press the unit soft key or the **ENTER** hard key to complete the input.
 - **LOW LIMIT:** Sets the lower limit. Use the numeric keys to input value and press the unit soft key or the **ENTER** hard key to complete the input.

soft key or the **ENTER** hard key to complete the input.

Y **SUBFRAME POWER:** Sets the subframe power limit.

- **TEST LIMITS:** Enables or disables the test limits. Toggle this key between **On** and **Off**.
- **HIGH LIMIT:** Sets the upper limit. Use the numeric keys to input value and press the unit soft key or the **ENTER** hard key to complete the input.
- **LOW LIMIT:** Sets the lower limit. Use the numeric keys to input value and press the unit soft key or the **ENTER** hard key to complete the input.

Y **OFDM SYMBOL POWER:** Sets the OFDM symbol power limit.

- **TEST LIMITS:** Enables or disables the test limits. Toggle this key between **On** and **Off**.
- **HIGH LIMIT:** Sets the upper limit. Use the numeric keys to input value and press the unit soft key or the **ENTER** hard key to complete the input.
- **LOW LIMIT:** Sets the lower limit. Use the numeric keys to input value and press the unit soft key or the **ENTER** hard key to complete the input.

n **TIME ALIGNMENT ERROR:** Sets the limit of time alignment error.

Y **TEST LIMIT:** Enables or disables the test limit. Toggle this soft key between **On** and **Off**.

Y **HIGH LIMIT:** Sets the upper limit. Use the numeric keys to input value and press the unit soft key or the **ENTER** hard key to complete the input.

n **TIME ERROR:** Sets the limit of the Time Error.

Y **TEST LIMITS:** Enables or disables the test limits. Toggle this soft key between **On** and **Off**.

Y **HIGH LIMIT:** Sets the upper limit. Use the numeric keys to input value and press the unit soft key or the **ENTER** hard key to complete the input.

Y **LOW LIMIT:** Sets the lower limit. Use the numeric keys to input value and press the unit soft key or the **ENTER** hard key to complete the input.

n **IQ ORIGIN OFFSET:** Sets the limit of I/Q origin offset.

Y **TEST LIMIT:** Enables or disables the test limit. Toggle this soft key between **On** and **Off**.

Y **HIGH LIMIT:** Sets the upper limit. Use the numeric keys to input value and press the unit soft key or the **ENTER** hard key to complete the input.

Measurement Procedure

| Step | Description |
|--------------------------------------|-----------------------------------|
| 1. Select the mode MEASURE | Press the MEASURE hot key. |

| | |
|---|--|
| <p>[Auto Measure] [Maintenance Test]</p> | <p>Press the Auto Measure soft key. Press the Maintenance Test soft key.</p> |
| <p>2. Set the measurement parameters MEASURE SETUP [Configuration] <Current> or <Scenario></p> <p>[Load Scenario]</p> <p>[Test Time] <Now> or <Schedule></p> <p>[Set Timing]</p> <p> [Start Time] [Stop Time] [Time Interval]</p> <p>[Save Result] [File Name]</p> <p> [Save to] <Internal> or <USB></p> <p> [Save Screen] <All> or <Fail></p> <p>[Settings] [Bandwidth] [1.4 MHz], [3 MHz], [5 MHz], [10 MHz], [15 MHz], or [20 MHz]</p> <p> [Cell ID] <Auto> or <Manual> Enter a value [Enter]</p> <p> [Antenna Port] <Auto>, <0>, or <1></p> <p>[Run Test]</p> | <p>Press the MEASURE SETUP hot key. Press the Configuration soft key to select the mode. Toggle this soft key between Current and Scenario.</p> <p>Press the Load Scenario soft key to load a scenario file. This key is active only when the Configuration is set to Scenario.</p> <p>Press the Test Time soft key to select when to run a test. Toggle this soft key between Now and Schedule.</p> <p>Press the Set Timing soft key. This key is activated only when the Test Time is set to Schedule. Press the Start Time soft key. Press the Stop Time soft key. Press the Time Interval soft key.</p> <p>Press the Save Result soft key. Press the File Name soft key to assign a specific name to the test result. Press the Save to soft key to select where to save the test result. Toggle this soft key between Internal and USB. Press the Save Screen soft key to choose the save option. Toggle this soft key between All and Fail. This key is activated only when the Save to is set to USB.</p> <p>Press the Settings soft key. Press the Bandwidth soft key. Press one of the soft keys to select.</p> <p>Press the Cell ID soft key. Toggle between Auto and Manual. Use the numeric keys to set the Cell ID manually. Press the Enter soft key.</p> <p>Press the Antenna Port soft key. Each time this soft key is pressed, selection changes among Auto, 0, and 1.</p> <p>Press the Run Test soft key to run a test.</p> |

LTE - TDD Auto Measurement Maintenance Test Procedure

MEASURE SETUP



- n **CONFIGURATION:** Selects the measurement configuration to be used. When the **Current** is selected, the instrument runs a test using current carrier frequency (single carrier) and determines pass/fail based on the instrument's limit settings. Select the **Scenario** to run a test with a programmed scenario.
- n **LOAD SCENARIO:** Selects and loads a scenario file generated by the PC application software, JDViewer. This soft key is activated only when the **Configuration** is set to **Scenario**.
- n **TEST TIME:** Selects the test time. When **Now** is selected, the instrument runs a test only once. When **Schedule** is selected, the instrument repeats tests as defined in the **Set Timing** menu.
- n **SET TIMING:** Sets the **Start Time**, **Stop Time**, and **Time Interval** of a scheduled measurement. This soft key is activated only when the **Test Time** is set to **Schedule**.
- n **SAVE RESULT:** Sets parameters for saving measurement results. The instrument automatically saves measurement results in *.CSV format as well so that they can be imported in application software that supports the CSV format.
 - Y **FILE NAME:** Sets the measurement result file name.
 - Y **SAVE TO:** Sets the destination where the result to be saved, **Internal** or **USB**.
 - Y **SAVE SCREEN:** Selects what results to be saved into a USB drive. Toggle this soft key between **All** for all the measurement items and **Fail** for failed items only. This key is activated only when the **Save to** is set to **USB**.
- n **SETTINGS:** Sets the Cell ID and the Antenna Port.
 - Y **BANDWIDTH:** Selects the nominal channel bandwidth to be measured among **1.4 MHz**, **3 MHz**, **5 MHz**, **10 MHz**, **15 MHz**, and **20 MHz**.
 - Y **CELL ID:** Enables or disables automatic detection of the Cell ID of the transmitted LTE signal. Manually setting the Cell ID to a specific one can speed up to get synchronization with BTS.
 - **AUTO:** Detects the Cell ID automatically.
 - **MANUAL:** Sets the Cell ID to a specific one.
 - Y **ANTENNA PORT:** Sets the antenna port number automatically or manually. Each time this soft key is pressed, selection changes among **Auto**, **0**, and **1**.
 - Y **EXTERNAL OFFSET:** Sets an external offset value. An offset consists of a cable loss and a user offset and the measurement result shows the value reflecting both offset values. When the external offset value is set at 40 dB in the Spectrum mode, the measurement result compensates 40 dB at both the Spectrum Analyzer and Signal Analyzer modes.
- n **RUN TEST:** Starts a test.

Setting Display



- n **DISPLAY:** Changes the display option. After running automatic measurement, toggle this key between **Results** and **Settings**.
 - Y **RESULTS:** Shows actual measurement results on the display screen.
 - Y **SETTINGS:** Shows measurement parameters set for the automatic measurement.
- n **DISPLAY RESULTS:** Changes the display format of measurement results. This key becomes activated when the **Results** is set as the display option. Toggle this key between **Full** and **Quick** to check measurement results in different format.
 - Y **FULL:** Shows detailed measurement results, including actual measurement readings with pass/fail color indication.
 - Y **QUICK:** Shows quick view of pass/fail results.
- n **VIEW CARRIER:** Selects a carrier to be displayed among up to 10 carriers. This key becomes activated when the **Results** is set as the display option.

SIGNAL PERFORMANCE TEST

Unlike the other measurement modes of the auto measurement, the Signal Performance Test runs measurement continuously.

Setting Frequency

| Step | Description |
|--|--|
| 1. Set the frequency FREQ/DIST [Unit] <Freq> or <Channel> <u>When Freq is selected:</u> [Center Frequency] Enter a value [GHz], [MHz], [kHz], or [Hz] | Press the FREQ/DIST hard key. Press the Unit soft key. Toggle this key between Freq and Channel . A set of Freq/Dist screen menu changes accordingly. Press the Center Frequency soft key. Use the numeric keys, the rotary knob, or the arrow keys. When using the numeric keys, the input is completed by |

| | |
|---|--|
| <p><i>When Channel is selected:</i></p> <p>[Channel Standard]</p> <p>Select a channel standard</p> <p>[Select] or ENTER</p> <p>[Channel Number]</p> <p>Enter a value</p> <p>[Forward]</p> | <p>selecting one of the unit soft keys.</p> <p>Press the Channel Standard soft key. If this channel standard shows its default setting Band Global, go set the channel number directly.</p> <p>Press the arrow keys, rotate the knob, or press the Page Up and Page Down soft keys to highlight a frequency band to select.</p> <p>Press the Select soft key or the ENTER hard key.</p> <p>Press the Channel Number soft key.</p> <p>Use the numeric keys to input value and press the Forward soft key to complete the input. The instrument automatically displays its corresponding center frequency value for the channel number.</p> |
|---|--|

FREQ/DIST

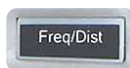

- n **UNIT:** Determines the way how to set the frequency band either with standard band or custom frequency band. Toggling this key between **Freq** and **Channel** changes a set of Freq/Dist screen menu automatically. When the **Channel** is selected, the instrument sets the **Channel Standard** setting to **Band Global** as default so that the user can set the **Channel Number** directly without choosing a standard channel band from the list.
- n **CENTER FREQUENCY:** Changes the center frequency setting. Use the rotary knob or the arrow keys. Or use the numeric keys to input a certain value and press one of the unit soft keys to complete the input.
- n **FREQUENCY STEP:** Defines the amount of frequency to be increased or decreased when using the rotary knob or the arrow keys to change the **Center Frequency**. This frequency step size can be entered by using numeric keys and the unit soft keys.
- n **CHANNEL NUMBER:** Enters a channel number. The instrument automatically displays its corresponding center frequency value for the channel number.
- n **CHANNEL STEP:** Defines the amount of channel to be increased or decreased when using the rotary knob or the arrow keys to change the **Channel Number**. This channel step size can be entered by using numeric keys and the **Enter** soft key.
- n **CHANNEL STANDARD:** When the channel standard is selected from the list, the center frequency information on the display screen will be mapped accordingly to the selected channel standard. The channel standards available in the instrument are listed in the Appendix C – Band, Frequency & Channel Standard.

Setting Sweep Mode



This hot key is used to set the sweep parameters. The user input window must be inactive first to get the Sweep hot key function other than the number input.

- n **SWEEP MODE:** Sets the sweep method. Toggle between **Continue** and **Single**.

| Step | Description |
|--|---|
| 1. Set the sweep mode SWEEP [Sweep Mode] | Press the SWEEP hot key. Press the Sweep Mode soft key. Toggle between Continue and Single . |

Setting Limit



This hot key is used to set the threshold value for the limit line on the display screen. It turns on or off the limit or band limit settings of the measurement for pass/fail indication. The user input window must be inactive first to get the Limit hot key function other than the number input.

| Step | Description |
|---|---|
| 1. Set the RF test limit LIMIT [RF Test Limits] [Channel Power] [Test Limits] <On> or <Off> [High Limit] Enter a value [dBm] or ENTER [Low Limit] Enter a value [dBm] or ENTER | Press the LIMIT hot key. Press the RF Test Limits soft key. Press the Channel Power soft key. Press the Test Limits soft key to toggle between On and Off and select one. Press the High Limit soft key to set the upper limit of the Pass/Fail criteria. Use the numeric keys to input value. Press the unit soft key or the ENTER hard key. Press the Low Limit soft key to set the lower limit of the Pass/Fail criteria. Use the numeric keys to input value. Press the unit soft key or the ENTER hard key. |
| 2. Set the modulation test limit LIMIT [Modulation Test Limits] [Frequency Error] | Press the LIMIT hot key. Press the Modulation Test Limits soft key. Press the Frequency Error soft key. |

| | |
|--|--|
| <p>[Test Limits] <On> or <Off></p> | <p>Press the Test Limits soft key. Toggle between On and Off.</p> |
| <p>[High Limit]</p> | <p>Use the numeric keys to input value.</p> |
| <p>[Low Limit]</p> | <p>Use the numeric keys to input value.</p> |
| <p>[EVM]</p> | <p>Press the EVM soft key.</p> |
| <p>[PDSCH EVM]</p> | <p>Press the PDSCH EVM soft key.</p> |
| <p>[Test Limits] <On> or <Off></p> | <p>Press the Test Limits soft key. Toggle between On and Off.</p> |
| <p>[High Limit (QPSK)]</p> | <p>Press the High Limit (QPSK) soft key to input value.</p> |
| <p>[High Limit (16QAM)]</p> | <p>Press the High Limit (16QAM) soft key to input value.</p> |
| <p>[High Limit (64QAM)]</p> | <p>Press the High Limit (64QAM) soft key to input value.</p> |
| <p>[RS EVM]</p> | <p>Press the RS EVM soft key.</p> |
| <p>[Test Limits] <On> or <Off></p> | <p>Press the Test Limits soft key. Toggle between On and Off.</p> |
| <p>[High Limit]</p> | <p>Use the numeric keys and input.</p> |
| <p>[P-SS EVM]</p> | <p>Press the P-SS EVM soft key.</p> |
| <p>[Test Limits] <On> or <Off></p> | <p>Press the Test Limits soft key. Toggle between On and Off.</p> |
| <p>[High Limit]</p> | <p>Use the numeric keys and input.</p> |
| <p>[S-SS EVM]</p> | <p>Press the S-SS EVM soft key.</p> |
| <p>[Test Limits] <On> or <Off></p> | <p>Press the Test Limits soft key. Toggle between On and Off.</p> |
| <p>[High Limit]</p> | <p>Use the numeric keys and input.</p> |
| <p>[Power]</p> | <p>Press the Power soft key.</p> |
| <p>[DL RS Power]</p> | <p>Press the DL RS Power soft key.</p> |
| <p>[Test Limit] <On> or <Off></p> | <p>Press the Test Limit soft key. Toggle between On and Off.</p> |
| <p>[High Limit]</p> | <p>Use the numeric keys and input.</p> |
| <p>[Low Limit]</p> | <p>Use the numeric keys and input.</p> |
| <p>[P-SS Power]</p> | <p>Press the P-SS Power soft key.</p> |
| <p>[Test Limits] <On> or <Off></p> | <p>Press the Test Limit soft key. Toggle between On and Off.</p> |
| <p>[High Limit]</p> | <p>Use the numeric keys and input.</p> |
| <p>[Low Limit]</p> | <p>Use the numeric keys and input.</p> |
| <p>[S-SS Power]</p> | <p>Press the S-SS Power soft key.</p> |
| <p>[Test Limits] <On> or <Off></p> | <p>Press the Test Limit soft key. Toggle between On and Off.</p> |

| | |
|--|--|
| <p>[High Limit] [Low Limit]</p> <p>[Time Alignment Error] [Test Limits] <On> or <Off> [High Limit]</p> | <p>Use the numeric keys and input. Use the numeric keys and input.</p> <p>Press the Time Alignment Error soft key. Press the Test Limits soft key. Toggle between On and Off. Use the numeric keys to input value.</p> |
| <p>3. Enable beep LIMIT [Beep] <On> or <Off></p> | <p>Press the LIMIT hot key. Press the Beep soft key to toggle between On and Off and select one. This will make audible alarm if the measurement result goes beyond the limit.</p> |

- n **CHANNEL POWER:** Sets the test limit parameters.
- Y **TEST LIMITS:** Enables or disables Pass/Fail results on the display screen. Toggle the **Test Limits** soft key to set it to **On** or **Off**.
- Y **HIGH LIMIT:** Sets the upper limit of the Pass/Fail criteria. Use the numeric keys to enter a threshold or limit value and press the **dBm** unit soft key or the **ENTER** hard key to complete the input.
- Y **LOW LIMIT:** Sets the lower limit of the Pass/Fail criteria. Use the numeric keys to enter a threshold or limit value and press the **dBm** unit soft key or the **ENTER** hard key to complete the input.
- n **OCCUPIED BW:** *This key is not used in the Signal Performance mode.*
- n **SPECTRUM EMISSION MASK:** *This key is not used in the Signal Performance mode.*
- n **ACLR:** *This key is not used in the Signal Performance mode.*
- n **MULTI-ACLR:** *This key is not used in the Signal Performance mode.*
- n **SPURIOUS EMISSIONS:** *This key is not used in the Signal Performance mode.*
- n **FREQUENCY ERROR:** Sets the frequency error limit.
- Y **TEST LIMITS:** Enables or disables the test limits. Toggle this soft key between **On** and **Off**.
- Y **HIGH LIMIT:** Sets the upper limit. Use the numeric keys to input value and press the unit soft key or the **ENTER** hard key to complete the input.
- Y **LOW LIMIT:** Sets the lower limit. Use the numeric keys to input value and press the unit soft key or the **ENTER** hard key to complete the input.
- n **EVM:** Sets limits for Error Vector Magnitude.
- Y **PDSCH EVM:** Sets the limit of the PDSCH EVM.

- **TEST LIMITS:** Enables or disables the test limit. Toggle this soft key between **On** and **Off**.
 - **HIGH LIMIT (QPSK):** Sets the upper limit of QPSK. Use the numeric keys to input value and press the unit soft key or the **ENTER** hard key to complete the input.
 - **HIGH LIMIT (16QAM):** Sets the upper limit of 16QAM. Use the numeric keys to input value and press the unit soft key or the **ENTER** hard key to complete the input.
 - **HIGH LIMIT (64QAM):** Sets the upper limit of 64QAM. Use the numeric keys to input value and press the unit soft key or the **ENTER** hard key to complete the input.
- Y **DATA EVM RMS:** *This key is not used in the Signal Performance mode.*
- Y **DATA EVM PEAK:** *This key is not used in the Signal Performance mode.*
- Y **RS EVM:** Sets the RS EVM.
- **TEST LIMITS:** Enables or disables the test limits. Toggle this key between **On** and **Off**.
 - **HIGH LIMIT:** Sets the upper limit. Use the numeric keys to input value and press the unit soft key or the **ENTER** hard key to complete the input.
- Y **P-SS EVM:** Sets the P-SS EVM.
- **TEST LIMITS:** Enables or disables the test limits. Toggle this key between **On** and **Off**.
 - **HIGH LIMIT:** Sets the upper limit. Use the numeric keys to input value and press the unit soft key or the **ENTER** hard key to complete the input.
- Y **S-SS EVM:** Sets the S-SS EVM.
- **TEST LIMITS:** Enables or disables the test limits. Toggle this key between **On** and **Off**.
 - **HIGH LIMIT:** Sets the upper limit. Use the numeric keys to input value and press the unit soft key or the **ENTER** hard key to complete the input.
- n **POWER:** Set power limits.
- Y **DL RS POWER:** Sets the Downlink RS power limit.
- **TEST LIMITS:** Enables or disables the test limits. Toggle this key between **On** and **Off**.
 - **HIGH LIMIT:** Sets the upper limit. Use the numeric keys to input value and press the unit soft key or the **ENTER** hard key to complete the input.
 - **LOW LIMIT:** Sets the lower limit. Use the numeric keys to input value and press the unit soft key or the **ENTER** hard key to complete the input.
- Y **P-SS POWER:** Sets the P-SS power limit.
- **TEST LIMITS:** Enables or disables the test limits. Toggle this key between **On** and **Off**.
 - **HIGH LIMIT:** Sets the upper limit. Use the numeric keys to input value and press the

- unit soft key or the **ENTER** hard key to complete the input.
- **LOW LIMIT:** Sets the lower limit. Use the numeric keys to input value and press the unit soft key or the **ENTER** hard key to complete the input.
- Y **S-SS POWER:** Sets the S-SS power limit.
 - **TEST LIMITS:** Enables or disables the test limits. Toggle this key between **On** and **Off**.
 - **HIGH LIMIT:** Sets the upper limit. Use the numeric keys to input value and press the unit soft key or the **ENTER** hard key to complete the input.
 - **LOW LIMIT:** Sets the lower limit. Use the numeric keys to input value and press the unit soft key or the **ENTER** hard key to complete the input.
- Y **PBCH POWER:** *This key is not used in the Signal Performance mode.*
- Y **SUBFRAME POWER:** *This key is not used in the Signal Performance mode.*
- Y **OFDM SYMBOL POWER:** *This key is not used in the Signal Performance mode.*
- Y **FRAME AVG POWER:** *This key is not used in the Signal Performance mode.*
- n **TIME ALIGNMENT ERROR:** Sets the limit of time alignment error.
 - Y **TEST LIMIT:** Enables or disables the test limit. Toggle this soft key between **On** and **Off**.
 - Y **HIGH LIMIT:** Sets the upper limit. Use the numeric keys to input value and press the unit soft key or the **ENTER** hard key to complete the input.
- n **TIME ERROR:** *This key is not used in the Signal Performance mode.*
- n **IQ ORIGIN OFFSET:** *This key is not used in the Signal Performance mode.*

Measurement Procedure

| Step | Description |
|---|--|
| 1. Select the mode MEASURE [Auto Measure] [Signal Performance] | Press the MEASURE hot key. Press the Auto Measure soft key. Press the Signal Performance soft key. |
| 2. Set the measurement parameters MEASURE SETUP [Cell ID] <Auto> or <Manual> Enter a value [Enter] [Antenna Port] <Auto> , <0> , or <1> | Press the MEASURE SETUP hot key. Press the Cell ID soft key. Toggle between Auto and Manual . Use the numeric keys to set the Cell ID manually. Press the Enter soft key. Press the Antenna Port soft key. Each time this soft key is pressed, selection changes among Auto , 0 , and 1 . |

| | |
|---|--|
| [Bandwidth] [1.4 MHz], [3 MHz], [5 MHz], [10 MHz], [15 MHz], or [20 MHz] | Press the Bandwidth soft key. Press one of the soft keys to select. |
| [RF Profile] <On> or <Off> | Press the RF Profile soft key. Toggle this key between On and Off . |
| [Modulation Profile] <On> or <Off> | Press the Modulation Profile soft key. Toggle this key between On and Off . |
| [MIMO Profile] <On> or <Off> | Press the MIMO Profile soft key. Toggle this key between On and Off . |

LTE - TDD Auto Measurement Signal Performance Test Procedure

MEASURE SETUP



- n **CELL ID:** Enables or disables automatic detection of the Cell ID of the transmitted LTE signal. Manually setting the Cell ID to a specific one can speed up to get synchronization with BTS.
 - Y **AUTO:** Detects the Cell ID automatically.
 - Y **MANUAL:** Sets the Cell ID to a specific one.
- n **ANTENNA PORT:** Sets the antenna port number automatically or manually. Each time this soft key is pressed, selection changes among **Auto**, **0**, and **1**.
- n **BANDWIDTH:** Selects the nominal channel bandwidth to be measured among **1.4 MHz**, **3 MHz**, **5 MHz**, **10 MHz**, **15 MHz**, and **20 MHz**.
- n **EXTERNAL OFFSET:** Sets an external offset value. An offset consists of a cable loss and a user offset and the measurement result shows the value reflecting both offset values. When the external offset value is set at 40 dB in the Spectrum mode, the measurement result compensates 40 dB at both the Spectrum Analyzer and Signal Analyzer modes.
- n **RF PROFILE:** Turns on or off the RF profiling such as Channel Power and Subframe Frequency Error.
- n **MODULATION PROFILE:** Turns on or off the modulation profiling such as P-SS, S-SS, Data - QPSK, Data - 16QAM, and Data - 64QAM.
- n **MIMO PROFILE:** Turns on or off the MIMO profiling such as TX1 - RS0, TX2 - RS1, and Time Alignment Error.

POWER STATISTICS CCDF

Power Statistics Complementary Cumulative Distribution Function (CCDF) measurement

characterizes the power statistics of input signal. It provides PAR (Peak to Average power Ratio) versus different probabilities.

Setting Mode

| Step | Description |
|---|---|
| 1. Connect the cable | Connect a cable directly or indirectly as shown in the section Connecting a Cable on page 8 of this chapter. |
| 2. Set the measurement mode MEASURE [Signal Analyzer] [LTE - TDD] [Power Statistics CCDF] | Press the MEASURE hot key. Press the Signal Analyzer soft key. Press the LTE - TDD soft key. Press the Power Statistics CCDF soft key. |

Setting Frequency

| Step | Description |
|--|---|
| 1. Set the frequency FREQ/DIST [Unit] <Freq> or <Channel> | Press the FREQ/DIST hard key. Press the Unit soft key. Toggle this key between Freq and Channel . A set of Freq/Dist screen menu changes accordingly. |
| <i>When Freq is selected:</i> [Center Frequency] Enter a value [GHz], [MHz], [kHz], or [Hz] | Press the Center Frequency soft key. Use the numeric keys, the rotary knob, or the arrow keys. When using the numeric keys, the input is completed by selecting one of the unit soft keys. |
| <i>When Channel is selected:</i> [Channel Standard] Select a channel standard [Select] or ENTER | Press the Channel Standard soft key. If this channel standard shows its default setting Band Global, go set the channel number directly. Press the arrow keys, rotate the knob, or press the Page Up and Page Down soft keys to highlight a frequency band to select. Press the Select soft key or the ENTER hard key. |
| [Channel Number] Enter a value [Forward] | Press the Channel Number soft key. Use the numeric keys to input value and press the Forward soft key to complete the input. The instrument automatically |

| | |
|--|---|
| | displays its corresponding center frequency value for the channel number. |
|--|---|

FREQ/DIST



- n **UNIT:** Determines the way how to set the frequency band either with standard band or custom frequency band. Toggling this key between **Freq** and **Channel** changes a set of Freq/Dist screen menu automatically. When the **Channel** is selected, the instrument sets the **Channel Standard** setting to **Band Global** as default so that the user can set the **Channel Number** directly without choosing a standard channel band from the list.
- n **CENTER FREQUENCY:** Changes the center frequency setting. Use the rotary knob or the arrow keys. Or use the numeric keys to input a certain value and press one of the unit soft keys to complete the input.
- n **FREQUENCY STEP:** Defines the amount of frequency to be increased or decreased when using the rotary knob or the arrow keys to change the **Center Frequency**. This frequency step size can be entered by using numeric keys and the unit soft keys.
- n **CHANNEL NUMBER:** Enters a channel number. The instrument automatically displays its corresponding center frequency value for the channel number.
- n **CHANNEL STEP:** Defines the amount of channel to be increased or decreased when using the rotary knob or the arrow keys to change the **Channel Number**. This channel step size can be entered by using numeric keys and the **Enter** soft key.
- n **CHANNEL STANDARD:** When the channel standard is selected from the list, the center frequency information on the display screen will be mapped accordingly to the selected channel standard. The channel standards available in the instrument are listed in the Appendix C – Band, Frequency & Channel Standard.

Setting Amplitude

| Step | Description |
|---|--|
| 1. Set the reference/attenuation level AMP/SCALE [Auto Scale] | Press the AMP/SCALE hard key. Press the Auto Scale soft key to automatically set optimum levels of reference and attenuation. |
| or | |
| [Attenuation] | Press the Attenuation soft key. The Auto mode is set by |

| | |
|--|---|
| <p><Manual></p> <p>Enter an attenuation value</p> | <p>default. This key toggles between the Auto and Manual.</p> <p>Press the Attenuation soft key to highlight the Manual mode and change the attenuation value to optimize S/N.</p> <p>Use the numeric keys or the rotary knob that changes in a 5 dB step. The attenuation setting range is 0 to 50 dB.</p> |
|--|---|

AMP/SCALE



- n **AUTO SCALE:** The instrument can automatically set the scale to the minimum and maximum values on the Y-axis of the graph for optimum display of the traces measured. Each time the **Auto Scale** is selected, the top and bottom scales are set to the minimum and maximum values with margin on the Y-axis of the display screen.
- n **ATTENUATION**
 - Y **AUTO:** Input attenuator's value is automatically set depending on the reference level. This is the default operation mode, so it is recommended to use this mode unless a special measurement condition is needed.
 - Y **MANUAL:** Sets the attenuator's value for the **Spectrum Analyzer RF In 50 Ω** port.

Setting Sweep Mode

SWEEP



This hot key is used to set the sweep parameters. The user input window must be inactive first to get the Sweep hot key function other than the number input.

- n **SWEEP MODE:** Sets the sweep method. Toggle between **Continue** and **Single**.

| Step | Description |
|---|---|
| <p>1. Set the sweep mode</p> <p>SWEEP</p> <p>[Sweep Mode]</p> | <p>Press the SWEEP hot key.</p> <p>Press the Sweep Mode soft key. Toggle between Continue and Single.</p> |

Setting Trigger Source

TRIGGER



This hot key is used to select the trigger source among **Internal**, **External**, and **GPS**. The user input

window must be inactive first to get the Trigger hot key function other than the number input.

Setting External Clock

To enhance the reliability of modulation analysis measurements the JD740A series must be synchronized with the Base Station. When an external clock is not supplied, the JD740A series works with a built-in internal high-accuracy time base. In this case, some measurement results may exhibit inaccurate values. Therefore, it is highly recommended to use the same reference clock as signal source. Trigger mode can be changed by using the **TRIGGER** hot key.

EXTERNAL CLOCK OPERATING STANDARDS

| Clock | Type | Reference | Port | Switching Standard |
|--------------------|----------|--------------------|---------------|--|
| External Reference | Internal | Internal 10 MHz | | Default |
| | External | External Ref Clock | Ext Ref (SMA) | Manual switching (Input signal level >-3 dBm) |
| | GPS | GPS Clock | GPS (SMA) | Automatic switching (GPS signal received) |
| Trigger | Internal | Internal Trigger | | Default |
| | External | External Trigger | Trigger (SMA) | Manual switching |
| | GPS | GPS | GPS (SMA) | Manual switching |

CONNECTION

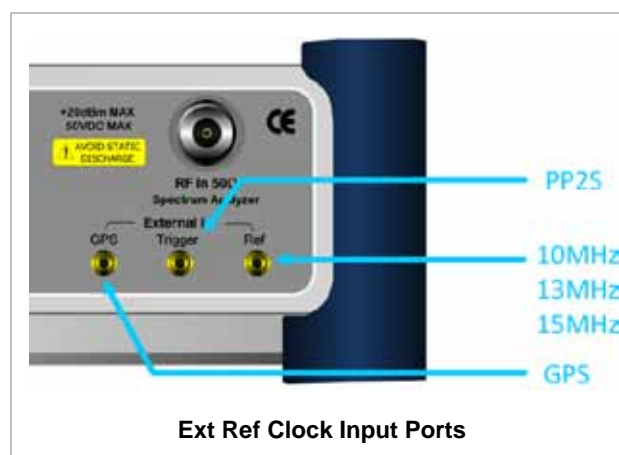

ENABLING EXTERNAL REFERENCE

| Step | Description |
|------|-------------|
|------|-------------|

| | |
|--|---|
| <p>1. Connect an external reference</p> | <p>Connect one of the external references or a GPS antenna to the JD740A series.</p> |
| <p>2. Change reference clock SYSTEM [Frequency Reference] [External 10 MHz], [External 13 MHz], [External 15 MHz] or [GPS]</p> | <p>Press the SYSTEM hot key. Press the Frequency Reference soft key to select one of the external reference clocks or GPS. Press one of the soft keys to choose among External 10 MHz, External 13 MHz, External 15 MHz, and GPS.</p> |

EXTERNAL REFERENCE INDICATOR INFORMATION

Each indicator tells different locking status according to a connection. When a GPS antenna is connected, longitude and latitude information will be displayed on the screen.

| Type | Indicator | Description |
|----------|--|----------------------------------|
| Internal |  (Green) | Locked |
| External |  (Green) | Locked |
| |  (Red) | Unlocked |
| GPS |  (Green) | Locked |
| |  (Yellow) | Locking in progress |
| |  (Gray) | Unable to lock or antenna failed |

Measurement Procedure

| Step | Description |
|---|---|
| <p>1. Set the measurement parameters MEASURE SETUP [CCDF Length] Enter a value [Enter]</p> | <p>Press the MEASURE SETUP hot key. Press the CCDF Length soft key. Use the numeric keys to input value. Press the Enter soft key.</p> |

LTE - TDD Power Statistics CCDF Measurement Procedure

MEASURE SETUP



- n **CCDF LENGTH:** Sets the length of the CCDF which is the number of measurements to be averaged. To change the value, use the numeric keys and press the **Enter** soft key or the **ENTER**

hard key to complete to the input (value range 1 to 100).

Measurement Example

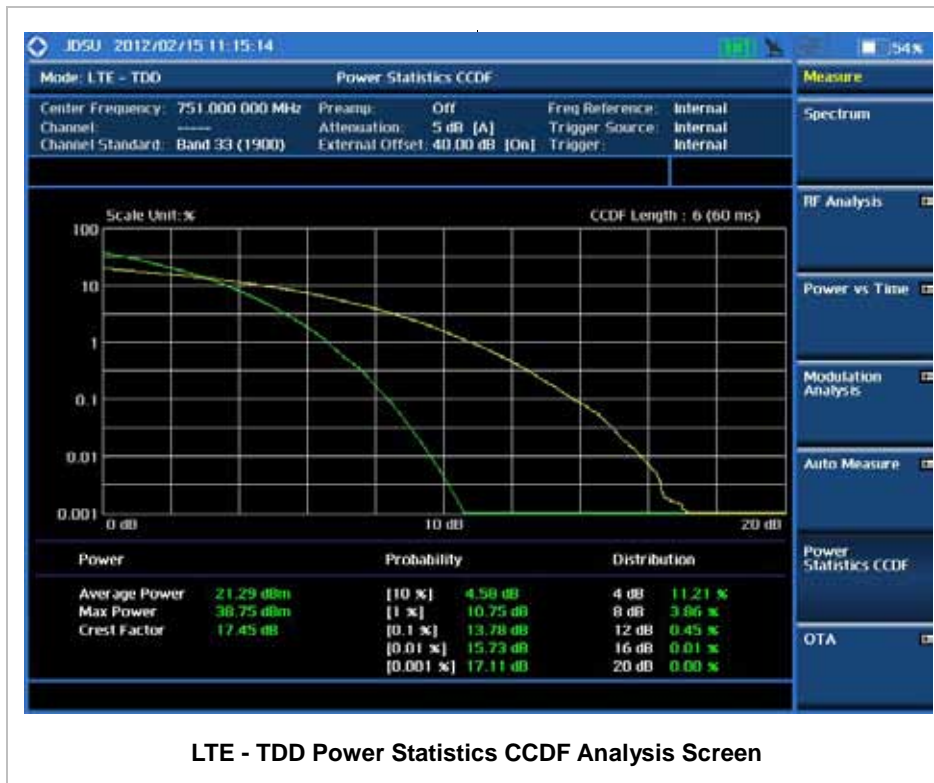

LTE - TDD Power Statistics CCDF Analysis Screen

LTE - TDD OTA MEASUREMENTS

The TDD LTE Over The Air (OTA) measurement has ID Scanner, Multipath Profile, Datagram, and Control Channel screens. ID Scanner displays key parameters such as RSRP, RSRQ, RS-SINR and S-SS RSSI. Multipath Profile enables the user to determine RF environmental conditions of testing area. Control Channel provides summary of all control channels including RS power variation over time.

TDD LTE OTA Measurements provide the following essential measurements.

- n ID Scanner
- n Multipath Profile
- n Control Channel
- n Datagram

n Route Map

Setting Mode

Connecting a GPS antenna with the instrument is a mandatory for the OTA measurements.

| Step | Description |
|--|---|
| 1. Connect the antenna | Connect antennas as shown in the Connecting a Cable on page 9 of this chapter. |
| 2. Select the mode MODE [Signal Analyzer] [LTE - TDD] [OTA] [ID Scanner], [Multipath Profile], [Datagram], [Control Channel], or [Route Map] | Press the MODE hard key. Press the Signal Analyzer soft key. Press the LTE - TDD soft key. Press the OTA soft key. Press one of the measurement mode soft keys to select. |

Setting Frequency

| Step | Description |
|---|--|
| 1. Set the frequency FREQ/DIST [Unit] <Freq> or <Channel> <i>When Freq is selected:</i> [Center Frequency] Enter a value [GHz], [MHz], [kHz], or [Hz] <i>When Channel is selected:</i> [Channel Standard] Select a channel standard | Press the FREQ/DIST hard key. Press the Unit soft key. Toggle this key between Freq and Channel . A set of Freq/Dist screen menu changes accordingly. Press the Center Frequency soft key. Use the numeric keys, the rotary knob, or the arrow keys. When using the numeric keys, the input is completed by selecting one of the unit soft keys. Press the Channel Standard soft key. If this channel standard shows its default setting Band Global, go set the channel number directly. Press the arrow keys, rotate the knob, or press the Page Up and Page Down soft keys to highlight a frequency band to |

| | |
|---|--|
| <p>[Select] or ENTER</p> | <p>select. Press the Select soft key or the ENTER hard key.</p> |
| <p>[Channel Number] Enter a value [Forward]</p> | <p>Press the Channel Number soft key. Use the numeric keys to input value and press the Forward soft key to complete the input. The instrument automatically displays its corresponding center frequency value for the channel number.</p> |

FREQ/DIST



- n **UNIT:** Determines the way how to set the frequency band either with standard band or custom frequency band. Toggling this key between **Freq** and **Channel** changes a set of Freq/Dist screen menu automatically. When the **Channel** is selected, the instrument sets the **Channel Standard** setting to **Band Global** as default so that the user can set the **Channel Number** directly without choosing a standard channel band from the list.
- n **CENTER FREQUENCY:** Changes the center frequency setting. Use the rotary knob or the arrow keys. Or use the numeric keys to input a certain value and press one of the unit soft keys to complete the input.
- n **FREQUENCY STEP:** Defines the amount of frequency to be increased or decreased when using the rotary knob or the arrow keys to change the **Center Frequency**. This frequency step size can be entered by using numeric keys and the unit soft keys.
- n **CHANNEL NUMBER:** Enters a channel number. The instrument automatically displays its corresponding center frequency value for the channel number.
- n **CHANNEL STEP:** Defines the amount of channel to be increased or decreased when using the rotary knob or the arrow keys to change the **Channel Number**. This channel step size can be entered by using numeric keys and the **Enter** soft key.
- n **CHANNEL STANDARD:** When the channel standard is selected from the list, the center frequency information on the display screen will be mapped accordingly to the selected channel standard. The channel standards available in the instrument are listed in the Appendix C – Band, Frequency & Channel Standard.

Setting Amplitude

| Step | Description |
|--|---|
| <p>1. Set the reference/attenuation level AMP/SCALE [Auto Scale]</p> | <p>Press the AMP/SCALE hard key. Press the Auto Scale soft key to automatically set optimum</p> |

| | |
|---|---|
| <p>or</p> <p>[Reference Level] Enter a reference level value</p> <p>[dBm] or ENTER</p> <p>[Attenuation]</p> <p><Manual></p> <p>Enter an attenuation value</p> | <p>levels of reference and attenuation.</p> <p>Press the Reference Level soft key to set manually. Use the numeric keys or the rotary knob that changes in a 10 dB step.</p> <p>Press the dBm soft key or the ENTER hard key.</p> <p>Press the Attenuation soft key. The Auto mode is set by default. This key toggles between the Auto and Manual.</p> <p>Press the Attenuation soft key to highlight the Manual mode and change the attenuation value to optimize S/N. Use the numeric keys or the rotary knob that changes in a 5 dB step. The attenuation setting range is 0 to 50 dB.</p> |
|---|---|

AMP/SCALE



- n **AUTO SCALE:** The instrument can automatically set the scale to the minimum and maximum values on the Y-axis of the graph for optimum display of the traces measured. Each time the **Auto Scale** is selected, the top and bottom scales are set to the minimum and maximum values with margin on the Y-axis of the display screen.
- n **REFERENCE LEVEL:** Sets the maximum Y-axis range. *This key is used in the OTA Control Channel mode and the Route Map mode.*
- n **ATTENUATION**
 - Y **AUTO:** Input attenuator's value is automatically set depending on the reference level. This is the default operation mode, so it is recommended to use this mode unless a special measurement condition is needed.
 - Y **MANUAL:** Sets the attenuator's value for the **Spectrum Analyzer RF In 50 Ω** port.
- n **PREAMP:** Turns on or off the internal pre-amplifier. Preamp results in a correction being applied to compensate for the gain of the preamp so that amplitude readings show the value at the input connector. This soft key toggles between the **On** and **Off**. When it is set to On, the allowable attenuation input range is from 0 dB to 10 dB in a multiple of 5. If the attenuation value is manually set greater than 10 dB, the instrument will automatically turn off the pre-amplifier to display low level signal properly on the screen.
- n **EXTERNAL OFFSET:** Sets an external offset value. An offset consists of a cable loss and a user offset and the measurement result shows the value reflecting both offset values. When the external offset value is set at 40 dB in the Spectrum mode, the measurement result compensates 40 dB at both the Spectrum Analyzer and Signal Analyzer modes.

Setting Sweep Mode

SWEEP



This hot key is used to set the sweep parameters. The user input window must be inactive first to get the Sweep hot key function other than the number input.

- n **SWEEP MODE:** Sets the sweep method. Toggle between **Continue** and **Single**.

| Step | Description |
|--|---|
| 1. Set the sweep mode SWEEP [Sweep Mode] | Press the SWEEP hot key. Press the Sweep Mode soft key. Toggle between Continue and Single . |

Setting Trigger Source

TRIGGER



This hot key is used to select the trigger source among **Internal**, **External**, and **GPS**. The user input window must be inactive first to get the Trigger hot key function other than the number input. For OTA measurement, a GPS antenna should be connected and the trigger source should be set to **GPS**.

Setting External Clock

To enhance the reliability of modulation analysis measurements the JD740A series must be synchronized with the Base Station. When an external clock is not supplied, the JD740A series works with a built-in internal high-accuracy time base. In this case, some measurement results may exhibit inaccurate values. Therefore, it is highly recommended to use the same reference clock as signal source. Trigger mode can be changed by using the **TRIGGER** hot key.

EXTERNAL CLOCK OPERATING STANDARDS

| Clock | Type | Reference | Port | Switching Standard |
|--------------------|----------|--------------------|---------------|--|
| External Reference | Internal | Internal 10 MHz | | Default |
| | External | External Ref Clock | Ext Ref (SMA) | Manual switching (Input signal level >-3 dBm) |
| | GPS | GPS Clock | GPS (SMA) | Automatic switching (GPS signal received) |
| Trigger | Internal | Internal Trigger | | Default |

| | | | | |
|--|----------|------------------|---------------|------------------|
| | External | External Trigger | Trigger (SMA) | Manual switching |
| | GPS | GPS | GPS (SMA) | Manual switching |

CONNECTION

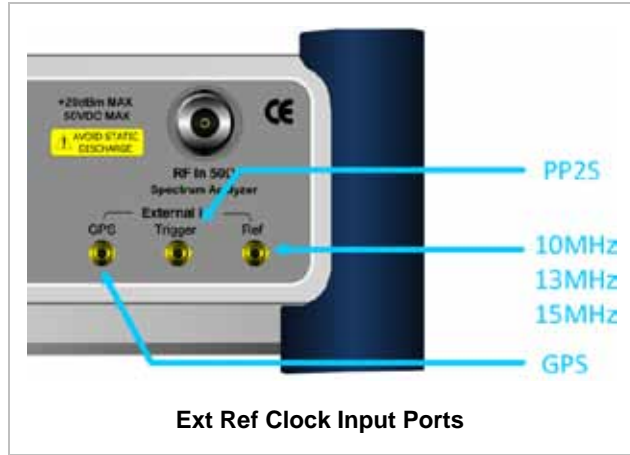

ENABLING GPS EXTERNAL REFERENCE

| Step | Description |
|--|--|
| 1. Connect a GPS antenna | Connect a GPS antenna to the JD740A series. |
| 2. Change reference clock SYSTEM [Frequency Reference] [GPS] | Press the SYSTEM hot key. Press the Frequency Reference soft key. Press the GPS soft key to perform OTA measurements. |

GPS EXTERNAL REFERENCE INDICATOR INFORMATION

When a GPS antenna is connected, the instrument automatically detects it. Each indicator tells different locking status depending on its connection. If it is successfully locked, the instrument will display "GPS" and longitude and latitude information on the screen. If it is unlocked or the antenna is disconnected, the display will be automatically switched to "Internal".

| Type | Indicator | Description |
|------|-----------|----------------------------------|
| GPS | (Green) | Locked |
| | (Yellow) | Locking in progress |
| | (Gray) | Unable to lock or antenna failed |

LTE - TDD OTA ID SCANNER

The LTE mobile receives signals from multiple base stations that all of these signals share the same spectrum and are present at the same time. Each base station has unique scrambling code assigned to the particular base station and it differentiates its signal from other base stations in the area.

The OTA ID Scanner shows key parameters such as RSRP (Reference Signal Received Power) and RSRQ (Reference Signal Received Quality) that predict quickly the downlink coverage.

- n RSRPs from entire cells help to rank between the different cells as input for handover and cell reselection decisions.
- n RSRQ provides additional information when RSPR is not sufficient to make a reliable handover or cell reselection decision.

All of the parameters for OTA ID scanner can be potted on a Google map and earth by using JDViewer.

Measurement Procedure

| Step | Description |
|--|--|
| 1. Set the measurement mode MEASURE [OTA] [ID Scanner] | Press the MEASURE hot key. Press the OTA soft key. Press the ID Scanner soft key. |
| 2. Set the measurement parameters MEASURE SETUP [Bandwidth] [1.4 MHz], [3 MHz], [5 MHz], [10 MHz], [15 MHz], or [20 MHz] [Auto Save] <On> or <Off> | Press the MEASURE SETUP hot key. Press the Bandwidth soft key. Press one of the soft keys to select. Press the Auto Save soft key. Toggle between On and Off . |

LTE - TDD OTA ID Scanner Measurement Procedure

MEASURE SETUP



- n **AUTO SAVE:** Enables or disables automatic saving of the measurement data to an external USB memory. When it turns on, the measurements will be recorded into the default file (logging.ota) or a user-named file.
- n **BANDWIDTH:** Selects the nominal channel bandwidth to be measured among **1.4 MHz, 3 MHz, 5 MHz, 10 MHz, 15 MHz,** and **20 MHz.**
- n **MISCELLANEOUS**
 - Y **CYCLIC PREFIX:** Sets the cyclic prefix to **Normal** or **Extended**. For OFDM parameter details by different bandwidth, refer to the table in the Appendix E – Cyclic Prefix Table.

Measurement Example

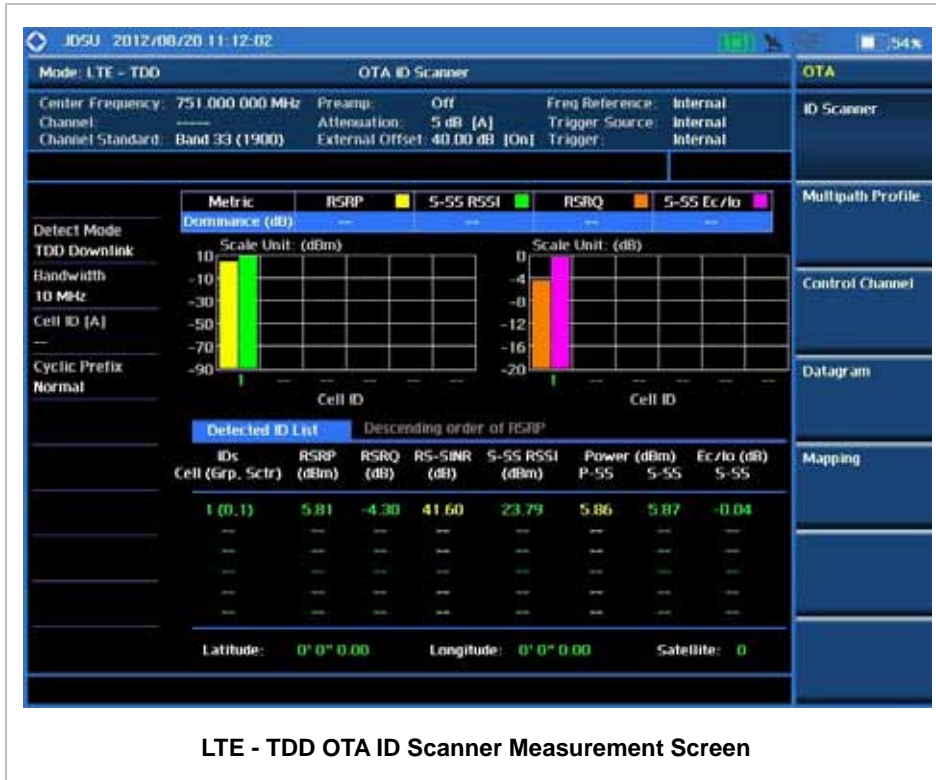

LTE - TDD OTA ID Scanner Measurement Screen

LTE - TDD OTA MULTIPATH PROFILE

The Multipath Profile enables the user to determine RF environmental conditions of testing area. It indicates the amount of power of the dominant pilot signal that is dispersed outside the main correlation peak due to multipath echoes that are expressed in dB. This value should be very small ideally.

The multipath profile is the result of portions of the original broadcast signal arriving at the receiving antenna out of phase. This can be caused by the signal being reflected off objects such as buildings, or being refracted through the atmosphere differently from the main signal.

Measurement Procedure

| Step | Description |
|---|---|
| 1. Set the measurement mode MEASURE [OTA] | Press the MEASURE hot key. Press the OTA soft key. |

| | |
|--|--|
| <p>[Multipath Profile]</p> | <p>Press the Multipath Profile soft key.</p> |
| <p>2. Set the measurement parameters</p> <p>MEASURE SETUP</p> <p>[Bandwidth] [1.4 MHz], [3 MHz], [5 MHz], [10 MHz], [15 MHz], or [20 MHz]</p> <p>[Display] <RS> or <Sync></p> <p>[RS Window] [2 us], [4 us], or [8 us]</p> | <p>Press the MEASURE SETUP hot key.</p> <p>Press the Bandwidth soft key.</p> <p>Press one of the soft keys to select.</p> <p>Press the Display soft key to select its display mode.</p> <p>Toggle this key between RS and Sync.</p> <p>Press the RS Window soft key if the RS is set.</p> <p>Press one of the RS Window soft keys to choose.</p> |

LTE - TDD OTA Multipath Profile Measurement Procedure

MEASURE SETUP 

- n **BANDWIDTH:** Selects the nominal channel bandwidth to be measured among **1.4 MHz, 3 MHz, 5 MHz, 10 MHz, 15 MHz, and 20 MHz**.
- n **DISPLAY:** Sets the display mode to **RS** or **Sync**.
- n **RS WINDOW:** Selects the RS Window options among **2 us, 4 us, and 8 us**. This soft key is activated to be set only when the RS is selected for the display mode.
- n **MISCELLANEOUS**
 - Y **CYCLIC PREFIX:** Sets the cyclic prefix to **Normal** or **Extended**. For OFDM parameter details by different bandwidth, refer to the table in the Appendix E – Cyclic Prefix Table.

Measurement Example

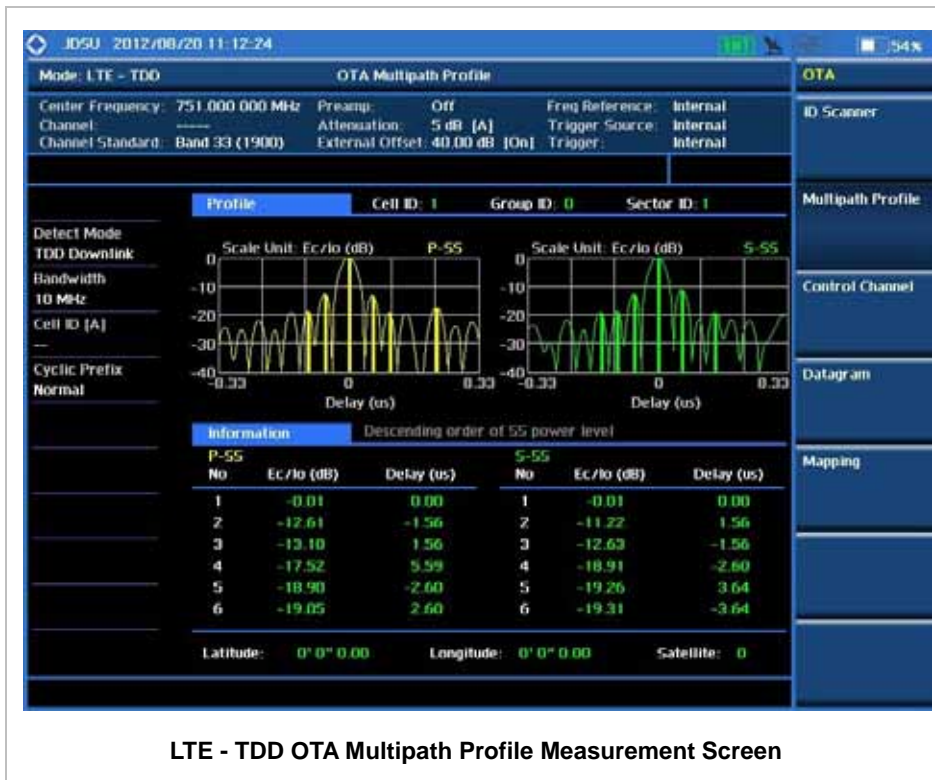

LTE - TDD OTA Multipath Profile Measurement Screen

LTE - TDD OTA CONTROL CHANNEL

DL RS power is the resource element power of Downlink Reference Symbol. The absolute DL RS power is indicated on the BCH. The absolute accuracy is defined as the maximum deviation between the DL RS power indicated on the BCH and the DL RS power at the BS antenna connector.

OTA Control Channel provides summary of all control channels including RS power trend over time. Positioning information, latitude and longitude will be displayed if a GPS antenna is supplied and locked to the GPS satellites on the bottom of the screen.

Measurement Procedure

| Step | Description |
|---|---|
| 1. Set the measurement mode MEASURE [OTA] [Control Channel] | Press the MEASURE hot key. Press the OTA soft key. Press the Control Channel soft key. |
| 2. Set the measurement parameters MEASURE SETUP | Press the MEASURE SETUP hot key. |

| | |
|--|--|
| <p>[Bandwidth] [1.4 MHz], [3 MHz], [5 MHz], [10 MHz], [15 MHz], or [20 MHz]</p> | <p>Press the Bandwidth soft key. Press one of the soft keys to select.</p> |
| <p>[Cell ID] <Auto> or <Manual> Enter a value [Enter]</p> | <p>Press the Cell ID soft key. Toggle between Auto and Manual. Use the numeric keys to set the Cell ID manually. Press the Enter soft key.</p> |
| <p>[Subframe No] Enter a value [Enter]</p> | <p>Press the Subframe No soft key. Use the numeric keys to input value. Press the Enter soft key to complete the input.</p> |
| <p>[Auto Save] <On> or <Off></p> | <p>Press the Auto Save soft key. Toggle between On and Off.</p> |

LTE - TDD OTA Control Channel Measurement Procedure

MEASURE SETUP



- n **AUTO SAVE:** Enables or disables automatic saving of the measurement data to an external USB memory. When it turns on, the measurements will be recorded into the default file (logging.ota) or a user-named file.
- n **BANDWIDTH:** Selects the nominal channel bandwidth to be measured among **1.4 MHz, 3 MHz, 5 MHz, 10 MHz, 15 MHz, and 20 MHz**.
- n **CELL ID:** Enables or disables automatic detection of the Cell ID of the transmitted LTE signal. Manually setting the Cell ID to a specific one can speed up to get synchronization with BTS.
 - Y **AUTO:** Detects the Cell ID automatically.
 - Y **MANUAL:** Sets the Cell ID to a specific one.
- n **SUBFRAME NO:** Sets the subframe number to be measured.
- n **MISCELLANEOUS**
 - Y **ANTENNA PORT:** Sets the antenna port number automatically or manually. Each time this soft key is pressed, selection changes among **Auto, 0, and 1**.
 - Y **CYCLIC PREFIX:** Sets the cyclic prefix to **Normal** or **Extended**. For OFDM parameter details by different bandwidth, refer to the table in the Appendix E – Cyclic Prefix Table.

Measurement Example



LTE - TDD OTA Control Channel Analysis Screen

LTE - TDD OTA DATAGRAM

The OTA Datagram is a time-varying spectral representation that shows how the power of a signal varies with time. The power allocated to the specific resource block will be represented with an amplitude axis (in dBm) and the waterfall diagram will show the trend of past resource block power over certain period of time. Using a marker function facilitates analysis of accumulated resource block power for data utilization.

Measurement Procedure

| Step | Description |
|--|--|
| 1. Set the measurement mode MEASURE [OTA] [Datagram] | Press the MEASURE hot key. Press the OTA soft key. Press the Datagram soft key. |
| 2. Set the measurement parameters MEASURE SETUP [Bandwidth] [1.4 MHz], [3 MHz], [5 MHz], | Press the MEASURE SETUP hot key. Press the Bandwidth soft key. Press one of the soft keys to select. |

| | |
|---|--|
| <p>[10 MHz], [15 MHz], or [20 MHz]</p> <p>[Subframe No] Enter a value [Enter]</p> <p>[PDSCH Threshold] Enter a value [dB] or ENTER</p> <p>[Cell ID] <Auto> or <Manual> Enter a value [Enter]</p> <p>[Auto Save] <On> or <Off></p> | <p>Press the Subframe No soft key. Use the numeric keys to input value. Press the Enter soft key to complete the input.</p> <p>Press the PDSCH Threshold soft key. Use the numeric keys to input value. Press the unit soft key or the ENTER hard key to complete the input.</p> <p>Press the Cell ID soft key. Toggle between Auto and Manual. Use the numeric keys to set the Cell ID manually. Press the Enter soft key.</p> <p>Press the Auto Save soft key. Toggle between On and Off.</p> |
| <p>3. Analyze the measurement result</p> <p>[Time Cursor] <On> or <Off></p> | <p>Press the Time Cursor soft key. Toggle between On and Off.</p> |

LTE - TDD OTA Datagram Measurement Procedure

MEASURE SETUP



- n **RESET/RESTART:** Restarts the measurement.
- n **AUTO SAVE:** Enables or disables automatic saving of the measurement data to an external USB memory. When it turns on, the measurements will be recorded into the default file (logging.ota) or a user-named file.
- n **TIME CURSOR:** Enables or disables the time cursor indicator. When the time cursor is enabled after specifying a number, measurement is put on hold and information of the specific number is updated on the measurement screen.
- n **BANDWIDTH:** Selects the nominal channel bandwidth to be measured among **1.4 MHz, 3 MHz, 5 MHz, 10 MHz, 15 MHz, and 20 MHz**.
- n **SUBFRAME NO:** Sets the subframe number to be measured.
- n **PDSCH THRESHOLD:** Sets the PDSCH threshold.
- n **CELL ID:** Enables or disables automatic detection of the Cell ID of the transmitted LTE signal. Manually setting the Cell ID to a specific one can speed up to get synchronization with BTS.

- Y **AUTO:** Detects the Cell ID automatically.
 - Y **MANUAL:** Sets the Cell ID to a specific one.
- n **MISCELLANEOUS**
- Y **CYCLIC PREFIX:** Sets the cyclic prefix to **Normal** or **Extended**. For OFDM parameter details by different bandwidth, refer to the table in the Appendix E – Cyclic Prefix Table.

Measurement Example

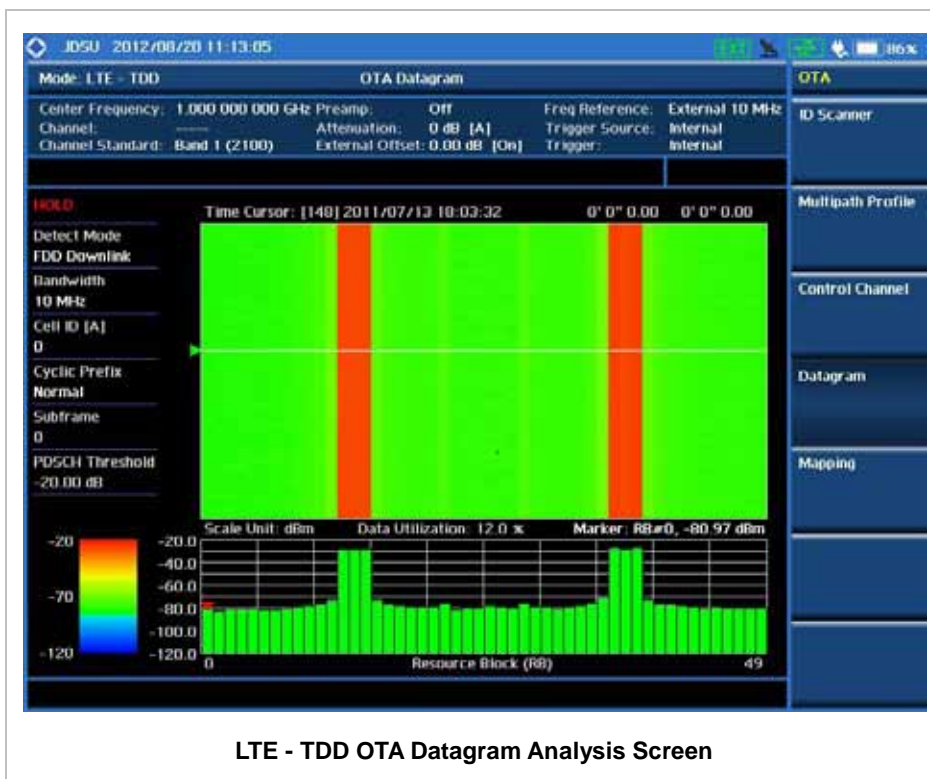

LTE - TDD ROUTE MAP

The JD740A Series provides indoor and outdoor mapping function that allows a user to collect data of points in an indoor or outdoor environment and track the received signals and coverage of RF transmitters plotting real time directly on top of a loaded floor plan or a map.

Measurement Procedure

| Step | Description |
|--|--|
| 1. Set the measurement mode MEASURE [OTA] [Route Map] | Press the MEASURE hot key. Press the OTA soft key. Press the Route Map soft key. |
| 2. Set the measurement parameters MEASURE SETUP [Load Map] [Plot Point] [Position] or [GPS] [Plot Item] [RSRP], [RSRQ], [RS-SINR], [S-SS RSSI], [P-SS Power], [S-SS Power], or [S-SS Ec/Io] [Screen Mode] <Map> or <Full> [Bandwidth] [1.4 MHz], [3 MHz], [5 MHz], [10 MHz], [15 MHz], or [20 MHz] [Plot] <Start> or <Stop> | Press the MEASURE SETUP hot key. After plugging in a USB drive, press the Load Map soft key to load a map file created in JDMaPCreator and copied into the USB drive. Press the Plot Point soft key to get option menu. Press the Position soft key without a GPS antenna or the GPS with one. Selecting GPS activates the Screen Mode soft key to be set. Press the Plot Item soft key. Select one of the plot item soft keys as needed. Press the Screen Mode soft key. Toggle this key between Map and Full . Press the Bandwidth soft key. Press one of the soft keys to select. Press the Plot soft key to start or stop plotting. Toggle this key between Start and Stop . |

MEASURE SETUP



Sets the measurement parameters for the Route Map. The legend displayed in different colors at the bottom of the screen can be set with the **Limit** hot key.

- n **PLOT:** Starts or stops a measurement in order to plot received signals or collected data on top of a loaded map. Toggle this key between **Start** and **Stop**. The instrument does not automatically save collected data. After stopping the current route mapping, the user needs to save the result with the **Save** hot key for later use. If not, all the collected data for the route will be lost.
- n **PLOT POINT:** Selects a method of plotting points.

- Y **POSITION:** Measures data without GPS in an indoor environment. After starting to plot, press the **Enter** hard key or the center of the rotary knob as you move with the instrument. Each time the user presses the key or the knob, the instrument plots a point on top of the loaded map. Use the arrow keys to change direction of route and the rotary knob to change distance. If the instrument has the screen with touch screen, directly touch the screen in order to collect data.
- Y **GPS:** Automatically collects data with GPS in an outdoor environment and plots points as the user moves in a vehicle.
- n **PLOT ITEM:** Selects a plot item among RSRP, RSRQ, RS-SINR, S-SS RSSI, P-SS Power, S-SS Power, or S-SS Ec/Io. The instrument collects the strongest Cell ID data to plot points.
- n **SCREEN MODE:** Selects either **Map** or **Full**, depending on how to show collected points on the screen. Selecting GPS for the Plot Point activates this key. Numbers shown next to the points represent their Cell IDs. The instrument displays Cell ID of the start point and those of the points with different Cell IDs from the right previous ones.
- Y **MAP:** Displays collected points only that can be seen within the boundary of the loaded map. If a point is off the map, the instrument displays an arrow indicating the direction of the current location on the map and the distance from the center to the location at the top of the screen.
- Y **FULL:** Displays all the points measured for route on the screen without the map.
- n **LOAD MAP:** Loads a floor plan or a map file created in **JDMapCreator**. The JDMapCreator converts and resizes any scanned floor plan or layout so that it can be loaded and fit to the instrument display.
- n **BANDWIDTH:** Selects the nominal channel bandwidth to be measured among **1.4 MHz, 3 MHz, 5 MHz, 10 MHz, 15 MHz, and 20 MHz**.

Setting Limit



This hot key is used to set threshold values for the legend displayed on the screen. The different colors of the legend indicate the quality of the measured data depending on their threshold setting. The user input window must be inactive first to get the Limit hot key function other than the number input.

| Step | Description |
|---|---|
| 1. Set the limit Limit [RSRP] | Press the LIMIT hot key. Press the RSRP soft key to set its threshold. |

| | |
|---|--|
| [Excellent] Enter a value [Enter] | Press the Excellent soft key. Use the rotary knob or the numeric keys. |
| [Very Good] Enter a value [Enter] | Press the Very Good soft key. Use the rotary knob or the numeric keys. |
| [Good] Enter a value [Enter] | Press the Good soft key. Use the rotary knob or the numeric keys. |
| [Fair] Enter a value [Enter] | Press the Fair soft key. Use the rotary knob or the numeric keys. |
| [Poor] Enter a value [Enter] | Press the Poor soft key. Use the rotary knob or the numeric keys. |
| [RSRQ] | Press the RSRQ soft key to set its threshold. |
| [Good] Enter a value [Enter] | Press the Good soft key. Use the rotary knob or the numeric keys. |
| [Fair] Enter a value [Enter] | Press the Fair soft key. Use the rotary knob or the numeric keys. |
| [Poor] Enter a value [Enter] | Press the Poor soft key. Use the rotary knob or the numeric keys. |
| [RS-SINR] | Press the RS-SINR soft key to set its threshold. |
| [Good] Enter a value [Enter] | Press the Good soft key. Use the rotary knob or the numeric keys. |
| [Fair] Enter a value [Enter] | Press the Fair soft key. Use the rotary knob or the numeric keys. |
| [Poor] Enter a value [Enter] | Press the Poor soft key. Use the rotary knob or the numeric keys. |
| [S-SS RSSI] | Press the S-SS RSSI soft key to set its threshold. |
| [Excellent] Enter a value [Enter] | Press the Excellent soft key. Use the rotary knob or the numeric keys. |
| [Very Good] Enter a value | Press the Very Good soft key. Use the rotary knob or the numeric keys. |

| | |
|-------------------------------------|--|
| [Enter] | Press the Enter soft key. |
| [Good] Enter a value | Press the Good soft key. Use the rotary knob or the numeric keys. |
| [Enter] | Press the Enter soft key. |
| [Fair] Enter a value | Press the Fair soft key. Use the rotary knob or the numeric keys. |
| [Enter] | Press the Enter soft key. |
| [Poor] Enter a value | Press the Poor soft key. Use the rotary knob or the numeric keys. |
| [Enter] | Press the Enter soft key. |
| [P-SS Power] | Press the P-SS Power soft key to set its threshold. |
| [Excellent] Enter a value | Press the Excellent soft key. Use the rotary knob or the numeric keys. |
| [Enter] | Press the Enter soft key. |
| [Very Good] Enter a value | Press the Very Good soft key. Use the rotary knob or the numeric keys. |
| [Enter] | Press the Enter soft key. |
| [Good] Enter a value | Press the Good soft key. Use the rotary knob or the numeric keys. |
| [Enter] | Press the Enter soft key. |
| [Fair] Enter a value | Press the Fair soft key. Use the rotary knob or the numeric keys. |
| [Enter] | Press the Enter soft key. |
| [Poor] Enter a value | Press the Poor soft key. Use the rotary knob or the numeric keys. |
| [Enter] | Press the Enter soft key. |
| [S-SS Power] | Press the S-SS Power soft key to set its threshold. |
| [Excellent] Enter a value | Press the Excellent soft key. Use the rotary knob or the numeric keys. |
| [Enter] | Press the Enter soft key. |
| [Very Good] Enter a value | Press the Very Good soft key. Use the rotary knob or the numeric keys. |
| [Enter] | Press the Enter soft key. |
| [Good] Enter a value | Press the Good soft key. Use the rotary knob or the numeric keys. |
| [Enter] | Press the Enter soft key. |
| [Fair] Enter a value | Press the Fair soft key. Use the rotary knob or the numeric keys. |
| [Enter] | Press the Enter soft key. |
| [Poor] Enter a value | Press the Poor soft key. Use the rotary knob or the numeric keys. |
| [Enter] | Press the Enter soft key. |

| | |
|--|---|
| <p>[S-SS Ec/Io]</p> <p>[Good]</p> <p>Enter a value</p> <p>[Enter]</p> <p>[Fair]</p> <p>Enter a value</p> <p>[Enter]</p> <p>[Poor]</p> <p>Enter a value</p> <p>[Enter]</p> | <p>Press the RS-SINR soft key to set its threshold.</p> <p>Press the Good soft key.</p> <p>Use the rotary knob or the numeric keys.</p> <p>Press the Enter soft key.</p> <p>Press the Fair soft key.</p> <p>Use the rotary knob or the numeric keys.</p> <p>Press the Enter soft key.</p> <p>Press the Poor soft key.</p> <p>Use the rotary knob or the numeric keys.</p> <p>Press the Enter soft key.</p> |
|--|---|

Measurement Example



Route Map Measurement Screen (Map View)

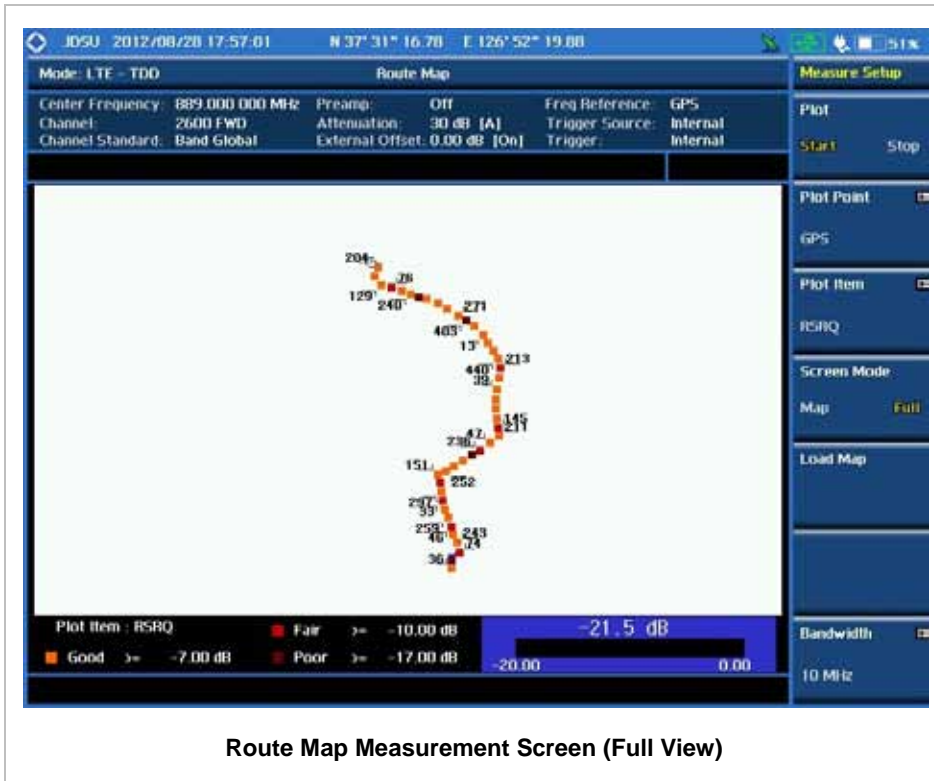

Route Map Measurement Screen (Full View)

ANALYSIS

Using Marker

MARKER



Marker is used to get the information about a specific trace. Six markers can be set on the display and each marker can be used independently. The X and Y coordinates of the trace are displayed when the marker is placed on any position of the trace. The position displaying the marker's X and Y coordinates may be slightly different for each measurement mode and refer to the description of each measurement. There are three different marker types available: Normal, Delta, and Delta pair. Marker position can be set manually by entering numeric values (frequency) when one of the marker types is selected.

- n **SELECT MARKER:** Selects an active marker whose position can be changed with the rotary knob or the arrow keys. The assigned number of the active marker is displayed in the **Select Marker** menu box and the active marker number is also displayed right next to the active marker on the trace when the **Marker View** is set to **On**.
- n **MARKER VIEW:** Displays the selected marker on the screen or hides it. When the **Marker View**

is turned off and then on again in the same measurement mode, markers appear at the previous positions. If a measurement mode is changed, markers are not restored to their previous positions.

- n **NORMAL:** This Normal marker type provides the reading of a marker position on the trace along with the marker number between 1 and 6.
- n **DELTA:** This Delta marker type is associated with a Normal marker. A Normal marker must be set before a Delta marker is set. When the Delta marker is set, the position set by the Delta marker becomes the reference position of the Normal marker and the marker's X and Y values displays the difference compared with the Delta marker.
- n **DELTA PAIR:** This Delta Pair marker type is associated with a Normal marker. A Normal marker must be set before a Delta Pair marker is set. When the Delta Pair marker is set, the position set by the Delta Pair marker becomes the reference position of the Normal marker and the marker's X and Y values displays the difference compared with the Delta Pair marker. The reference position will be varied in accordance with trace change.
- n **MARKER ALL OFF:** Turns all the markers the screen off. When the Marker View is selected for those markers, the instrument displays those markers back at the previous position. If a measurement mode is changed, current settings are not restored.
- n **MARKER \rightarrow :** Sets the X coordinate of the active marker as selected.
 - Y **MARKER \rightarrow CENTER:** Sets the frequency of the active marker to the center frequency of spectrum analyzer.
 - Y **MARKER \rightarrow START:** Sets the frequency of the active marker to the start frequency of spectrum analyzer.
 - Y **MARKER \rightarrow STOP:** Sets the frequency of the active marker to the stop frequency of spectrum analyzer.

Using Peak Search

PEAK SEARCH



Each time the Peak Search soft key is pressed, the active marker is positioned at the highest peak of the trace.

- n **PEAK SEARCH:** Moves the active marker to the highest peak of the trace.
- n **NEXT PEAK:** Moves the active marker to the second highest peak of the trace.
- n **NEXT PEAK RIGHT:** Moves the active marker to the highest peak to the right of its current position.
- n **NEXT PEAK LEFT:** Moves the active marker to the highest peak to the left of its current position.

- n **MIN SEARCH:** Moves the active marker to the lowest peak of the trace.
- n **ALWAYS PEAK:** When the **Always Peak** is set to On, the instrument moves the active marker automatically to the highest peak of the trace every time the trace is refreshed.

Appendix

In this Chapter

| | |
|---|----|
| Appendix A – Product General Information | 2 |
| Appendix B – Cable List | 4 |
| Appendix C – Band, Frequency & Channel Standard | 5 |
| Appendix D – VSWR-Return Loss Conversion Table | 8 |
| Appendix E – Cyclic Prefix Table | 9 |
| Appendix F – Motorola CDMA/EV-DO LMF | 10 |
| JD740A Series LMF Interface | 10 |
| LMF Test Setup | 10 |
| LMF Test Procedure | 11 |
| Appendix G – Ordering Information | 13 |
| JD745A Base Station Analyzer | 13 |
| JD746A RF Analyzer | 14 |
| JD748A Signal Analyzer | 15 |
| JD740A Series Common Options | 16 |

(Rev. 6.0)

APPENDIX A – PRODUCT GENERAL INFORMATION

| | JD745A/JD746A | JD748A | Supplemental Information |
|---------------------------|-------------------------|-------------------------|---------------------------------------|
| Inputs and Outputs | | | |
| RF In | | | Spectrum Analyzer |
| Connector: | Type-N female | Type-N female | |
| Impedance: | 50 Ω | 50 Ω | Nominal |
| Damage Level: | > +40 dBm, >±50 VDC | > +40 dBm, >±50 VDC | Nominal |
| Reflection/RF Out | | N/A | Cable and Antenna Analyzer |
| Connector: | Type-N female | N/A | |
| Impedance: | 50 Ω | N/A | Nominal |
| Damage Level: | > +37 dBm, > ±50 VDC | N/A | Nominal |
| RF In | | N/A | Cable and Antenna Analyzer |
| Connector: | Type-N female | N/A | |
| Impedance: | 50 Ω | N/A | Nominal |
| Damage Level: | > +25 dBm, > ±50 VDC | N/A | Nominal |
| External Trigger, GPS | | | |
| Connector: | SMA female | SMA female | |
| Impedance: | 50 Ω | 50 Ω | Nominal |
| External Ref | | | |
| Connector: | SMA female | SMA female | |
| Impedance: | 50 Ω | 50 Ω | Nominal |
| Input Frequency: | 10, 13, 15 MHz | 10, 13, 15 MHz | |
| Input Range: | -5 to +5 dBm | -5 to +5 dBm | |
| USB | | | |
| USB Host: | Type A, 1 port | Type A, 1 port | Connects flash drive and power sensor |
| USB Client: | Type B, 1 port | Type B, 1 port | Connects to PC for data transfer |
| LAN: | RJ45, 10/100 Base-T | RJ45, 10/100 Base-T | Connects to PC for data transfer |
| E1/T1: | RJ45 | N/A | Available in JD745A |
| GPIO: | N/A | RJ45 | Available in JD746A and JD748A |
| Audio Jack: | 3.5 mm headphone jack | 3.5 mm headphone jack | |
| External Power: | 5.5 mm barrel connector | 5.5 mm barrel connector | |
| Speaker: | Built-in speaker | Built-in speaker | |

| | JD745A/JD746A | JD748A | Supplemental Information |
|--------------------------|---|---|--|
| Display | | | |
| Size: | 8 inch, LED backlight | 8 inch, LED backlight | |
| Resolution: | 800 x 600 | 800 x 600 | |
| Power | | | |
| External DC Input: | 12 to 19 VDC | 12 to 19 VDC | |
| Power Consumption: | 32.5 W | 32.5 W | 45 W maximum when battery charging |
| Battery | | | |
| Operating Time: | 10.8 V, 7200 mA-h > 3 hours (Typical) | 10.8 V, 7200 mA-h > 3.5 hours (Typical) | Lithium Ion In balance mode |
| Charge Time: | Approximately 2.5 hours to 80 %, 4 hours to 100 % | Approximately 2.5 hours to 80 %, 4 hours to 100 % | In case of a fully discharged battery |
| Storage Temperature: | -20 to 50 °C (-4 to 122 °F), ≤ 85 % RH | -20 to 50 °C (-4 to 122 °F), ≤ 85 % RH | The battery pack should be stored in an environment with low humidity. Extended exposure to temperature above 45 °C could degrade battery performance and life. |
| Data Storage | | | |
| Internal: | Minimum 20 MB | Minimum 20 MB | Up to 200 instrument states and traces |
| External: | | | Supports USB 2.0 compatible memory devices |
| Environmental | | | |
| Operating Temperature: | -10 to 55 °C (14 to 131 °F) | -10 to 55 °C (14 to 131 °F) | |
| Maximum Humidity: | 85 % | 85 % | |
| Shock and Vibration: | MIL-PRF-28800F Class 2 | MIL-PRF-28800F Class 2 | |
| Storage Temperature: | -55 to 71 °C (-67 to 160 °F) | -55 to 71 °C (-67 to 160 °F) | With the battery pack removed |
| EMC | | | |
| | EN 61326-2-1 | EN 61326-2-1 | Complies with European EMC |
| Size and Weight | | | |
| Weight: | < 4 kg (8.8 lbs) with battery | < 3.6 kg (7.94 lbs) with battery | With standard configuration |
| Size: | 295 x 195 x 82 (mm) 11.6 x 7.7 x 3.2 (Inch) | 295 x 195 x 82 (mm) 11.6 x 7.7 x 3.2 (Inch) | Approximately (W x H x D) |
| Warranty | | | |
| | 2 years | 2 years | |
| Calibration Cycle | | | |
| | 1 year | 1 year | |

APPENDIX B – CABLE LIST

| Cable Type | Relative Propagation Velocity (V _l) | Nominal Attenuation dB/m @ 1000 MHz |
|------------------|---|-------------------------------------|
| FSJ1-50A | 0.84 | 0.197 |
| FSJ250 | 0.83 | 0.134 |
| FSJ4-50B | 0.81 | 0.119 |
| HCC 12-50J | 0.915 | 0.092 |
| HCC 158-50J | 0.95 | 0.023 |
| HCC 300-50J | 0.96 | 0.014 |
| HCC 312-50J | 0.96 | 0.013 |
| HCC 78-50J | 0.915 | 0.042 |
| HF 4-1/8" Cu2Y | 0.97 | 0.01 |
| HF 5" Cu2Y | 0.96 | 0.007 |
| HF 6-1/8" Cu2Y | 0.97 | 0.006 |
| HJ4.5-50 | 0.92 | 0.054 |
| HJ4-50 | 0.914 | 0.087 |
| HJ5-50 | 0.916 | 0.042 |
| HJ7-50A | 0.921 | 0.023 |
| LDF12-50 | 0.88 | 0.022 |
| LDF4-50A | 0.88 | 0.077 |
| LDF5-50A | 0.89 | 0.043 |
| LDF6-50 | 0.89 | 0.032 |
| LDF7-50A | 0.88 | 0.027 |
| LMR100 | 0.8 | 0.792 |
| LMR1200 | 0.88 | 0.044 |
| LMR1700 | 0.89 | 0.033 |
| LMR200 | 0.83 | 0.344 |
| LMR240 | 0.84 | 0.262 |
| LMR400 | 0.85 | 0.135 |
| LMR500 | 0.86 | 0.109 |
| LMR600 | 0.87 | 0.087 |
| LMR900 | 0.87 | 0.056 |
| RG142 | 0.69 | 0.443 |
| RG17, 17A | 0.659 | 0.18 |
| RG174 | 0.66 | 0.984 |
| RG178B | 0.69 | 1.509 |
| RG187, 188 | 0.69 | 1.017 |
| RG213/U | 0.66 | 0.292 |
| RG214 | 0.659 | 0.292 |
| RG223 | 0.659 | 0.165 |
| RG55, 55A, 55B | 0.659 | 0.541 |
| RG58, 58B | 0.659 | 1.574 |
| RG58A, 58C | 0.659 | 0.787 |
| RG8, 8A, 10, 10A | 0.659 | 0.262 |
| RG9, 9A | 0.659 | 0.289 |
| HFSC-12D(1/2") | 0.81 | 0.112 |
| HFC-12D(1/2") | 0.88 | 0.072 |
| HFC-22D(7/8") | 0.88 | 0.041 |
| HFC-33D(1_1/4") | 0.88 | 0.0294 |
| HFC-42D(1_5/8") | 0.87 | 0.0243 |
| RFCX-12D(1/2") | 0.88 | 0.088 |
| RFCX-22D(7/8") | 0.88 | 0.049 |
| RFCX-33D(1_1/4") | 0.88 | 0.038 |
| RFCX-42D(1_5/8") | 0.87 | 0.028 |
| RFCL-22D(7/8") | 0.88 | 0.044 |
| RFCL-33D(1_1/4") | 0.88 | 0.034 |
| RFCL-42D(1_5/8") | 0.87 | 0.0315 |

APPENDIX C – BAND, FREQUENCY & CHANNEL STANDARD

| Standard | Uplink | | | Downlink | | |
|---------------------------|------------------|-----------------|----------------|------------------|-----------------|----------------|
| | Start Freq (MHz) | Stop Freq (MHz) | Valid Channels | Start Freq (MHz) | Stop Freq (MHz) | Valid Channels |
| GSM | | | | | | |
| GSM 450 | 450.40 | 457.60 | 259≤n≤293 | 460.40 | 467.60 | 259≤n≤293 |
| GSM 480 | 478.80 | 486.00 | 306≤n≤340 | 488.80 | 496.00 | 306≤n≤340 |
| GSM 850 | 824.00 | 849.00 | 128≤n≤251 | 869.00 | 894.00 | 128≤n≤251 |
| P-GSM 900 | 890.00 | 915.00 | 1≤n≤124 | 935.00 | 960.00 | 1≤n≤124 |
| E-GSM 900 | 880.00 | 915.00 | 0≤n≤124 | 925.00 | 960.00 | 0≤n≤124 |
| | | | 975≤n≤1023 | | | 975≤n≤1023 |
| R-GSM 900 | 876.00 | 915.00 | 0≤n≤124 | 921.00 | 960.00 | 0≤n≤124 |
| | | | 955≤n≤1023 | | | 955≤n≤1023 |
| R-GSM 900 (China) | 885.00 | 889.00 | 999≤n≤1019 | 930.00 | 934.00 | 999≤n≤1019 |
| DCS 1800 | 1710.00 | 1785.00 | 512≤n≤885 | 1805.00 | 1880.00 | 512≤n≤885 |
| PCS 1900 | 1850.00 | 1910.00 | 512≤n≤810 | 1930.00 | 1990.00 | 512≤n≤810 |
| CDMA | | | | | | |
| Band 0 (800) | 824.00 | 849.00 | 1≤n≤799 | 869.00 | 894.00 | 1≤n≤799 |
| | | | 991≤n≤1023 | | | 991≤n≤1023 |
| Band 1 (NA PCS) | 1850.00 | 1910.00 | 0≤n≤1199 | 1930.00 | 1990.00 | 0≤n≤1199 |
| Band 2 (TACS) | 872.0125 | 914.9875 | 0≤n≤1000 | 917.0125 | 959.9875 | 0≤n≤1000 |
| | | | 1329≤n≤2047 | | | 1329≤n≤2047 |
| Band 3 (JTACS) | 887.0125 | 924.9875 | 1≤n≤799 | 832.0125 | 869.9875 | 1≤n≤799 |
| | | | 801≤n≤1039 | | | 801≤n≤1039 |
| | | | 1041≤n≤1199 | | | 1041≤n≤1199 |
| Band 4 (KR PCS) | 1750.00 | 1780.00 | 0≤n≤599 | 1840.00 | 1870.00 | 0≤n≤599 |
| | | | 1≤n≤300 | | | 1≤n≤300 |
| Band 5 (450) | 411.675 | 483.480 | 539≤n≤871 | 421.6750 | 493.4800 | 539≤n≤871 |
| | | | 1039≤n≤1473 | | | 1039≤n≤1473 |
| | | | 1792≤n≤2016 | | | 1792≤n≤2016 |
| Band 6 (2100) | 1920.00 | 1980.00 | 0≤n≤1199 | 2100.00 | 2170.00 | 0≤n≤1199 |
| Band 7 (700) | 776.00 | 794.00 | 0≤n≤359 | 746.00 | 764.00 | 0≤n≤359 |
| Band 8 (1800) | 1710.00 | 1784.95 | 0≤n≤1499 | 1805.00 | 1879.95 | 0≤n≤1499 |
| Band 9 (900) | 880.00 | 914.95 | 0≤n≤699 | 925.00 | 959.95 | 0≤n≤699 |
| Band 10 (2nd 800) | 806.000 | 900.975 | 0≤n≤719 | 851.000 | 939.975 | 0≤n≤719 |
| | | | 720≤n≤919 | | | 720≤n≤919 |
| WCDMA | | | | | | |
| Band Global | | | | | | |
| Band 1 (2100-General) | 1920.0 | 1980.0 | 9612≤n≤9888 | 2110.0 | 2170.0 | 10562≤n≤10838 |
| Band 2 (1900-General) | 1850.0 | 1910.0 | 9262≤n≤9538 | 1930.0 | 1990.0 | 9662≤n≤9938 |
| Band 2 (1900-Additional) | | | 12≤n≤287 | | | 412≤n≤687 |
| Band 3 (1800-General) | 1710.0 | 1780.0 | 937≤n≤1288 | 1805.0 | 1880.0 | 1162≤n≤1513 |
| Band 4 (1700-General) | 1710.0 | 1775.0 | 1312≤n≤1513 | 2110.0 | 2155.0 | 1537≤n≤1738 |
| Band 4 (1700-Additional) | | | 1662≤n≤1862 | | | 1887≤n≤2087 |
| Band 5 (850-General) | 824.0 | 849.0 | 4132≤n≤4233 | 869.0 | 894.0 | 4357≤n≤4458 |
| Band 5 (850-Additional) | | | 782≤n≤862 | | | 1007≤n≤1087 |
| Band 6 (800-General) | 830.0 | 840.0 | 4162≤n≤4188 | 875.0 | 885.0 | 4387≤n≤4413 |
| Band 6 (800-Additional) | | | 812≤n≤837 | | | 1037≤n≤1062 |
| Band 7 (2600-General) | 2500.0 | 2570.0 | 2012≤n≤2338 | 2620.0 | 2690.0 | 2237≤n≤2563 |
| Band 7 (2600-Additional) | | | 2362≤n≤2687 | | | 2587≤n≤2912 |
| Band 8 (900-General) | 880.0 | 915.0 | 2712≤n≤2863 | 925.0 | 960.0 | 2937≤n≤3088 |
| Band 9 (1700-General) | 1749.9 | 1784.9 | 8762≤n≤8912 | 1844.9 | 1879.9 | 9237≤n≤9387 |
| Band 10 (1700-General) | 1710.0 | 1770.0 | 2887≤n≤3163 | 2110.0 | 2170.0 | 3112≤n≤3388 |
| Band 10 (1700-Additional) | | | 3187≤n≤3462 | | | 3412≤n≤3687 |
| Band 11 (1500-General) | 1427.9 | 1447.9 | 3487≤n≤3562 | 1475.9 | 1495.9 | 3712≤n≤3787 |
| Band 12 (700-General) | 699.0 | 716.0 | 3617≤n≤3678 | 729.0 | 746.0 | 3842≤n≤3903 |
| Band 12 (700-Additional) | | | 3707≤n≤3767 | | | 3932≤n≤3992 |
| Band 13 (700-General) | 777.0 | 787.0 | 3792≤n≤3818 | 746.0 | 756.0 | 4017≤n≤4043 |
| Band 13 (700-Additional) | | | 3842≤n≤3867 | | | 4067≤n≤4092 |
| Band 14 (700-General) | 788.0 | 798.0 | 3892≤n≤3918 | 758.0 | 768.0 | 4117≤n≤4143 |
| Band 14 (700-Additional) | | | 3942≤n≤3967 | | | 4167≤n≤4192 |

| Standard | Uplink | | | Downlink | | |
|---------------------------|------------------|-----------------|----------------|------------------|-----------------|----------------|
| | Start Freq (MHz) | Stop Freq (MHz) | Valid Channels | Start Freq (MHz) | Stop Freq (MHz) | Valid Channels |
| Band 19 (800-General) | 830.0 | 845.0 | 312≤n≤363 | 875.0 | 890.0 | 712≤n≤763 |
| Band 19 (800-Additional) | | | 387≤n≤437 | | | 787≤n≤837 |
| Band 20 (800-General) | 832.0 | 862.0 | 4287≤n≤4413 | 791.0 | 821.0 | 4512≤n≤4638 |
| Band 21 (1500-General) | 1447.9 | 1462.9 | 462≤n≤512 | 1495.9 | 1510.9 | 862≤n≤912 |
| Band 22 (3500-General) | 3410.0 | 3490.0 | 4437≤n≤4813 | 3510.0 | 3590.0 | 4662≤n≤5038 |
| Band 25 (1900-General) | 1850.0 | 1915.0 | 4887≤n≤5188 | 1930.0 | 1995.0 | 5112≤n≤5413 |
| Band 25 (1900-Additional) | | | 5212≤n≤5512 | | | 5437≤n≤5737 |
| Band 26 (800-General) | 814.0 | 849.0 | 5537≤n≤5688 | 859.0 | 894.0 | 5762≤n≤5913 |
| Band 26 (800-Additional) | | | 5712≤n≤5862 | | | 5937≤n≤6087 |
| LTE - FDD | | | | | | |
| Band Global | | | | | | |
| Band 1 (2100) | 1920.0 | 1980.0 | 18000≤n≤18599 | 2110.0 | 2170.0 | 0≤n≤599 |
| Band 2 (1900) | 1850.0 | 1910.0 | 18600≤n≤19199 | 1930.0 | 1990.0 | 600≤n≤1199 |
| Band 3 (1800) | 1710.0 | 1785.0 | 19200≤n≤19949 | 1805.0 | 1880.0 | 1200≤n≤1949 |
| Band 4 (1700) | 1710.0 | 1755.0 | 19950≤n≤20399 | 2110.0 | 2155.0 | 1950≤n≤2399 |
| Band 5 (850) | 824.0 | 849.0 | 20400≤n≤20649 | 869.0 | 894.0 | 2400≤n≤2649 |
| Band 7 (2600) | 2500.0 | 2570.0 | 20750≤n≤21449 | 2620.0 | 2690.0 | 2750≤n≤3449 |
| Band 8 (900) | 880.0 | 915.0 | 21450≤n≤21799 | 925.0 | 960.0 | 3450≤n≤3799 |
| Band 9 (1700) | 1749.9 | 1784.9 | 21800≤n≤22149 | 1844.9 | 1879.9 | 3800≤n≤4149 |
| Band 10 (1700) | 1710.0 | 1770.0 | 22150≤n≤22749 | 2110.0 | 2170.0 | 4150≤n≤4749 |
| Band 11 (1500) | 1427.9 | 1447.9 | 22750≤n≤22949 | 1475.9 | 1495.9 | 4750≤n≤4949 |
| Band 12 (700) | 699.0 | 716.0 | 23010≤n≤23179 | 729.0 | 746.0 | 5010≤n≤5179 |
| Band 13 (700) | 777.0 | 787.0 | 23180≤n≤23279 | 746.0 | 756.0 | 5180≤n≤5279 |
| Band 14 (700) | 788.0 | 798.0 | 23280≤n≤23379 | 758.0 | 768.0 | 5280≤n≤5379 |
| Band 17 (700) | 704.0 | 716.0 | 23730≤n≤23849 | 734.0 | 746.0 | 5730≤n≤5849 |
| Band 18 (800) | 815.0 | 830.0 | 23850≤n≤23999 | 860.0 | 875.0 | 5850≤n≤5999 |
| Band 19 (800) | 830.0 | 845.0 | 24000≤n≤24149 | 875.0 | 890.0 | 6000≤n≤6149 |
| Band 20 (800) | 832.0 | 862.0 | 24150≤n≤24449 | 791.0 | 821.0 | 6150≤n≤6449 |
| Band 21 (1500) | 1447.9 | 1462.9 | 24450≤n≤24599 | 1495.9 | 1510.9 | 6450≤n≤6599 |
| Band 22 (3500) | 3410.0 | 3490.0 | 24600≤n≤25399 | 3510.0 | 3590.0 | 6600≤n≤7399 |
| Band 23 (2100) | 2000.0 | 2020.0 | 25500≤n≤25699 | 2180.0 | 2200.0 | 7500≤n≤7699 |
| Band 24 (1500) | 1626.5 | 1660.5 | 25700≤n≤26039 | 1525.0 | 1559.0 | 7700≤n≤8039 |
| Band 25 (1900) | 1850.0 | 1915.0 | 26040≤n≤26689 | 1930.0 | 1995.0 | 8040≤n≤8689 |
| Band 26 (800) | 814.0 | 849.0 | 26690≤n≤27039 | 859.0 | 894.0 | 8690≤n≤9039 |
| LTE - TDD | | | | | | |
| Band Global | | | | | | |
| Band 33 (1900) | 1900.0 | 1920.0 | 36000≤n≤36199 | | | |
| Band 34 (2100) | 2010.0 | 2025.0 | 36200≤n≤36349 | | | |
| Band 35 (1850) | 1850.0 | 1910.0 | 36350≤n≤36949 | | | |
| Band 36 (1930) | 1930.0 | 1990.0 | 36950≤n≤37549 | | | |
| Band 37 (1910) | 1910.0 | 1930.0 | 37550≤n≤37749 | | | |
| Band 38 (2570) | 2570.0 | 2620.0 | 37750≤n≤38249 | | | |
| Band 39 (1880) | 1880.0 | 1920.0 | 38250≤n≤38649 | | | |
| Band 40 (2300) | 2300.0 | 2400.0 | 38650≤n≤39649 | | | |
| Band 41 (2496) | 2496.0 | 2690.0 | 39650≤n≤41589 | | | |
| Band 42 (3400) | 3400.0 | 3600.0 | 41590≤n≤43589 | | | |
| Band 43 (3600) | 3600.0 | 3800.0 | 43590≤n≤45589 | | | |
| TD-SCDMA | | | | | | |
| FBN 0 | 1785.0 | 1805.0 | 0≤n≤92 | | | |
| FBN 1 | 1900.0 | 1920.0 | 0≤n≤92 | | | |
| FBN 2 | 1920.0 | 1980.0 | 0≤n≤255 | | | |
| FBN 3 | 1920.0 | 1980.0 | 0≤n≤36 | | | |
| FBN 4 | 1980.0 | 2010.0 | 0≤n≤142 | | | |
| FBN 5 | 2010.0 | 2025.0 | 0≤n≤67 | | | |
| FBN 6 | 2100.0 | 2170.0 | 0≤n≤255 | | | |
| FBN 7 | 2100.0 | 2170.0 | 0≤n≤36 | | | |
| FBN 8 | 2170.0 | 2220.0 | 0≤n≤242 | | | |
| WiMAX | | | | | | |
| ProfR1 (1.25 2150) | 2150.625 | 2159.375 | 0≤n≤7 | | | |
| ProfR2 (1.25 2305) | 2305.625 | 2320.625 | 0≤n≤12 | | | |
| ProfR3 (1.25 2361) | 2361.875 | 2375.625 | 13≤n≤24 | | | |
| ProfR4 (1.25 2500) | 2500.625 | 2688.125 | 0≤n≤150 | | | |
| ProfR5 (1.25 3400) | 3400.625 | 3700.625 | 0≤n≤240 | | | |

| Standard | Uplink | | | Downlink | | |
|---------------------|------------------|-----------------|----------------|------------------|-----------------|----------------|
| | Start Freq (MHz) | Stop Freq (MHz) | Valid Channels | Start Freq (MHz) | Stop Freq (MHz) | Valid Channels |
| ProfR6 (3.5 2598) | 2524.750 | 2591.250 | 0≤n≤38 | 2598.750 | 2665.250 | 0≤n≤38 |
| ProfR7 (3.5 3461) | 3411.750 | 3443.250 | 0≤n≤18 | 3461.750 | 3493.250 | 0≤n≤18 |
| ProfR8 (3.5 3551) | 3501.750 | 3598.000 | 0≤n≤55 | 3551.750 | 3648.000 | 0≤n≤55 |
| ProfR9 (3.5 3651) | 3601.750 | 3698.000 | 0≤n≤55 | 3651.750 | 3748.000 | 0≤n≤55 |
| ProfR10 (3.5 3751) | 3701.750 | 3798.000 | 0≤n≤55 | 3751.750 | 3848.000 | 0≤n≤55 |
| ProfR11 (7 2600) | 2526.500 | 2589.500 | 0≤n≤36 | 2600.500 | 2663.500 | 0≤n≤36 |
| ProfR12 (7 3463) | 2413.500 | 3441.500 | 0≤n≤16 | 3463.500 | 3491.500 | 0≤n≤16 |
| ProfR13 (7 3553) | 3503.500 | 3596.250 | 0≤n≤53 | 3553.500 | 3646.250 | 0≤n≤53 |
| ProfR14 (7 3653) | 3603.500 | 3696.250 | 0≤n≤53 | 3653.500 | 3746.250 | 0≤n≤53 |
| ProfR15 (7 3753) | 3703.500 | 3796.250 | 0≤n≤53 | 3753.500 | 3846.250 | 0≤n≤53 |
| ProfR26 (10 5275) | 5275.000 | 5335.000 | 55≤n≤67 | | | |
| ProfR27 (10 5740) | 5740.000 | 5830.000 | 148≤n≤166 | | | |
| ProfR28 (10 5735) | 5735.000 | 5845.000 | 147≤n≤169 | | | |
| ProfR29 (8.75 2304) | 2304.375 | 2395.625 | 0≤n≤730 | | | |

APPENDIX D – VSWR-RETURN LOSS CONVERSION TABLE

This information is for the Cable and Antenna Analyzer mode of the JD745A Base Station Analyzer and the JD746A RF Analyzer.

n $Return\ Loss = 20 \log_{10}(VSWR + 1 / VSWR - 1)$ (dB)

n $VSWR = (10^{RL/20} + 1) / (10^{RL/20} - 1)$

| VSWR | Return Loss (dB) | Trans. Loss (dB) | Volt. Refl Coeff | Power Trans (%) | Power Refl (%) |
|------|------------------|------------------|------------------|-----------------|----------------|
| 1.00 | -- | 0.000 | 0.00 | 100.0 | 0.0 |
| 1.01 | 46.1 | 0.000 | 0.00 | 100.0 | 0.0 |
| 1.02 | 40.1 | 0.000 | 0.01 | 100.0 | 0.0 |
| 1.03 | 36.6 | 0.001 | 0.01 | 100.0 | 0.0 |
| 1.04 | 34.2 | 0.002 | 0.02 | 100.0 | 0.0 |
| 1.05 | 32.3 | 0.003 | 0.02 | 99.9 | 0.1 |
| 1.06 | 30.7 | 0.004 | 0.03 | 99.9 | 0.1 |
| 1.07 | 29.4 | 0.005 | 0.03 | 99.9 | 0.1 |
| 1.08 | 28.3 | 0.006 | 0.04 | 99.9 | 0.1 |
| 1.09 | 27.3 | 0.008 | 0.04 | 99.8 | 0.2 |
| 1.10 | 26.4 | 0.010 | 0.05 | 99.8 | 0.2 |
| 1.11 | 25.7 | 0.012 | 0.05 | 99.7 | 0.3 |
| 1.12 | 24.9 | 0.014 | 0.06 | 99.7 | 0.3 |
| 1.13 | 24.3 | 0.016 | 0.06 | 99.6 | 0.4 |
| 1.14 | 23.7 | 0.019 | 0.07 | 99.6 | 0.4 |
| 1.15 | 23.1 | 0.021 | 0.07 | 99.5 | 0.5 |
| 1.16 | 22.6 | 0.024 | 0.07 | 99.5 | 0.5 |
| 1.17 | 22.1 | 0.027 | 0.08 | 99.4 | 0.6 |
| 1.18 | 21.7 | 0.030 | 0.08 | 99.3 | 0.7 |
| 1.19 | 21.2 | 0.033 | 0.09 | 99.2 | 0.8 |
| 1.20 | 20.8 | 0.036 | 0.09 | 99.2 | 0.8 |
| 1.21 | 20.4 | 0.039 | 0.10 | 99.1 | 0.9 |
| 1.22 | 20.1 | 0.043 | 0.10 | 99.0 | 1.0 |
| 1.23 | 19.7 | 0.046 | 0.10 | 98.9 | 1.1 |
| 1.24 | 19.4 | 0.050 | 0.11 | 98.9 | 1.1 |
| 1.25 | 19.1 | 0.054 | 0.11 | 98.8 | 1.2 |
| 1.26 | 18.8 | 0.058 | 0.12 | 98.7 | 1.3 |
| 1.27 | 18.5 | 0.062 | 0.12 | 98.6 | 1.4 |
| 1.28 | 18.2 | 0.066 | 0.12 | 98.5 | 1.5 |
| 1.29 | 17.9 | 0.070 | 0.13 | 98.4 | 1.6 |
| 1.30 | 17.7 | 0.075 | 0.13 | 98.3 | 1.7 |
| 1.32 | 17.2 | 0.083 | 0.14 | 98.1 | 1.9 |
| 1.34 | 16.8 | 0.093 | 0.15 | 97.9 | 2.1 |
| 1.36 | 16.3 | 0.102 | 0.15 | 97.7 | 2.3 |
| 1.38 | 15.9 | 0.112 | 0.16 | 97.5 | 2.5 |
| 1.40 | 15.8 | 0.122 | 0.17 | 97.2 | 2.8 |
| 1.42 | 15.2 | 0.133 | 0.17 | 97.0 | 3.0 |
| 1.44 | 14.9 | 0.144 | 0.18 | 96.7 | 3.3 |
| 1.46 | 14.6 | 0.155 | 0.19 | 96.5 | 3.5 |
| 1.48 | 14.3 | 0.166 | 0.19 | 96.3 | 3.7 |
| 1.50 | 14.0 | 0.177 | 0.20 | 96.0 | 4.0 |
| 1.52 | 13.7 | 0.189 | 0.21 | 95.7 | 4.3 |
| 1.54 | 13.4 | 0.201 | 0.21 | 95.5 | 4.5 |
| 1.56 | 13.2 | 0.213 | 0.22 | 95.2 | 4.8 |
| 1.58 | 13.0 | 0.225 | 0.22 | 94.9 | 5.1 |
| 1.60 | 12.7 | 0.238 | 0.23 | 94.7 | 5.3 |
| 1.62 | 12.5 | 0.250 | 0.24 | 94.4 | 5.6 |

| VSWR | Return Loss (dB) | Trans. Loss (dB) | Volt. Refl Coeff | Power Trans (%) | Power Refl (%) |
|-------|------------------|------------------|------------------|-----------------|----------------|
| 1.64 | 12.3 | 0.263 | 0.24 | 94.1 | 5.9 |
| 1.66 | 12.1 | 0.276 | 0.25 | 93.8 | 6.2 |
| 1.68 | 11.9 | 0.289 | 0.25 | 93.6 | 6.4 |
| 1.70 | 11.7 | 0.302 | 0.26 | 93.3 | 6.7 |
| 1.72 | 11.5 | 0.315 | 0.26 | 93.0 | 7.0 |
| 1.74 | 11.4 | 0.329 | 0.27 | 92.7 | 7.3 |
| 1.76 | 11.2 | 0.342 | 0.28 | 92.4 | 7.6 |
| 1.78 | 11.0 | 0.356 | 0.28 | 92.1 | 7.9 |
| 1.80 | 10.9 | 0.370 | 0.29 | 91.8 | 8.2 |
| 1.82 | 10.7 | 0.384 | 0.29 | 91.5 | 8.5 |
| 1.84 | 10.6 | 0.398 | 0.30 | 91.3 | 8.7 |
| 1.86 | 10.4 | 0.412 | 0.30 | 91.0 | 9.0 |
| 1.88 | 10.3 | 0.426 | 0.31 | 90.7 | 9.3 |
| 1.90 | 10.2 | 0.440 | 0.31 | 90.4 | 9.6 |
| 1.92 | 10.0 | 0.454 | 0.32 | 90.1 | 9.9 |
| 1.94 | 9.9 | 0.468 | 0.32 | 89.8 | 10.2 |
| 1.96 | 9.8 | 0.483 | 0.32 | 89.5 | 10.5 |
| 1.98 | 9.7 | 0.497 | 0.33 | 89.2 | 10.8 |
| 2.00 | 9.5 | 0.512 | 0.33 | 88.9 | 11.1 |
| 2.50 | 7.4 | 0.881 | 0.43 | 81.6 | 18.4 |
| 3.00 | 6.0 | 1.249 | 0.50 | 75.0 | 25.0 |
| 3.50 | 5.1 | 1.603 | 0.56 | 69.1 | 30.9 |
| 4.00 | 4.4 | 1.938 | 0.60 | 64.0 | 36.0 |
| 4.50 | 3.9 | 2.255 | 0.64 | 59.5 | 40.5 |
| 5.00 | 3.5 | 2.553 | 0.67 | 55.6 | 44.4 |
| 5.50 | 3.2 | 2.834 | 0.69 | 52.1 | 47.9 |
| 6.00 | 2.9 | 3.100 | 0.71 | 49.0 | 51.0 |
| 6.50 | 2.7 | 3.351 | 0.73 | 46.2 | 53.8 |
| 7.00 | 2.5 | 3.590 | 0.75 | 43.7 | 56.3 |
| 7.50 | 2.3 | 3.817 | 0.76 | 41.5 | 58.5 |
| 8.00 | 2.2 | 4.033 | 0.78 | 39.5 | 60.5 |
| 8.50 | 2.1 | 4.240 | 0.79 | 37.7 | 62.3 |
| 9.00 | 1.9 | 4.437 | 0.80 | 36.0 | 64.0 |
| 9.50 | 1.8 | 4.626 | 0.81 | 34.5 | 65.5 |
| 10.00 | 1.7 | 4.807 | 0.82 | 33.1 | 66.9 |
| 11.00 | 1.6 | 5.149 | 0.83 | 30.6 | 69.4 |
| 12.00 | 1.5 | 5.466 | 0.85 | 28.4 | 71.6 |
| 13.00 | 1.3 | 5.762 | 0.86 | 26.5 | 73.5 |
| 14.00 | 1.2 | 6.040 | 0.87 | 24.9 | 75.1 |
| 15.00 | 1.2 | 6.301 | 0.88 | 23.4 | 76.6 |
| 16.00 | 1.1 | 6.547 | 0.88 | 22.1 | 77.9 |
| 17.00 | 1.0 | 6.780 | 0.89 | 21.0 | 79.0 |
| 18.00 | 1.0 | 7.002 | 0.89 | 19.9 | 80.1 |
| 19.00 | 0.9 | 7.212 | 0.90 | 19.0 | 81.0 |
| 20.00 | 0.9 | 7.413 | 0.90 | 18.1 | 81.9 |
| 25.00 | 0.7 | 8.299 | 0.92 | 14.8 | 85.2 |
| 30.00 | 0.6 | 9.035 | 0.94 | 12.5 | 87.5 |

APPENDIX E – CYCLIC PREFIX TABLE

This information is for the LTE – FDD Signal Analyzer mode and the LTE – TDD Signal Analyzer mode of the JD745A Base Station Analyzer and the JD748A Signal Analyzer. Following table shows OFDM parameter details by different bandwidth.

| Bandwidth | Configuration (Downlink) | | Cyclic Prefix Length | |
|-----------|--------------------------|-------------------------|--------------------------|--------------------|
| | | | TS | uSec |
| 20 MHz | Normal CP | $\Delta f=15\text{KHz}$ | 160 for $l=0$ | 5.208 |
| | | | 144 for $l=1,2,\dots,6$ | 4.6875 |
| | Extended CP | $\Delta f=15\text{KHz}$ | 512 for $l=0,1,\dots,5$ | 16.667 |
| | | | $\Delta f=7.5\text{KHz}$ | 1024 for $l=0,1,2$ |
| 15 MHz | Normal CP | $\Delta f=15\text{KHz}$ | 120 for $l=0$ | 5.208 |
| | | | 108 for $l=1,2,\dots,6$ | 4.6875 |
| | Extended CP | $\Delta f=15\text{KHz}$ | 384 for $l=0,1,\dots,5$ | 16.667 |
| | | | $\Delta f=7.5\text{KHz}$ | 768 for $l=0,1,2$ |
| 10 MHz | Normal CP | $\Delta f=15\text{KHz}$ | 80 for $l=0$ | 5.208 |
| | | | 72 for $l=1,2,\dots,6$ | 4.6875 |
| | Extended CP | $\Delta f=15\text{KHz}$ | 256 for $l=0,1,\dots,5$ | 16.667 |
| | | | $\Delta f=7.5\text{KHz}$ | 512 for $l=0,1,2$ |
| 5 MHz | Normal CP | $\Delta f=15\text{KHz}$ | 40 for $l=0$ | 5.208 |
| | | | 36 for $l=1,2,\dots,6$ | 4.6875 |
| | Extended CP | $\Delta f=15\text{KHz}$ | 128 for $l=0,1,\dots,5$ | 16.667 |
| | | | $\Delta f=7.5\text{KHz}$ | 248 for $l=0,1,2$ |
| 3 MHz | Normal CP | $\Delta f=15\text{KHz}$ | 20 for $l=0$ | 5.208 |
| | | | 18 for $l=1,2,\dots,6$ | 4.6875 |
| | Extended CP | $\Delta f=15\text{KHz}$ | 64 for $l=0,1,\dots,5$ | 16.667 |
| | | | $\Delta f=7.5\text{KHz}$ | 128 for $l=0,1,2$ |
| 1.4 MHz | Normal CP | $\Delta f=15\text{KHz}$ | 10 for $l=0$ | 5.208 |
| | | | 9 for $l=1,2,\dots,6$ | 4.6875 |
| | Extended CP | $\Delta f=15\text{KHz}$ | 32 for $l=0,1,\dots,5$ | 16.667 |
| | | | $\Delta f=7.5\text{KHz}$ | 64 for $l=0,1,2$ |

APPENDIX F – MOTOROLA CDMA/EV-DO LMF

Motorola's CDMA/EV-DO base stations (BTS) are optimized with the assistance of Local Maintenance Facility (LMF), a Motorola's software tool that interfaces with the cell site and the instrument. The optimization process identifies the accumulated loss (or gain) for all receive and transmit paths at the cell site and stores that value in the system's database.

JD740A Series LMF Interface

An emulation interface to LMF has been implemented in JDSU's base station analyzer (JD745A) in order to perform the BTS optimization procedures. The scope of this emulation is to perform the maintenance tests of TX Calibration and TX Audit required in routine maintenance practices with or without the use of an external power sensor. Using the external power sensor, the user can get highly accurate measurement results.

LMF Test Setup

USING INTERNAL POWER SENSOR

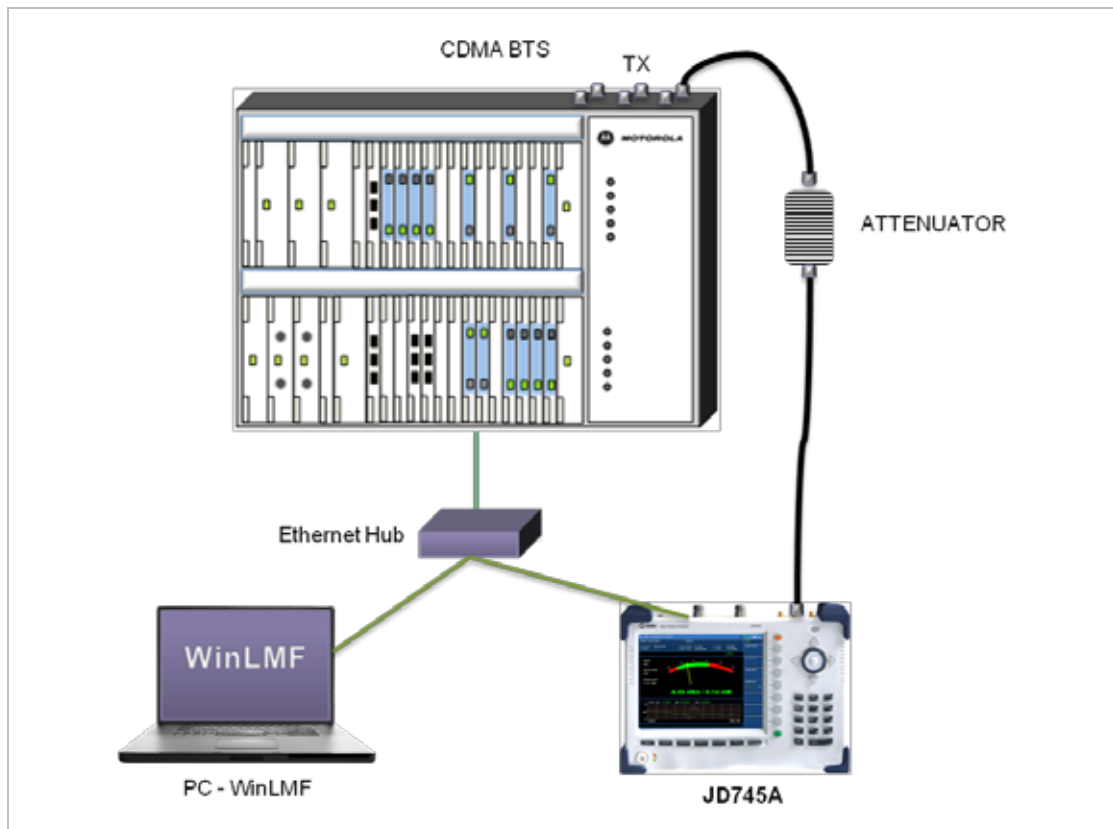

USING EXTERNAL POWER SENSOR

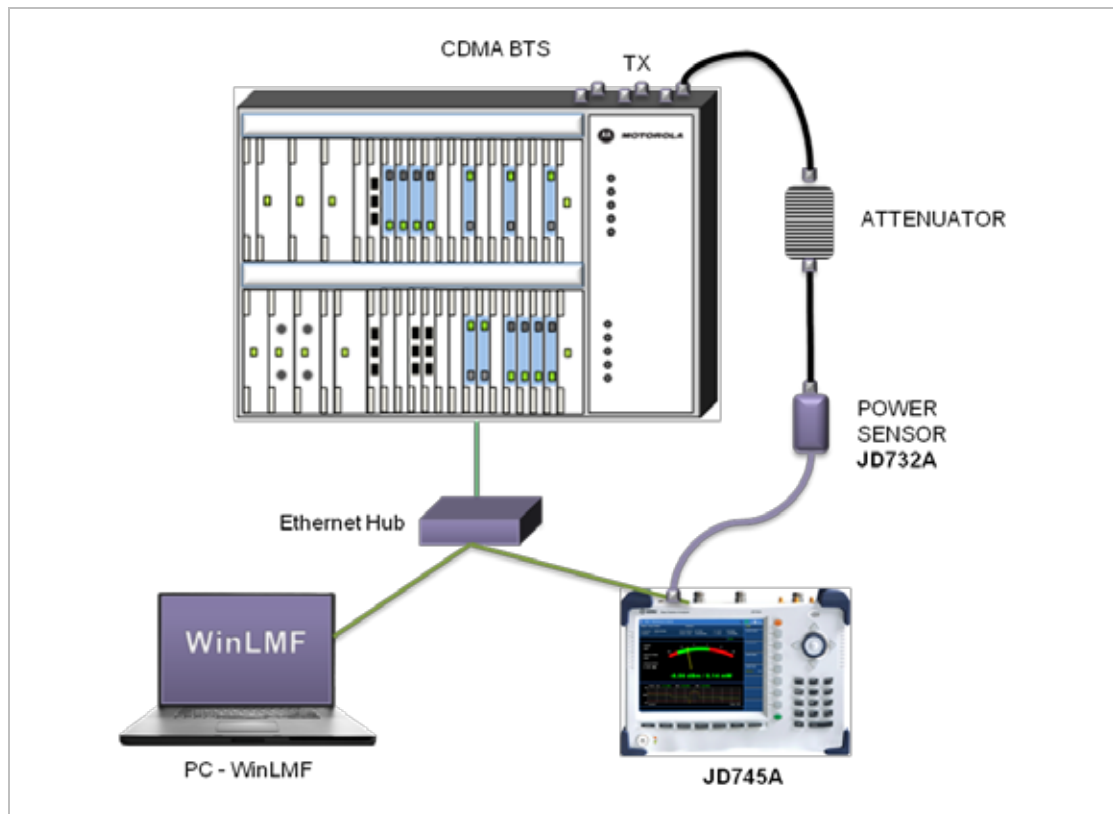

LMF Test Procedure

| Step | Description |
|--|--|
| 1. Connect the instrument with BTS and PC | <p><u>Using Internal Power Sensor:</u></p> <p>As shown in the LMF Test Setup with Using Internal Power Sensor, connect the Motorola CDMA/EV-DO BTS with the Spectrum Analyzer RF In 50 port of JD745A and connect the WinLMF running PC with JD745A via a hub.</p> <p><u>Using External Power Sensor:</u></p> <p>As shown in the LMF Test Setup with Using External Power Sensor, connect an external power sensor to the USB Host port of JD745A and to the BTS and connect the WinLMF running PC with JD745A via a hub.</p> |
| 2. Set the IP address and LMF mode SYSTEM [More (1/2)] [LAN] [IP Address] | <p>Press the SYSTEM hot key.</p> <p>Press the More (1/2) soft key.</p> <p>Press the LAN soft key.</p> <p>Press the IP Address soft key.</p> |

| | |
|--|---|
| <p>Enter 192.168.10.1</p> <p>[Enter] or [ENTER]</p> <p>[Apply]</p> <p>[LMF Settings]</p> <p>[LMF Mode]</p> <p><On> or <Off></p> <p>[External PM 800 MHz Band], [External PM 1900 MHz Band], [Internal PM 800 MHz Band], or [Internal PM 1900 MHz Band]</p> | <p>Use the numeric keys to enter the IP address 192.168.10.1 including the dots.</p> <p>Press the Enter soft key or the ENTER hard key.</p> <p>Press the Apply soft key.</p> <p>Press the LMF Settings soft key.</p> <p>Press the LAN Mode soft key to enable or disable LMF tests. Toggle this key between On and Off.</p> <p>Select one of the soft keys to choose, depending on the measurement mode (internal or external) and the band of the BTS (800 MHz for Cellular or 1900 MHz for PCS). For example, if the user wants to performance LMF tests with external power measurement on a Motorola CDMA/EV-DO BTS for cellular, the External PM 800 MHz Band soft key should be selected.</p> |
| <p>3. Select the measurement mode</p> <p>MODE</p> <p>[Power Meter]</p> <p>[Internal RF Power Meter] or [External RF Power Meter]</p> | <p>Press the MODE hard key.</p> <p>Press the Power Meter soft key.</p> <p>Press either Internal RF Power Meter soft key or External RF Power Meter soft key according to the LMF settings.</p> |

LMF Test Procedure

APPENDIX G – ORDERING INFORMATION

JD745A Base Station Analyzer

JD745A

| | | |
|------------------|---|---------------|
| 100 kHz to 4 GHz | Spectrum Analyzer | |
| 5 MHz to 4 GHz | Cable and Antenna Analyzer ¹ | |
| 10 MHz to 4 GHz | RF Power Meter | Internal mode |

Options

NOTE: Upgrade options for the JD745A use the designation JD745AU before the respective last three digit option number.

| | | |
|-----------|---|-----------------------|
| JD745A001 | 2 Port Transmission Measurements ² | |
| JD745A002 | Bias Tee | (Requires option 01) |
| JD745A003 | CW Signal Generator | |
| JD745A004 | E1 Analyzer ³ | |
| JD745A005 | T1 Analyzer ³ | |
| JD745A010 | GPS Receiver and Antenna | |
| JD745A011 | Interference Analyzer ^{4, 5} | |
| JD745A012 | Channel Scanner | |
| JD745A013 | Optical Power Meter | |
| JD745A020 | cdmaOne/CDMA2000 Signal Analyzer | |
| JD745A021 | EV-DO Signal Analyzer | (Requires option 20) |
| JD745A022 | GSM/GPRS/EDGE Signal Analyzer | |
| JD745A023 | WCDMA Signal Analyzer | |
| JD745A024 | HSDPA Signal Analyzer | (Requires option 23) |
| JD745A025 | TD-SCDMA Signal Analyzer | |
| JD745A026 | Mobile WiMAX Signal Analyzer | |
| JD745A028 | LTE - FDD Signal Analyzer | |
| JD745A029 | LTE - TDD Signal Analyzer | |
| JD745A040 | cdmaOne/CDMA2000 OTA Analyzer ⁵ | (Requires options 10) |
| JD745A041 | EV-DO OTA Analyzer ⁵ | (Requires options 10) |
| JD745A042 | GSM/GPRS/EDGE OTA Analyzer ⁵ | (Requires options 10) |
| JD745A043 | WCDMA/HSDPA OTA Analyzer ⁵ | (Requires options 10) |
| JD745A045 | TD-SCDMA OTA Analyzer ⁵ | (Requires options 10) |
| JD745A046 | Mobile WiMAX OTA Analyzer ⁵ | (Requires options 10) |
| JD745A048 | LTE OTA - FDD Analyzer ⁵ | (Requires options 10) |
| JD745A049 | LTE OTA - TDD Analyzer ⁵ | (Requires options 10) |

¹Requires Calibration Kit

²Requires Dual port Calibration Kit

³Requires Test Cable

⁴Highly recommended adding JD745A010

⁵Highly recommended adding G70005035x and/or G70005036x

Standard Accessories

| | |
|------------|---|
| G710550326 | AC/DC Power Adapter ⁶ |
| G710550335 | Cross LAN Cable (1.5 m) ⁶ |
| GC73050515 | USB A to B Cable (1.8 m) ⁶ |
| GC72450518 | > 1 G Byte USB Memory ⁶ |
| G710550325 | Rechargeable Lithium Ion Battery ⁶ |
| G710550323 | Automotive Cigarette Lighter 12 VCD Adapter ⁶ |
| JD740A361 | JD740A Series User's Manual and Application Software – CD |

⁶Standard accessories can be purchased separately.

JD746A RF Analyzer

JD746A

| | | |
|------------------|---|---------------|
| 100 kHz to 4 GHz | Spectrum Analyzer | |
| 5 MHz to 4 GHz | Cable and Antenna Analyzer ¹ | |
| 10 MHz to 4 GHz | RF Power Meter | Internal mode |

Options

NOTE: Upgrade options for the JD746A use the designation JD746AU before the respective last three digit option number.

| | | |
|-----------|---|----------------------|
| JD746A001 | 2 Port Transmission Measurements ² | |
| JD746A002 | Bias Tee | (Requires option 01) |
| JD746A003 | CW Signal Generator | |
| JD746A010 | GPS Receiver and Antenna | |
| JD746A011 | Interference Analyzer ^{3,4} | |
| JD746A012 | Channel Scanner | |
| JD745A013 | Optical Power Meter | |

¹Requires Calibration Kit

²Requires Dual port Calibration Kit

³Highly recommended adding JD746A010

⁴Highly recommended adding G70005035x and/or G70005036x

Standard Accessories

| | |
|------------|---|
| G710550326 | AC/DC Power Adapter ⁵ |
| G710550335 | Cross LAN Cable (1.5 m) ⁵ |
| GC73050515 | USB A to B Cable (1.8 m) ⁵ |
| GC72450518 | > 1 G Byte USB Memory ⁵ |
| G710550325 | Rechargeable Lithium Ion Battery ⁵ |
| G710550323 | Automotive Cigarette Lighter 12 VCD Adapter ⁵ |
| JD740A361 | JD740A Series User's Manual and Application Software – CD |

⁵Standard accessories can be purchased separately.

JD748A Signal Analyzer

JD748A

| | | |
|------------------|-------------------|---------------|
| 100 kHz to 4 GHz | Spectrum Analyzer | |
| 10 MHz to 4 GHz | RF Power Meter | Internal mode |

Options

NOTE: Upgrade options for the JD748A use the designation JD748AU before the respective last three digit option number.

| | | |
|-----------|--|-----------------------------|
| JD748A009 | 10 MHz Demodulation Hardware | |
| JD748A010 | GPS Receiver and Antenna | |
| JD748A011 | Interference Analyzer ^{1,2} | |
| JD748A012 | Channel Scanner | |
| JD748A013 | Optical Power Meter | |
| JD748A020 | cdmaOne/CDMA2000 Signal Analyzer | (Requires option 9) |
| JD748A021 | EV-DO Signal Analyzer | (Requires option 9 and 20) |
| JD748A022 | GSM/GPRS/EDGE Signal Analyzer | (Requires option 9) |
| JD748A023 | WCDMA Signal Analyzer | (Requires option 9) |
| JD748A024 | HSDPA Signal Analyzer | (Requires option 9 and 23) |
| JD748A025 | TD-SCDMA Signal Analyzer | (Requires option 9) |
| JD748A026 | Mobile WiMAX Signal Analyzer | (Requires option 9) |
| JD748A028 | LTE - FDD Signal Analyzer | (Requires option 9) |
| JD748A029 | LTE - TDD Signal Analyzer | (Requires option 9) |
| JD748A040 | cdmaOne/CDMA2000 OTA Analyzer ² | (Requires options 9 and 10) |
| JD748A041 | EV-DO OTA Analyzer ² | (Requires options 9 and 10) |
| JD748A042 | GSM/GPRS/EDGE OTA Analyzer ² | (Requires options 9 and 10) |
| JD748A043 | WCDMA/HSDPA OTA Analyzer ² | (Requires options 9 and 10) |
| JD748A045 | TD-SCDMA OTA Analyzer ² | (Requires options 9 and 10) |
| JD748A046 | Mobile WiMAX OTA Analyzer ² | (Requires options 9 and 10) |
| JD748A048 | LTE OTA - FDD Analyzer ² | (Requires options 9 and 10) |
| JD748A049 | LTE OTA - TDD Analyzer ² | (Requires options 9 and 10) |

¹Highly recommended adding JD748A010

²Highly recommended adding G70005035x and/or G70005036x

Standard Accessories

| | |
|------------|---|
| G710550326 | AC/DC Power Adapter ³ |
| G710550335 | Cross LAN Cable (1.5 m) ³ |
| GC73050515 | USB A to B Cable (1.8 m) ³ |
| GC72450518 | > 1 G Byte USB Memory ³ |
| G710550325 | Rechargeable Lithium Ion Battery ³ |
| G710550323 | Automotive Cigarette Lighter 12 VCD Adapter ³ |
| JD740A361 | JD740A Series User's Manual and Application Software – CD |

³Standard accessories can be purchased separately.

JD740A Series Common Options

Optional RF Power Sensors

| | |
|---------------|---|
| JD731A/JD731B | Directional Power Sensor (peak and average power) Frequency: 300 MHz to 3.8 GHz Power: Average 0.15 to 150 W, Peak 4 to 400 W |
| JD733A | Directional Power Sensor (peak and average power) Frequency: 150 MHz to 3.5 GHz Power: Average/Peak 0.1 to 50 W |
| JD732A | Terminating Power Sensor (average power) Frequency: 20 MHz to 3.8 GHz Power: -30 to +20 dBm |
| JD734A | Terminating Power Sensor (peak power) Frequency: 20 MHz to 3.8 GHz Power: -30 to +20 dBm |
| JD736A | Terminating Power Sensor (peak and average power) Frequency: 20 MHz to 3.8 GHz Power: -30 to +20 dBm |

Optional Optical Power Sensors

| | |
|-------|---|
| MP-60 | Miniature USB 2.0 Optical Power Sensor Wavelength range: 780 to 1650 nm 1300, 1310, 1490, 1550 nm: -50 to +10 dBm 850 nm: -45 to +10 dBm |
| MP-80 | Miniature USB 2.0 Optical Power Sensor Wavelength range: 780 to 1650 nm 1300, 1550 nm: -35 to +23 dBm 850 nm: -30 to +23 dBm |

Optional Calibration Kits

| | |
|------------|---|
| JD72450509 | Y - Calibration Kit, Type-N(m), DC to 4 GHz, 50 W |
| JD72450510 | Y - Calibration Kit DIN(m), DC to 4 GHz, 50 W |
| JD71050507 | Dual Port Type-N Calibration Kit, 50 W <ul style="list-style-type: none"> - Y - Calibration Kit, Type-N(m), DC to 4 GHz, 50 W - Two Adapters Type-N(f) to Type-N(f), DC to 4 GHz, 50 W - Two 1 m RF Test Cables, Type-N(m) to Type-N(m), DC to 18 GHz, 50 W |
| JD71050508 | Dual Port DIN Calibration Kit, 50 W <ul style="list-style-type: none"> - Y - Calibration Kit DIN(m), DC to 4 GHz, 50 W - Two 1 m RF Test Cables, Type-N(m) to Type-N(m), DC to 18 GHz, 50 W - Adapter Type-N(f) to DIN(f), DC to 4 GHz, 50 W - Adapter Type-N(f) to DIN(m), DC to 4 GHz, 50 W - Adapter DIN(f) to DIN(f), DC to 4 GHz, 50 W - Adapter DIN(m) to DIN(m), DC to 4 GHz, 50 W |

Optional RF Cables

| | |
|------------|--|
| G710050530 | 1.0 m (3.28 ft) RF Cable, DC to 18 GHz, Type-N(m) to Type-N(m), 50 W |
| G710050531 | 1.5 m (4.92 ft) RF Cable, DC to 18 GHz, Type-N(m) to Type-N(f), 50 W |
| G710050532 | 3.0 m (9.84 ft) RF Cable, DC to 18 GHz, Type-N(m) to Type-N(f), 50 W |

Optional Omni Antennas

| | | |
|------------|-----------------|-----------------------------|
| G700050351 | RF Omni Antenna | Type-N(m), 400 to 450 MHz |
| G700050352 | RF Omni Antenna | Type-N(m), 450 to 500 MHz |
| G700050353 | RF Omni Antenna | Type-N(m), 806 to 896 MHz |
| G700050354 | RF Omni Antenna | Type-N(m), 870 to 960 MHz |
| G700050355 | RF Omni Antenna | Type-N(m), 1710 to 2170 MHz |
| G700050356 | RF Omni Antenna | Type-N(m), 720 to 800 MHz |

Optional Yagi Antennas

| | | |
|------------|-----------------|--------------------------------------|
| G700050364 | RF Yagi Antenna | Type-N(f), 806 to 896 MHz, 10.2 dBd |
| G700050365 | RF Yagi Antenna | Type-N(f), 866 to 960 MHz, 10.2 dBd |
| G700050363 | RF Yagi Antenna | Type-N(f), 1750 to 2390 MHz, 9.8 dBd |

Optional Adapters

| | |
|------------|---|
| G710050571 | Adapter Type-N(m) to DIN(f), DC to 4 GHz, 50 W |
| G710050572 | Adapter DIN(m) to DIN(m), DC to 4 GHz, 50 W |
| G710050573 | Adapter Type-N(m) to SMA(f), DC to 18 GHz, 50 W |
| G710050574 | Adapter Type-N(m) to BNC(f), DC to 1.5 GHz, 50 W |
| G710050575 | Adapter Type-N(f) to Type-N(f), DC to 4 GHz, 50 W |
| G710050576 | Adapter Type-N(m) to DIN(m), DC to 4 GHz, 50 W |
| G710050577 | Adapter Type-N(f) to DIN(f), DC to 4 GHz, 50 W |
| G710050578 | Adapter Type-N(f) to DIN(m), DC to 4 GHz, 50 W |
| G710050579 | Adapter DIN(f) to DIN(f), DC to 4 GHz, 50 W |

Optional E1/T1 Test Cables

| | |
|------------|---------------------------|
| G710050317 | RJ45 to Y Bantam Cable |
| G710050318 | RJ45 to Y BNC Cable |
| G710050319 | RJ45 to 4 Alligator Clips |

Optional Miscellaneous

| | |
|------------|--|
| G710050581 | Attenuator 40 dB, 100 W, DC to 4 GHz (Unidirectional) |
| JD74050341 | JD740 Soft Carrying Case |
| JD71050342 | JD7100/JD740 Hard Carrying Case |
| JD74050343 | JD740 Backpack Carrying Case |
| G710050585 | Wide Band Coupler, 700 to 4000 MHz, 30 dB ¹ |
| G710050586 | Wide Band Combiner, 700 to 4000 MHz ¹ |
| G710550324 | External Battery Charger |
| JD740A362 | JD745A User's Manual – Printed Version |

¹Highly recommended items for LTE Testing



Test & Measurement Regional Sales

NORTH AMERICA

Tel: +1 866 228 3762
Fax: +1 301 353 9216

LATIN AMERICA

Tel: +55 11 5503 3800
Fax: +55 11 5505 1598

ASIA PACIFIC

Tel: +852 2892 0990
Fax: +852 2892 0770

EMEA

Tel: +49 7121 86 2222
Fax: +49 7121 86 1222

