

MG3700A

Vector Signal Generator

250 kHz to 3 GHz, 250 kHz to 6 GHz (Option)





Supporting High-speed, Large-capacity, and Wideband Wireless Communications

Wireless communications are evolving rapidly towards high speed, large capacity and wide bandwidth.

And next-generation wireless communications will combine cellular phone service with wireless LAN access.

The MG3700A Vector Signal Generator is based on a 160-MHz arbitrary waveform generator, including a wide vector modulation bandwidth and large-capacity baseband memory.

The MG3700A supports digital modulation signals for a wide range of wireless systems, supporting evaluation of general-purpose mobile communications, such as mobile phones as well as wireless LANs. Anritsu's IQproducer software can create waveform data for transfer to the MG3700A via 100BASE-TX Ethernet. In addition, IQ sample data files (ASCII) created using general Electronic Design Automation (EDA) tools such as MATLAB can also be converted to waveform patterns for the MG3700A.

MATLAB® is a registered trademark of The MathWorks, Inc.

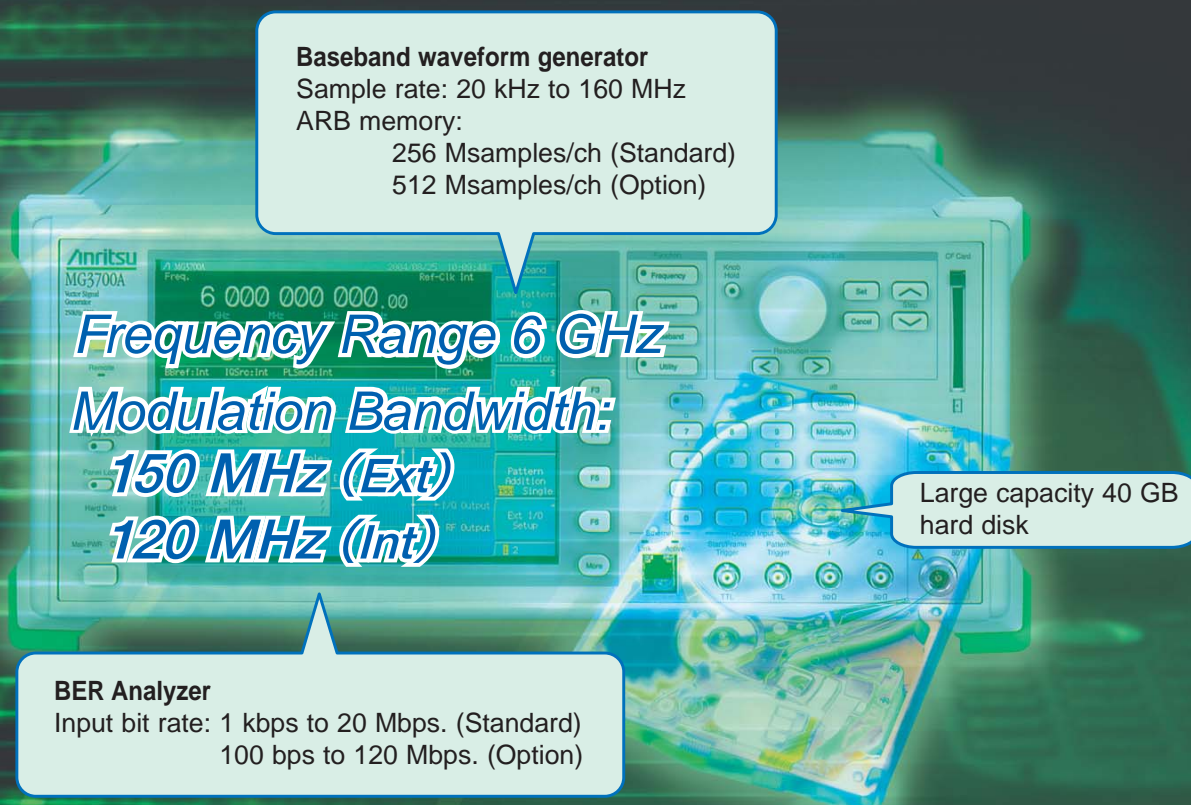

Baseband waveform generator
 Sample rate: 20 kHz to 160 MHz
 ARB memory:
 256 Msamples/ch (Standard)
 512 Msamples/ch (Option)

Frequency Range 6 GHz
Modulation Bandwidth:
150 MHz (Ext)
120 MHz (Int)

Large capacity 40 GB hard disk

BER Analyzer
 Input bit rate: 1 kbps to 20 Mbps. (Standard)
 100 bps to 120 Mbps. (Option)

■ Performance and Functions

- **Frequency Range**
 250 kHz to 3 GHz (Standard)
 250 kHz to 6 GHz (Option)
- **Wide Vector Modulation Bandwidth**
 120 MHz (Internal baseband generator)
 150 MHz (External IQ input)
- **High Level Accuracy**
 ±0.5 dB (Absolute level accuracy)
 ±0.2 dB typical (Linearity)
- **High-speed Waveform Transfer over 100BASE-TX Ethernet**
- **Built-in 40 GB Hard Disk**
- **Large-capacity Baseband Memory**
 1 GB = 256 Msamples/channel (Standard)
 2 GB = 512 Msamples/channel (Option)
- **Waveform Addition Function**
 Adds and outputs two signals, such as wanted signal + interference signal or wanted signal + AWGN
- **Built-in Standard 20-Mbps BERT Analyzer**
 1 kbps to 20 Mbps (Standard)
 100 bps to 120 Mbps (Option)

■ Supports Various Communication Systems*1

- **Waveform Patterns**
 Waveform patterns for communication systems bundled as standard:
 W-CDMA/HSDPA, GSM/EDGE, CDMA2000 1X/1xEV-DO, Wireless LAN (IEEE802.11a/b/g), PDC, PHS, AWGN, Bluetooth, GPS, Digital Broadcast (ISDB-T1 segment, BS, CS, CATV)
- **Optional Waveform Patterns**
 Waveform patterns for the following communication systems are offered as options:
 TD-SCDMA
 Public Radio System (RCR STD-39, ARIB STD-T61/T79/T86)
- **IQproducer Waveform Generation Software (Optional software license)**
 IQproducer is GUI-based PC application software for changing parameters and generating waveform patterns in compliance with the following system standards:
 W-CDMA, AWGN
 HSDPA/HSUPA*2, TDMA*2, CDMA2000 1xEV-DO*2, Multi-carrier*2, Mobile WiMAX*2, DVB-T/H*2, Fading*2, LTE*2

*1 Read the MX370x Series Software Catalog for details.
 *2 A license key must be installed in the main frame.

- CDMA2000® is a registered trademark of the Telecommunications Industry Association (TIA-USA).
- Bluetooth® and related logomarks are owned by Bluetooth SIG, Inc. and are used by Anritsu under license.
- Other companies, product names and service names are registered trademarks of their respective companies.

Easy-to-use Panel

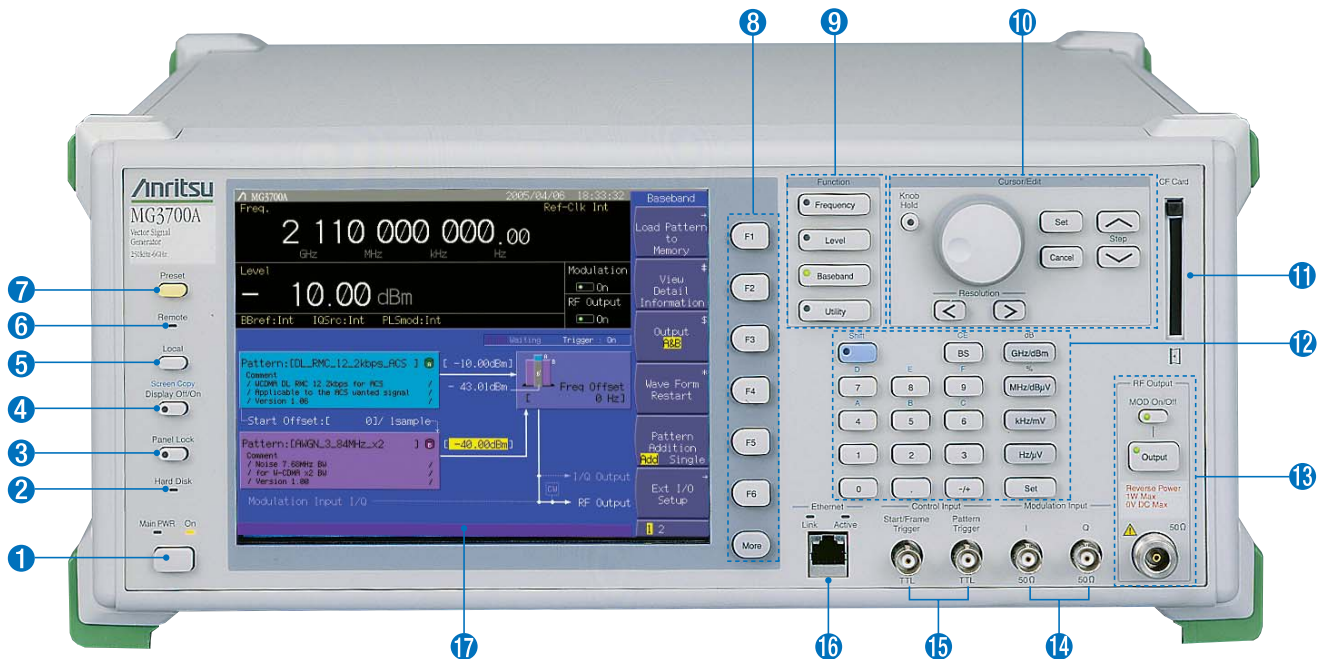

- 1 Main PWR key**
Switches power On/Off. When power is supplied, the lamp lights green. The On lamp lights orange at power-on.
- 2 Hard Disk lamp**
The lamp lights when the hard disk is being accessed.
- 3 [Panel Lock] key**
Disables all key operations except [Main PWR] and [Local]. The key lamp lights red when the panel is locked.
- 4 Display Off/On key**
Switches display On/Off. The key lamp lights red when the display is off.
- 5 [Local] key**
Disables remote control by GPIB and Ethernet and allows local control only.
- 6 Remote lamp**
Lights during remote control via GPIB and Ethernet
- 7 [Preset] key**
Initializes parameters
- 8 Function Keys ([F1] to [F6] and [More])**
Select and execute menu displayed on right of screen. When there are two or more screens, additional pages are displayed using the [More] key.
- 9 Function key group**
Change modes for setting equipment main functions
[Frequency]: Frequency setting mode
[Level]: Output level setting mode
[Baseband]: Baseband setting mode
[Utility]: Utility setting mode
- 10 Cursor/Edit key group**
Select items or input numerical settings
[Set]: Confirms selection
[Cancel]: Cancels selection
(The rotary encoder is disabled when the [Knob Hold] key is pressed and the key lamp is on.)
- 11 CF Card slot**
Slot for memory card for installing waveform patterns or software, and for saving screen displays
- 12 Keypad**
[Shift]: Enables key functions described above keys in blue letters when key lamp lit
[Numeric keys]: Input numeric settings
[Unit keys]: Set unit after numeric input
- 13 RF Output key group and connector**
[Output]: Switches RF signal output On/Off. Key lamp is lit when RF output is active
[MOD On/Off]: Turns modulation On/Off when RF signal output is enabled. Key lamp is lit when signal modulation is active
[RF Output connector]: RF signal output (N-J, 50 Ω)
- 14 Modulation Input connectors**
Connectors for I/Q input signal when external baseband signal is used for vector modulation (BNC-J, 50 Ω, Input voltage range ± 5 Vpeak)
- 15 Control Input connectors**
Connectors for start trigger, frame trigger and pattern trigger signals (BNC-J, TTL, reverse polarity of rising/falling edges supported)
- 16 Ethernet jack (RJ45)**
100BASE-TX connector for connecting PC via LAN when using remote control or transferring waveform patterns. When using this connector, jumper the two Ethernet connectors on the rear panel using the supplied straight-through LAN cable (Category 5).
- 17 Display**
8.4-inch, 640 x 480 dots, color TFT LCD
Screen dump saved to built-in hard disk or CF card as color or gray-scale bitmap file

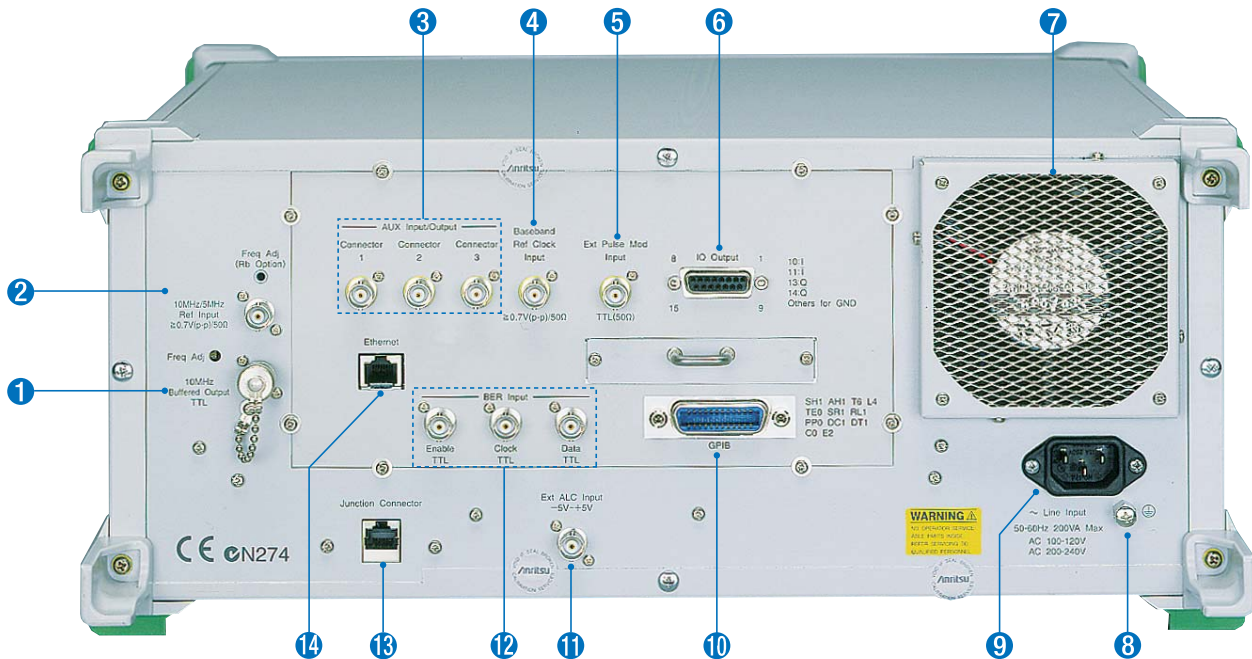

1 Buffered Output connector

Outputs 10-MHz reference frequency for synchronizing with other equipment (BNC-J, TTL, DC-coupled)

2 Ref Input connector

Input for external reference frequency signal (10 MHz or 5 MHz) when higher accuracy than the internal reference can provide is required or when synchronizing with the reference signal of other equipment (BNC-J, ≥ 0.7 Vp-p/50 Ω , AC-coupled)

3 AUX Input/Output connectors

Output for marker signal (BNC-J 3 port, TTL)

4 Baseband Ref Clock Input connector

Input for clock signal reference for D/A sampling clock (BNC-J, ≥ 0.7 Vp-p/50 Ω , AC-coupled, Input frequency range from 20 kHz to 160 MHz)

5 Ext Pulse Mod Input connector

Input for external pulse modulation signal (BNC-J, 50 Ω , Input voltage range from 0 to 5 V, Threshold of about 1 V)

6 IQ Output connector

Differential output of baseband signal (I/Q) generated by arbitrary waveform generation function (D-Sub 15-J, 50 Ω). Converted to BNC using optional IQ Output Conversion Adapter.

7 Cooling fan

Equipment cooling fan

8 Protective ground terminal

Ground when not using grounded power cord

9 AC input connector

AC power input

10 GPIB connector

For remote control by GPIB

11 Ext. ALC Input connector

External DC voltage input for controlling output level (+3 to -8 dB, BNC-J, 600 Ω , Input voltage range ± 5 V)

12 BER Input connectors

For BER measurements

Enable TTL: BER measurement gate signal input

Clock TTL: Input for clock signal synchronized with data

Data TTL: Data input (BNC-J, TTL)

13 Junction connector (RJ45 jack)

When using the front-panel Ethernet jack, jumper this Junction connector and the Ethernet jack above using the supplied straight-through LAN cable (Category 5)

14 Ethernet jack (RJ45)

Ethernet jack for connecting PC when performing remote control or transferring waveform pattern.

This jack can be used instead of the Ethernet jack on the front panel.

Basic Performance

Covers Frequency Range from 250 kHz to 6 GHz

Choose a frequency range of either 250 kHz to 3 GHz (standard) or 250 kHz to 6 GHz (Option). The upper 6 GHz frequency is required for supporting WLANs in the 5-GHz band and next-generation communication systems.

High Level Accuracy

The excellent level accuracy assures a high overall measurement accuracy.

Absolute level accuracy:

± 0.5 dB typ (≥ -120 dBm $25 \text{ MHz} \leq f_c \leq 3 \text{ GHz}$, E-ATT*)

± 0.8 dB typ (≥ -120 dBm $3 \text{ GHz} < f_c \leq 6 \text{ GHz}$, E-ATT*)

± 0.5 dB typ (≥ -120 dBm $25 \text{ MHz} \leq f_c \leq 3 \text{ GHz}$, M-ATT*)

± 0.8 dB typ (≥ -100 dBm $3 \text{ GHz} < f_c \leq 6 \text{ GHz}$, M-ATT*)

* E-ATT: Electronic attenuator, M-ATT: Mechanical attenuator

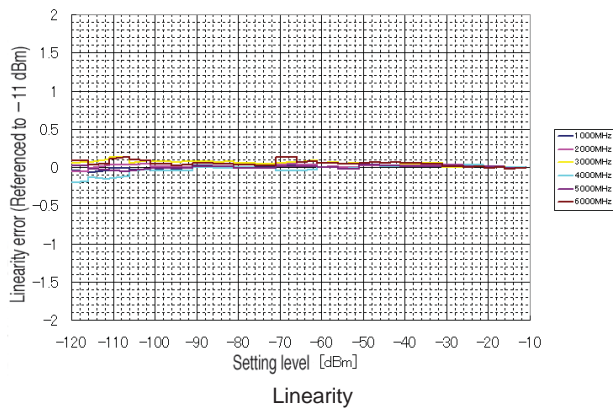
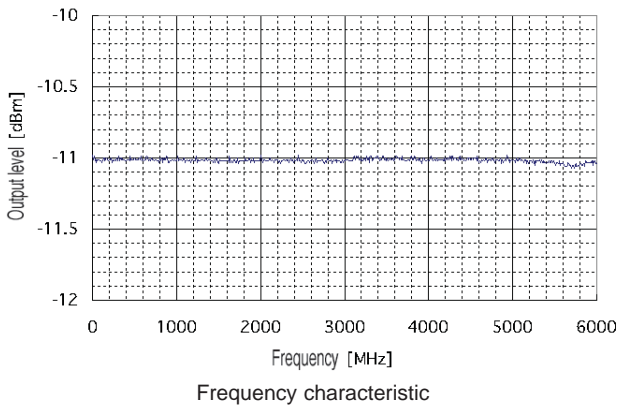

Wide Vector Modulation Bandwidth

120 MHz (Using internal baseband signal generator)
150 MHz (Using External IQ input)

An RF modulation bandwidth of 120 MHz is available when using internal baseband signal generation.

The modulation bandwidth of 150 MHz can be achieved when using external IQ input.

Both bandwidths are supported up to 6 GHz.

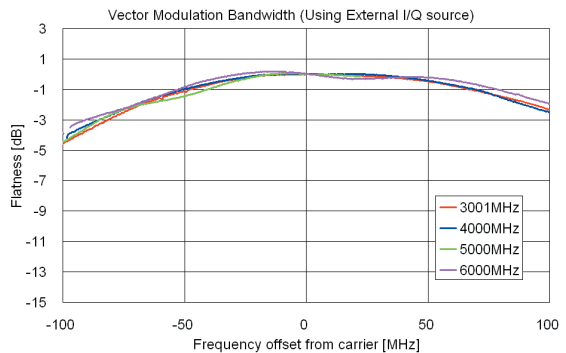
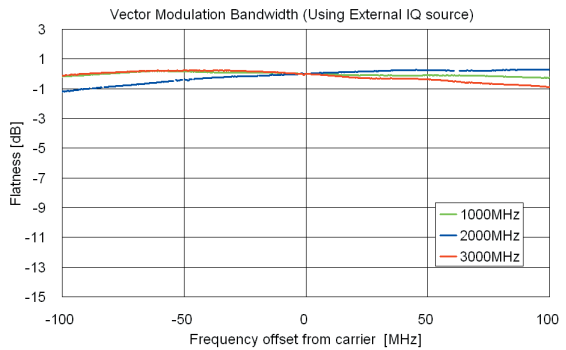
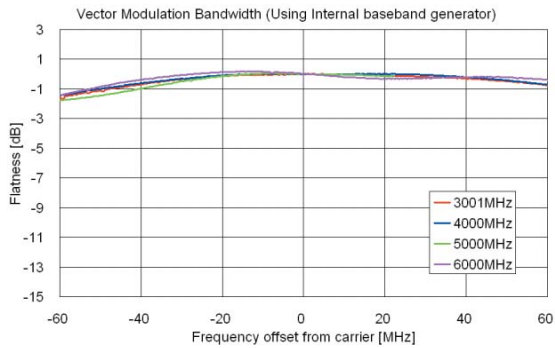
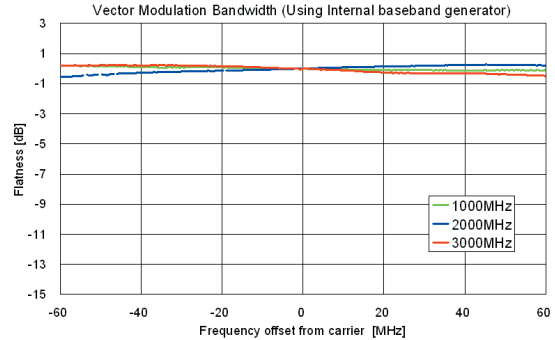

Vector Modulation Bandwidth (Using external IQ input)

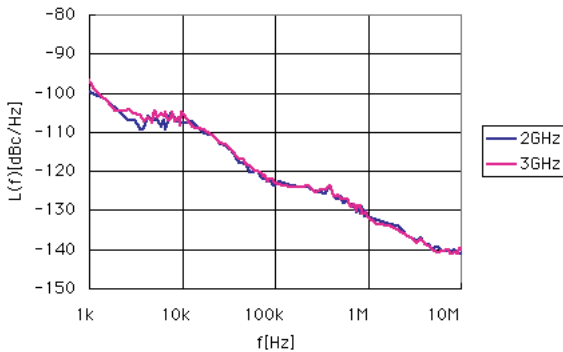

SSB Phase Noise ($25 \text{ MHz} \leq f \leq 3 \text{ GHz}$)
(CW, Continuous mode: OFF, Frequency changing speed: Normal)

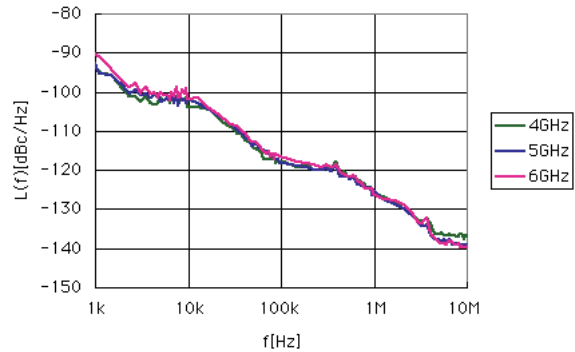

SSB Phase Noise ($3 \text{ GHz} < f \leq 6 \text{ GHz}$)
(CW, Continuous mode: OFF, Frequency changing speed: Normal)

Supports Large-capacity Waveform Patterns

High-speed Transfer over 100BASE-TX Ethernet

Wideband high-speed communication systems require transmission of long waveform patterns.

To transfer long patterns at high speed, the MG3700A supports 100BASE-TX LAN connections.

When the waveform patterns of two or more MG3700A systems must be updated, waveform data can be transferred simultaneously to all MG3700A units over the LAN, shortening update times.

- High-speed transmission of waveform patterns at 2 MB/s
- Waveform patterns transferred to MG3700A from external PC saved to built-in 40 GB hard disk
- Ethernet jacks on the front and rear panels for easy LAN connection

Built-in 40 GB Hard Disk

Various large-capacity waveform patterns and MG3700A parameters can be saved the built-in 40 GB hard disk.

The transfer speed between the hard disk and waveform memory is fast (14 MB/s typ).

If the hard disk fails, it can be changed using the optional HDD ASSY.

Up to 2 GB Waveform Memory 1 GB = 256 Msamples/channel (Standard) 2 GB = 512 Msamples/channel (Option)

The large-capacity waveform memory can save many waveform patterns.

Waveform patterns are read from the hard disk and saved to memory for instant output without accessing the hard disk again.

The standard MG3700A waveform memory can save up to 256 Msamples/channel (128 Msamples/channel x 2).

This memory can be expanded to 512 Msamples/channel (256 Msamples/channel x 2) as an option.

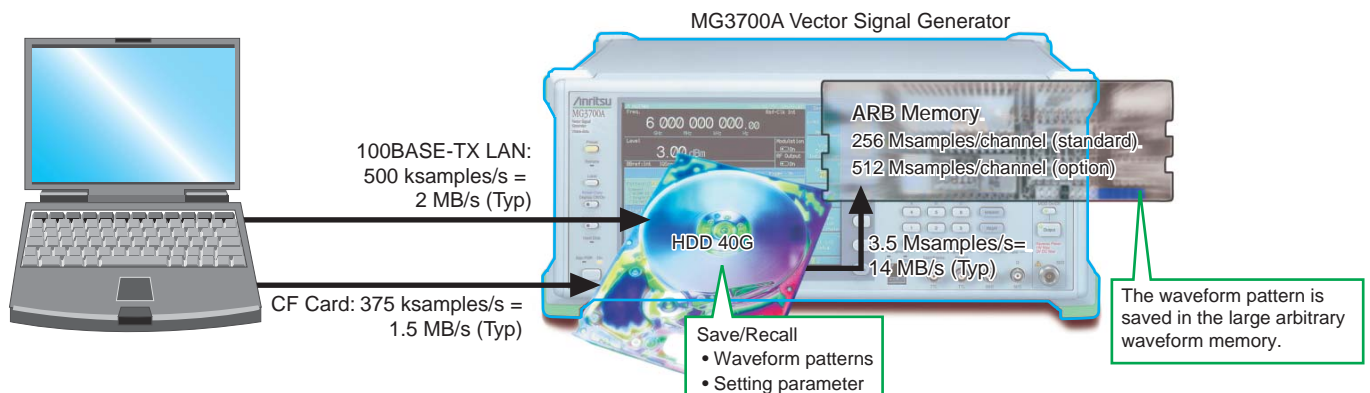

Useful Standard Functions

Waveform Combining Function

The MG3700A has two built-in arbitrary waveform memories, each of which can hold one waveform pattern.

The MG3700A can output a signal from either memory, as well as combine and output both signals simultaneously.

When measuring receiver characteristics, such as Adjacent Channel Selectivity (ACS) or Blocking characteristics, one MG3700A can output both the Wanted Signal and the Interfering Signal or the Wanted Signal with AWGN.

Digital signal processing ensures excellent level accuracy.

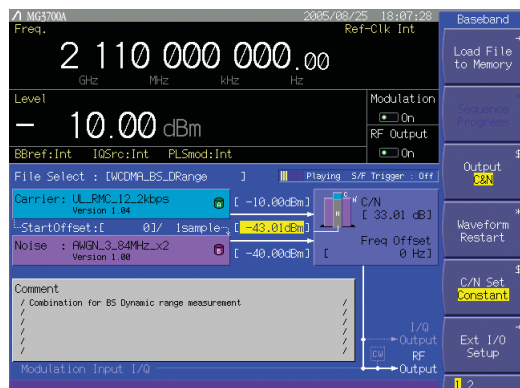

Wanted Signal + AWGN Screen

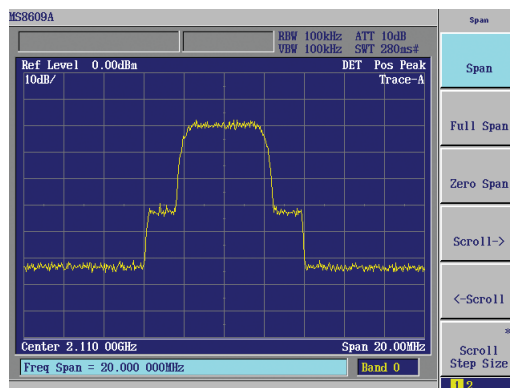

Output Waveform Screen

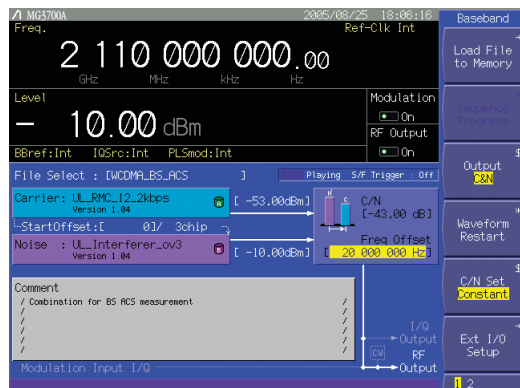

Wanted Signal + Interference Signal Screen

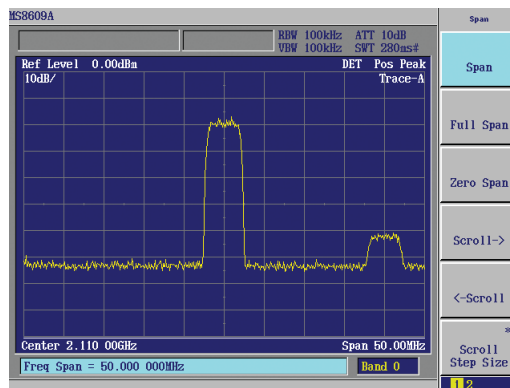

Output Waveform Screen

Combination file

The Combination function makes the work of waveform addition even easier. It uses a file in which various parameters, such as the pattern file for the two waveform memories, the output level ratio, and the offset frequency, are pre-defined.

When selected, the values for these parameters are automatically set in the MG3700A.

Steps without Combination function

- Processing required waveform + interference waveform
 - Set required waveform in memory A.
 - Set interference waveform in memory B.
 - Set level of required waveform.
 - Set level of interference waveform.
 - Set offset frequency of required and interference waveforms.
- Processing W-CDMA control CH + Data CH
 - Set Control CH in memory A.
 - Set Data CH in memory B.
 - Set level of Control CH.
 - Set level of Data CH.

Effect of Combination function

- Select the Combination file.
- Parameters are automatically set.
- Waveforms are ready to be generated.

Sequence Mode

The Sequence Mode Combination function saves operating parameters, such as the waveform pattern repetition times, waveform pattern switching, and output level settings, to a file. Simply selecting this file performs these operations automatically.

Steps without Sequence mode

- Create a single waveform pattern combining the required waveform pattern type and times, and save it in memory.
- Create a new waveform pattern when the repetition time changes.

Effect of Sequence mode

The required waveform pattern and combination file are saved in memory. Moreover, an external trigger can be used to repeat each waveform pattern any number of times.

- ⇒ Makes efficient use of memory
- ⇒ Permits investigation of response status transitions
- ⇒ Enables manual sequence control

This is very convenient when investigating state transitions in response to received signals, such as during connection procedures.

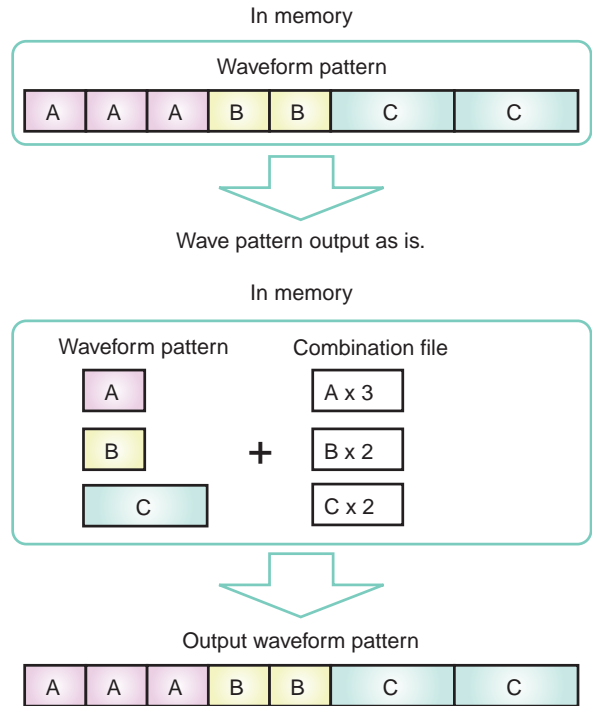

Built-in Standard 20 Mbps BER

The built-in BER analyzer supports easy BER measurement.
 Input bit rate: 1 kbps to 20 Mbps
 Measurable BER: 0 to 1%
 A BER option supports measurement from 100 bps to 120 Mbps (next page).

This function is used by connecting the signal demodulated by the DUT to the Enable/Clock/Data BNC connectors on the rear panel.

In addition, up to 100 BER measurement results can be logged in a file containing test information, including measurement time and date, error rate, bit count, termination cause, and measurement mode.

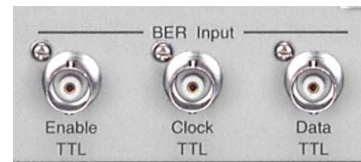

Rear-panel Connectors



BER Measurement Screen

Count mode	Standard BER Measurement Function	MG3700A-031/131 High speed BER Test Function
Time	✓	
DataBit/Data	✓	✓
Error		✓

Note: The Time setting, available in the Standard Measurement Function, is not available in the optional MG3700A-031/131 High-speed BER Test Function.

Options

Hardware Options

Model: MG3700A-001

Name: Rubidium Reference Oscillator

This option provides a 10 MHz reference signal VCO.
The frequency stability is better than the standard VCO.
Frequency: 10 MHz
Aging rate: $\pm 1 \times 10^{-10}$ /month
Temperature stability: $\pm 1 \times 10^{-9}$ (0° to $+50^\circ\text{C}$)

Model: MG3700A-002

Name: Mechanical Attenuator

This option changes the standard electronic attenuator to a mechanical attenuator, improving the maximum permissible output level and distortion characteristics.
Settable range: -140 to $+19$ dBm
Accuracy range (CW): -140 to $+10$ dBm

Model: MG3700A-011

Name: Upper Frequency 6 GHz

This option extends the upper frequency to 6 GHz from 3 GHz.

Model: MG3700A-021

Name: ARB Memory Upgrade 512 Msamples

This option extends the memory capacity of the ARB unit to 256 Msamples/channel x 2 from 128 Msamples/channel x 2.

Model: MG3700A-031

Name: High-speed BER Test function

This option upgrades the standard built-in BER measurement functions as follows:

- Increases the data rate to a range of 100 bps to 120 Mbps
- Added SyncLoss count function
- Added discontinuous PN data measurement function
- Added user pattern measurement function

Comparison between Standard BER Measurement Function and Option BER Measurement Function

		Standard BER Measurement Function (ver.02 or later)	MG3700A-031/131 High-speed BER Test Function	Case
On/Off function of Auto Resync		✓	✓ + Threshold adjustment	Can perform continuous measurement of high error rates by changing measurement conditions to match error rates. Auto Resync = OFF is required for manufacturing inspection of some communications systems requiring reception sensitivity with BER=1%, and for R&D applications that evaluate reception sensitivity limits.
Count Mode*	Time	✓		Measurement range can be set.
	DataBit/Data	✓	✓	
	Error		✓	
Measurement data rate upper limit	20 Mbps	120 Mbps		This can be used for WLAN and next-generation high-speed communications systems .
SyncLoss count function	—	✓		This can be used for continuous measurement even when synchronization loss occurs.
Measurement of discontinuous PN data	—		✓	When the size of continuous data such as ISDB-T PN23 exceeds the MG3700A memory capacity, measurement can be performed by reducing the memory requirements using discontinuous PN data.
User pattern measurement	—		✓	This can be used for measuring fixed patterns such as those specified by WiMAX .

*1: The measurement count of the standard BER measurement function (version 2.02 or earlier) could be set as Time and Number of bits. The High-speed BER Test Function option does not have the Time setting, and can set Number of bits and Number of error bits.

BER Measurement Variation Caused by Auto Resync On/Off

The figure below shows one example of a BER measurement that indicates SyncLoss. Actual results depend on the specific communication system and data rate, and will not necessarily match the measurement values below.

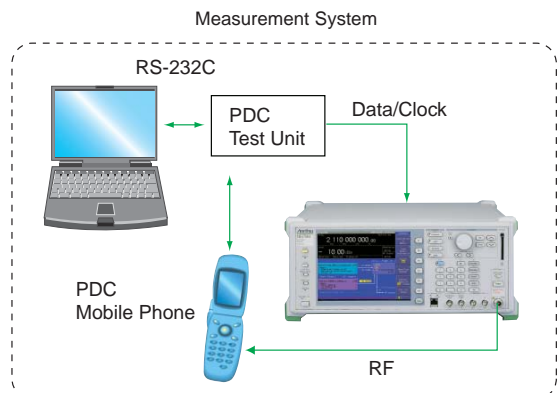
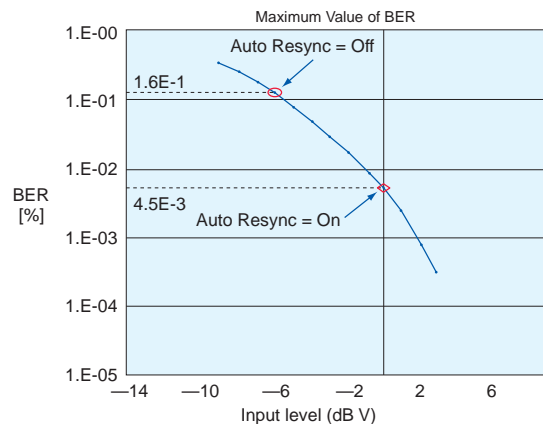

■ Software options: IQproducer License*

The IQproducer software can be installed on any PC for evaluation before purchase. To generate RF signals from the waveform pattern created by the IQproducer software, the MG3700A must be equipped with a license key for each of the technologies.

Model: MX370101A

Name: HSDPA/HSUPA IQproducer

Parameters can be changed and the required waveform patterns can be generated for HSDPA Uplink/Downlink and HSUPA E-DPDCH/EDPCCH.

Model: MX370102A

Name: TDMA IQproducer

Parameters can be changed and the required waveform patterns can be generated for TDMA system signals. The parameters that can be set include Modulation, Frame, Slot, Data, and Filter.

Model: MX370103A

Name: CDMA2000 1xEV-DO IQproducer

Parameters can be changed and the required waveform patterns can be generated for CDMA2000 1xEV-DO Forward/Reverse signals.

Model: MX370104A

Name: Multi-carrier IQproducer

The MX370104A Multi-carrier IQproducer software is GUI-driven PC application software for creating multi-carrier waveform patterns for the modulation and tone signals of various communication systems.

There is also a function for converting two waveform patterns with different sampling rates to a waveform pattern with one sampling rate, as well as a function for creating a waveform pattern with W-CDMA Downlink multi-carrier and clipping.

Model: MX370105A

Name: Mobile WiMAX IQproducer

Create UL and DL waveforms that comply with the IEEE 802.16e standard using a drop-and-drag GUI. Use these files wherever a mobile WiMAX signal is required. Test receivers per IEEE 802.16e standard section 8.4.13 - Receiver Requirements (excluding the tests that require test equipment other than a Signal Generator).

Model: MX370106A

Name: DVB-T/H IQproducer

The parameters for the ETSI EN 300 744 V1.5.1 (2004-11) Physical Layer specification are set and a waveform pattern is generated. A video file waveform pattern is generated by reading the user's MPEG-2 TS file. The generated waveform pattern can be used for the receiver sensitivity test using BER measurement and for the final operation check using the video.

Model: MX370107A

Name: Fading IQproducer

The MX370107A Fading IQproducer supports generation of faded waveform patterns (fading of each IQ channel, calculation of correlation line, addition of AWGN) by reading waveform patterns for the MG3700A.

Waveform patterns created by another IQproducer or IQ data (ASCII) created by general simulation tools can be selected as the input file.

The Channel Configuration can be selected from 1x1 SISO, 2x1 MISO, 1x2 SIMO, and 2x2 MIMO.

Model: MX370108A

Name: LTE IQproducer

The MX370108A LTE IQproducer supports creation of required waveform patterns by changing parameters standardized in the 3GPP LTE FDD specifications of 3GPP TS36.211, TS36.212, and TS25.814.

* Read the MX370x Series Software catalog for details.

Software options: Waveform pattern*

Waveform pattern options provide waveform data meeting the requirements of various communication systems and can be used by the MG3700A built-in arbitrary waveform generator. Waveform patterns are downloaded to the MG3700A for use.

Model: MX370001A

Name: TD-SCDMA Waveform Pattern

Waveform patterns for transmission/reception test of 3GPP 1.28 Mcps TDD Option (TD-SCDMA)

Model: MX370002A

Name: Public Radio System Waveform Pattern

Waveform patterns complying with RCR STD-39 and ARIB STD-T61/T79/T86*.

Waveform patterns, such as Uplink/Downlink and PN9/PN15 continuous waves.

RCR STD-39: Narrow band digital-communications system
 ARIB STD-T61: Narrow band digital-communications system
 ARIB STD-T79: Public digital-communications system
 ARIB STD-T86: Public digital-communications system

* Read the MX370x Series Software catalog for details.

Communication system		AWGN	W-CDMA	HSDPA (Test Model5)	HSDPA/HSUPA	CDMA2000 1xEV-DO	CDMA2000	GSM/EDGE	Advanced-PHS	PHS	PDC	ETC/DSRC	Digital Broadcast (BS/CS/CATV/ISDB-T)	Digital Broadcast (DVB-T/H)	WLAN (IEEE802.11a/b/g)	Mobile WiMAX (IEEE802.16e)	Bluetooth	GPS	TD-SCDMA	RCR STD-39	ARIB STD-T61/T79/T86	Multi-carrier	Fading	3GPP LTE (FDD)	
Waveform pattern	Preinstalled	✓	✓	✓		✓	✓	✓		✓	✓		✓		✓			✓							
	MX370001A TD-SCDMA																		✓						
	MX370002A Public Radio System																			✓	✓				
IQproducer	Standard accessories AWGN	✓																							
	Standard accessories W-CDMA		✓																						
	MX370101A HSDPA/HSUPA		✓		✓																				
	MX370102A TDMA								✓	✓	✓	✓								✓	✓				
	MX370103A CDMA2000 1xEV-DO					✓																			
	MX370104A Multi-carrier	Multi-carrier IQproducer is software that generates the multi-carrier signal based on waveform pattern of various telecommunications systems.																							
	MX370105A Mobile WiMAX															✓									
	MX370106A DVB-T/H													✓											
	MX370107A Fading	Fading IQproducer is software that generates the Fading signal based on waveform pattern of various telecommunication systems.																							
MX370108A LTE																								✓	

IQproducer Waveform Generation Software

Functions

IQproducer is PC application software used to generate waveform files. These files are then transferred to the MG3700A where they are used as the source of IQ data for modulated output.

It is bundled with MG3700A as standard and has the following four functions:

- Parameter setting
- Simulation
- File generation
- Data transfer

The IQproducer software can run on any PC that meets the operational requirements, however, a license must be installed on the MG3700A in order to play the files and produce a modulated RF signal.

IQproducer Operating Environment

CPU	Pentium III, 1 GHz or faster
Memory	≥ 512 MB
HDD	≥ 5 GB
Display	1024 x 768 pixels min.
OS	Windows 2000 Professional, Windows XP

Pentium® is registered trademarks of Intel Corporation or its subsidiaries in the USA and other countries.

Windows® is a registered trademark of Microsoft Corporation in the USA and other countries.

Parameter setting: System

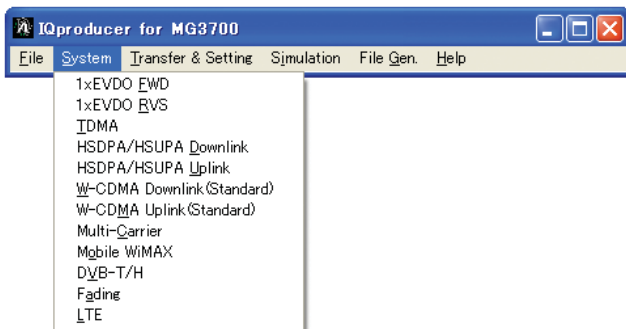

The IQproducer System function has a GUI for each communication system for easy parameter setting. Parameter settings can also be saved to a file and recalled.

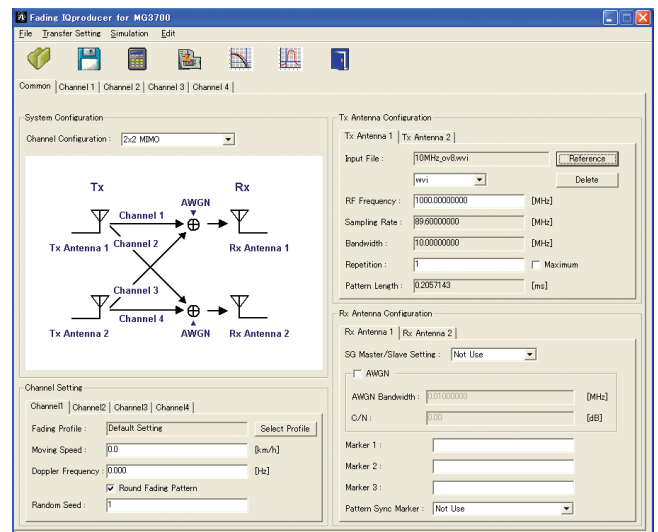

Fading IQproducer Setting Screen

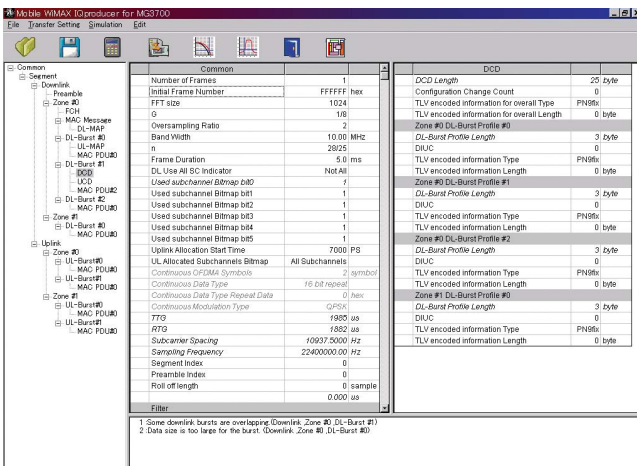

Mobile WiMAX IQproducer Setting Screen

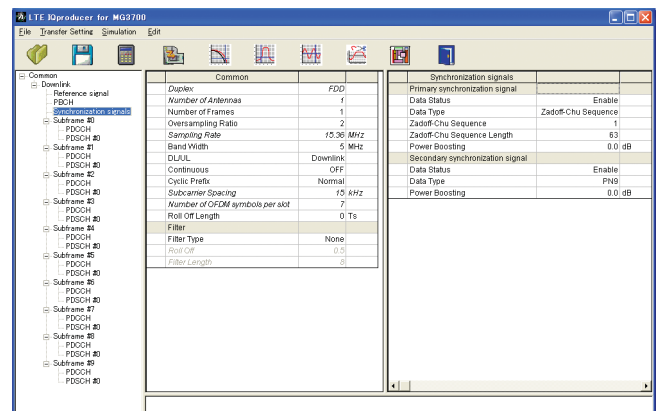

LTE IQproducer Setting Screen

Data transfer: Transfer and Setting

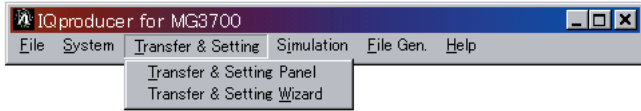

A PC and the MG3700A can be connected via 100BASE-TX Ethernet to transfer data such as a waveform pattern generated by IQproducer, firmware upgrade file, or graphics file. Waveform patterns can be transferred to multiple MG3700A units simultaneously when using a LAN connection. After the files are moved to the MG3700A, the IQproducer can remotely load the files into the waveform memory and select the appropriate file for playback.

Combination File generation

The Combination File Edit function is one of the Transfer & Setting Edit functions. The following parameters are set automatically by selecting the Combination File:

- Waveform pattern
- Repetition times
- Interference waveform pattern (Memory B)
- Frequency offset (Used when Memory A and Memory B are to be added)
- Level ratio (This value represents C/N when Memory A and Memory B are added, or the relative level between elements when only Memory A is used)

Using Combination Files that place the wanted signal waveform and the interference waveform into two separate memories makes it easy to measure receiver characteristics. Combination files can also be used to create sequences of waveforms. By using Sequence Mode Combination files in which switching and repetition times for multiple waveform patterns are defined, receive signal status transitions can be verified.

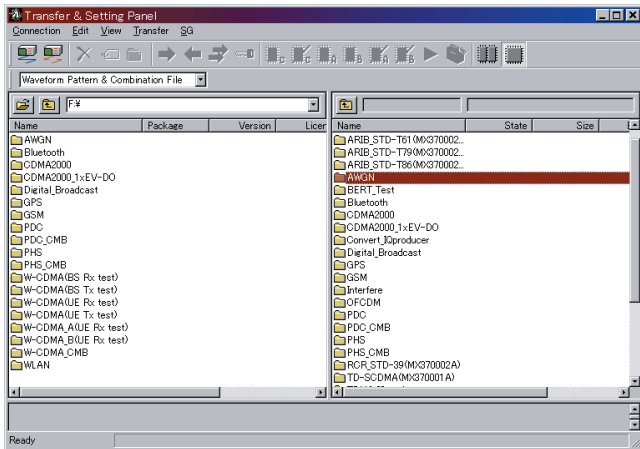

Transfer & Setting Screen

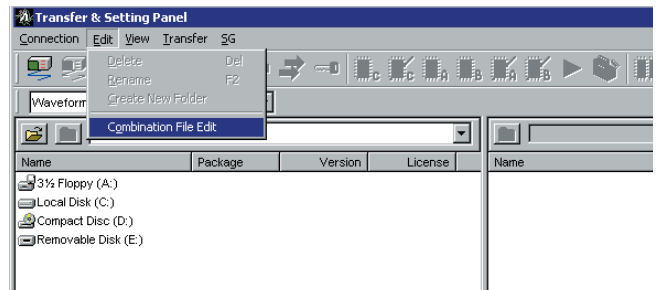

Transfer & Setting Screen

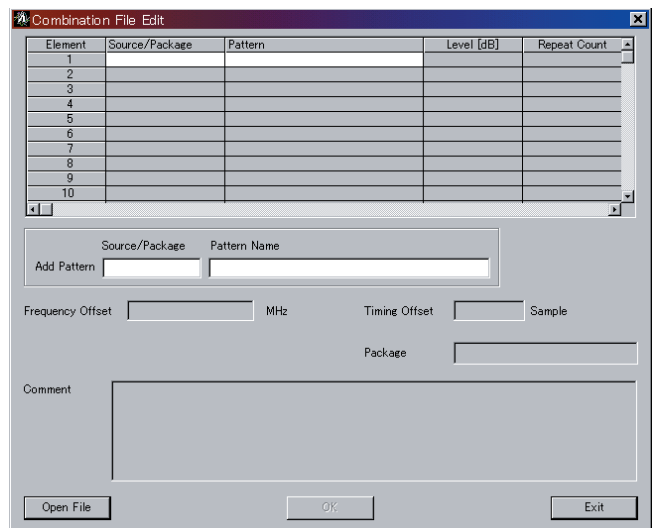

Combination File Edit Screen

• **Simulation: Simulation**

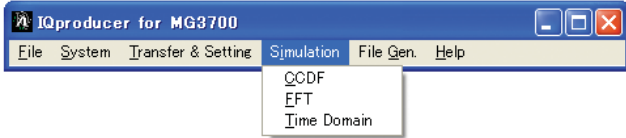

• **Graphical Simulation Displays**

This function displays a generated waveform as a Complementary Cumulative Distribution Function (CCDF), Fast Fourier Transform (FFT) and Time Domain graph on the PC. It is useful for checking or reviewing waveforms.

CCDF Graph

Up to eight generated waveform patterns can be read and displayed as CCDF graphs.

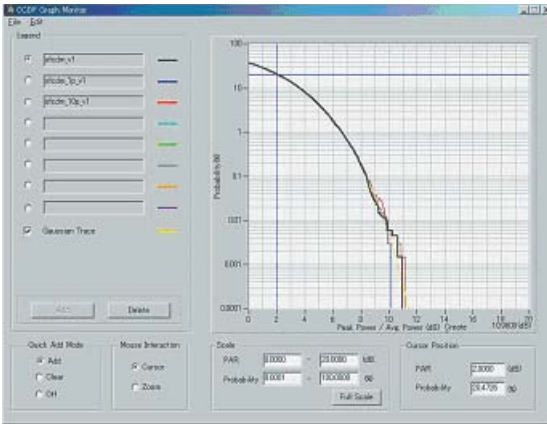

CCDF Graph

Time Domain Graph

Up to four generated waveform patterns can be read and displayed as a Time Domain graph.

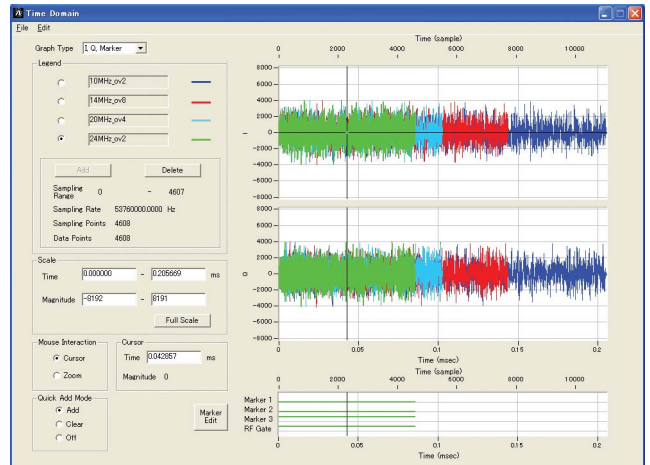

Time Domain Graph

FFT Graph

Up to four generated waveform patterns can be read and displayed as FFT graphs.

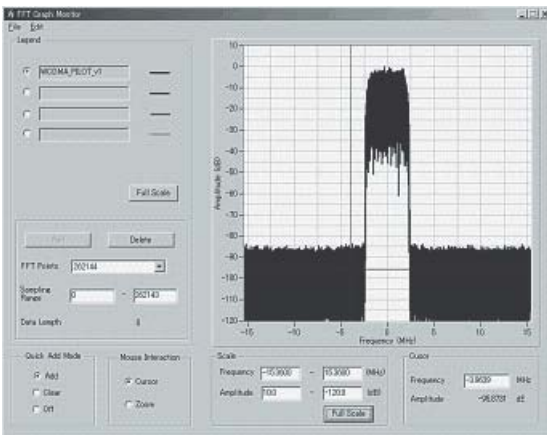

FFT Graph

• File generation: File Gen

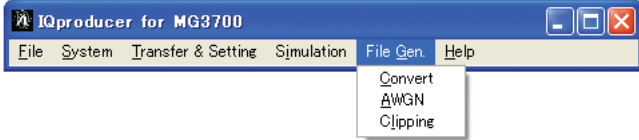

Convert: Data format conversion

ASCII-format IQ sample data created by general signal generation software (such as MATLAB) can be converted to waveform patterns for the MG3700A.

Data produced during R&D simulations can be converted using the IQproducer and moved to the MG3700A to produce signals that accurately reproduce the simulation data.

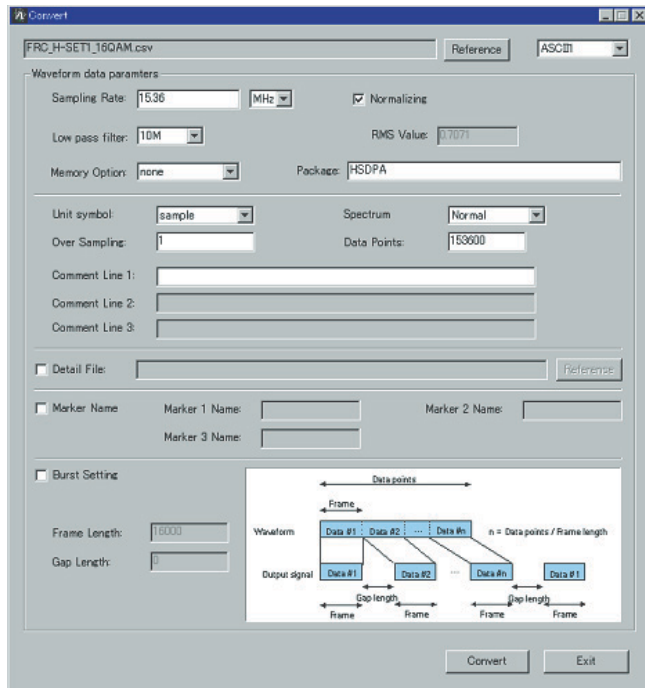

Convert Screen

Clipping

This function performs clipping of each type of waveform pattern. The clipped waveform pattern is created by setting the filter, bandwidth, and repetition times.

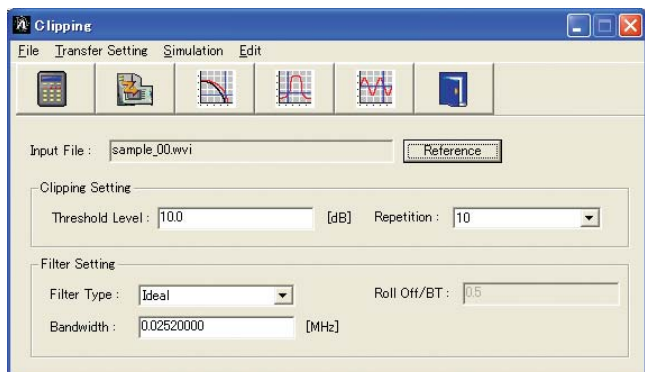

Clipping Graph

Additive White Gaussian Noise (AWGN) waveform generation

This function establishes the sampling rate and bandwidth, allowing any AWGN waveform pattern to be created.

In addition, when the first combined waveform pattern (Wanted Signal) is selected, the Wanted Signal bandwidth and sampling rate are set automatically.

The resulting AWGN waveform pattern can be combined with an existing waveform pattern, which is useful for base-station dynamic-range measurements.

Main setting parameters

- (1) Wanted Signal BW: Wanted Signal bandwidth
Setting range: 0.0010 to 120.0000 MHz
- (2) AWGN BW (B)/Wanted Signal BW (A):
Magnification of AWGN to Wanted Signal
Setting range: 1.0, 1.5, 2.0, 2.5
- (3) Sampling Rate:
Setting range: 0.0200 to 160.0000 MHz
Same value as Wanted Signal.
- (4) AWGN BW (B): Bandwidth of AWGN
Calculated automatically from (1) and (2) under following items:
Limit range: 0.001 to 20.000 MHz and Sampling rate/2 max.
20.001 to 120.000 MHz and Sampling rate max.

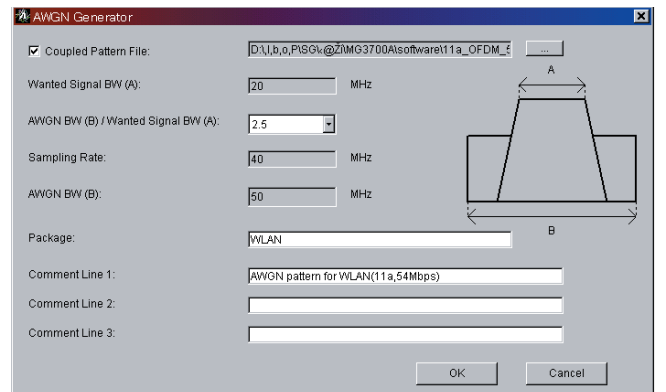

AWGN Screen

Measurement Sampling

Evaluating Receiver Characteristic for Base Station and UEs of Various Mobile Communications Systems

Because the MG3700A supports waveform patterns meeting the requirements of mobile communications systems and includes a built-in BER analyzer, it is ideal for measuring receiver characteristics. The waveform combination function can combine two waveform patterns, so a single MG3700A can output two signals, such as the Wanted signal + Interference signal or Wanted signal + AWGN (Additive White Gaussian Noise).



MG3700A Vector Signal Generator



Built-in BER Analyzer

Input bit rate: 1 kbps to 20 Mbps (Standard)
100 bps to 120 Mbps (Option)

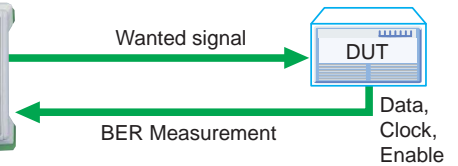

- The receiver sensitivity test covers BER measurement items.
Examples: W-CDMA, GSM, PHS, and PDC
- Since the built-in BER analyzer is a standard feature, a receiver test can be carried out easily without extra test equipment.

MG3700A Vector Signal Generator



Wanted signal + Interfering signal
Wanted signal + AWGN



The waveform combination function is built-in.

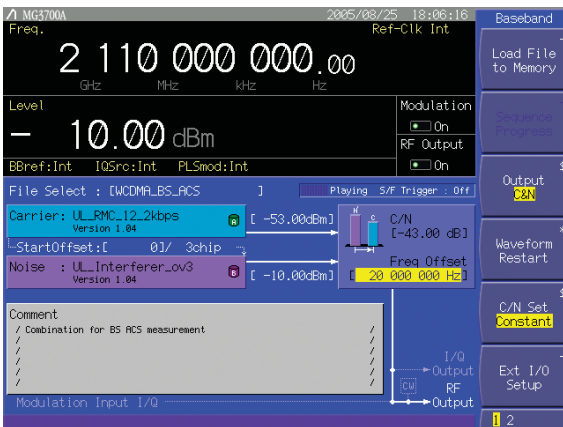

Wanted Signal + Interfering Screen

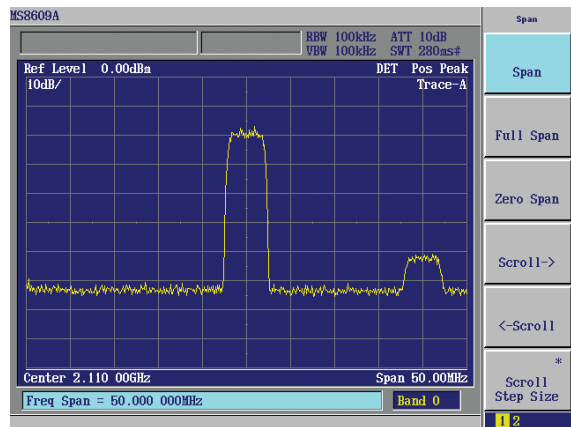

Output Waveform Screen

- The receiver sensitivity test covers measurements using two signals, such as Adjacent Channel Selectivity (ACS) and blocking characteristic.
- The waveform combination function enables one MG3700A to output a single RF signal containing the Wanted signal + Interfering signal or the Wanted signal + AWGN.
- The level ratio accuracy is excellent because S/N adjustment is performed by digital processing.

Evaluating Receiver Characteristics of Multi-Mode Wireless Devices

Multi-mode equipment that supports multiple wireless technologies is now common. Signal generators that can support multiple communication technologies are required for evaluating the receiver characteristics of this equipment. Besides the traditional receiver tests such as sensitivity and compression, additional testing must be done to ensure that the receiver characteristics of one technology are not degraded by the presence of a signal from another technology.

The MG3700A supports all major telecommunication modulation schemes. It can be used alone or as part of a system as shown below.

MT8820B Radio Communication Analyzer

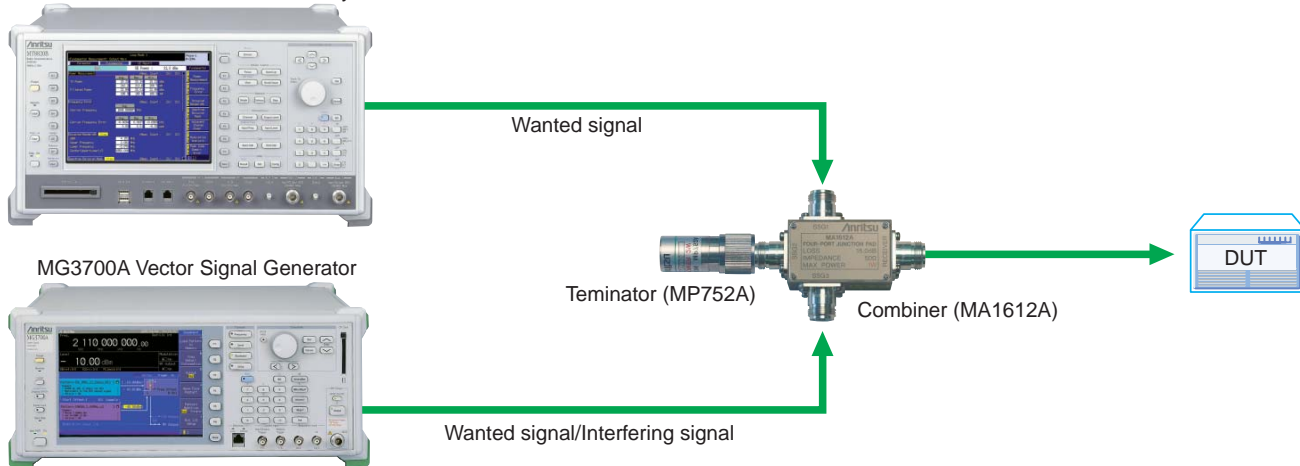

- One MG3700A can output the wanted signal for evaluating receiver characteristic of various communication systems.
- It can also be used to generate interference signal for evaluating degraded receiver characteristics caused by mutual interference.

Supports R&D of Evolving Communication Systems

The IQproducer data conversion function can be used to convert customized waveform files created common EDA tools. For example, an IQ sample data file simulated by MATLAB can be converted to the waveform pattern file used by the MG3700A, so the MATLAB simulation result can be compared with an actual measurement result.

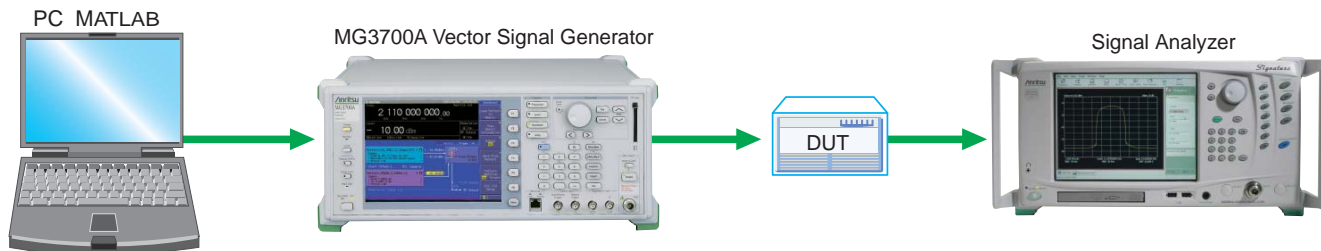

Specifications

● MG3700A Vector Signal Generator

The following conditions are applied unless otherwise specified. Common to CW mode and modulation mode. [Continuous mode: Off, External ALC: Off, Frequency switching speed: Normal, Pulse modulation: Off], Only during modulation mode [Input level to DAC (RMS): Full scale 14 dB to full scale 17 dB, Sampling rate: >100 kHz, Memory mode: Except combining two waveform, IQ Output: Off, After CAL execution, During internal modulation]

Frequency	Range	250 kHz to 3 GHz (Standard), 250 kHz to 6 GHz (Option)																																																						
	Resolution	0.01 Hz																																																						
	Internal reference oscillator	Frequency: 10 MHz, Aging rate: $\pm 1 \times 10^{-8}$ /day, $\pm 1 \times 10^{-7}$ /year, Temperature stability: $\pm 2 \times 10^{-8}$ (0° to +50°C), Start-up characteristics (at 23°C): $\pm 5 \times 10^{-8}$ (After 5 min, compared to frequency after 24 h warm-up) With Rubidium Reference Oscillator Option Frequency: 10 MHz, Aging rate: $\pm 1 \times 10^{-10}$ /Month, Temperature stability: $\pm 1 \times 10^{-9}$ (0° to +50°C), Start-up characteristics (at 23°C): $\pm 1 \times 10^{-9}$ (After 7 min, compared to frequency after 24 h warm-up)																																																						
	External reference input	Frequency: 5 MHz/10 MHz (auto-switching), Operating range: ± 1 ppm, Input level: ≥ 0.7 Vp-p/50 Ω (AC coupled), Connector: BNC-J (rear panel, Ref Input)																																																						
	Buffer output (Reference output)	Frequency: 10 MHz, Output level: TTL (DC-coupled), Connector: BNC-J (rear panel, Buffered Output)																																																						
	Switching time	Response time from final command to $\pm 0.1^*$ ppm of set frequency on GPIB * (When set frequency is 1 GHz or less, response time from final command to ± 100 Hz) When Frequency change speed = Normal: ≤ 40 ms (When exceeding 3 GHz) ≤ 15 ms (When the amount of frequency change is less than 1 GHz without exceeding 3 GHz) ≤ 20 ms (When the amount of frequency change is 1 GHz or more without exceeding 3 GHz) When Frequency change speed = Fast: ≤ 40 ms (When exceeding 3 GHz) ≤ 10 ms (When not exceeding 3 GHz) With Mechanical Attenuator Option Regardless of frequency change speed.: ≤ 100 ms (When exceeding 3 GHz) ≤ 80 ms (When not exceeding 3 GHz)																																																						
Frequency setup and Display	Direct setup: Absolute value of frequency is set up and displayed. Setup by CH: CH assigned to frequency. Separate CH tables can be assigned to two or more systems (groups). Group names and CH numbers are set and displayed. Furthermore, the corresponding frequency is displayed simultaneously.																																																							
Output level	Settable range	-140 to +13 dBm (At CW, accuracy range: -136 to +6 dBm) With Mechanical Attenuator Option -140 to +19 dBm (At CW, accuracy range: -136 to +10 dBm) * Refer to Vector modulation. At vector modulation, level error in compared with CW for level accuracy at vector modulation.																																																						
	Unit	Power: dBm Voltage: dB μ V (terminate voltage display), dB μ V (open voltage display)																																																						
	Resolution	0.01 dB (dBm, dB μ V)																																																						
	Accuracy	at CW and 23 $\pm 5^\circ$ C: <table border="1"> <thead> <tr> <th rowspan="2">Level (p) [dBm]</th> <th colspan="3">Frequency (f) [Hz]</th> </tr> <tr> <th>250 k \leq f < 25 M</th> <th>25 M \leq f \leq 3 G</th> <th>3 G < f \leq 6 G*</th> </tr> </thead> <tbody> <tr> <td>+3 < p \leq +6</td> <td></td> <td>± 0.5 dB</td> <td></td> </tr> <tr> <td>-1 < p \leq +3</td> <td></td> <td>± 0.5 dB</td> <td>± 0.8 dB</td> </tr> <tr> <td>-120 \leq p \leq -1</td> <td>± 0.5 dB typ.</td> <td>± 0.5 dB</td> <td>± 0.8 dB</td> </tr> <tr> <td>-127 \leq p < -120</td> <td></td> <td>± 0.7 dB</td> <td>± 2.5 dB typ.</td> </tr> <tr> <td>-136 \leq p < -127</td> <td></td> <td>± 1.5 dB typ.</td> <td></td> </tr> </tbody> </table> * Upper frequency 6 GHz option required for 3 GHz < f \leq 6 GHz. With Mechanical Attenuator Option <table border="1"> <thead> <tr> <th rowspan="2">Level (p) [dBm]</th> <th colspan="3">Frequency (f) [Hz]</th> </tr> <tr> <th>250 k \leq f < 25 M</th> <th>25 M \leq f \leq 3 G</th> <th>3 G < f \leq 6 G*</th> </tr> </thead> <tbody> <tr> <td>+7 < p \leq +10</td> <td>± 0.5 dB typ.</td> <td>± 0.5 dB</td> <td></td> </tr> <tr> <td>-100 \leq p \leq +7</td> <td>± 0.5 dB typ.</td> <td>± 0.5 dB</td> <td>± 0.8 dB</td> </tr> <tr> <td>-120 \leq p < -100</td> <td>± 0.5 dB typ.</td> <td>± 0.5 dB</td> <td>± 1.0 dB</td> </tr> <tr> <td>-127 \leq p < -120</td> <td></td> <td>± 0.7 dB</td> <td>± 2.5 dB typ.</td> </tr> <tr> <td>-136 \leq p < -127</td> <td></td> <td>± 1.5 dB typ.</td> <td></td> </tr> </tbody> </table> * Upper frequency 6 GHz options required for "3 GHz < f \leq 6 GHz.	Level (p) [dBm]	Frequency (f) [Hz]			250 k \leq f < 25 M	25 M \leq f \leq 3 G	3 G < f \leq 6 G*	+3 < p \leq +6		± 0.5 dB		-1 < p \leq +3		± 0.5 dB	± 0.8 dB	-120 \leq p \leq -1	± 0.5 dB typ.	± 0.5 dB	± 0.8 dB	-127 \leq p < -120		± 0.7 dB	± 2.5 dB typ.	-136 \leq p < -127		± 1.5 dB typ.		Level (p) [dBm]	Frequency (f) [Hz]			250 k \leq f < 25 M	25 M \leq f \leq 3 G	3 G < f \leq 6 G*	+7 < p \leq +10	± 0.5 dB typ.	± 0.5 dB		-100 \leq p \leq +7	± 0.5 dB typ.	± 0.5 dB	± 0.8 dB	-120 \leq p < -100	± 0.5 dB typ.	± 0.5 dB	± 1.0 dB	-127 \leq p < -120		± 0.7 dB	± 2.5 dB typ.	-136 \leq p < -127		± 1.5 dB typ.	
	Level (p) [dBm]	Frequency (f) [Hz]																																																						
250 k \leq f < 25 M		25 M \leq f \leq 3 G	3 G < f \leq 6 G*																																																					
+3 < p \leq +6		± 0.5 dB																																																						
-1 < p \leq +3		± 0.5 dB	± 0.8 dB																																																					
-120 \leq p \leq -1	± 0.5 dB typ.	± 0.5 dB	± 0.8 dB																																																					
-127 \leq p < -120		± 0.7 dB	± 2.5 dB typ.																																																					
-136 \leq p < -127		± 1.5 dB typ.																																																						
Level (p) [dBm]	Frequency (f) [Hz]																																																							
	250 k \leq f < 25 M	25 M \leq f \leq 3 G	3 G < f \leq 6 G*																																																					
+7 < p \leq +10	± 0.5 dB typ.	± 0.5 dB																																																						
-100 \leq p \leq +7	± 0.5 dB typ.	± 0.5 dB	± 0.8 dB																																																					
-120 \leq p < -100	± 0.5 dB typ.	± 0.5 dB	± 1.0 dB																																																					
-127 \leq p < -120		± 0.7 dB	± 2.5 dB typ.																																																					
-136 \leq p < -127		± 1.5 dB typ.																																																						
Accuracy																																																								

Output level	Linearity	At CW, -11 dBm and at 23 ±5°C: ±0.2 dB typ (at -120 to -11 dBm, 25 MHz ≤f ≤3 GHz) ±0.3 dB typ (at -120 to -11 dBm, 3 GHz < f ≤6 GHz) With Mechanical Attenuator Option At CW, -7 dBm and at 23 ±5°C: ±0.2 dB typ (at -120 to -7 dBm, 25 MHz ≤f ≤3 GHz) ±0.3 dB typ (at -120 to -7 dBm, 3 GHz < f ≤6 GHz)
	Switching time	Response time from final command to ±0.1 dB of final level on GPIB. f < 25 MHz: ≤15 ms (Normal mode), ≤10 ms (Continuous mode) f ≥25 MHz: ≤10 ms (Not based on mode) With Mechanical Attenuator Option ≤80 ms (Normal mode), ≤10 ms (Continuous mode)
	VSWR	At ≤-11 dBm output level: 1.3 (250 kHz ≤f ≤3 GHz), 1.55 (3 GHz < f ≤6 GHz) With Mechanical Attenuator Option At ≤-7 dBm output level: 1.25 (250 kHz ≤f ≤3 GHz), 1.35 (3 GHz < f ≤6 GHz)
	Special setting mode	Continuous mode and EXT ALC mode are exclusive modes
	Continuous mode	By switching to the Continuous mode, the reference output level can be adjusted continuously in 0.01 dB steps over the range of +3 to -10 dB.
	EXT ALC mode	Output level is changed according to DC voltage input externally Variable range: -8/+3 dB, Input impedance: 600 Ω (nominal), Connector: BNC-J (rear panel, Ext. ALC)
	Output connector	50 Ω, N-J (front panel, RF Output)
Maximum reverse input	Reverse input power: 1 W _{peak} (≥300 MHz), 0.25 W _{peak} (<300 MHz), DC: 0 V With Mechanical Attenuator Option Reverse input power: 1 W _{peak} , DC: 0 V	
Signal purity	Spurious	At CW, ≤-1 dBm (With Mechanical Attenuator Option: ≤+3 dBm)
	Harmonics	<-30 dBc (f ≥300 MHz @E-ATT, f ≥250 kHz @M-ATT)
	Non harmonic	<-60 dBc (Expect the internal crossing spurious* of 2.4 GHz, 25 MHz to 3 GHz) <-54 dBc (Expect the internal crossing spurious* of 4.4 GHz, 3 to 6 GHz) *internal crossing spurious: 4.8 GHz - [output frequency] (at 25 MHz to 3 GHz), 8.8 GHz - [output frequency] (at 3 to 6 GHz)
	Power supply relation	<-50 dBc (250 kHz to 3 GHz), <-44 dBc (3 to 6 GHz)
Vector modulation	EVM	At 23 ± 5°C and Output level ≤-1 dBm (With Mechanical Attenuator Option: ≤+3 dBm) ≤2% rms., ≤1% rms typ (at W-CDMA Downlink 1code modulation, Output frequency: 800 to 1000 MHz, 1800 to 2400 MHz) At 23 ± 5°C and Output level ≤-4 dBm (With Mechanical Attenuator Option: ≤0 dBm) ≤1% rms. (at OFDM modulation equal to IEEE802.11a/g, Output frequency: 2400 to 2497 MHz, 4,900 to 5,925 MHz) ≤5% peak (at modulation equal to IEEE802.11b, Output frequency: 2,400 to 2,497 MHz)
	ACLR (5 MHz offset)	At 23 ± 5°C when using signal of W-CDMA (Test Model1 64DPCH): -61 dBc/3.84 MHz, -63 dBc/3.84 MHz typ (≤-4 dBm, 800 to 1000 MHz, 1800 to 2400 MHz) With Mechanical Attenuator Option -62 dBc/3.84 MHz, -64 dBc/3.84 MHz typ (≤0 dBm, 800 to 1000 MHz, 1800 to 2400 MHz)
	ACLR (10 MHz offset)	At 23 ± 5°C when using signal of W-CDMA (Test Model1 64DPCH): -66 dBc/3.84 MHz typ (≤-1 dBm, 800 to 1000 MHz, 1800 to 2400 MHz) With Mechanical Attenuator Option -67 dBc/3.84 MHz typ (≤+3 dBm, 800 to 1000 MHz, 1800 to 2400 MHz)
	At vector modulation, level error in comparison with CW. At modulation mode, ALC: Off	±0.2 dB [when outputting W-CDMA Downlink 1code, 1 carrier] At guaranteed range (Level) of level accuracy under following modulation conditions 50 MHz ≤f ≤3 GHz: Level ≤+2 dBm 3 GHz < f ≤6 GHz: Level ≤-1 dBm With Mechanical Attenuator Option 50 MHz ≤f ≤3 GHz: Level ≤+7 dBm 3 GHz < f ≤6 GHz: Level ≤+4 dBm
	Carrier leakage	≤-40 dBc (at 23 ± 5°C)
	Image rejection	≤-40 dBc (at 23 ± 5°C. When using complex sine wave of 10 MHz or less)
	External modulation	Input level: $\sqrt{(I^2 + Q^2)} = 0.5 \text{ V (rms.)}$, Maximum input level: -5 V (peak) ≤I, Q ≤+5 V (peak), Input impedance: 50 Ω, Input connector: BNC-J (Front panel, Modulation Input IQ)
	RF Spectrum invert	I, Q signal changeable when internal modulation. Spectrum Normal: Usual spectrum output Spectrum Reverse: Inverted spectrum output

Pulse modulation	Internal modulation	ON/OFF ratio: >60 dB, Rise/fall time: <90 ns (10 to 90%), Pulse repetition frequency: DC to 1 MHz, (Duty 50%)
	External modulation	Input range: 0 to 5 V, Input level threshold: about 1 V, ON/OFF ratio: >60 dB, Rise/Fall time: <90 ns (10 to 90%), Pulse repetition frequency: DC to 1 MHz, (Duty 50%), Input connector: 50 Ω BNC-J (rear panel, Ext Pulse Mod Input)
IQ Output	Output voltage range	When output open. Output voltage amplitude + DC offset: -3.5 to +3.5 V
	Output voltage amplitude	When output open. Amplitude change: <ul style="list-style-type: none"> • I and \bar{T} changes simultaneously • Q and \bar{Q} changes simultaneously • I/\bar{T} and Q/\bar{Q} changes independently Amplitude variable range: 0 to 120% (100% = 640 mV rms, rms = 1634) Variable step: 0.1% Accuracy: ± 0.5 dB (1-kHz sine wave, Amplitude variable range $\geq 10\%$)
	DC Offset variable range	In-phase DC offset: Variable range: -1 to +3 V, Resolution: 10 mV Differential DC offset: Variable range: -50 to +50 mV, Resolution: 50 μ V
	Output connector	50 Ω , D-Sub 15-J (rear panel, IQ Output, differential), Pin assignment (10 = I, 11 = \bar{T} , 13 = Q, 14 = \bar{Q} , other = GND)
Arbitrary function generation	Waveform resolution	14 bit
	LPF	Automatic selection and manual selection 100, 300 kHz, 1, 3, 10, 30, 70 MHz, Through
Marker output	Function	When a signal is allotted to a marker signal bit at waveform generation, up to three signals, such as pulse modulation signal (for internal modulation), frame timing signal, etc., can be output. The polarity can also be reversed.
	Number of ports	3 ports
	Connector	TTL, BNC-J (rear panel, AUX Input/Output Connector1/2/3)
Baseband reference clock signal	Internal clock signal	Range: 20 kHz to 160 MHz, Resolution: 0.001 Hz
	External clock input signal	Input frequency range: 20 kHz to 40 MHz Divide and multiply functions: Signal of 1, 2, 4, 8, 16, 1/2, 1/4, 1/8, 1/16 times of input frequency generated internally, and used as DAC sampling clock Connector: BNC-J (rear panel, Baseband Reference Clock) Input level: ≥ 0.7 V (p-p)/50 Ω (AC coupled)
Waveform memory	Memory capacity	Waveform memories. A and B. 128 Msamples/channel x 2, 256 Msamples/channel max With ARB Memory Upgrade 512 Msample option 256 Msamples/channel x 2, 512 Msamples/channel max
	Number of opened files	Up to 4096 waveform patterns opened per waveform memory (A/B) 100 packages per waveform memory, 100 patterns in one package Minimum number of samples per pattern: 1000

Waveform memory	Memory mode	<p>Defined Mode</p> <p>Selection of a single waveform pattern to be used in either waveform memory A or B, selection of waveform patterns using a combination file that defines addition of multiple waveform patterns, and the addition level ratio can be set in this mode.</p> <p>If a combination file that specifies two or more waveform patterns in waveform memory A is selected, the following sequence operations become enabled.</p> <ul style="list-style-type: none"> • Selection of pattern switching mode (Auto/Manual) • Selection of pattern switching point (Frame end/Pattern end) • Switching of pattern by an external trigger signal (enabled when the pattern switching mode is Manual) • Restart of sequence • Maximum number of elements: 200 • Minimum number of points per pattern: 1000 <p>Level ratio setting range: Two-signal level ratio <80 dB or OFF Level setting resolution: 0.01 dB Frequency offset variable width: $\pm (0.8 \times \text{Sampling Clock} \times 2^n - \text{Bandwidth})/2$ (n: Maximum integer that satisfying "Sampling Clock $\times 2^n \leq 80$ MHz when sampling clock greater than 20 MHz.) Frequency setting resolution: 1 Hz</p> <p>In this mode, two waveform memories can be connected for use as a 256 Msamples long memory (512-Msamples long when ARB Memory Upgrade 512 Msample option installed).</p> <p>Edit Mode</p> <p>One waveform each is selected from waveform memory A and waveform memory B, these two waveforms are added and then output.</p> <p>Two signal levels, the waveform memory B start offset and frequency offset, can be set.</p> <p>Level ratio setting range: Two-signal level ratio <80 dB or OFF Level setting resolution: 0.01 dB Frequency offset variable width: $\pm (0.8 \times \text{Sampling Clock} \times 2^n - \text{Bandwidth})/2$ (n: Maximum integer that satisfying Sampling Clock $\times 2^n \leq 80$ MHz when sampling clock greater than 20 MHz.) Frequency setting resolution: 1 Hz</p>
Start/Frame trigger	Function	Switchable between continuous output and burst output.
	Input connector	Functional change: Connector shared by Start trigger and Frame trigger; switched depending on situation Connector: BNC-J (Front panel, Start/Frame Trigger), Input level: TTL, Logic: Polarity Rise/Fall selected
	Start trigger	Starts waveform output
	Frame trigger	Searches for burst timing at burst output Burst length data output and timing of frame trigger and waits for next frame trigger
Pattern trigger	Function	When using the sequence mode, the pattern trigger will force a pattern switch
	Input connector	Connector: Front panel, Pattern Trigger, BNC-J connector Input level: TTL Logic: Rising or falling polarity
BER Measurement function (Standard)	Function	BER Measurement of demodulated data sequence
	Input connector	TTL, BNC-J (rear panel, BER Input)
	Input signal	Data, Clock, Enable (Polarity reversal supported.)
	Input level	TTL
	Input threshold level	Matches threshold (0.8 to 2.4 V) of TTL
	Input bit rate	1 kbps to 20 Mbps
	Measurable patterns	PN 9, 11, 15, 20, 23, ALL0, ALL1, ALT (alternating 0 and 1)
	Measurable BER	0% to 1% (Reference value; changes with system conditions and data rate)
	Measurable time	≤ 359999.0 sec
	Mode	Single, Endless, Continuous
	Display	BitError, SyncLoss, ClockError, EnableError, Error Rate, Error Count
	Auto Resync function	Switched between enable/disable

BER Measurement function (Option: MG3700A-031, MG3700A-131)	Function	BER Measurement of demodulated data
	Connector	Rear panel, BER Input, BNC-J connector
	Input signal	Data, Clock, Enable (Polarity reversal supported)
	Input level	0 to 5 V
	Input threshold level	0.20 to 3.00 V (0.05 V step)
	Input impedance	50 Ω, High impedance
	Adjustable range of input timing	-1 to 15 clock (Data/Enable adjusted for input Clock)
	Input bit rate	100 bps to 120 Mbps
	Measurable patterns	PN 9, 11, 15, 20, 23, ALL0, ALL1, ALT (alternating 0 and 1) PN 9fix, 11fix, 15fix, 20fix, 23fix, UserDefine
	Measurable BER	0 to 10% (Reference value; changes with system conditions and data rate)
	Measurable bit count	1000 to 4294967295 ($2^{32} - 1$) bit
	Measurable error bit	1 to 2147483647 ($2^{31} - 1$) bit
	Auto Resync	ON/OFF: Select ON when SyncLoss and Threshold error detecting is used to control the measurement cycle. Measurement will stop when the SyncLoss or Threshold error criteria is satisfied. Select OFF when SyncLoss and Threshold error detecting is not to be performed. Threshold setting range: [numerator/denominator] Choose from denominator = 500, 5000, 50000, numerator = 1 to denominator/2, (Default: 200/500)
Measurement mode	Single, Continuous, Endless	
Display	BitError, SyncLoss, ClockError, Enable Error, SyncLoss Count, Overflow Data Count, Overflow SyncLoss, Error Rate, Error Count	
External interface	GPIB	Control target: All functions except MAIN PWR switch, [Local] key, and screen contrast keys. Interface: SH1, AH1, T6, L4, TE0, SR1, RL1, PP0, DC1, DT1, C0, E2 Connector: GPIB (rear panel, GPIB)
	100BASE-TX Ethernet	Function: Waveform pattern transfer and control. Connector: RJ45 jack (front panel and rear panel, Ethernet) In order to use the Ethernet jack on the front panel, it is necessary to jumper the two Ethernet jacks on the rear panel using the straight-through cable (standard accessory).
	Memory card	Function: Waveform pattern, memory parameters, software, and CH table can be saved or recalled to/from CompactFlash card Connector: Slot (front panel, CF Card)
Display	Size	8.4 inch, 640 x 480 dots, color TFT LCD
	On/Off setting	Panel display On/Off
	Screen save	Currently displayed screen saved to HDD/CF card as bitmap file
Power Supply	Voltage	100 to 120 V, 200 to 240 Vac (-15/+10%, 250 V MAX)
	Frequency	47.5 to 63 Hz
	Power consumption	≤200 VA
	Operating temperature	+5° to +45°C
	Storage temperature	-20° to +60°C
Dimensions and mass	426 (W) x 177 (H) x 451 (D) mm, ≤15 kg (excluding option)	
EMC	EN61326 EN61000-3-2	
LVD	EN61010-1	

Configuration Guide

The MG3700A Vector Signal Generator supports a variety of general hardware and software as standard equipment. Use the chart below to select options when higher performance than provided by the standard configuration is desired.

Classification	Outline	Standard	Option	Note
Frequency range	250 kHz to 3 GHz	✓		
	250 kHz to 6 GHz		✓	6 GHz Frequency Extension Option
Reference oscillator	Standard	✓		Frequency: 10 MHz, Aging rate: $\pm 1 \times 10^{-8}$ /day, $\pm 1 \times 10^{-7}$ /year
	Rubidium Reference Oscillator		✓	Rubidium Reference Oscillator Option Frequency: 10 MHz, Aging rate: $\pm 1 \times 10^{-10}$ /Month
Attenuator	Electron Attenuator	✓		
	Mechanical Attenuator		✓	Mechanical Attenuator Option Changes electronic attenuator to mechanical attenuator
Memory	1 GB = 256 Msamples/channel	✓		128 Msamples/channel x 2 Maximum of 256 Msamples/channel
	2 GB = 512 Msamples/channel		✓	ARB Memory Upgrade 512 Msample Option 256 Msamples/channel x 2 Maximum of 512 Msamples/channel
Baseband generator	Internal/External	✓		Vector modulation bandwidth (Internal): 120 MHz Vector modulation bandwidth (External): 150 MHz
BER Analyzer		✓		Input bit rate: 1 kbps to 20 Mbps Measurable Patterns: PN 9/11/15/20/23, ALL0, ALL1, repetition of 0 and 1
			✓	High speed BER Test function Input bit rate: 100 bps to 120 Mbps Measurable Patterns: PN 9/11/15/20/23, ALL0, ALL1, repetition of 0 and 1 PN9fix/11fix/15fix/20fix/23fix, UserDefine
Hard disk	40 GB	✓		Hard disk for saving waveform patterns and parameters
Waveform patterns software*	W-CDMA	✓		Waveform patterns saved hard disk License required
	GSM/EDGE	✓		
	CDMA2000 1X/1xEV-DO	✓		
	W-LAN (IEEE802.11a/b/g)	✓		
	PDC	✓		
	PHS	✓		
	Bluetooth	✓		
	GPS	✓		
	Digital Broadcast (ISDB-T 1 segment, BS, CS, CATV)	✓		
	AWGN	✓		
			✓	License required (Model: MX370001A)
			✓	License required (Model: MX370002A)
IQproducer License for each system*	HSDPA/HSUPA		✓	License required (Model: MX370101A)
	Universal TDMA		✓	License required (Model: MX370102A)
	CDMA2000 1xEV-DO		✓	License required (Model: MX370103A)
	Multi-carrier		✓	License required (Model: MX370104A)
	Mobile WiMAX		✓	License required (Model: MX370105A)
	DVB-T/H		✓	License required (Model: MX370106A)
	Fading		✓	License required (Model: MX370107A)
			✓	License required (Model: MX370108A)
IQproducer (PC application software)*	Parameter setting function	✓		Various parameters of waveform pattern edited easily Parameter edit results saved as a setting file and can recalled
	Data converter function	✓		Setting files converted to MG3700A waveform pattern License required for each system Setting file programmed in C or MATLAB converted to a waveform pattern without license
	Data transfer function	✓		Waveform patterns, display copy files, and update programs transferred from PC to MG3700A via Ethernet
	Simulator function	✓		For checking waveform pattern before transferring to MG3700A
Warranty service	1 year	✓		
	2 years		✓	Standard 1 year + 1 year
	3 years		✓	Standard 1 year + 2 years
	5 years		✓	Standard 1 year + 4 years

*: Read the waveform pattern and IQproducer data sheet for details.

Ordering Information

Please specify model/order number, name, and quantity when ordering.

The names listed in the chart below are Order Names. The actual name of the item may differ from the Order Name.

Model/Order No.	Name	Remarks
MG3700A	— Main frame — Vector Signal Generator	
	— Standard accessories —	
J0017F	Power Cord, 2.6 m: 1 pc	
J1276	LAN Straight Cable: 1 pc	10 cm, For U link connection on Rear panel
	CompactFlash: 1 pc	64 MB or more
J1254	CompactFlash Adapter: 1 pc	
Z0742	MG3700A CD-ROM: 1 pc	Main frame operation manual, IQproducer operation manual, Standard waveform operation manual, IQproducer software
	— Options —	
MG3700A-001	Rubidium Reference Oscillator	Aging rate: $\pm 1 \times 10^{-10}$ /Month
MG3700A-002	Mechanical Attenuator	Changes standard electronic attenuator to mechanical attenuator
MG3700A-011	Upper Frequency 6 GHz	250 kHz to 3 GHz extended to 250 kHz to 6 GHz
MG3700A-021	ARB Memory Upgrade 512 Msample	Extends standard 128 Msample/channel x 2 to 256 Msample/channel x 2
MG3700A-031	High Speed BER Test Function	Extends standard BER test function
MG3700A-101	Rubidium Reference Oscillator Retrofit	Retrofitted to shipped MG3700A
MG3700A-102	Mechanical Attenuator Retrofit	Retrofitted to shipped MG3700A
MG3700A-103	Electronic Attenuator Retrofit	Retrofitted to shipped MG3700A
MG3700A-111	Upper Frequency 6 GHz Retrofit	Retrofitted to shipped MG3700A
MG3700A-121	ARB Memory Upgrade 512 Msample Retrofit	Retrofitted to shipped MG3700A
MG3700A-131	High Speed BER Test Function Retrofit	Retrofitted to shipped MG3700A
	— Maintenance service —	
MG3700A-ES210	Extended Warranty Service	2 years
MG3700A-ES310	Extended Warranty Service	3 years
MG3700A-ES510	Extended Warranty Service	5 years
	— Softwares (Waveform pattern) —	
MX370001A	TD-SCDMA Waveform Pattern	
MX370002A	Public Radio System Waveform Pattern	RCR STD-39, ARIB STD-T61/T79/T86
	— Softwares (License key for IQproducer system) —	
MX370101A	HSDPA/HSUPA IQproducer	
MX370102A	TDMA IQproducer	
MX370103A	CDMA2000 1xEV-DO IQproducer	
MX370104A	Multi-carrier IQproducer	
MX370105A	Mobile WiMAX IQproducer	
MX370106A	DVB-T/H IQproducer	
MX370107A	Fading IQproducer	
MX370108A	LTE IQproducer	
	— Optional accessories —	
Z0777	Standard Waveform Pattern Upgrade Kit	(DVD 4 piece sets)
W2495AE	MG3700A Operation Manual	
W2496AE	MG3700A IQproducer Operation Manual	
W2539AE	MG3700A Standard Waveform Pattern Operation Manual	
W2533AE	MX370001A TD-SCDMA Waveform Pattern Operation Manual	
W2503AE	MX370101A HSDPA/HSUPA IQproducer Operation Manual	
W2504AE	MX370102A TDMA IQproducer Operation Manual	
W2505AE	MX370103A CDMA2000 1xEV-DO IQproducer Operation Manual	
W2633AE	MX370104A Multi-carrier IQproducer Operation Manual	
W2734AE	MX370105A Mobile WiMAX IQproducer Operation Manual	
W2798AE	MX370106A DVB-T/H IQproducer Operation Manual	
W2995AE	MX370107A Fading IQproducer Operation Manual	
W3022AE	MX370108A LTE IQproducer Operation Manual	
G0141	HDD ASSY	Hard disk
K240B	Power Divider (K connector)	DC to 26.5 GHz, K-J, 50 Ω , 1 Wmax
MA1612A	Four-Port Junction Pad	5 MHz to 3 GHz, N-J
MP752A	Termination	DC to 12.4 GHz, 50 Ω , N-P
MA2512A	Band Pass Filter	For W-CDMA, pass band: 1.92 to 2.17 GHz
J0576B	Coaxial Cord, 1.0 m	N-P • 5D-2W • N-P
J0576D	Coaxial Cord, 2.0 m	N-P • 5D-2W • N-P
J0127A	Coaxial Cord, 1.0 m	BNC-P • RG-58A/U • BNC-P
J0127B	Coaxial Cord, 2.0 m	BNC-P • RG-58A/U • BNC-P
J0127C	Coaxial Cord, 0.5 m	BNC-P • RG-58A/U • BNC-P

Model/Order No.	Name	Remarks
J0322A	Coaxial Cord, 0.5 m	SMA-P • SMA-P, DC to 18 GHz, 50 Ω
J0322B	Coaxial Cord, 1.0 m	SMA-P • SMA-P, DC to 18 GHz, 50 Ω
J0322C	Coaxial Cord, 1.5 m	SMA-P • SMA-P, DC to 18 GHz, 50 Ω
J0322D	Coaxial Cord, 2.0 m	SMA-P • SMA-P, DC to 18 GHz, 50 Ω
J0004	Coaxial Adapter	N-P • SMA-J Conversion Adapter, DC to 12.4 GHz
J1261B	Ethernet Cable (Shield Type)	Straight-through, 3 m
J1261D	Ethernet Cable (Shield Type)	Cross, 3 m
J0008	GPIB Cable, 2.0 m	
J1277	IQ Output Conversion Adapter	D-Sub/BNC
B0329C	Front Cover for 1MW 4U	
B0331C	Front Panel Handle Kit	2 pcs/set
B0332	Joint Plate	4 pcs/set
B0333C	Rack Mount Kit	
B0334C	Hardtype Carrying Case	With front cover and a casters
P0021	CompactFlash 128 MB	
P0022	CompactFlash 256 MB	
P0023	CompactFlash 512 MB	

Typical (typ):

Performance not warranted. Must products meet typical performance.

Nominal:

Values not warranted. Included to facilitate application of product.

Example:

Performance not warranted. Data actually measured by randomly selected measuring instruments.

Trademarks:

- IQproducer™ is a registered trademark of Anritsu Corporation.
- MATLAB® is a registered trademark of The MathWorks, Inc.
- CDMA2000® is a registered trademark of the Telecommunications Industry Association (TIA-USA).
- Bluetooth® and related logomarks are owned by Bluetooth SIG, Inc. and are used by Anritsu under license.
- Pentium® is registered trademarks of Intel Corporation or its subsidiaries in the USA and other countries.
- Windows® is a registered trademark of Microsoft Corporation in the USA and other countries.
- CompactFlash® is a registered trademark of SanDisk Corporation in the USA and is licensed to the CFA (Compact Flash Association).
- Other companies, product names and service names are registered trademarks of their respective companies.



Note:

Anritsu Corporation

5-1-1 Onna, Atsugi-shi, Kanagawa, 243-8555 Japan
Phone: +81-46-223-1111
Fax: +81-46-296-1264

● U.S.A.

Anritsu Company

1155 East Collins Blvd., Suite 100, Richardson,
TX 75081, U.S.A.
Toll Free: 1-800-267-4878
Phone: +1-972-644-1777
Fax: +1-972-671-1877

● Canada

Anritsu Electronics Ltd.

700 Silver Seven Road, Suite 120, Kanata,
Ontario K2V 1C3, Canada
Phone: +1-613-591-2003
Fax: +1-613-591-1006

● Brazil

Anritsu Eletrônica Ltda.

Praca Amadeu Amaral, 27 - 1 Andar
01327-010-Paraiso-São Paulo-Brazil
Phone: +55-11-3283-2511
Fax: +55-11-3288-6940

● Mexico

Anritsu Company, S.A. de C.V.

Av. Ejército Nacional No. 579 Piso 9, Col. Granada
11520 México, D.F., México
Phone: +52-55-1101-2370
Fax: +52-55-5254-3147

● U.K.

Anritsu EMEA Ltd.

200 Capability Green, Luton, Bedfordshire, LU1 3LU, U.K.
Phone: +44-1582-433200
Fax: +44-1582-731303

● France

Anritsu S.A.

16/18 avenue du Québec-SILIC 720
91961 COURTABOEUF CEDEX, France
Phone: +33-1-60-92-15-50
Fax: +33-1-64-46-10-65

● Germany

Anritsu GmbH

Nemetschek Haus, Konrad-Zuse-Platz 1
81829 München, Germany
Phone: +49-89-442308-0
Fax: +49-89-442308-55

● Italy

Anritsu S.p.A.

Via Elio Vittorini 129, 00144 Roma, Italy
Phone: +39-6-509-9711
Fax: +39-6-502-2425

● Sweden

Anritsu AB

Borgafjordsgatan 13, 164 40 KISTA, Sweden
Phone: +46-8-534-707-00
Fax: +46-8-534-707-30

● Finland

Anritsu AB

Teknobulevardi 3-5, FI-01530 VANTAA, Finland
Phone: +358-20-741-8100
Fax: +358-20-741-8111

● Denmark

Anritsu A/S

Kirkebjerg Allé 90, DK-2605 Brøndby, Denmark
Phone: +45-72112200
Fax: +45-72112210

● Spain

Anritsu EMEA Ltd.

Oficina de Representación en España

Edificio Veganova
Avda de la Vega, n° 1 (edf 8, pl 1, of 8)
28108 ALCOBENDAS - Madrid, Spain
Phone: +34-914905761
Fax: +34-914905762

● United Arab Emirates

Anritsu EMEA Ltd.

Dubai Liaison Office

P O Box 500413 - Dubai Internet City
Al Thuraya Building, Tower 1, Suit 701, 7th Floor
Dubai, United Arab Emirates
Phone: +971-4-3670352
Fax: +971-4-3688460

● Singapore

Anritsu Pte. Ltd.

60 Alexandra Terrace, #02-08, The Comtech (Lobby A)
Singapore 118502
Phone: +65-6282-2400
Fax: +65-6282-2533

● India

Anritsu Pte. Ltd.

India Branch Office

Unit No. S-3, Second Floor, Esteem Red Cross Bhavan,
No. 26, Race Course Road, Bangalore 560 001, India
Phone: +91-80-32944707
Fax: +91-80-22356648

● P.R. China (Hong Kong)

Anritsu Company Ltd.

Units 4 & 5, 28th Floor, Greenfield Tower, Concordia Plaza,
No. 1 Science Museum Road, Tsim Sha Tsui East,
Kowloon, Hong Kong
Phone: +852-2301-4980
Fax: +852-2301-3545

● P.R. China (Beijing)

Anritsu Company Ltd.

Beijing Representative Office

Room 1515, Beijing Fortune Building,
No. 5, Dong-San-Huan Bei Road,
Chao-Yang District, Beijing 10004, P.R. China
Phone: +86-10-6590-9230
Fax: +86-10-6590-9235

● Korea

Anritsu Corporation, Ltd.

8F Hyunjuk Building, 832-41, Yeoksam Dong,
Kangnam-ku, Seoul, 135-080, Korea
Phone: +82-2-553-6603
Fax: +82-2-553-6604

● Australia

Anritsu Pty. Ltd.

Unit 21/270 Ferntree Gully Road, Notting Hill,
Victoria 3168, Australia
Phone: +61-3-9558-8177
Fax: +61-3-9558-8255

● Taiwan

Anritsu Company Inc.

7F, No. 316, Sec. 1, Neihu Rd., Taipei 114, Taiwan
Phone: +886-2-8751-1816
Fax: +886-2-8751-1817

Please Contact: